



ECS4110-28T/28P/52T/52P
28/52-Port Gigabit Ethernet
Layer 2+ Switch

Management Guide

ECS4110-28T GIGABIT ETHERNET SWITCH

*Layer 2+ Managed Switch
with 24 10/100/1000BASE-T (RJ-45) Ports,
and 4 Gigabit SFP Ports*

ECS4110-28P GIGABIT ETHERNET POE SWITCH

*Layer 2+ Managed Switch
with 24 10/100/1000BASE-T (RJ-45) PoE Ports,
and 4 Gigabit SFP Ports*

ECS4110-52T GIGABIT ETHERNET SWITCH

*Layer 2+ Managed Switch
with 48 10/100/1000BASE-T (RJ-45) Ports,
and 4 Gigabit SFP Ports*

ECS4110-52P GIGABIT ETHERNET POE SWITCH

*Layer 2+ Managed Switch
with 48 10/100/1000BASE-T (RJ-45) PoE Ports,
and 4 Gigabit SFP Ports*

ABOUT THIS GUIDE

PURPOSE This guide gives specific information on how to operate and use the management functions of the switch.

AUDIENCE The guide is intended for use by network administrators who are responsible for operating and maintaining network equipment; consequently, it assumes a basic working knowledge of general switch functions, the Internet Protocol (IP), and Simple Network Management Protocol (SNMP).

CONVENTIONS The following conventions are used throughout this guide to show information:



NOTE: Emphasizes important information or calls your attention to related features or instructions.



CAUTION: Alerts you to a potential hazard that could cause loss of data, or damage the system or equipment.



WARNING: Alerts you to a potential hazard that could cause personal injury.

RELATED PUBLICATIONS The following publication details the hardware features of the switch, including the physical and performance-related characteristics, and how to install the switch:

The Installation Guide

Also, as part of the switch's software, there is an online web-based help that describes all management related features.

REVISION HISTORY This section summarizes the changes in each revision of this guide.

JULY 2014 RELEASE

This is the second version of this guide. This guide is valid for software release v1.1.2.0. It includes information on the following changes:

- ◆ Adds information for the ECS4110-28T and ECS4110-28P.
- ◆ Updated information in [Table 1, "Key Features,"](#) on page 75.
- ◆ Updated information under "Description of Software Features" on [page 76](#).
- ◆ Updated information in [Table 2, "System Defaults,"](#) on page 82.
- ◆ Updated information in [Table 6, "Switch Main Menu,"](#) on page 106.
- ◆ Added the section "Configuring NTP" on page 139.
- ◆ Added the section "Configuring Time Servers" on page 140.
- ◆ Updated description of Media Type under "Configuring by Port List" on [page 156](#).
- ◆ Added the section "Displaying Transceiver Data" on page 170.
- ◆ Added Timeout Mode under "Configuring a Dynamic Trunk" on page 179.
- ◆ Added the section "Configuring Load Balancing" on page 189.
- ◆ Updated information under "Traffic Segmentation" on page 193.
- ◆ Added description of L3 Interface parameter under "Configuring VLAN Groups" on page 202.
- ◆ Added description of Mask parameter under "Configuring MAC-based VLANs" on page 227.
- ◆ Added the section "Configuring MAC Address Learning" on page 231.
- ◆ Updated the parameter list under "Configuring Loopback Detection" on [page 242](#).
- ◆ Added description of BPDU Flooding and Cisco Prestandard Status parameters under "Configuring Global Settings for STA" on page 243.
- ◆ Added description of BPDU Flooding and Admin Edge Port parameters under "Configuring Interface Settings for STA" on page 250.
- ◆ Updated the parameter list under "Configuring a Class Map" on [page 288](#).
- ◆ Updated the parameter list under "Configuring Local/Remote Logon Authentication" on page 311.

- ◆ Updated the parameter list under "Configuring AAA Accounting" on page 317.
- ◆ Updated the parameter list under "Configuring AAA Authorization" on page 323.
- ◆ Updated description of the Access Level parameter under "Configuring User Accounts" on page 326.
- ◆ Added the section "Setting a Time Range" on page 353.
- ◆ Updated description of Source Address Type and Destination Address Type parameters under "Configuring an Extended IPv6 ACL" on page 365.
- ◆ Added Internet Protocol parameter under "Configuring a MAC ACL" on page 367.
- ◆ Added the section "Configuring ACL Mirroring" on page 372.
- ◆ Added the section "Showing ACL Hardware Counters" on page 374.
- ◆ Added the parameter Allow Zeros under "Configuring Global Settings for ARP Inspection" on page 376.
- ◆ Updated parameter list under "Configuring Port Security" on page 385.
- ◆ Added the parameter Re-authentication Max Retries under "Configuring Port Authenticator Settings for 802.1X" on page 390.
- ◆ Updated the parameter list for "DoS Protection" on page 399.
- ◆ Added the section "IPv6 Source Guard" on page 406.
- ◆ Updated the parameter list for "DHCP Snooping Global Configuration" on page 415.
- ◆ Added the Circuit ID parameter under "Configuring Ports for DHCP Snooping" on page 417.
- ◆ Added description of time range parameters under "Setting the Port PoE Power Budget" on page 450.
- ◆ Updated Table 34, "Supported Notification Messages," on page 462.
- ◆ Added the section "Creating SNMP Notification Logs" on page 476 and "Showing SNMP Statistics" on page 478.
- ◆ Added the sections "Ethernet Ring Protection Switching" on page 495, "Connectivity Fault Management" on page 520, and "OAM Configuration" on page 556.
- ◆ Added the Forwarding Priority parameter under "Configuring IGMP Snooping and Query Parameters" on page 570.

- ◆ Added the sections "Filtering IGMP Query Packets and Multicast Data" on page 584 and "Displaying IGMP Snooping Statistics" on page 586.
- ◆ Added the section "MLD Snooping (Snooping and Query for IPv6)" on page 595.
- ◆ Added the section "Configuring MVR Global Settings" on page 605.
- ◆ Updated the parameter list under "Configuring MVR Domain Settings" on page 607.
- ◆ Added the section "Configuring MVR Group Address Profiles" on page 608.
- ◆ Updated the parameter list under "Configuring MVR Interface Status" on page 611.
- ◆ Updated the parameter list under "Displaying MVR Receiver Groups" on page 616.
- ◆ Added the section "Displaying MVR Statistics" on page 617.
- ◆ Added the section "Multicast VLAN Registration for IPv6" on page 621.
- ◆ Added new parameters under "Configuring IPv6 Interface Settings" on page 644.
- ◆ Added the section "Specifying a DHCP Client Identifier" on page 669.
- ◆ Added the section "Configuring DHCP Relay Service" on page 671.
- ◆ Added the section "Using the Trace Route Function" on page 684.
- ◆ Added the sections "Configuring Static Routes" on page 691 and "Displaying the Routing Table" on page 693.
- ◆ Updated syntax for the command "show running-config" on page 729.
- ◆ Added the commands "show watchdog" on page 734 and "watchdog software" on page 735.
- ◆ Updated syntax for the command "copy" on page 738.
- ◆ Updated syntax for the command "delete" on page 741.
- ◆ Added the command "upgrade opcode reload" on page 745.
- ◆ Added "TFTP Configuration Commands" on page 746.
- ◆ Updated syntax for the command "logging host" on page 761
- ◆ Added "NTP Commands" on page 773.

- ◆ Added the commands "clock summer-time (date)" on page 777, "clock summer-time (predefined)" on page 778, and "clock summer-time (recurring)" on page 779.
- ◆ Updated syntax for the command "snmp-server enable traps" on page 798.
- ◆ Added the commands "snmp-server enable port-traps mac-notification" on page 801 and "show snmp-server enable port-traps" on page 802.
- ◆ Updated description of syntax for the commands "enable password" on page 824 and "username" on page 825.
- ◆ Added commands "privilege" on page 827 and "show privilege" on page 827.
- ◆ Added the commands "tacacs-server retransmit" on page 836 and "tacacs-server timeout" on page 837.
- ◆ Added the command "accounting commands" on page 844.
- ◆ Updated syntax for the command "show accounting" on page 846
- ◆ Added the command "dot1x max-reauth-req" on page 866.
- ◆ Added the section "PPPoE Intermediate Agent" on page 880.
- ◆ Added the commands "mac-learning" on page 890, "port security mac-address-as-permanent" on page 893, and ".show port security" on page 893.
- ◆ Updated syntax and description for the command "ip dhcp snooping information option" on page 918.
- ◆ Added the command "ip dhcp snooping limit rate" on page 920.
- ◆ Added the command "ip dhcp snooping information option circuit-id" on page 922.
- ◆ Added the command "clear ip dhcp snooping binding" on page 924.
- ◆ Added the section "DHCPv6 Snooping" on page 926.
- ◆ Updated syntax for "ip source-guard binding" on page 936 and "ip source-guard max-binding" on page 939.
- ◆ Added the command "ip source-guard mode" on page 940.
- ◆ Added the command "clear ip source-guard binding blocked" on page 941.
- ◆ Updated syntax for "show ip source-guard binding" on page 942.
- ◆ Added the section "IPv6 Source Guard" on page 943.

- ◆ Added allow-zeros parameter to the command "ip arp inspection validate" on page 952.
- ◆ Added new commands under the section "Denial of Service Protection" on page 957.
- ◆ Added new commands under the section "Port-based Traffic Segmentation" on page 963.
- ◆ Added counter parameter to the commands "ip access-group" on page 975, "ipv6 access-group" on page 981, and "mac access-group" on page 987.
- ◆ Updated syntax for the command "permit, deny (MAC ACL)" on page 984.
- ◆ Updated syntax for the command "show access-group" on page 992.
- ◆ Added the commands "discard" on page 999 and "show discard" on page 1004.
- ◆ Updated syntax for the command "media-type" on page 1001.
- ◆ Added commands under "Transceiver Threshold Configuration" on page 1009.
- ◆ Added the commands "port channel load-balance" on page 1022, "lacp timeout" on page 1029, and "show port-channel load-balance" on page 1033.
- ◆ Added the commands "power mainpower maximum allocation" on page 1036 and "show power mainpower" on page 1042.
- ◆ Added access-list parameter to the command "port monitor" on page 1045.
- ◆ Added the command "spanning-tree system-bpdu-flooding" on page 1099.
- ◆ Updated description for the command "spanning-tree bpdu-filter" on page 1103.
- ◆ Updated description for the command "spanning-tree bpdu-guard" on page 1104.
- ◆ Added block parameter to the command "spanning-tree loopback-detection action" on page 1108.
- ◆ Added the command "spanning-tree port-bpdu-flooding" on page 1112 and "spanning-tree tc-prop-stop" on page 1114.
- ◆ Updated syntax for the command "show spanning-tree" on page 1116.
- ◆ Added the chapter "ERPS Commands" on page 1119.

- ◆ Included information for configuring a Layer 3 interface with the command ["interface vlan" on page 1157](#).
- ◆ Added the command ["switchport dot1q-tunnel service match cvid" on page 1168](#).
- ◆ Updated syntax for the command ["show dot1q-tunnel" on page 1171](#).
- ◆ Added the section ["Configuring L2CP Tunneling" on page 1172](#).
- ◆ Added the section ["Configuring VLAN Translation" on page 1176](#).
- ◆ Added priority parameter to the command ["protocol-vlan protocol-group \(Configuring Interfaces\)" on page 1180](#).
- ◆ Added mask parameter to the command ["mac-vlan" on page 1185](#).
- ◆ Changed command mode to Global Configuration for the commands ["qos map cos-dscp" on page 1200](#), ["qos map dscp-mutation" on page 1202](#), and ["qos map phb-queue" on page 1203](#).
- ◆ Updated syntax for the command ["show qos map cos-dscp" on page 1205](#), ["show qos map dscp-mutation" on page 1205](#), and ["show qos map phb-queue" on page 1206](#).
- ◆ Updated syntax for the commands ["class-map" on page 1208](#) and ["match" on page 1210](#).
- ◆ Added the commands ["ip igmp snooping priority" on page 1228](#), ["clear ip igmp snooping groups dynamic" on page 1242](#), ["clear ip igmp snooping statistics" on page 1243](#), ["show ip igmp snooping group" on page 1244](#), and ["show ip igmp snooping statistics" on page 1246](#).
- ◆ Added the commands ["ip igmp authentication" on page 1253](#), ["show ip igmp authentication" on page 1258](#), ["ip igmp query-drop" on page 1257](#), ["show ip igmp query-drop" on page 1260](#), ["ip multicast-data-drop" on page 1257](#), and ["show ip multicast-data-drop" on page 1261](#).
- ◆ Added the sections ["MLD Snooping" on page 1262](#), and ["MLD Filtering and Throttling" on page 1272](#).
- ◆ Modified command set under ["MVR for IPv4" on page 1281](#).
- ◆ Added the section ["MVR for IPv6" on page 1303](#).
- ◆ Added the commands ["lldp dot3-tlv mac-phy" on page 1335](#), ["lldp dot3-tlv poe" on page 1336](#), and ["lldp med-tlv ext-poe" on page 1339](#).
- ◆ Updated syntax for the command ["ip address" on page 1422](#),
- ◆ Added the commands ["ipv6 mtu" on page 1441](#) and ["show ipv6 mtu" on page 1444](#).

- ◆ Added the command "tracert6" on page 1450.
- ◆ Added the commands "ipv6 nd dad attempts" on page 1452, "ipv6 nd raguard" on page 1454, "show ipv6 nd raguard" on page 1456, and "ipv6 nd reachable-time" on page 1455.
- ◆ Added the section "ND Snooping" on page 1458.
- ◆ Added the chapter "IP Routing Commands" on page 1467.

JANUARY 2013 RELEASE

This is the first version of this guide. This guide is valid for software release v1.0.0.0.

CONTENTS

ABOUT THIS GUIDE	5
CONTENTS	13
FIGURES	51
TABLES	65

SECTION I	GETTING STARTED	73
	1 INTRODUCTION	75
	Key Features	75
	Description of Software Features	76
	System Defaults	82
	2 INITIAL SWITCH CONFIGURATION	85
	Connecting to the Switch	85
	Configuration Options	85
	Required Connections	86
	Remote Connections	87
	Basic Configuration	87
	Console Connection	87
	Setting Passwords	88
	Setting an IP Address	89
	Downloading a Configuration File Referenced by a DHCP Server	95
	Enabling SNMP Management Access	96
	Managing System Files	99
	Saving or Restoring Configuration Settings	99

SECTION II	WEB CONFIGURATION	101
	3 USING THE WEB INTERFACE	103
	Connecting to the Web Interface	103

Navigating the Web Browser Interface	104
Home Page	104
Configuration Options	105
Panel Display	105
Main Menu	106
4 BASIC MANAGEMENT TASKS	123
Displaying System Information	123
Displaying Hardware/Software Versions	125
Configuring Support for Jumbo Frames	126
Displaying Bridge Extension Capabilities	127
Managing System Files	129
Copying Files via FTP/TFTP or HTTP	129
Saving the Running Configuration to a Local File	131
Setting the Start-Up File	132
Showing System Files	132
Automatic Operation Code Upgrade	133
Setting the System Clock	137
Setting the Time Manually	137
Setting the SNTP Polling Interval	138
Configuring NTP	139
Configuring Time Servers	140
Setting the Time Zone	144
Configuring the Console Port	145
Configuring Telnet Settings	146
Displaying CPU Utilization	148
Displaying Memory Utilization	149
Resetting the System	150
5 INTERFACE CONFIGURATION	155
Port Configuration	156
Configuring by Port List	156
Configuring by Port Range	158
Displaying Connection Status	159
Configuring Local Port Mirroring	160
Configuring Remote Port Mirroring	162
Showing Port or Trunk Statistics	166
Displaying Transceiver Data	170

Configuring Transceiver Thresholds	172
Performing Cable Diagnostics	174
Trunk Configuration	176
Configuring a Static Trunk	177
Configuring a Dynamic Trunk	179
Displaying LACP Port Counters	185
Displaying LACP Settings and Status for the Local Side	187
Displaying LACP Settings and Status for the Remote Side	188
Configuring Load Balancing	189
Saving Power	191
Traffic Segmentation	193
Enabling Traffic Segmentation	193
Configuring Uplink and Downlink Ports	194
VLAN Trunking	196
6 VLAN CONFIGURATION	199
IEEE 802.1Q VLANs	199
Configuring VLAN Groups	202
Adding Static Members to VLANs	205
Configuring Dynamic VLAN Registration	209
IEEE 802.1Q Tunneling	212
Enabling QinQ Tunneling on the Switch	216
Creating CVLAN to SPVLAN Mapping Entries	217
Adding an Interface to a QinQ Tunnel	219
Protocol VLANs	220
Configuring Protocol VLAN Groups	221
Mapping Protocol Groups to Interfaces	222
Configuring IP Subnet VLANs	225
Configuring MAC-based VLANs	227
Configuring VLAN Mirroring	229
7 ADDRESS TABLE SETTINGS	231
Configuring MAC Address Learning	231
Setting Static Addresses	233
Changing the Aging Time	234
Displaying the Dynamic Address Table	235
Clearing the Dynamic Address Table	236
Configuring MAC Address Mirroring	237

8	SPANNING TREE ALGORITHM	239
	Overview	239
	Configuring Loopback Detection	242
	Configuring Global Settings for STA	243
	Displaying Global Settings for STA	249
	Configuring Interface Settings for STA	250
	Displaying Interface Settings for STA	254
	Configuring Multiple Spanning Trees	257
	Configuring Interface Settings for MSTP	261
9	CONGESTION CONTROL	263
	Rate Limiting	263
	Storm Control	264
	Automatic Traffic Control	266
	Setting the ATC Timers	268
	Configuring ATC Thresholds and Responses	269
10	CLASS OF SERVICE	273
	Layer 2 Queue Settings	273
	Setting the Default Priority for Interfaces	273
	Selecting the Queue Mode	274
	Mapping CoS Values to Egress Queues	277
	Layer 3/4 Priority Settings	279
	Setting Priority Processing to DSCP or CoS	280
	Mapping Ingress DSCP Values to Internal DSCP Values	281
	Mapping CoS Priorities to Internal DSCP Values	283
11	QUALITY OF SERVICE	287
	Overview	287
	Configuring a Class Map	288
	Creating QoS Policies	291
	Attaching a Policy Map to a Port	301
12	VOIP TRAFFIC CONFIGURATION	303
	Overview	303
	Configuring VoIP Traffic	304
	Configuring Telephony OUI	305
	Configuring VoIP Traffic Ports	306

13 SECURITY MEASURES	309
AAA Authentication, Authorization and Accounting	310
Configuring Local/Remote Logon Authentication	311
Configuring Remote Logon Authentication Servers	312
Configuring AAA Accounting	317
Configuring AAA Authorization	323
Configuring User Accounts	326
Web Authentication	328
Configuring Global Settings for Web Authentication	329
Configuring Interface Settings for Web Authentication	330
Network Access (MAC Address Authentication)	331
Configuring Global Settings for Network Access	333
Configuring Network Access for Ports	334
Configuring Port Link Detection	336
Configuring a MAC Address Filter	337
Displaying Secure MAC Address Information	339
Configuring HTTPS	341
Configuring Global Settings for HTTPS	341
Replacing the Default Secure-site Certificate	342
Configuring the Secure Shell	344
Configuring the SSH Server	347
Generating the Host Key Pair	348
Importing User Public Keys	350
Access Control Lists	352
Setting a Time Range	353
Showing TCAM Utilization	356
Setting the ACL Name and Type	357
Configuring a Standard IPv4 ACL	359
Configuring an Extended IPv4 ACL	360
Configuring a Standard IPv6 ACL	363
Configuring an Extended IPv6 ACL	365
Configuring a MAC ACL	367
Configuring an ARP ACL	369
Binding a Port to an Access Control List	371
Configuring ACL Mirroring	372
Showing ACL Hardware Counters	374

ARP Inspection	375
Configuring Global Settings for ARP Inspection	376
Configuring VLAN Settings for ARP Inspection	378
Configuring Interface Settings for ARP Inspection	380
Displaying ARP Inspection Statistics	381
Displaying the ARP Inspection Log	382
Filtering IP Addresses for Management Access	383
Configuring Port Security	385
Configuring 802.1X Port Authentication	387
Configuring 802.1X Global Settings	389
Configuring Port Authenticator Settings for 802.1X	390
Configuring Port Supplicant Settings for 802.1X	394
Displaying 802.1X Statistics	396
DoS Protection	399
IPv4 Source Guard	401
Configuring Ports for IPv4 Source Guard	401
Configuring Static Bindings for IPv4 Source Guard	403
Displaying Information for Dynamic IPv4 Source Guard Bindings	405
IPv6 Source Guard	406
Configuring Ports for IPv6 Source Guard	406
Configuring Static Bindings for IPv6 Source Guard	409
Displaying Information for Dynamic IPv6 Source Guard Bindings	411
DHCP Snooping	412
DHCP Snooping Global Configuration	415
DHCP Snooping VLAN Configuration	416
Configuring Ports for DHCP Snooping	417
Displaying DHCP Snooping Binding Information	418
14 BASIC ADMINISTRATION PROTOCOLS	421
Configuring Event Logging	422
System Log Configuration	422
Remote Log Configuration	424
Sending Simple Mail Transfer Protocol Alerts	425
Link Layer Discovery Protocol	427
Setting LLDP Timing Attributes	427
Configuring LLDP Interface Attributes	429
Configuring LLDP Interface Civic-Address	433

Displaying LLDP Local Device Information	435
Displaying LLDP Remote Device Information	438
Displaying Device Statistics	446
Power over Ethernet	448
Setting the Switch's Overall PoE Power Budget	449
Setting the Port PoE Power Budget	450
Simple Network Management Protocol	452
Configuring Global Settings for SNMP	454
Setting the Local Engine ID	456
Specifying a Remote Engine ID	457
Setting SNMPv3 Views	458
Configuring SNMPv3 Groups	461
Setting Community Access Strings	466
Configuring Local SNMPv3 Users	467
Configuring Remote SNMPv3 Users	469
Specifying Trap Managers	472
Creating SNMP Notification Logs	476
Showing SNMP Statistics	478
Remote Monitoring	480
Configuring RMON Alarms	481
Configuring RMON Events	483
Configuring RMON History Samples	485
Configuring RMON Statistical Samples	488
Switch Clustering	490
Configuring General Settings for Clusters	491
Cluster Member Configuration	492
Managing Cluster Members	494
Ethernet Ring Protection Switching	495
ERPS Global Configuration	499
ERPS Ring Configuration	500
ERPS Forced and Manual Mode Operations	516
Connectivity Fault Management	520
Configuring Global Settings for CFM	523
Configuring Interfaces for CFM	527
Configuring CFM Maintenance Domains	527
Configuring CFM Maintenance Associations	532

Configuring Maintenance End Points	537
Configuring Remote Maintenance End Points	538
Transmitting Link Trace Messages	540
Transmitting Loop Back Messages	542
Transmitting Delay-Measure Requests	544
Displaying Local MEPs	546
Displaying Details for Local MEPs	547
Displaying Local MIPs	548
Displaying Remote MEPs	549
Displaying Details for Remote MEPs	550
Displaying the Link Trace Cache	552
Displaying Fault Notification Settings	554
Displaying Continuity Check Errors	555
OAM Configuration	556
Enabling OAM on Local Ports	556
Displaying Statistics for OAM Messages	559
Displaying the OAM Event Log	560
Displaying the Status of Remote Interfaces	561
Configuring a Remote Loop Back Test	562
Displaying Results of Remote Loop Back Testing	564
15 MULTICAST FILTERING	567
Overview	567
Layer 2 IGMP (Snooping and Query for IPv4)	568
Configuring IGMP Snooping and Query Parameters	570
Specifying Static Interfaces for a Multicast Router	574
Assigning Interfaces to Multicast Services	576
Setting IGMP Snooping Status per Interface	578
Filtering IGMP Query Packets and Multicast Data	584
Displaying Multicast Groups Discovered by IGMP Snooping	585
Displaying IGMP Snooping Statistics	586
Filtering and Throttling IGMP Groups	590
Enabling IGMP Filtering and Throttling	590
Configuring IGMP Filter Profiles	591
Configuring IGMP Filtering and Throttling for Interfaces	593
MLD Snooping (Snooping and Query for IPv6)	595
Configuring MLD Snooping and Query Parameters	595

Setting Immediate Leave Status for MLD Snooping per Interface	597
Specifying Static Interfaces for an IPv6 Multicast Router	598
Assigning Interfaces to IPv6 Multicast Services	600
Showing MLD Snooping Groups and Source List	602
Multicast VLAN Registration for IPv4	603
Configuring MVR Global Settings	605
Configuring MVR Domain Settings	607
Configuring MVR Group Address Profiles	608
Configuring MVR Interface Status	611
Assigning Static MVR Multicast Groups to Interfaces	614
Displaying MVR Receiver Groups	616
Displaying MVR Statistics	617
Multicast VLAN Registration for IPv6	621
Configuring MVR6 Global Settings	622
Configuring MVR6 Domain Settings	624
Configuring MVR6 Group Address Profiles	625
Configuring MVR6 Interface Status	628
Assigning Static MVR6 Multicast Groups to Interfaces	630
Displaying MVR6 Receiver Groups	632
Displaying MVR6 Statistics	633
16 IP CONFIGURATION	639
Setting the Switch's IP Address (IP Version 4)	639
Setting the Switch's IP Address (IP Version 6)	643
Configuring the IPv6 Default Gateway	643
Configuring IPv6 Interface Settings	644
Configuring an IPv6 Address	650
Showing IPv6 Addresses	652
Showing the IPv6 Neighbor Cache	654
Showing IPv6 Statistics	655
Showing the MTU for Responding Destinations	661
17 IP SERVICES	663
Domain Name Service	663
Configuring General DNS Service Parameters	663
Configuring a List of Domain Names	664
Configuring a List of Name Servers	666
Configuring Static DNS Host to Address Entries	667

Displaying the DNS Cache	668
Dynamic Host Configuration Protocol	669
Specifying a DHCP Client Identifier	669
Configuring DHCP Relay Service	671
Configuring the PPPoE Intermediate Agent	672
Configuring PPPoE IA Global Settings	672
Configuring PPPoE IA Interface Settings	674
Showing PPPoE IA Statistics	676
18 GENERAL IP ROUTING	679
Overview	679
Initial Configuration	679
IP Routing and Switching	680
Routing Path Management	681
Routing Protocols	682
Configuring IP Routing Interfaces	682
Configuring Local and Remote Interfaces	682
Using the Ping Function	683
Using the Trace Route Function	684
Address Resolution Protocol	686
Proxy ARP Configuration	686
Configuring Static ARP Addresses	688
Displaying Dynamic or Local ARP Entries	689
Displaying ARP Statistics	690
Configuring Static Routes	691
Displaying the Routing Table	693
SECTION III	COMMAND LINE INTERFACE
	695
19 USING THE COMMAND LINE INTERFACE	697
Accessing the CLI	697
Console Connection	697
Telnet Connection	698
Entering Commands	699
Keywords and Arguments	699
Minimum Abbreviation	699
Command Completion	699

Getting Help on Commands	700
Partial Keyword Lookup	702
Negating the Effect of Commands	702
Using Command History	702
Understanding Command Modes	702
Exec Commands	703
Configuration Commands	703
Command Line Processing	705
Output Modifiers	706
CLI Command Groups	706
20 GENERAL COMMANDS	709
prompt	709
reload (Global Configuration)	710
enable	711
quit	712
show history	712
configure	713
disable	714
reload (Privileged Exec)	714
show reload	715
end	715
exit	715
21 SYSTEM MANAGEMENT COMMANDS	717
Device Designation	717
hostname	718
Banner Information	718
banner configure	719
banner configure company	720
banner configure dc-power-info	721
banner configure department	721
banner configure equipment-info	722
banner configure equipment-location	723
banner configure ip-lan	723
banner configure lp-number	724
banner configure manager-info	725
banner configure mux	725

banner configure note	726
show banner	727
System Status	727
show access-list tcam-utilization	728
show memory	728
show process cpu	729
show running-config	729
show startup-config	731
show system	732
show tech-support	732
show users	733
show version	734
show watchdog	734
watchdog software	735
Frame Size	735
jumbo frame	735
File Management	736
General Commands	737
boot system	737
copy	738
delete	741
dir	742
whichboot	743
Automatic Code Upgrade Commands	743
upgrade opcode auto	743
upgrade opcode path	744
upgrade opcode reload	745
show upgrade	746
TFTP Configuration Commands	746
ip tftp retry	746
ip tftp timeout	747
show ip tftp	747
Line	748
line	749
databits	749
exec-timeout	750

login	751
parity	752
password	752
password-thresh	753
silent-time	754
speed	754
stopbits	755
timeout login response	756
disconnect	756
terminal	757
show line	758
Event Logging	759
logging facility	759
logging history	760
logging host	761
logging on	761
logging trap	762
clear log	763
show log	763
show logging	764
SMTP Alerts	766
logging sendmail	766
logging sendmail host	766
logging sendmail level	767
logging sendmail destination-email	768
logging sendmail source-email	768
show logging sendmail	769
Time	769
SNTP Commands	770
sntp client	770
sntp poll	771
sntp server	772
show sntp	772
NTP Commands	773
ntp authenticate	773
ntp authentication-key	774

ntp client	774
ntp server	775
show ntp	776
Manual Configuration Commands	777
clock summer-time (date)	777
clock summer-time (predefined)	778
clock summer-time (recurring)	779
clock timezone	780
calendar set	781
show calendar	782
Time Range	782
time-range	783
absolute	783
periodic	784
show time-range	785
Switch Clustering	786
cluster	787
cluster commander	787
cluster ip-pool	788
cluster member	789
rcommand	789
show cluster	790
show cluster members	790
show cluster candidates	791
22 SNMP COMMANDS	793
General SNMP Commands	795
snmp-server	795
snmp-server community	795
snmp-server contact	796
snmp-server location	796
show snmp	797
SNMP Target Host Commands	798
snmp-server enable traps	798
snmp-server host	799
snmp-server enable port-traps mac-notification	801
show snmp-server enable port-traps	802

SNMPv3 Commands	803
snmp-server engine-id	803
snmp-server group	804
snmp-server user	805
snmp-server view	806
show snmp engine-id	807
show snmp group	808
show snmp user	809
show snmp view	810
Notification Log Commands	810
nlm	810
snmp-server notify-filter	811
show nlm oper-status	812
show snmp notify-filter	813
Additional Trap Commands	813
memory	813
process cpu	814
23 REMOTE MONITORING COMMANDS	815
rmon alarm	816
rmon event	817
rmon collection history	818
rmon collection rmon1	819
show rmon alarms	820
show rmon events	820
show rmon history	820
show rmon statistics	821
24 AUTHENTICATION COMMANDS	823
User Accounts and Privilege Levels	824
enable password	824
username	825
privilege	827
show privilege	827
Authentication Sequence	828
authentication enable	828
authentication login	829

RADIUS Client	830
radius-server acct-port	830
radius-server auth-port	831
radius-server host	831
radius-server key	832
radius-server retransmit	833
radius-server timeout	833
show radius-server	834
TACACS+ Client	834
tacacs-server host	835
tacacs-server key	835
tacacs-server port	836
tacacs-server retransmit	836
tacacs-server timeout	837
show tacacs-server	837
AAA	838
aaa accounting commands	838
aaa accounting dot1x	839
aaa accounting exec	840
aaa accounting update	841
aaa authorization exec	842
aaa group server	843
server	843
accounting dot1x	844
accounting commands	844
accounting exec	845
authorization exec	845
show accounting	846
Web Server	847
ip http port	847
ip http server	848
ip http secure-port	848
ip http secure-server	849
Telnet Server	850
ip telnet max-sessions	851
ip telnet port	851

ip telnet server	852
show ip telnet	852
Secure Shell	853
ip ssh authentication-retries	856
ip ssh server	856
ip ssh server-key size	857
ip ssh timeout	857
delete public-key	858
ip ssh crypto host-key generate	858
ip ssh crypto zeroize	859
ip ssh save host-key	860
show ip ssh	860
show public-key	861
show ssh	862
802.1X Port Authentication	862
General Commands	863
dot1x default	863
dot1x eapol-pass-through	864
dot1x system-auth-control	865
Authenticator Commands	865
dot1x intrusion-action	865
dot1x max-reauth-req	866
dot1x max-req	866
dot1x operation-mode	867
dot1x port-control	868
dot1x re-authentication	868
dot1x timeout quiet-period	869
dot1x timeout re-authperiod	869
dot1x timeout supp-timeout	870
dot1x timeout tx-period	870
dot1x re-authenticate	871
Supplicant Commands	872
dot1x identity profile	872
dot1x max-start	872
dot1x pae supplicant	873
dot1x timeout auth-period	874

dot1x timeout held-period	874
dot1x timeout start-period	875
Information Display Commands	875
show dot1x	875
Management IP Filter	878
management	878
show management	879
PPPoE Intermediate Agent	880
pppoe intermediate-agent	881
pppoe intermediate-agent format-type	881
pppoe intermediate-agent port-enable	882
pppoe intermediate-agent port-format-type	883
pppoe intermediate-agent trust	884
pppoe intermediate-agent vendor-tag strip	884
clear pppoe intermediate-agent statistics	885
show pppoe intermediate-agent info	885
show pppoe intermediate-agent statistics	886
25 GENERAL SECURITY MEASURES	889
Port Security	890
mac-learning	890
port security	891
port security mac-address-as-permanent	893
show port security	893
Network Access (MAC Address Authentication)	895
network-access aging	896
network-access mac-filter	897
mac-authentication reauth-time	898
network-access dynamic-qos	898
network-access dynamic-vlan	899
network-access guest-vlan	900
network-access link-detection	901
network-access link-detection link-down	901
network-access link-detection link-up	902
network-access link-detection link-up-down	902
network-access max-mac-count	903
network-access mode mac-authentication	904

network-access port-mac-filter	905
mac-authentication intrusion-action	905
mac-authentication max-mac-count	906
clear network-access	906
show network-access	907
show network-access mac-address-table	908
show network-access mac-filter	909
Web Authentication	909
web-auth login-attempts	910
web-auth quiet-period	911
web-auth session-timeout	911
web-auth system-auth-control	912
web-auth	912
web-auth re-authenticate (Port)	913
web-auth re-authenticate (IP)	913
show web-auth	914
show web-auth interface	914
show web-auth summary	915
DHCPv4 Snooping	915
ip dhcp snooping	916
ip dhcp snooping information option	918
ip dhcp snooping information policy	919
ip dhcp snooping limit rate	920
ip dhcp snooping verify mac-address	920
ip dhcp snooping vlan	921
ip dhcp snooping information option circuit-id	922
ip dhcp snooping trust	923
clear ip dhcp snooping binding	924
clear ip dhcp snooping database flash	924
ip dhcp snooping database flash	925
show ip dhcp snooping	925
show ip dhcp snooping binding	926
DHCPv6 Snooping	926
ipv6 dhcp snooping	927
ipv6 dhcp snooping option remote-id	929
ipv6 dhcp snooping option remote-id policy	930

ipv6 dhcp snooping vlan	931
ipv6 dhcp snooping max-binding	932
ipv6 dhcp snooping trust	932
clear ipv6 dhcp snooping binding	933
clear ipv6 dhcp snooping database flash	934
show ipv6 dhcp snooping	934
show ipv6 dhcp snooping binding	935
show ipv6 dhcp snooping statistics	935
IPv4 Source Guard	936
ip source-guard binding	936
ip source-guard	938
ip source-guard max-binding	939
ip source-guard mode	940
clear ip source-guard binding blocked	941
show ip source-guard	941
show ip source-guard binding	942
IPv6 Source Guard	943
ipv6 source-guard binding	943
ipv6 source-guard	945
ipv6 source-guard max-binding	946
show ipv6 source-guard	947
show ipv6 source-guard binding	948
ARP Inspection	948
ip arp inspection	949
ip arp inspection filter	950
ip arp inspection log-buffer logs	951
ip arp inspection validate	952
ip arp inspection vlan	953
ip arp inspection limit	954
ip arp inspection trust	954
show ip arp inspection configuration	955
show ip arp inspection interface	955
show ip arp inspection log	956
show ip arp inspection statistics	956
show ip arp inspection vlan	956

Denial of Service Protection	957
dos-protection echo-charge	958
dos-protection smurf	958
dos-protection tcp-flooding	959
dos-protection tcp-null-scan	959
dos-protection tcp-syn-fin-scan	960
dos-protection tcp-udp-port-zero	960
dos-protection tcp-xmas-scan	961
dos-protection udp-flooding	961
dos-protection win-nuke	962
show dos-protection	962
Port-based Traffic Segmentation	963
traffic-segmentation	963
traffic-segmentation session	964
traffic-segmentation uplink/downlink	965
traffic-segmentation uplink-to-uplink	966
show traffic-segmentation	967
26 ACCESS CONTROL LISTS	969
IPv4 ACLs	969
access-list ip	970
permit, deny (Standard IP ACL)	971
permit, deny (Extended IPv4 ACL)	972
ip access-group	975
show ip access-group	975
show ip access-list	976
IPv6 ACLs	976
access-list ipv6	977
permit, deny (Standard IPv6 ACL)	978
permit, deny (Extended IPv6 ACL)	979
ipv6 access-group	981
show ipv6 access-group	981
show ipv6 access-list	982
MAC ACLs	983
access-list mac	983
permit, deny (MAC ACL)	984
mac access-group	987

show mac access-group	988
show mac access-list	988
ARP ACLs	989
access-list arp	989
permit, deny (ARP ACL)	990
show access-list arp	991
ACL Information	992
clear access-list hardware counters	992
show access-group	992
show access-list	993
27 INTERFACE COMMANDS	995
Interface Configuration	996
interface	996
alias	997
capabilities	997
description	998
discard	999
flowcontrol	1000
media-type	1001
negotiation	1001
shutdown	1002
speed-duplex	1002
clear counters	1004
show discard	1004
show interfaces brief	1005
show interfaces counters	1005
show interfaces status	1007
show interfaces switchport	1008
Transceiver Threshold Configuration	1009
transceiver-monitor	1009
transceiver-threshold-auto	1010
transceiver-threshold current	1010
transceiver-threshold rx-power	1011
transceiver-threshold temperature	1012
transceiver-threshold tx-power	1013
transceiver-threshold voltage	1014

show interfaces transceiver	1015
show interfaces transceiver-threshold	1016
Cable Diagnostics	1017
test cable-diagnostics	1017
show cable-diagnostics	1018
Power Savings	1019
power-save	1019
show power-save	1020
28 LINK AGGREGATION COMMANDS	1021
Manual Configuration Commands	1022
port channel load-balance	1022
channel-group	1024
Dynamic Configuration Commands	1024
lacp	1024
lacp admin-key (Ethernet Interface)	1026
lacp port-priority	1027
lacp system-priority	1028
lacp admin-key (Port Channel)	1028
lacp timeout	1029
Trunk Status Display Commands	1030
show lacp	1030
show port-channel load-balance	1033
29 POWER OVER ETHERNET COMMANDS	1035
power inline compatible	1035
power mainpower maximum allocation	1036
power inline	1037
power inline maximum allocation	1038
power inline priority	1039
power inline time-range	1040
show power inline status	1041
show power inline time-range	1042
show power mainpower	1042
30 PORT MIRRORING COMMANDS	1045
Local Port Mirroring Commands	1045
port monitor	1045
show port monitor	1047

RSPAN Mirroring Commands	1048
rspan source	1050
rspan destination	1051
rspan remote vlan	1052
no rspan session	1053
show rspan	1053
31 CONGESTION CONTROL COMMANDS	1055
Rate Limit Commands	1055
rate-limit	1056
Storm Control Commands	1057
switchport packet-rate	1057
Automatic Traffic Control Commands	1058
Threshold Commands	1061
auto-traffic-control apply-timer	1061
auto-traffic-control release-timer	1062
auto-traffic-control	1063
auto-traffic-control action	1063
auto-traffic-control alarm-clear-threshold	1064
auto-traffic-control alarm-fire-threshold	1065
auto-traffic-control auto-control-release	1066
auto-traffic-control control-release	1067
SNMP Trap Commands	1067
snmp-server enable port-traps atc broadcast-alarm-clear	1067
snmp-server enable port-traps atc broadcast-alarm-fire	1068
snmp-server enable port-traps atc broadcast-control-apply	1068
snmp-server enable port-traps atc broadcast-control-release	1069
snmp-server enable port-traps atc multicast-alarm-clear	1069
snmp-server enable port-traps atc multicast-alarm-fire	1070
snmp-server enable port-traps atc multicast-control-apply	1070
snmp-server enable port-traps atc multicast-control-release	1071
ATC Display Commands	1071
show auto-traffic-control	1071
show auto-traffic-control interface	1072
32 LOOPBACK DETECTION COMMANDS	1073
loopback-detection	1074
loopback-detection action	1074

loopback-detection recover-time	1075
loopback-detection transmit-interval	1076
loopback detection trap	1076
loopback-detection release	1077
show loopback-detection	1077
33 UNIDIRECTIONAL LINK DETECTION COMMANDS	1079
udld message-interval	1079
udld aggressive	1080
udld port	1081
show udld	1082
34 ADDRESS TABLE COMMANDS	1085
mac-address-table aging-time	1085
mac-address-table static	1086
clear mac-address-table dynamic	1087
show mac-address-table	1087
show mac-address-table aging-time	1088
show mac-address-table count	1089
35 SPANNING TREE COMMANDS	1091
spanning-tree	1092
spanning-tree cisco-prestandard	1093
spanning-tree forward-time	1093
spanning-tree hello-time	1094
spanning-tree max-age	1095
spanning-tree mode	1095
spanning-tree pathcost method	1097
spanning-tree priority	1097
spanning-tree mst configuration	1098
spanning-tree system-bpdu-flooding	1099
spanning-tree transmission-limit	1099
max-hops	1100
mst priority	1100
mst vlan	1101
name	1102
revision	1102
spanning-tree bpdu-filter	1103
spanning-tree bpdu-guard	1104

spanning-tree cost	1105
spanning-tree edge-port	1106
spanning-tree link-type	1107
spanning-tree loopback-detection	1107
spanning-tree loopback-detection action	1108
spanning-tree loopback-detection release-mode	1109
spanning-tree loopback-detection trap	1110
spanning-tree mst cost	1110
spanning-tree mst port-priority	1111
spanning-tree port-bpdu-flooding	1112
spanning-tree port-priority	1112
spanning-tree root-guard	1113
spanning-tree spanning-disabled	1114
spanning-tree tc-prop-stop	1114
spanning-tree loopback-detection release	1115
spanning-tree protocol-migration	1115
show spanning-tree	1116
show spanning-tree mst configuration	1118
36 ERPS COMMANDS	1119
erps	1121
erps domain	1121
control-vlan	1122
enable	1123
guard-timer	1124
holdoff-timer	1124
major-domain	1125
meg-level	1126
mep-monitor	1126
node-id	1127
non-erps-dev-protect	1128
non-revertive	1129
propagate-tc	1133
raps-def-mac	1134
raps-without-vc	1134
ring-port	1136
rpl neighbor	1137

rpl owner	1138
version	1138
wtr-timer	1139
clear erps statistics	1140
erps clear	1140
erps forced-switch	1141
erps manual-switch	1143
show erps	1145
37 VLAN COMMANDS	1149
GVRP and Bridge Extension Commands	1150
bridge-ext gvrp	1150
garp timer	1151
switchport forbidden vlan	1152
switchport gvrp	1152
show bridge-ext	1153
show garp timer	1153
show gvrp configuration	1154
Editing VLAN Groups	1155
vlan database	1155
vlan	1156
Configuring VLAN Interfaces	1157
interface vlan	1157
switchport acceptable-frame-types	1158
switchport allowed vlan	1159
switchport ingress-filtering	1160
switchport mode	1161
switchport native vlan	1161
vlan-trunking	1162
Displaying VLAN Information	1164
show vlan	1164
Configuring IEEE 802.1Q Tunneling	1165
dot1q-tunnel system-tunnel-control	1166
switchport dot1q-tunnel mode	1167
switchport dot1q-tunnel service match cvid	1168
switchport dot1q-tunnel tpid	1170
show dot1q-tunnel	1171

Configuring L2CP Tunneling	1172
l2protocol-tunnel tunnel-dmac	1172
switchport l2protocol-tunnel	1175
show l2protocol-tunnel	1175
Configuring VLAN Translation	1176
switchport vlan-translation	1176
show vlan-translation	1178
Configuring Protocol-based VLANs	1178
protocol-vlan protocol-group (Configuring Groups)	1179
protocol-vlan protocol-group (Configuring Interfaces)	1180
show protocol-vlan protocol-group	1181
show interfaces protocol-vlan protocol-group	1181
Configuring IP Subnet VLANs	1182
subnet-vlan	1183
show subnet-vlan	1184
Configuring MAC Based VLANs	1184
mac-vlan	1185
show mac-vlan	1186
Configuring Voice VLANs	1186
voice vlan	1187
voice vlan aging	1188
voice vlan mac-address	1189
switchport voice vlan	1190
switchport voice vlan priority	1190
switchport voice vlan rule	1191
switchport voice vlan security	1192
show voice vlan	1192
38 CLASS OF SERVICE COMMANDS	1195
Priority Commands (Layer 2)	1195
queue mode	1196
queue weight	1197
switchport priority default	1198
show queue mode	1199
show queue weight	1199
Priority Commands (Layer 3 and 4)	1200
qos map cos-dscp	1200

qos map dscp-mutation	1202
qos map phb-queue	1203
qos map trust-mode	1204
show qos map cos-dscp	1205
show qos map dscp-mutation	1205
show qos map phb-queue	1206
show qos map trust-mode	1206
39 QUALITY OF SERVICE COMMANDS	1207
class-map	1208
description	1209
match	1210
rename	1211
policy-map	1211
class	1212
police flow	1213
police srtcm-color	1215
police trtcm-color	1217
set cos	1219
set ip dscp	1220
set phb	1221
service-policy	1222
show class-map	1223
show policy-map	1223
show policy-map interface	1224
40 MULTICAST FILTERING COMMANDS	1225
IGMP Snooping	1226
ip igmp snooping	1227
ip igmp snooping priority	1228
ip igmp snooping proxy-reporting	1228
ip igmp snooping querier	1229
ip igmp snooping router-alert-option-check	1229
ip igmp snooping router-port-expire-time	1230
ip igmp snooping tcn-flood	1231
ip igmp snooping tcn-query-solicit	1232
ip igmp snooping unregistered-data-flood	1232
ip igmp snooping unsolicited-report-interval	1233

ip igmp snooping version	1234
ip igmp snooping version-exclusive	1234
ip igmp snooping vlan general-query-suppression	1235
ip igmp snooping vlan immediate-leave	1236
ip igmp snooping vlan last-memb-query-count	1237
ip igmp snooping vlan last-memb-query-intvl	1237
ip igmp snooping vlan mrd	1238
ip igmp snooping vlan proxy-address	1239
ip igmp snooping vlan query-interval	1240
ip igmp snooping vlan query-resp-intvl	1241
ip igmp snooping vlan static	1242
clear ip igmp snooping groups dynamic	1242
clear ip igmp snooping statistics	1243
show ip igmp snooping	1243
show ip igmp snooping group	1244
show ip igmp snooping mrouter	1245
show ip igmp snooping statistics	1246
Static Multicast Routing	1249
ip igmp snooping vlan mrouter	1249
IGMP Filtering and Throttling	1250
ip igmp filter (Global Configuration)	1251
ip igmp profile	1251
permit, deny	1252
range	1252
ip igmp authentication	1253
ip igmp filter (Interface Configuration)	1255
ip igmp max-groups	1255
ip igmp max-groups action	1256
ip igmp query-drop	1257
ip multicast-data-drop	1257
show ip igmp authentication	1258
show ip igmp filter	1258
show ip igmp profile	1259
show ip igmp query-drop	1260
show ip igmp throttle interface	1260
show ip multicast-data-drop	1261

MLD Snooping	1262
ipv6 mld snooping	1263
ipv6 mld snooping querier	1263
ipv6 mld snooping query-interval	1264
ipv6 mld snooping query-max-response-time	1265
ipv6 mld snooping robustness	1265
ipv6 mld snooping router-port-expire-time	1266
ipv6 mld snooping unknown-multicast mode	1266
ipv6 mld snooping version	1267
ipv6 mld snooping vlan immediate-leave	1267
ipv6 mld snooping vlan mrouter	1268
ipv6 mld snooping vlan static	1269
clear ipv6 mld snooping groups dynamic	1269
clear ipv6 mld snooping statistics	1270
show ipv6 mld snooping	1270
show ipv6 mld snooping group	1271
show ipv6 mld snooping group source-list	1271
show ipv6 mld snooping mrouter	1272
MLD Filtering and Throttling	1272
ipv6 mld filter (Global Configuration)	1273
ipv6 mld profile	1274
permit, deny	1274
range	1275
ipv6 mld filter (Interface Configuration)	1275
ipv6 mld max-groups	1276
ipv6 mld max-groups action	1277
ipv6 mld query-drop	1277
ipv6 multicast-data-drop	1278
show ipv6 mld filter	1278
show ipv6 mld profile	1279
show ipv6 mld query-drop	1280
show ipv6 mld throttle interface	1280
MVR for IPv4	1281
mvr	1282
mvr associated-profile	1283
mvr domain	1283

mvr priority	1284
mvr profile	1284
mvr proxy-query-interval	1285
mvr proxy-switching	1286
mvr robustness-value	1287
mvr source-port-mode dynamic	1288
mvr upstream-source-ip	1288
mvr vlan	1289
mvr immediate-leave	1290
mvr type	1291
mvr vlan group	1292
clear mrv groups dynamic	1293
clear mrv statistics	1293
show mvr	1293
show mvr associated-profile	1295
show mvr interface	1295
show mvr members	1296
show mvr profile	1298
show mvr statistics	1298
MVR for IPv6	1303
mvr6 associated-profile	1304
mvr6 domain	1305
mvr6 priority	1305
mvr6 profile	1306
mvr6 proxy-query-interval	1307
mvr6 proxy-switching	1307
mvr6 robustness-value	1309
mvr6 source-port-mode dynamic	1309
mvr6 upstream-source-ip	1310
mvr6 vlan	1311
mvr6 immediate-leave	1311
mvr6 type	1312
mvr6 vlan group	1313
clear mvr6 groups dynamic	1314
clear mvr6 statistics	1315
show mvr6	1315

show mvr6 associated-profile	1316
show mvr6 interface	1317
show mvr6 members	1318
show mvr6 profile	1319
show mvr6 statistics	1320
41 LLDP COMMANDS	1323
lldp	1325
lldp holdtime-multiplier	1325
lldp med-fast-start-count	1326
lldp notification-interval	1326
lldp refresh-interval	1327
lldp reinit-delay	1327
lldp tx-delay	1328
lldp admin-status	1329
lldp basic-tlv management-ip-address	1329
lldp basic-tlv port-description	1330
lldp basic-tlv system-capabilities	1331
lldp basic-tlv system-description	1331
lldp basic-tlv system-name	1332
lldp dot1-tlv proto-ident	1332
lldp dot1-tlv proto-vid	1333
lldp dot1-tlv pvid	1333
lldp dot1-tlv vlan-name	1334
lldp dot3-tlv link-agg	1334
lldp dot3-tlv mac-phy	1335
lldp dot3-tlv max-frame	1335
lldp dot3-tlv poe	1336
lldp med-location civic-addr	1336
lldp med-notification	1338
lldp med-tlv ext-poe	1339
lldp med-tlv inventory	1339
lldp med-tlv location	1340
lldp med-tlv med-cap	1340
lldp med-tlv network-policy	1341
lldp notification	1341
show lldp config	1342

show lldp info local-device	1343
show lldp info remote-device	1344
show lldp info statistics	1346
42 CFM COMMANDS	1347
Defining CFM Structures	1350
ethernet cfm ais level	1350
ethernet cfm ais ma	1351
ethernet cfm ais period	1352
ethernet cfm ais suppress alarm	1352
ethernet cfm domain	1353
ethernet cfm enable	1355
ma index name	1356
ma index name-format	1357
ethernet cfm mep	1358
ethernet cfm port-enable	1359
clear ethernet cfm ais mpid	1359
show ethernet cfm configuration	1360
show ethernet cfm md	1362
show ethernet cfm ma	1362
show ethernet cfm maintenance-points local	1363
show ethernet cfm maintenance-points local detail mep	1364
show ethernet cfm maintenance-points remote detail	1365
Continuity Check Operations	1367
ethernet cfm cc ma interval	1367
ethernet cfm cc enable	1368
snmp-server enable traps ethernet cfm cc	1369
mep archive-hold-time	1370
clear ethernet cfm maintenance-points remote	1370
clear ethernet cfm errors	1371
show ethernet cfm errors	1372
Cross Check Operations	1373
ethernet cfm mep crosscheck start-delay	1373
snmp-server enable traps ethernet cfm crosscheck	1373
mep crosscheck mpid	1374
ethernet cfm mep crosscheck	1375
show ethernet cfm maintenance-points remote crosscheck	1376

Link Trace Operations	1376
ethernet cfm linktrace cache	1376
ethernet cfm linktrace cache hold-time	1377
ethernet cfm linktrace cache size	1378
ethernet cfm linktrace	1379
clear ethernet cfm linktrace-cache	1380
show ethernet cfm linktrace-cache	1380
Loopback Operations	1381
ethernet cfm loopback	1381
Fault Generator Operations	1382
mep fault-notify alarm-time	1382
mep fault-notify lowest-priority	1383
mep fault-notify reset-time	1385
show ethernet cfm fault-notify-generator	1385
Delay Measure Operations	1386
ethernet cfm delay-measure two-way	1386
43 OAM COMMANDS	1389
efm oam	1390
efm oam critical-link-event	1390
efm oam link-monitor frame	1391
efm oam link-monitor frame threshold	1392
efm oam link-monitor frame window	1392
efm oam mode	1393
clear efm oam counters	1394
clear efm oam event-log	1394
efm oam remote-loopback	1395
efm oam remote-loopback test	1396
show efm oam counters interface	1397
show efm oam event-log interface	1397
show efm oam remote-loopback interface	1399
show efm oam status interface	1399
show efm oam status remote interface	1400
44 DOMAIN NAME SERVICE COMMANDS	1401
ip domain-list	1401
ip domain-lookup	1402
ip domain-name	1403

ip host	1404
ip name-server	1405
ipv6 host	1406
clear dns cache	1406
clear host	1407
show dns	1407
show dns cache	1408
show hosts	1408
45 DHCP COMMANDS	1411
DHCP Client	1411
DHCP for IPv4	1412
ip dhcp client class-id	1412
ip dhcp restart client	1413
DHCP for IPv6	1414
ipv6 dhcp client rapid-commit vlan	1414
ipv6 dhcp restart client vlan	1415
show ipv6 dhcp duid	1416
show ipv6 dhcp vlan	1417
DHCP Relay	1417
ip dhcp relay server	1417
ip dhcp restart relay	1418
46 IP INTERFACE COMMANDS	1421
IPv4 Interface	1421
Basic IPv4 Configuration	1422
ip address	1422
ip default-gateway	1424
show ip interface	1425
show ip traffic	1425
traceroute	1426
ping	1427
ARP Configuration	1429
arp	1429
ip proxy-arp	1430
clear arp-cache	1430
show arp	1431

IPv6 Interface	1432
Interface Address Configuration and Utilities	1433
ipv6 default-gateway	1433
ipv6 address	1434
ipv6 address autoconfig	1435
ipv6 address eui-64	1436
ipv6 address link-local	1438
ipv6 enable	1439
ipv6 mtu	1441
show ipv6 default-gateway	1442
show ipv6 interface	1442
show ipv6 mtu	1444
show ipv6 traffic	1445
clear ipv6 traffic	1449
ping6	1449
traceroute6	1450
Neighbor Discovery	1452
ipv6 nd dad attempts	1452
ipv6 nd ns-interval	1453
ipv6 nd raguard	1454
ipv6 nd reachable-time	1455
clear ipv6 neighbors	1456
show ipv6 nd raguard	1456
show ipv6 neighbors	1457
ND Snooping	1458
ipv6 nd snooping	1459
ipv6 nd snooping auto-detect	1461
ipv6 nd snooping auto-detect retransmit count	1461
ipv6 nd snooping auto-detect retransmit interval	1462
ipv6 nd snooping prefix timeout	1463
ipv6 nd snooping max-binding	1463
ipv6 nd snooping trust	1464
clear ipv6 nd snooping binding	1464
clear ipv6 nd snooping prefix	1465
show ipv6 nd snooping	1465
show ipv6 nd snooping binding	1466

show ipv6 nd snooping prefix	1466
46 IP ROUTING COMMANDS	1467
Global Routing Configuration	1467
IPv4 Commands	1468
ip route	1468
ip sw-route	1469
show ip route	1469
show ip route database	1470
show ip route summary	1471

SECTION IV	APPENDICES	1473
A	SOFTWARE SPECIFICATIONS	1475
	Software Features	1475
	Management Features	1476
	Standards	1477
	Management Information Bases	1477
B	TROUBLESHOOTING	1479
	Problems Accessing the Management Interface	1479
	Using System Logs	1480
C	LICENSE INFORMATION	1481
	The GNU General Public License	1481
	GLOSSARY	1485
	COMMAND LIST	1493
	INDEX	1503

FIGURES

Figure 1: Home Page	104
Figure 2: Front Panel Indicators	105
Figure 3: System Information	124
Figure 4: General Switch Information	126
Figure 5: Configuring Support for Jumbo Frames	127
Figure 6: Displaying Bridge Extension Configuration	128
Figure 7: Copy Firmware	130
Figure 8: Saving the Running Configuration	131
Figure 9: Setting Start-Up Files	132
Figure 10: Displaying System Files	133
Figure 11: Configuring Automatic Code Upgrade	136
Figure 12: Manually Setting the System Clock	138
Figure 13: Setting the Polling Interval for SNTP	139
Figure 14: Configuring NTP	140
Figure 15: Specifying SNTP Time Servers	141
Figure 16: Adding an NTP Time Servers	142
Figure 17: Showing the NTP Time Server List	142
Figure 18: Adding an NTP Authentication Key	143
Figure 19: Showing the NTP Authentication Key List	143
Figure 20: Setting the Time Zone	144
Figure 21: Console Port Settings	146
Figure 22: Telnet Connection Settings	148
Figure 23: Displaying CPU Utilization	149
Figure 24: Displaying Memory Utilization	149
Figure 25: Restarting the Switch (Immediately)	152
Figure 26: Restarting the Switch (In)	152
Figure 27: Restarting the Switch (At)	153
Figure 28: Restarting the Switch (Regularly)	153
Figure 29: Configuring Connections by Port List	158
Figure 30: Configuring Connections by Port Range	159
Figure 31: Displaying Port Information	160

Figure 32: Configuring Local Port Mirroring	160
Figure 33: Configuring Local Port Mirroring	161
Figure 34: Displaying Local Port Mirror Sessions	162
Figure 35: Configuring Remote Port Mirroring	162
Figure 36: Configuring Remote Port Mirroring (Source)	165
Figure 37: Configuring Remote Port Mirroring (Intermediate)	165
Figure 38: Configuring Remote Port Mirroring (Destination)	166
Figure 39: Showing Port Statistics (Table)	169
Figure 40: Showing Port Statistics (Chart)	170
Figure 41: Displaying Transceiver Data	171
Figure 42: Configuring Transceiver Thresholds	174
Figure 43: Performing Cable Tests	175
Figure 44: Configuring Static Trunks	177
Figure 45: Creating Static Trunks	178
Figure 46: Adding Static Trunks Members	178
Figure 47: Configuring Connection Parameters for a Static Trunk	179
Figure 48: Showing Information for Static Trunks	179
Figure 49: Configuring Dynamic Trunks	179
Figure 50: Configuring the LACP Aggregator Admin Key	182
Figure 51: Enabling LACP on a Port	183
Figure 52: Configuring LACP Parameters on a Port	184
Figure 53: Showing Members of a Dynamic Trunk	184
Figure 54: Configuring Connection Settings for a Dynamic Trunk	185
Figure 55: Showing Connection Parameters for Dynamic Trunks	185
Figure 56: Displaying LACP Port Counters	186
Figure 57: Displaying LACP Port Internal Information	188
Figure 58: Displaying LACP Port Remote Information	189
Figure 59: Configuring Load Balancing	191
Figure 60: Enabling Power Savings	192
Figure 61: Enabling Traffic Segmentation	194
Figure 62: Configuring Members for Traffic Segmentation	195
Figure 63: Showing Traffic Segmentation Members	196
Figure 64: Configuring VLAN Trunking	196
Figure 65: Configuring VLAN Trunking	198
Figure 66: VLAN Compliant and VLAN Non-compliant Devices	200
Figure 67: Using GVRP	202

Figure 68: Creating Static VLANs	204
Figure 69: Modifying Settings for Static VLANs	204
Figure 70: Showing Static VLANs	204
Figure 71: Configuring Static Members by VLAN Index	207
Figure 72: Configuring Static VLAN Members by Interface	208
Figure 73: Configuring Static VLAN Members by Interface Range	208
Figure 74: Configuring Global Status of GVRP	210
Figure 75: Configuring GVRP for an Interface	211
Figure 76: Showing Dynamic VLANs Registered on the Switch	211
Figure 77: Showing the Members of a Dynamic VLAN	211
Figure 78: QinQ Operational Concept	213
Figure 79: Enabling QinQ Tunneling	217
Figure 80: Configuring CVLAN to SPVLAN Mapping Entries	218
Figure 81: Showing CVLAN to SPVLAN Mapping Entries	218
Figure 82: Adding an Interface to a QinQ Tunnel	220
Figure 83: Configuring Protocol VLANs	222
Figure 84: Displaying Protocol VLANs	222
Figure 85: Assigning Interfaces to Protocol VLANs	224
Figure 86: Showing the Interface to Protocol Group Mapping	224
Figure 87: Configuring IP Subnet VLANs	226
Figure 88: Showing IP Subnet VLANs	226
Figure 89: Configuring MAC-Based VLANs	228
Figure 90: Showing MAC-Based VLANs	228
Figure 91: Configuring VLAN Mirroring	230
Figure 92: Showing the VLANs to Mirror	230
Figure 93: Configuring MAC Address Learning	232
Figure 94: Configuring Static MAC Addresses	234
Figure 95: Displaying Static MAC Addresses	234
Figure 96: Setting the Address Aging Time	235
Figure 97: Displaying the Dynamic MAC Address Table	236
Figure 98: Clearing Entries in the Dynamic MAC Address Table	237
Figure 99: Mirroring Packets Based on the Source MAC Address	238
Figure 100: Showing the Source MAC Addresses to Mirror	238
Figure 101: STP Root Ports and Designated Ports	240
Figure 102: MSTP Region, Internal Spanning Tree, Multiple Spanning Tree	241
Figure 103: Spanning Tree – Common Internal, Common, Internal	241

Figure 104:	Configuring Port Loopback Detection	243
Figure 105:	Configuring Global Settings for STA (STP)	247
Figure 106:	Configuring Global Settings for STA (RSTP)	248
Figure 107:	Configuring Global Settings for STA (MSTP)	248
Figure 108:	Displaying Global Settings for STA	250
Figure 109:	Configuring Interface Settings for STA	254
Figure 110:	STA Port Roles	256
Figure 111:	Displaying Interface Settings for STA	256
Figure 112:	Creating an MST Instance	258
Figure 113:	Displaying MST Instances	258
Figure 114:	Modifying the Priority for an MST Instance	259
Figure 115:	Displaying Global Settings for an MST Instance	259
Figure 116:	Adding a VLAN to an MST Instance	260
Figure 117:	Displaying Members of an MST Instance	260
Figure 118:	Configuring MSTP Interface Settings	262
Figure 119:	Displaying MSTP Interface Settings	262
Figure 120:	Configuring Rate Limits	264
Figure 121:	Configuring Storm Control	266
Figure 122:	Storm Control by Limiting the Traffic Rate	266
Figure 123:	Storm Control by Shutting Down a Port	267
Figure 124:	Configuring ATC Timers	269
Figure 125:	Configuring ATC Interface Attributes	271
Figure 126:	Setting the Default Port Priority	274
Figure 127:	Setting the Queue Mode (Strict)	276
Figure 128:	Setting the Queue Mode (WRR)	276
Figure 129:	Setting the Queue Mode (Strict and WRR)	276
Figure 130:	Mapping CoS Values to Egress Queues	278
Figure 131:	Showing CoS Values to Egress Queue Mapping	279
Figure 132:	Setting the Trust Mode	281
Figure 133:	Configuring DSCP to DSCP Internal Mapping	282
Figure 134:	Showing DSCP to DSCP Internal Mapping	283
Figure 135:	Configuring CoS to DSCP Internal Mapping	284
Figure 136:	Showing CoS to DSCP Internal Mapping	285
Figure 137:	Configuring a Class Map	289
Figure 138:	Showing Class Maps	290
Figure 139:	Adding Rules to a Class Map	290

Figure 140: Showing the Rules for a Class Map	291
Figure 141: Configuring a Policy Map	298
Figure 142: Showing Policy Maps	299
Figure 143: Adding Rules to a Policy Map	300
Figure 144: Showing the Rules for a Policy Map	300
Figure 145: Attaching a Policy Map to a Port	302
Figure 146: Configuring a Voice VLAN	305
Figure 147: Configuring an OUI Telephony List	306
Figure 148: Showing an OUI Telephony List	306
Figure 149: Configuring Port Settings for a Voice VLAN	308
Figure 150: Configuring the Authentication Sequence	312
Figure 151: Authentication Server Operation	313
Figure 152: Configuring Remote Authentication Server (RADIUS)	316
Figure 153: Configuring Remote Authentication Server (TACACS+)	316
Figure 154: Configuring AAA Server Groups	317
Figure 155: Showing AAA Server Groups	317
Figure 156: Configuring Global Settings for AAA Accounting	320
Figure 157: Configuring AAA Accounting Methods	320
Figure 158: Showing AAA Accounting Methods	321
Figure 159: Configuring AAA Accounting Service for 802.1X Service	321
Figure 160: Configuring AAA Accounting Service for Exec Service	322
Figure 161: Displaying a Summary of Applied AAA Accounting Methods	322
Figure 162: Displaying Statistics for AAA Accounting Sessions	323
Figure 163: Configuring AAA Authorization Methods	324
Figure 164: Showing AAA Authorization Methods	325
Figure 165: Configuring AAA Authorization Methods for Exec Service	325
Figure 166: Displaying the Applied AAA Authorization Method	326
Figure 167: Configuring User Accounts	328
Figure 168: Showing User Accounts	328
Figure 169: Configuring Global Settings for Web Authentication	330
Figure 170: Configuring Interface Settings for Web Authentication	331
Figure 171: Configuring Global Settings for Network Access	334
Figure 172: Configuring Interface Settings for Network Access	336
Figure 173: Configuring Link Detection for Network Access	337
Figure 174: Configuring a MAC Address Filter for Network Access	338
Figure 175: Showing the MAC Address Filter Table for Network Access	339

Figure 176: Showing Addresses Authenticated for Network Access	340
Figure 177: Configuring HTTPS	342
Figure 178: Downloading the Secure-Site Certificate	344
Figure 179: Configuring the SSH Server	348
Figure 180: Generating the SSH Host Key Pair	349
Figure 181: Showing the SSH Host Key Pair	350
Figure 182: Copying the SSH User's Public Key	351
Figure 183: Showing the SSH User's Public Key	352
Figure 184: Setting the Name of a Time Range	354
Figure 185: Showing a List of Time Ranges	355
Figure 186: Add a Rule to a Time Range	355
Figure 187: Showing the Rules Configured for a Time Range	356
Figure 188: Showing TCAM Utilization	357
Figure 189: Creating an ACL	358
Figure 190: Showing a List of ACLs	359
Figure 191: Configuring a Standard IPv4 ACL	360
Figure 192: Configuring an Extended IPv4 ACL	363
Figure 193: Configuring a Standard IPv6 ACL	364
Figure 194: Configuring an Extended IPv6 ACL	366
Figure 195: Configuring a MAC ACL	369
Figure 196: Configuring a ARP ACL	371
Figure 197: Binding a Port to an ACL	372
Figure 198: Configuring ACL Mirroring	373
Figure 199: Showing the VLANs to Mirror	374
Figure 200: Showing ACL Statistics	375
Figure 201: Configuring Global Settings for ARP Inspection	378
Figure 202: Configuring VLAN Settings for ARP Inspection	379
Figure 203: Configuring Interface Settings for ARP Inspection	381
Figure 204: Displaying Statistics for ARP Inspection	382
Figure 205: Displaying the ARP Inspection Log	383
Figure 206: Creating an IP Address Filter for Management Access	384
Figure 207: Showing IP Addresses Authorized for Management Access	385
Figure 208: Configuring Port Security	387
Figure 209: Configuring Port Authentication	388
Figure 210: Configuring Global Settings for 802.1X Port Authentication	390
Figure 211: Configuring Interface Settings for 802.1X Port Authenticator	394

Figure 212:	Configuring Interface Settings for 802.1X Port Supplicant	396
Figure 213:	Showing Statistics for 802.1X Port Authenticator	398
Figure 214:	Showing Statistics for 802.1X Port Supplicant	398
Figure 215:	Protecting Against DoS Attacks	401
Figure 216:	Setting the Filter Type for IPv4 Source Guard	403
Figure 217:	Configuring Static Bindings for IPv4 Source Guard	404
Figure 218:	Displaying Static Bindings for IPv4 Source Guard	405
Figure 219:	Showing the IPv4 Source Guard Binding Table	406
Figure 220:	Setting the Filter Type for IPv6 Source Guard	408
Figure 221:	Configuring Static Bindings for IPv6 Source Guard	410
Figure 222:	Displaying Static Bindings for IPv6 Source Guard	411
Figure 223:	Showing the IPv6 Source Guard Binding Table	412
Figure 224:	Configuring Global Settings for DHCP Snooping	416
Figure 225:	Configuring DHCP Snooping on a VLAN	417
Figure 226:	Configuring the Port Mode for DHCP Snooping	418
Figure 227:	Displaying the Binding Table for DHCP Snooping	419
Figure 228:	Configuring Settings for System Memory Logs	423
Figure 229:	Showing Error Messages Logged to System Memory	424
Figure 230:	Configuring Settings for Remote Logging of Error Messages	425
Figure 231:	Configuring SMTP Alert Messages	426
Figure 232:	Configuring LLDP Timing Attributes	429
Figure 233:	Configuring LLDP Interface Attributes	433
Figure 234:	Configuring the Civic Address for an LLDP Interface	434
Figure 235:	Showing the Civic Address for an LLDP Interface	435
Figure 236:	Displaying Local Device Information for LLDP (General)	438
Figure 237:	Displaying Local Device Information for LLDP (Port)	438
Figure 238:	Displaying Local Device Information for LLDP (Port Details)	438
Figure 239:	Displaying Remote Device Information for LLDP (Port)	444
Figure 240:	Displaying Remote Device Information for LLDP (Port Details)	445
Figure 241:	Displaying Remote Device Information for LLDP (End Node)	446
Figure 242:	Displaying LLDP Device Statistics (General)	447
Figure 243:	Displaying LLDP Device Statistics (Port)	448
Figure 244:	Setting the Switch's PoE Budget	450
Figure 245:	Setting a Port's PoE Budget	452
Figure 246:	Configuring Global Settings for SNMP	455
Figure 247:	Configuring the Local Engine ID for SNMP	456

Figure 248: Configuring a Remote Engine ID for SNMP	458
Figure 249: Showing Remote Engine IDs for SNMP	458
Figure 250: Creating an SNMP View	459
Figure 251: Showing SNMP Views	460
Figure 252: Adding an OID Subtree to an SNMP View	460
Figure 253: Showing the OID Subtree Configured for SNMP Views	461
Figure 254: Creating an SNMP Group	465
Figure 255: Showing SNMP Groups	465
Figure 256: Setting Community Access Strings	466
Figure 257: Showing Community Access Strings	467
Figure 258: Configuring Local SNMPv3 Users	468
Figure 259: Showing Local SNMPv3 Users	469
Figure 260: Configuring Remote SNMPv3 Users	471
Figure 261: Showing Remote SNMPv3 Users	471
Figure 262: Configuring Trap Managers (SNMPv1)	475
Figure 263: Configuring Trap Managers (SNMPv2c)	475
Figure 264: Configuring Trap Managers (SNMPv3)	476
Figure 265: Showing Trap Managers	476
Figure 266: Creating SNMP Notification Logs	478
Figure 267: Showing SNMP Notification Logs	478
Figure 268: Showing SNMP Statistics	480
Figure 269: Configuring an RMON Alarm	482
Figure 270: Showing Configured RMON Alarms	483
Figure 271: Configuring an RMON Event	485
Figure 272: Showing Configured RMON Events	485
Figure 273: Configuring an RMON History Sample	487
Figure 274: Showing Configured RMON History Samples	487
Figure 275: Showing Collected RMON History Samples	488
Figure 276: Configuring an RMON Statistical Sample	489
Figure 277: Showing Configured RMON Statistical Samples	489
Figure 278: Showing Collected RMON Statistical Samples	490
Figure 279: Configuring a Switch Cluster	492
Figure 280: Configuring a Cluster Members	493
Figure 281: Showing Cluster Members	493
Figure 282: Showing Cluster Candidates	494
Figure 283: Managing a Cluster Member	495

Figure 284:	ERPS Ring Components	496
Figure 285:	Ring Interconnection Architecture (Multi-ring/Ladder Network)	498
Figure 286:	Setting ERPS Global Status	500
Figure 287:	Sub-ring with Virtual Channel	509
Figure 288:	Sub-ring without Virtual Channel	510
Figure 289:	Non-ERPS Device Protection	511
Figure 290:	Creating an ERPS Ring	514
Figure 291:	Creating an ERPS Ring	515
Figure 292:	Showing Configured ERPS Rings	515
Figure 293:	Blocking an ERPS Ring Port	520
Figure 294:	Single CFM Maintenance Domain	521
Figure 295:	Multiple CFM Maintenance Domains	522
Figure 296:	Configuring Global Settings for CFM	526
Figure 297:	Configuring Interfaces for CFM	527
Figure 298:	Configuring Maintenance Domains	531
Figure 299:	Showing Maintenance Domains	531
Figure 300:	Configuring Detailed Settings for Maintenance Domains	532
Figure 301:	Creating Maintenance Associations	535
Figure 302:	Showing Maintenance Associations	536
Figure 303:	Configuring Detailed Settings for Maintenance Associations	536
Figure 304:	Configuring Maintenance End Points	538
Figure 305:	Showing Maintenance End Points	538
Figure 306:	Configuring Remote Maintenance End Points	540
Figure 307:	Showing Remote Maintenance End Points	540
Figure 308:	Transmitting Link Trace Messages	542
Figure 309:	Transmitting Loopback Messages	543
Figure 310:	Transmitting Delay-Measure Messages	545
Figure 311:	Showing Information on Local MEPs	546
Figure 312:	Showing Detailed Information on Local MEPs	548
Figure 313:	Showing Information on Local MIPs	549
Figure 314:	Showing Information on Remote MEPs	550
Figure 315:	Showing Detailed Information on Remote MEPs	552
Figure 316:	Showing the Link Trace Cache	554
Figure 317:	Showing Settings for the Fault Notification Generator	555
Figure 318:	Showing Continuity Check Errors	556
Figure 319:	Enabling OAM for Local Ports	559

Figure 320: Displaying Statistics for OAM Messages	560
Figure 321: Displaying the OAM Event Log	561
Figure 322: Displaying Status of Remote Interfaces	562
Figure 323: Running a Remote Loop Back Test	564
Figure 324: Displaying the Results of Remote Loop Back Testing	565
Figure 325: Multicast Filtering Concept	568
Figure 326: Configuring General Settings for IGMP Snooping	574
Figure 327: Configuring a Static Interface for a Multicast Router	575
Figure 328: Showing Static Interfaces Attached a Multicast Router	576
Figure 329: Showing Current Interfaces Attached a Multicast Router	576
Figure 330: Assigning an Interface to a Multicast Service	577
Figure 331: Showing Static Interfaces Assigned to a Multicast Service	578
Figure 332: Configuring IGMP Snooping on a VLAN	583
Figure 333: Showing Interface Settings for IGMP Snooping	583
Figure 334: Dropping IGMP Query or Multicast Data Packets	584
Figure 335: Showing Multicast Groups Learned by IGMP Snooping	586
Figure 336: Displaying IGMP Snooping Statistics – Query	588
Figure 337: Displaying IGMP Snooping Statistics – VLAN	589
Figure 338: Displaying IGMP Snooping Statistics – Port	589
Figure 339: Enabling IGMP Filtering and Throttling	591
Figure 340: Creating an IGMP Filtering Profile	592
Figure 341: Showing the IGMP Filtering Profiles Created	592
Figure 342: Adding Multicast Groups to an IGMP Filtering Profile	593
Figure 343: Showing the Groups Assigned to an IGMP Filtering Profile	593
Figure 344: Configuring IGMP Filtering and Throttling Interface Settings	595
Figure 345: Configuring General Settings for MLD Snooping	597
Figure 346: Configuring Immediate Leave for MLD Snooping	598
Figure 347: Configuring a Static Interface for an IPv6 Multicast Router	599
Figure 348: Showing Static Interfaces Attached an IPv6 Multicast Router	599
Figure 349: Showing Current Interfaces Attached an IPv6 Multicast Router	600
Figure 350: Assigning an Interface to an IPv6 Multicast Service	601
Figure 351: Showing Static Interfaces Assigned to an IPv6 Multicast Service	601
Figure 352: Showing Current Interfaces Assigned to an IPv6 Multicast Service	602
Figure 353: Showing IPv6 Multicast Services and Corresponding Sources	603
Figure 354: MVR Concept	604
Figure 355: Configuring Global Settings for MVR	607

Figure 356:	Configuring Domain Settings for MVR	608
Figure 357:	Configuring an MVR Group Address Profile	610
Figure 358:	Displaying MVR Group Address Profiles	610
Figure 359:	Assigning an MVR Group Address Profile to a Domain	611
Figure 360:	Showing the MVR Group Address Profiles Assigned to a Domain	611
Figure 361:	Configuring Interface Settings for MVR	614
Figure 362:	Assigning Static MVR Groups to an Interface	615
Figure 363:	Showing the Static MVR Groups Assigned to a Port	616
Figure 364:	Displaying MVR Receiver Groups	617
Figure 365:	Displaying MVR Statistics – Query	619
Figure 366:	Displaying MVR Statistics – VLAN	620
Figure 367:	Displaying MVR Statistics – Port	621
Figure 368:	Configuring Global Settings for MVR6	623
Figure 369:	Configuring Domain Settings for MVR6	625
Figure 370:	Configuring an MVR6 Group Address Profile	627
Figure 371:	Displaying MVR6 Group Address Profiles	627
Figure 372:	Assigning an MVR6 Group Address Profile to a Domain	627
Figure 373:	Showing MVR6 Group Address Profiles Assigned to a Domain	628
Figure 374:	Configuring Interface Settings for MVR6	630
Figure 375:	Assigning Static MVR6 Groups to a Port	631
Figure 376:	Showing the Static MVR6 Groups Assigned to a Port	632
Figure 377:	Displaying MVR6 Receiver Groups	633
Figure 378:	Displaying MVR6 Statistics – Query	635
Figure 379:	Displaying MVR6 Statistics – VLAN	636
Figure 380:	Displaying MVR6 Statistics – Port	637
Figure 381:	Configuring a Static IPv4 Address	641
Figure 382:	Configuring a Dynamic IPv4 Address	642
Figure 383:	Showing the Configured IP Address for an Interface	643
Figure 384:	Configuring the IPv6 Default Gateway	644
Figure 385:	Configuring General Settings for an IPv6 Interface	649
Figure 386:	Configuring RA Guard for an IPv6 Interface	649
Figure 387:	Configuring an IPv6 Address	652
Figure 388:	Showing Configured IPv6 Addresses	653
Figure 389:	Showing IPv6 Neighbors	655
Figure 390:	Showing IPv6 Statistics (IPv6)	659
Figure 391:	Showing IPv6 Statistics (ICMPv6)	660

Figure 392: Showing IPv6 Statistics (UDP)	660
Figure 393: Showing Reported MTU Values	661
Figure 394: Configuring General Settings for DNS	664
Figure 395: Configuring a List of Domain Names for DNS	665
Figure 396: Showing the List of Domain Names for DNS	665
Figure 397: Configuring a List of Name Servers for DNS	666
Figure 398: Showing the List of Name Servers for DNS	667
Figure 399: Configuring Static Entries in the DNS Table	668
Figure 400: Showing Static Entries in the DNS Table	668
Figure 401: Showing Entries in the DNS Cache	669
Figure 402: Specifying a DHCP Client Identifier	671
Figure 403: Layer 2 DHCP Relay Service	671
Figure 404: Configuring DHCP Relay Service	672
Figure 405: Configuring Global Settings for PPPoE Intermediate Agent	674
Figure 406: Configuring Interface Settings for PPPoE Intermediate Agent	676
Figure 407: Showing PPPoE Intermediate Agent Statistics	677
Figure 408: Virtual Interfaces and Layer 3 Routing	680
Figure 409: Pinging a Network Device	684
Figure 410: Tracing the Route to a Network Device	685
Figure 411: Proxy ARP	687
Figure 412: Configuring Proxy ARP	687
Figure 413: Configuring Static ARP Entries	689
Figure 414: Displaying Static ARP Entries	689
Figure 415: Displaying Dynamic ARP Entries	690
Figure 416: Displaying Local ARP Entries	690
Figure 417: Displaying ARP Statistics	691
Figure 418: Configuring Static Routes	692
Figure 419: Displaying Static Routes	693
Figure 420: Displaying the Routing Table	694
Figure 421: Storm Control by Limiting the Traffic Rate	1060
Figure 422: Storm Control by Shutting Down a Port	1061
Figure 423: Non-ERPS Device Protection	1128
Figure 424: Sub-ring with Virtual Channel	1135
Figure 425: Sub-ring without Virtual Channel	1136
Figure 426: Configuring VLAN Trunking	1163
Figure 427: Mapping QinQ Service VLAN to Customer VLAN	1169

Figure 428: Configuring VLAN Translation

1177

TABLES

Table 1: Key Features	75
Table 2: System Defaults	82
Table 3: Options 60, 66 and 67 Statements	95
Table 4: Options 55 and 124 Statements	96
Table 5: Web Page Configuration Buttons	105
Table 6: Switch Main Menu	106
Table 7: Port Statistics	166
Table 8: LACP Port Counters	186
Table 9: LACP Internal Configuration Information	187
Table 10: LACP Remote Device Configuration Information	188
Table 11: Traffic Segmentation Forwarding	194
Table 12: Recommended STA Path Cost Range	251
Table 13: Default STA Path Costs	251
Table 14: IEEE 802.1p Egress Queue Priority Mapping	277
Table 15: CoS Priority Levels	277
Table 16: Mapping Internal Per-hop Behavior to Hardware Queues	278
Table 17: Default Mapping of DSCP Values to Internal PHB/Drop Values	282
Table 18: Default Mapping of CoS/CFI to Internal PHB/Drop Precedence	284
Table 19: Dynamic QoS Profiles	332
Table 20: HTTPS System Support	341
Table 21: Priority Bits Processed by Extended IPv4 ACL	361
Table 22: ARP Inspection Statistics	381
Table 23: ARP Inspection Log	382
Table 24: 802.1X Statistics	396
Table 25: Logging Levels	422
Table 26: LLDP MED Location CA Types	433
Table 27: Chassis ID Subtype	435
Table 28: System Capabilities	436
Table 29: Port ID Subtype	437
Table 30: Remote Port Auto-Negotiation Advertised Capability	440
Table 31: Maximum Number of Ports Providing Simultaneous Power	450

Table 32: PoE Shut Down Sequence	451
Table 33: SNMPv3 Security Models and Levels	453
Table 34: Supported Notification Messages	462
Table 35: ERPS Request/State Priority	517
Table 36: Remote MEP Priority Levels	529
Table 37: MEP Defect Descriptions	529
Table 38: OAM Operation State	557
Table 39: OAM Operation State	563
Table 40: Show IPv6 Neighbors - display description	654
Table 41: Show IPv6 Statistics - display description	656
Table 42: Show MTU - display description	661
Table 43: Options 60, 66 and 67 Statements	670
Table 44: Options 55 and 124 Statements	670
Table 45: Address Resolution Protocol	686
Table 46: ARP Statistics	690
Table 47: General Command Modes	702
Table 48: Configuration Command Modes	704
Table 49: Keystroke Commands	705
Table 50: Command Group Index	706
Table 51: General Commands	709
Table 52: System Management Commands	717
Table 53: Device Designation Commands	717
Table 54: Banner Commands	718
Table 55: System Status Commands	727
Table 56: Frame Size Commands	735
Table 57: Flash/File Commands	736
Table 58: File Directory Information	742
Table 59: Line Commands	748
Table 60: Event Logging Commands	759
Table 61: Logging Levels	760
Table 62: show logging flash/ram - display description	765
Table 63: show logging trap - display description	765
Table 64: Event Logging Commands	766
Table 65: Time Commands	769
Table 66: Predefined Summer-Time Parameters	779
Table 67: Time Range Commands	782

Table 68: Switch Cluster Commands	786
Table 69: SNMP Commands	793
Table 70: show snmp engine-id - display description	808
Table 71: show snmp group - display description	809
Table 72: show snmp user - display description	809
Table 73: show snmp view - display description	810
Table 74: RMON Commands	815
Table 75: Authentication Commands	823
Table 76: User Access Commands	824
Table 77: Default Login Settings	826
Table 78: Authentication Sequence Commands	828
Table 79: RADIUS Client Commands	830
Table 80: TACACS+ Client Commands	834
Table 81: AAA Commands	838
Table 82: Web Server Commands	847
Table 83: HTTPS System Support	850
Table 84: Telnet Server Commands	850
Table 85: Secure Shell Commands	853
Table 86: show ssh - display description	862
Table 87: 802.1X Port Authentication Commands	862
Table 88: Management IP Filter Commands	878
Table 89: PPPoE Intermediate Agent Commands	880
Table 90: show pppoe intermediate-agent statistics - display description	886
Table 91: General Security Commands	889
Table 92: Management IP Filter Commands	890
Table 93: show port security - display description	894
Table 94: Network Access Commands	895
Table 95: Dynamic QoS Profiles	899
Table 96: Web Authentication	909
Table 97: DHCP Snooping Commands	915
Table 98: Option 82 information	922
Table 99: DHCP Snooping Commands	926
Table 100: IPv4 Source Guard Commands	936
Table 101: IPv6 Source Guard Commands	943
Table 102: ARP Inspection Commands	948
Table 103: DoS Protection Commands	957

Table 104: Commands for Configuring Traffic Segmentation	963
Table 105: Traffic Segmentation Forwarding	964
Table 106: Access Control List Commands	969
Table 107: IPv4 ACL Commands	969
Table 108: Priority Bits Processed by Extended IPv4 ACL	974
Table 109: IPv6 ACL Commands	976
Table 110: MAC ACL Commands	983
Table 111: ARP ACL Commands	989
Table 112: ACL Information Commands	992
Table 113: Interface Commands	995
Table 114: show interfaces switchport - display description	1009
Table 115: Link Aggregation Commands	1021
Table 116: show lacp counters - display description	1031
Table 117: show lacp internal - display description	1031
Table 118: show lacp neighbors - display description	1032
Table 119: show lacp sysid - display description	1033
Table 120: PoE Commands	1035
Table 121: Maximum Number of Ports Providing Simultaneous Power	1038
Table 122: PoE Shut Down Sequence	1040
Table 123: show power inline status - display description	1041
Table 124: show power mainpower - display description	1043
Table 125: Port Mirroring Commands	1045
Table 126: Mirror Port Commands	1045
Table 127: RSPAN Commands	1048
Table 128: Congestion Control Commands	1055
Table 129: Rate Limit Commands	1055
Table 130: Rate Limit Commands	1057
Table 131: ATC Commands	1058
Table 132: Loopback Detection Commands	1073
Table 133: UniDirectional Link Detection Commands	1079
Table 134: show udid - display description	1082
Table 135: Address Table Commands	1085
Table 136: Spanning Tree Commands	1091
Table 137: Recommended STA Path Cost Range	1105
Table 138: Default STA Path Costs	1105
Table 139: ERPS Commands	1119

Table 140:	ERPS Request/State Priority	1142
Table 141:	show erps - summary display description	1145
Table 142:	show erps domain - detailed display description	1147
Table 143:	show erps statistics - detailed display description	1148
Table 144:	VLAN Commands	1149
Table 145:	GVRP and Bridge Extension Commands	1150
Table 146:	Commands for Editing VLAN Groups	1155
Table 147:	Commands for Configuring VLAN Interfaces	1157
Table 148:	Commands for Displaying VLAN Information	1164
Table 149:	802.1Q Tunneling Commands	1165
Table 150:	L2 Protocol Tunnel Commands	1172
Table 151:	VLAN Translation Commands	1176
Table 152:	Protocol-based VLAN Commands	1178
Table 153:	IP Subnet VLAN Commands	1182
Table 154:	MAC Based VLAN Commands	1184
Table 155:	Voice VLAN Commands	1186
Table 156:	Priority Commands	1195
Table 157:	Priority Commands (Layer 2)	1195
Table 158:	Priority Commands (Layer 3 and 4)	1200
Table 159:	Default Mapping of CoS/CFI to Internal PHB/Drop Precedence	1201
Table 160:	Default Mapping of DSCP Values to Internal PHB/Drop Values	1202
Table 161:	Mapping Internal Per-hop Behavior to Hardware Queues	1203
Table 162:	Quality of Service Commands	1207
Table 163:	Multicast Filtering Commands	1225
Table 164:	IGMP Snooping Commands	1226
Table 165:	show ip igmp snooping statistics input - display description	1247
Table 166:	show ip igmp snooping statistics output - display description	1247
Table 167:	show ip igmp snooping statistics vlan query - display description	1248
Table 168:	Static Multicast Interface Commands	1249
Table 169:	IGMP Filtering and Throttling Commands	1250
Table 170:	IGMP Authentication RADIUS Attribute Value Pairs	1254
Table 171:	MLD Snooping Commands	1262
Table 172:	IGMP Filtering and Throttling Commands	1272
Table 173:	Multicast VLAN Registration for IPv4 Commands	1281
Table 174:	show mvr - display description	1294
Table 175:	show mvr interface - display description	1296

Table 176:	show mvr members - display description	1297
Table 177:	show mvr statistics input - display description	1299
Table 178:	show mvr statistics output - display description	1300
Table 179:	show mvr statistics query - display description	1300
Table 180:	show mvr statistics summary interface - display description	1301
Table 181:	show mvr statistics summary interface mvr vlan - description	1302
Table 182:	Multicast VLAN Registration for IPv6 Commands	1303
Table 183:	show mvr6 - display description	1316
Table 184:	show mvr6 interface - display description	1317
Table 185:	show mvr6 members - display description	1319
Table 186:	show mvr6 statistics input - display description	1320
Table 187:	show mvr6 statistics output - display description	1321
Table 188:	show mvr6 statistics query - display description	1322
Table 189:	LLDP Commands	1323
Table 190:	LLDP MED Location CA Types	1337
Table 191:	CFM Commands	1347
Table 192:	show ethernet cfm configuration traps - display description	1361
Table 193:	show ethernet cfm maintenance-points local detail mep - display	1365
Table 194:	show ethernet cfm maintenance-points remote detail - display	1366
Table 195:	show ethernet cfm errors - display description	1372
Table 196:	show ethernet cfm linktrace-cache - display description	1380
Table 197:	Remote MEP Priority Levels	1384
Table 198:	MEP Defect Descriptions	1384
Table 199:	show fault-notify-generator - display description	1386
Table 200:	OAM Commands	1389
Table 201:	Address Table Commands	1401
Table 202:	show dns cache - display description	1408
Table 203:	show hosts - display description	1409
Table 204:	DHCP Commands	1411
Table 205:	DHCP Client Commands	1411
Table 206:	Options 60, 66 and 67 Statements	1412
Table 207:	Options 55 and 124 Statements	1413
Table 208:	DHCP Relay Commands	1417
Table 209:	IP Interface Commands	1421
Table 210:	IPv4 Interface Commands	1421
Table 211:	Basic IP Configuration Commands	1422

Table 212: Address Resolution Protocol Commands	1429
Table 213: IPv6 Configuration Commands	1432
Table 214: show ipv6 interface - display description	1443
Table 215: show ipv6 mtu - display description	1444
Table 216: show ipv6 traffic - display description	1446
Table 217: show ipv6 neighbors - display description	1457
Table 218: ND Snooping Commands	1459
Table 203: IP Routing Commands	1467
Table 204: Global Routing Configuration Commands	1467
Table 205: Troubleshooting Chart	1479

SECTION I

GETTING STARTED

This section provides an overview of the switch, and introduces some basic concepts about network switches. It also describes the basic settings required to access the management interface.

This section includes these chapters:

- ◆ ["Introduction" on page 75](#)
- ◆ ["Initial Switch Configuration" on page 85](#)

This switch provides a broad range of features for Layer 2 switching and Layer 3 static routing. It includes a management agent that allows you to configure the features listed in this manual. The default configuration can be used for most of the features provided by this switch. However, there are many options that you should configure to maximize the switch's performance for your particular network environment.

KEY FEATURES

Table 1: Key Features

Feature	Description
Configuration Backup and Restore	Using management station or FTP/TFTP server
Authentication	Console, Telnet, web – user name/password, RADIUS, TACACS+ Port – IEEE 802.1X, MAC address filtering SNMP v1/2c - Community strings SNMP version 3 – MD5 or SHA password Telnet – SSH Web – HTTPS
General Security Measures	AAA ARP Inspection DHCP Snooping (with Option 82 relay information) DoS Protection IP Source Guard PPPoE Intermediate Agent Port Authentication – IEEE 802.1X Port Security – MAC address filtering Traffic Segmentation - by port designation
Access Control Lists	Supports up to 512 rules, 64 ACLs, and a maximum of 32 rules for an ACL
DHCP/DHCPv6	Client
DNS	Client and Proxy service
Port Configuration	Speed and duplex mode and flow control
Port Trunking	Supports up to 12 trunks – static or dynamic trunking (LACP)
Port Mirroring	50 sessions, one or more source ports to one analysis port
Congestion Control	Rate Limiting Throttling for broadcast, multicast, unknown unicast storms Random Early Detection
Address Table	16K MAC addresses in the forwarding table, 1K static MAC addresses, 256 L2 multicast groups, 32 static ARP entries, 24 static IP routes, 8 IP interfaces
IP Version 4 and 6	Supports IPv4 and IPv6 addressing, and management

Table 1: Key Features (Continued)

Feature	Description
IEEE 802.1D Bridge	Supports dynamic data switching and addresses learning
Store-and-Forward Switching	Supported to ensure wire-speed switching while eliminating bad frames
Spanning Tree Algorithm	Supports standard STP, Rapid Spanning Tree Protocol (RSTP), and Multiple Spanning Trees (MSTP)
Virtual LANs	Up to 4094 using IEEE 802.1Q, port-based, protocol-based, voice VLANs, and QinQ tunnel
Traffic Prioritization	Default port priority, traffic class map, queue scheduling, IP Precedence, or Differentiated Services Code Point (DSCP)
Qualify of Service	Supports Differentiated Services (DiffServ)
Link Layer Discovery Protocol	Used to discover basic information about neighboring devices
IP Routing	Supports static routing
ARP	Static and dynamic address configuration, proxy ARP
Multicast Filtering	Supports IGMP snooping and query, and Multicast VLAN Registration
Switch Clustering	Supports up to 36 member switches in a cluster
Connectivity Fault Management	Connectivity monitoring using continuity check messages, fault verification through loop back messages, and fault isolation by examining end-to-end connections (IEEE 802.1ag)
ERPS	Supports Ethernet Ring Protection Switching for increased availability of Ethernet rings (G.8032)
Remote Device Management	Supports Ethernet OAM functions for attached CPEs (IEEE 802.3ah, ITU-T Y.1731)

DESCRIPTION OF SOFTWARE FEATURES

The switch provides a wide range of advanced performance enhancing features. Flow control eliminates the loss of packets due to bottlenecks caused by port saturation. Storm suppression prevents broadcast, multicast, and unknown unicast traffic storms from engulfing the network. Untagged (port-based), tagged, and protocol-based VLANs, plus support for automatic GVRP VLAN registration provide traffic security and efficient use of network bandwidth. CoS priority queueing ensures the minimum delay for moving real-time multimedia data across the network. While multicast filtering provides support for real-time network applications.

Some of the management features are briefly described below.

CONFIGURATION BACKUP AND RESTORE

You can save the current configuration settings to a file on the management station (using the web interface) or an FTP/TFTP server (using the web or console interface), and later download this file to restore the switch configuration settings.

AUTHENTICATION This switch authenticates management access via the console port, Telnet, or a web browser. User names and passwords can be configured locally or can be verified via a remote authentication server (i.e., RADIUS or TACACS+). Port-based authentication is also supported via the IEEE 802.1X protocol. This protocol uses Extensible Authentication Protocol over LANs (EAPOL) to request user credentials from the 802.1X client, and then uses the EAP between the switch and the authentication server to verify the client's right to access the network via an authentication server (i.e., RADIUS or TACACS+ server).

Other authentication options include HTTPS for secure management access via the web, SSH for secure management access over a Telnet-equivalent connection, SNMP Version 3, IP address filtering for SNMP/Telnet/web management access, MAC address filtering and IP source guard also provide authenticated port access. While DHCP snooping is provided to prevent malicious attacks from insecure ports. While PPPoE Intermediate Agent supports authentication of a client for a service provider.

ACCESS CONTROL LISTS ACLs provide packet filtering for IP frames (based on address, protocol, TCP/UDP port number or TCP control code) or any frames (based on MAC address or Ethernet type). ACLs can be used to improve performance by blocking unnecessary network traffic or to implement security controls by restricting access to specific network resources or protocols.

PORT CONFIGURATION You can manually configure the speed, duplex mode, and flow control used on specific ports, or use auto-negotiation to detect the connection settings used by the attached device. Use full-duplex mode on ports whenever possible to double the throughput of switch connections. Flow control should also be enabled to control network traffic during periods of congestion and prevent the loss of packets when port buffer thresholds are exceeded. The switch supports flow control based on the IEEE 802.3x standard (now incorporated in IEEE 802.3-2002).

RATE LIMITING This feature controls the maximum rate for traffic transmitted or received on an interface. Rate limiting is configured on interfaces at the edge of a network to limit traffic into or out of the network. Packets that exceed the acceptable amount of traffic are dropped.

PORT MIRRORING The switch can unobtrusively mirror traffic from any port to a monitor port. You can then attach a protocol analyzer or RMON probe to this port to perform traffic analysis and verify connection integrity.

PORT TRUNKING Ports can be combined into an aggregate connection. Trunks can be manually set up or dynamically configured using Link Aggregation Control Protocol (LACP – IEEE 802.3-2005). The additional ports dramatically increase the throughput across any connection, and provide redundancy by

taking over the load if a port in the trunk should fail. The switch supports up to 12 trunks.

STORM CONTROL Broadcast, multicast and unknown unicast storm suppression prevents traffic from overwhelming the network. When enabled on a port, the level of traffic passing through the port is restricted. If traffic rises above a pre-defined threshold, it will be throttled until the level falls back beneath the threshold.

STATIC MAC ADDRESSES A static address can be assigned to a specific interface on this switch. Static addresses are bound to the assigned interface and will not be moved. When a static address is seen on another interface, the address will be ignored and will not be written to the address table. Static addresses can be used to provide network security by restricting access for a known host to a specific port.

IP ADDRESS FILTERING Access to insecure ports can be controlled using DHCP Snooping which filters ingress traffic based on static IP addresses and addresses stored in the DHCP Snooping table. Traffic can also be restricted to specific source IP addresses or source IP/MAC address pairs based on static entries or entries stored in the DHCP Snooping table.

IEEE 802.1D BRIDGE The switch supports IEEE 802.1D transparent bridging. The address table facilitates data switching by learning addresses, and then filtering or forwarding traffic based on this information. The address table supports up to 16K addresses.

STORE-AND-FORWARD SWITCHING The switch copies each frame into its memory before forwarding them to another port. This ensures that all frames are a standard Ethernet size and have been verified for accuracy with the cyclic redundancy check (CRC). This prevents bad frames from entering the network and wasting bandwidth.

To avoid dropping frames on congested ports, the switch provides 8 Mbits for frame buffering. This buffer can queue packets awaiting transmission on congested networks.

SPANNING TREE ALGORITHM The switch supports these spanning tree protocols:

- ◆ Spanning Tree Protocol (STP, IEEE 802.1D) – This protocol provides loop detection. When there are multiple physical paths between segments, this protocol will choose a single path and disable all others to ensure that only one route exists between any two stations on the network. This prevents the creation of network loops. However, if the chosen path should fail for any reason, an alternate path will be activated to maintain the connection.

- ◆ Rapid Spanning Tree Protocol (RSTP, IEEE 802.1w) – This protocol reduces the convergence time for network topology changes to about 3 to 5 seconds, compared to 30 seconds or more for the older IEEE 802.1D STP standard. It is intended as a complete replacement for STP, but can still interoperate with switches running the older standard by automatically reconfiguring ports to STP-compliant mode if they detect STP protocol messages from attached devices.
- ◆ Multiple Spanning Tree Protocol (MSTP, IEEE 802.1s) – This protocol is a direct extension of RSTP. It can provide an independent spanning tree for different VLANs. It simplifies network management, provides for even faster convergence than RSTP by limiting the size of each region, and prevents VLAN members from being segmented from the rest of the group (as sometimes occurs with IEEE 802.1D STP).

CONNECTIVITY FAULT MANAGEMENT

The switch provides connectivity fault monitoring for end-to-end connections within a designated service area by using continuity check messages which can detect faults in maintenance points, fault verification through loop back messages, and fault isolation with link trace messages.

VIRTUAL LANS

The switch supports up to 4094 VLANs. A Virtual LAN is a collection of network nodes that share the same collision domain regardless of their physical location or connection point in the network. The switch supports tagged VLANs based on the IEEE 802.1Q standard. Members of VLAN groups can be dynamically learned via GVRP, or ports can be manually assigned to a specific set of VLANs. This allows the switch to restrict traffic to the VLAN groups to which a user has been assigned. By segmenting your network into VLANs, you can:

- ◆ Eliminate broadcast storms which severely degrade performance in a flat network.
- ◆ Simplify network management for node changes/moves by remotely configuring VLAN membership for any port, rather than having to manually change the network connection.
- ◆ Provide data security by restricting all traffic to the originating VLAN, except where a connection is explicitly defined via the switch's routing service.
- ◆ Use private VLANs to restrict traffic to pass only between data ports and the uplink ports, thereby isolating adjacent ports within the same VLAN, and allowing you to limit the total number of VLANs that need to be configured.
- ◆ Use protocol VLANs to restrict traffic to specified interfaces based on protocol type.

IEEE 802.1Q TUNNELING (QINQ) This feature is designed for service providers carrying traffic for multiple customers across their networks. QinQ tunneling is used to maintain customer-specific VLAN and Layer 2 protocol configurations even when different customers use the same internal VLAN IDs. This is accomplished by inserting Service Provider VLAN (SPVLAN) tags into the customer's frames when they enter the service provider's network, and then stripping the tags when the frames leave the network.

TRAFFIC PRIORITIZATION This switch prioritizes each packet based on the required level of service, using four priority queues with strict priority, Weighted Round Robin (WRR) scheduling, or a combination of strict and weighted queuing. It uses IEEE 802.1p and 802.1Q tags to prioritize incoming traffic based on input from the end-station application. These functions can be used to provide independent priorities for delay-sensitive data and best-effort data.

This switch also supports several common methods of prioritizing layer 3/4 traffic to meet application requirements. Traffic can be prioritized based on the priority bits in the IP frame's Type of Service (ToS) octet using DSCP, or IP Precedence. When these services are enabled, the priorities are mapped to a Class of Service value by the switch, and the traffic then sent to the corresponding output queue.

IP ROUTING The switch provides Layer 3 IP static routing. To maintain a high rate of throughput, the switch forwards all traffic passing within the same segment, and routes only traffic that passes between different subnetworks. The wire-speed routing provided by this switch lets you easily link network segments or VLANs together without having to deal with the bottlenecks or configuration hassles normally associated with conventional routers.

Static Routing – Traffic is automatically routed between any IP interfaces configured on the switch. Routing to statically configured hosts or subnet addresses is provided based on next-hop entries specified in the static routing table.

ADDRESS RESOLUTION PROTOCOL The switch uses ARP and Proxy ARP to convert between IP addresses and MAC (hardware) addresses. This switch supports conventional ARP, which locates the MAC address corresponding to a given IP address. This allows the switch to use IP addresses for routing decisions and the corresponding MAC addresses to forward packets from one hop to the next. Either static or dynamic entries can be configured in the ARP cache.

Proxy ARP allows hosts that do not support routing to determine the MAC address of a device on another network or subnet. When a host sends an ARP request for a remote network, the switch checks to see if it has the best route. If it does, it sends its own MAC address to the host. The host then sends traffic for the remote destination via the switch, which uses its own routing table to reach the destination on the other network.

QUALITY OF SERVICE Differentiated Services (DiffServ) provides policy-based management mechanisms used for prioritizing network resources to meet the requirements of specific traffic types on a per-hop basis. Each packet is classified upon entry into the network based on access lists, IP Precedence or DSCP values, or VLAN lists. Using access lists allows you select traffic based on Layer 2, Layer 3, or Layer 4 information contained in each packet. Based on network policies, different kinds of traffic can be marked for different kinds of forwarding.

ETHERNET RING PROTECTION SWITCHING ERPS can be used to increase the availability and robustness of Ethernet rings, such as those used in Metropolitan Area Networks (MAN). ERPS provides Layer 2 loop avoidance and fast reconvergence in Layer 2 ring topologies, supporting up to 255 nodes in the ring structure. It can also function with IEEE 802.1ag to support link monitoring when non-participating devices exist within the Ethernet ring.

OPERATION, ADMINISTRATION, AND MAINTENANCE The switch provides OAM remote management tools required to monitor and maintain the links to subscriber CPEs (Customer Premise Equipment). This section describes functions including enabling OAM for selected ports, loopback testing, and displaying remote device information.

MULTICAST FILTERING Specific multicast traffic can be assigned to its own VLAN to ensure that it does not interfere with normal network traffic and to guarantee real-time delivery by setting the required priority level for the designated VLAN. The switch uses IGMP Snooping and Query to manage multicast group registration. It also supports Multicast VLAN Registration (MVR for IPv4 and MVR6 for IPv6) which allows common multicast traffic, such as television channels, to be transmitted across a single network-wide multicast VLAN shared by hosts residing in other standard or private VLAN groups, while preserving security and data isolation for normal traffic.

LINK LAYER DISCOVERY PROTOCOL LLDP is used to discover basic information about neighboring devices within the local broadcast domain. LLDP is a Layer 2 protocol that advertises information about the sending device and collects information gathered from neighboring network nodes it discovers.

Advertised information is represented in Type Length Value (TLV) format according to the IEEE 802.1ab standard, and can include details such as device identification, capabilities and configuration settings. Media Endpoint Discovery (LLDP-MED) is an extension of LLDP intended for managing endpoint devices such as Voice over IP phones and network switches. The LLDP-MED TLVs advertise information such as network policy, power, inventory, and device location details. The LLDP and LLDP-MED information can be used by SNMP applications to simplify troubleshooting, enhance network management, and maintain an accurate network topology.

SYSTEM DEFAULTS

The switch's system defaults are provided in the configuration file "Factory_Default_Config.cfg." To reset the switch defaults, this file should be set as the startup configuration file.

The following table lists some of the basic system defaults.

Table 2: System Defaults

Function	Parameter	Default
Console Port Connection	Baud Rate	115200 bps
	Data bits	8
	Stop bits	1
	Parity	none
	Local Console Timeout	600 seconds
Authentication and Security Measures	Privileged Exec Level	Username "admin" Password "admin"
	Normal Exec Level	Username "guest" Password "guest"
	Enable Privileged Exec from Normal Exec Level	Password "super"
	RADIUS Authentication	Disabled
	TACACS+ Authentication	Disabled
	802.1X Port Authentication	Disabled
	Web Authentication	Disabled
	MAC Authentication	Disabled
	PPPoE Intermediate Agent	Disabled
	HTTPS	Enabled
	SSH	Disabled
	Port Security	Disabled
	IP Filtering	Disabled
	DHCP Snooping	Disabled
IP Source Guard	Disabled (all ports)	
Web Management	HTTP Server	Enabled
	HTTP Port Number	80
	HTTP Secure Server	Disabled
	HTTP Secure Server Port	443

Table 2: System Defaults (Continued)

Function	Parameter	Default
SNMP	SNMP Agent	Enabled
	Community Strings	"public" (read only) "private" (read/write)
	Traps	Authentication traps: enabled Link-up-down events: enabled
	SNMP V3	View: defaultview Group: public (read only); private (read/write)
Port Configuration	Admin Status	Enabled
	Auto-negotiation	Enabled
	Flow Control	Disabled
Port Trunking	Static Trunks	None
	LACP (all ports)	Disabled
Congestion Control	Rate Limiting	Disabled
	Storm Control	Broadcast: Disabled (500 packets/sec) Multicast: Disabled Unknown Unicast: Disabled
	Auto Traffic Control	Disabled
Address Table	Aging Time	300 seconds
Spanning Tree Algorithm	Status	Enabled, RSTP (Defaults: RSTP standard)
	Edge Ports	Auto
LLDP	Status	Enabled
ERPS	Status	Disabled
CFM	Status	Enabled
OAM	Status	Disabled
Virtual LANs	Default VLAN	1
	PVID	1
	Acceptable Frame Type	All
	Ingress Filtering	Disabled
	Switchport Mode (Egress Mode)	Hybrid
	GVRP (global)	Disabled
	GVRP (port interface)	Disabled
	QinQ Tunneling	Disabled

Table 2: System Defaults (Continued)

Function	Parameter	Default
Traffic Prioritization	Ingress Port Priority	0
	Queue Mode	WRR
	Queue Weight	Queue: 0 1 2 3 Weight: 1 2 4 6
	Class of Service	Enabled
	IP Precedence Priority	Disabled
	IP DSCP Priority	Disabled
IP Settings	Management. VLAN	VLAN 1
	IP Address	DHCP assigned
	Subnet Mask	255.255.255.0
	Default Gateway	not defined
	DHCP	Client: Disabled
	DNS	Proxy service: Disabled
	BOOTP	Disabled
	ARP	Enabled Cache Timeout: 20 minutes Proxy: Disabled
Multicast Filtering	IGMP Snooping (Layer 2)	Snooping: Enabled Querier: Disabled
	Multicast VLAN Registration	Disabled
	IGMP Proxy Reporting	Disabled
System Log	Status	Enabled
	Messages Logged to RAM	Levels 0-7 (all)
	Messages Logged to Flash	Levels 0-3
SMTP Email Alerts	Event Handler	Enabled (but no server defined)
SNTP	Clock Synchronization	Disabled
Switch Clustering	Status	Disabled
	Commander	Disabled

This chapter includes information on connecting to the switch and basic configuration procedures.

CONNECTING TO THE SWITCH

The switch includes a built-in network management agent. The agent offers a variety of management options, including SNMP, RMON and a web-based interface. A PC may also be connected directly to the switch for configuration and monitoring via a command line interface (CLI).



NOTE: An IPv4 address for this switch is obtained via DHCP by default. To change this address, see "[Setting an IP Address](#)" on page 89.

CONFIGURATION OPTIONS

The switch's HTTP web agent allows you to configure switch parameters, monitor port connections, and display statistics using a standard web browser such as Internet Explorer 6, Mozilla Firefox 4, or Google Chrome 29, or more recent versions. The switch's web management interface can be accessed from any computer attached to the network.

The CLI program can be accessed by a direct connection to the RS-232 serial console port on the switch, or remotely by a Telnet connection over the network.

The switch's management agent also supports SNMP (Simple Network Management Protocol). This SNMP agent permits the switch to be managed from any system in the network using network management software.

The switch's web interface, console interface, and SNMP agent allow you to perform the following management functions:

- ◆ Set user names and passwords
- ◆ Set an IP interface for any VLAN
- ◆ Configure SNMP parameters
- ◆ Enable/disable any port
- ◆ Set the speed/duplex mode for any port
- ◆ Configure the bandwidth of any port by limiting input or output rates
- ◆ Control port access through IEEE 802.1X security or static address filtering

- ◆ Filter packets using Access Control Lists (ACLs)
- ◆ Configure up to 4094 IEEE 802.1Q VLANs
- ◆ Enable GVRP automatic VLAN registration
- ◆ Configure IP routing for unicast traffic
- ◆ Configure IGMP multicast filtering
- ◆ Upload and download system firmware or configuration files via HTTP (using the web interface) or FTP/TFTP (using the command line or web interface)
- ◆ Configure Spanning Tree parameters
- ◆ Configure Class of Service (CoS) priority queuing
- ◆ Configure static or LACP trunks (up to 12)
- ◆ Enable port mirroring
- ◆ Set storm control on any port for excessive broadcast, multicast, or unknown unicast traffic
- ◆ Display system information and statistics

REQUIRED CONNECTIONS

The switch provides an RS-232 serial port that enables a connection to a PC or terminal for monitoring and configuring the switch. A null-modem console cable is provided with the switch.

Attach a VT100-compatible terminal, or a PC running a terminal emulation program to the switch. You can use the console cable provided with this package, or use a null-modem cable that complies with the wiring assignments shown in the Installation Guide.

To connect a terminal to the console port, complete the following steps:

1. Connect the console cable to the serial port on a terminal, or a PC running terminal emulation software, and tighten the captive retaining screws on the DB-9 connector.
2. Connect the other end of the cable to the RS-45 serial port on the switch.
3. Make sure the terminal emulation software is set as follows:
 - Select the appropriate serial port (COM port 1 or COM port 2).
 - Set the baud rate to 115200 bps.
 - Set the data format to 8 data bits, 1 stop bit, and no parity.
 - Set flow control to none.
 - Set the emulation mode to VT100.
 - When using HyperTerminal, select Terminal keys, not Windows keys.



NOTE: Once you have set up the terminal correctly, the console login screen will be displayed.

For a description of how to use the CLI, see ["Using the Command Line Interface" on page 697](#). For a list of all the CLI commands and detailed information on using the CLI, refer to ["CLI Command Groups" on page 706](#).

REMOTE CONNECTIONS

Prior to accessing the switch's onboard agent via a network connection, you must first configure it with a valid IP address, subnet mask, and default gateway using a console connection, or DHCP protocol.

An IPv4 address for this switch is obtained via DHCP by default. To manually configure this address or enable dynamic address assignment via DHCP, see ["Setting an IP Address" on page 89](#).



NOTE: This switch supports eight Telnet sessions or SSH sessions.

After configuring the switch's IP parameters, you can access the onboard configuration program from anywhere within the attached network. The onboard configuration program can be accessed using Telnet from any computer attached to the network. The switch can also be managed by any computer using a web browser (Internet Explorer 6, Mozilla Firefox 4, or Google Chrome 29, or more recent versions), or from a network computer using SNMP network management software.

The onboard program only provides access to basic configuration functions. To access the full range of SNMP management functions, you must use SNMP-based network management software.

BASIC CONFIGURATION

CONSOLE CONNECTION

The CLI program provides two different command levels — normal access level (Normal Exec) and privileged access level (Privileged Exec). The commands available at the Normal Exec level are a limited subset of those available at the Privileged Exec level and allow you to only display information and use basic utilities. To fully configure the switch parameters, you must access the CLI at the Privileged Exec level.

Access to both CLI levels are controlled by user names and passwords. The switch has a default user name and password for each level. To log into the

CLI at the Privileged Exec level using the default user name and password, perform these steps:

1. To initiate your console connection, press <Enter>. The "User Access Verification" procedure starts.
2. At the Username prompt, enter "admin."
3. At the Password prompt, also enter "admin." (The password characters are not displayed on the console screen.)
4. The session is opened and the CLI displays the "Console#" prompt indicating you have access at the Privileged Exec level.

SETTING PASSWORDS If this is your first time to log into the CLI program, you should define new passwords for both default user names using the "username" command, record them and put them in a safe place.

Passwords can consist of up to 32 alphanumeric characters and are case sensitive. To prevent unauthorized access to the switch, set the passwords as follows:

1. Open the console interface with the default user name and password "admin" to access the Privileged Exec level.
2. Type "configure" and press <Enter>.
3. Type "username guest password 0 *password*," for the Normal Exec level, where *password* is your new password. Press <Enter>.
4. Type "username admin password 0 *password*," for the Privileged Exec level, where *password* is your new password. Press <Enter>.

```
Username: admin
Password:

CLI session with the ECS4110-52T* is opened.
To end the CLI session, enter [Exit].

Console#configure
Console(config)#username guest password 0 [password]
Console(config)#username admin password 0 [password]
Console(config)#
```

* This manual covers the ECS4110-28T, ECS4110-28P, ECS4110-52T and ECS4110-52P Gigabit Ethernet switches. Other than the difference in port count and support for PoE (ECS4110-28P/52P), there are no other significant differences. Therefore nearly all of the screen display examples are based on the ECS4110-52T.

SETTING AN IP ADDRESS You must establish IP address information for the switch to obtain management access through the network. This can be done in either of the following ways:

- ◆ **Manual** — You have to input the information, including IP address and subnet mask. If your management station is not in the same IP subnet as the switch, you will also need to specify the default gateway router.
- ◆ **Dynamic** — The switch can send IPv4 configuration requests to BOOTP or DHCP address allocation servers on the network, or automatically generate a unique IPv6 host address based on the local subnet address prefix received in router advertisement messages. An IPv6 link local address for use in a local network can also be dynamically generated as described in ["Obtaining an IPv6 Address" on page 93](#).
- ◆ The current software supports DHCP for IPv6, so an IPv6 global unicast address for use in a network containing more than one subnet can be obtained through the DHCPv6 server, or manually configured as described in ["Assigning an IPv6 Address" on page 90](#).

MANUAL CONFIGURATION

You can manually assign an IP address to the switch. You may also need to specify a default gateway that resides between this device and management stations that exist on another network segment. Valid IPv4 addresses consist of four decimal numbers, 0 to 255, separated by periods. Anything outside this format will not be accepted by the CLI program.



NOTE: The IPv4 address for VLAN 1 is obtained via DHCP by default.

ASSIGNING AN IPv4 ADDRESS

Before you can assign an IP address to the switch, you must obtain the following information from your network administrator:

- ◆ IP address for the switch
- ◆ Network mask for this network
- ◆ Default gateway for the network

To assign an IPv4 address to the switch, complete the following steps

1. From the Global Configuration mode prompt, type "interface vlan 1" to access the interface-configuration mode. Press <Enter>.
2. Type "ip address *ip-address netmask*," where "ip-address" is the switch IP address and "netmask" is the network mask for the network. Press <Enter>.
3. Type "exit" to return to the global configuration mode prompt. Press <Enter>.

4. To set the IP address of the default gateway for the network to which the switch belongs, type "ip default-gateway *gateway*," where "gateway" is the IP address of the default gateway. Press <Enter>.

```
Console(config)#interface vlan 1
Console(config-if)#ip address 192.168.1.5 255.255.255.0
Console(config-if)#exit
Console(config)#ip default-gateway 192.168.1.254
Console(config)#
```

ASSIGNING AN IPV6 ADDRESS

This section describes how to configure a "link local" address for connectivity within the local subnet only, and also how to configure a "global unicast" address, including a network prefix for use on a multi-segment network and the host portion of the address.

An IPv6 prefix or address must be formatted according to RFC 2373 "IPv6 Addressing Architecture," using 8 colon-separated 16-bit hexadecimal values. One double colon may be used to indicate the appropriate number of zeros required to fill the undefined fields. For detailed information on the other ways to assign IPv6 addresses, see "[Setting the Switch's IP Address \(IP Version 6\)](#)" on page 643.

Link Local Address — All link-local addresses must be configured with a prefix in the range of FE80~FEBF. Remember that this address type makes the switch accessible over IPv6 for all devices attached to the same local subnet only. Also, if the switch detects that the address you configured conflicts with that in use by another device on the subnet, it will stop using the address in question, and automatically generate a link local address that does not conflict with any other devices on the local subnet.

To configure an IPv6 link local address for the switch, complete the following steps:

1. From the Global Configuration mode prompt, type "interface vlan 1" to access the interface-configuration mode. Press <Enter>.
2. Type "ipv6 address" followed by up to 8 colon-separated 16-bit hexadecimal values for the *ipv6-address* similar to that shown in the example, followed by the "link-local" command parameter. Then press <Enter>.

```
Console(config)#interface vlan 1
Console(config-if)#ipv6 address FE80::260:3EFF:FE11:6700 link-local
Console(config-if)#ipv6 enable
Console(config-if)#end
Console#show ipv6 interface
VLAN 1 is up
IPv6 is enabled.
Link-local address:
  fe80::260:3eff:fe11:6700%1/64
Global unicast address(es):
  (None)
Joined group address(es):
  ff02::1:ff11:6700
```

```

ff02::1
IPv6 link MTU is 1500 bytes
ND DAD is enabled, number of DAD attempts: 3.
ND retransmit interval is 1000 milliseconds
ND advertised retransmit interval is 0 milliseconds
ND reachable time is 30000 milliseconds
ND advertised reachable time is 0 milliseconds
ND advertised router lifetime is 1800 seconds

Console#

```

Address for Multi-segment Network — Before you can assign an IPv6 address to the switch that will be used to connect to a multi-segment network, you must obtain the following information from your network administrator:

- ◆ Prefix for this network
- ◆ IP address for the switch
- ◆ Default gateway for the network

For networks that encompass several different subnets, you must define the full address, including a network prefix and the host address for the switch. You can specify either the full IPv6 address, or the IPv6 address and prefix length. The prefix length for an IPv6 network is the number of bits (from the left) of the prefix that form the network address, and is expressed as a decimal number. For example, all IPv6 addresses that start with the first byte of 73 (hexadecimal) could be expressed as 73:0:0:0:0:0:0:0/8 or 73::/8.

To generate an IPv6 global unicast address for the switch, complete the following steps:

1. From the global configuration mode prompt, type "interface vlan 1" to access the interface-configuration mode. Press <Enter>.
2. From the interface prompt, type "ipv6 address *ipv6-address*" or "ipv6 address *ipv6-address/prefix-length*," where "prefix-length" indicates the address bits used to form the network portion of the address. (The network address starts from the left of the prefix and should encompass some of the *ipv6-address* bits.) The remaining bits are assigned to the host interface. Press <Enter>.
3. Type "exit" to return to the global configuration mode prompt. Press <Enter>.
4. To set the IP address of the IPv6 default gateway for the network to which the switch belongs, type "ipv6 default-gateway *gateway*," where "gateway" is the IPv6 address of the default gateway. Press <Enter>.

```

Console(config)#interface vlan 1
Console(config-if)#ipv6 address 2001:DB8:2222:7272::66/64
Console(config-if)#exit
Console(config)#ipv6 default-gateway 2001:DB8:2222:7272::254
Console(config)end

```

```
Console#show ipv6 interface
VLAN 1 is up
IPv6 is enabled.
Link-local address:
  fe80::260:3eff:fe11:6700%1/64
Global unicast address(es):
  2001:db8:2222:7272::66/64, subnet is 2001:db8:2222:7272::/64
Joined group address(es):
  ff02::1:ff00:66
  ff02::1:ff11:6700
  ff02::1
IPv6 link MTU is 1500 bytes
ND DAD is enabled, number of DAD attempts: 3.
ND retransmit interval is 1000 milliseconds
ND advertised retransmit interval is 0 milliseconds
ND reachable time is 30000 milliseconds
ND advertised reachable time is 0 milliseconds
ND advertised router lifetime is 1800 seconds

Console#show ipv6 default-gateway
IPv6 default gateway 2001:db8:2222:7272::254
Console#
```

DYNAMIC CONFIGURATION

Obtaining an IPv4 Address

If you select the “bootp” or “dhcp” option, the system will immediately start broadcasting service requests. IP will be enabled but will not function until a BOOTP or DHCP reply has been received. Requests are broadcast every few minutes using exponential backoff until IP configuration information is obtained from a BOOTP or DHCP server. BOOTP and DHCP values can include the IP address, subnet mask, and default gateway. If the DHCP/BOOTP server is slow to respond, you may need to use the “ip dhcp restart client” command to re-start broadcasting service requests.

Note that the “ip dhcp restart client” command can also be used to start broadcasting service requests for all VLANs configured to obtain address assignments through BOOTP or DHCP. It may be necessary to use this command when DHCP is configured on a VLAN, and the member ports which were previously shut down are now enabled.

If the “bootp” or “dhcp” option is saved to the startup-config file (step 6), then the switch will start broadcasting service requests as soon as it is powered on.

To automatically configure the switch by communicating with BOOTP or DHCP address allocation servers on the network, complete the following steps:

1. From the Global Configuration mode prompt, type “interface vlan 1” to access the interface-configuration mode. Press <Enter>.
2. At the interface-configuration mode prompt, use one of the following commands:
 - To obtain IP settings via DHCP, type “ip address dhcp” and press <Enter>.

- To obtain IP settings via BOOTP, type "ip address bootp" and press <Enter>.
3. Type "end" to return to the Privileged Exec mode. Press <Enter>.
 4. Wait a few minutes, and then check the IP configuration settings by typing the "show ip interface" command. Press <Enter>.
 5. Then save your configuration changes by typing "copy running-config startup-config." Enter the startup file name and press <Enter>.

```

Console(config)#interface vlan 1
Console(config-if)#ip address dhcp
Console(config-if)#end
Console#show ip interface
VLAN 1 is Administrative Up - Link Up
  Address is FC-0A-81-88-4C-A3
  Index: 1001, MTU: 1500
  Address Mode is DHCP
  IP Address: 192.168.0.2 Mask: 255.255.255.0
  Proxy ARP is disabled
Console#copy running-config startup-config
Startup configuration file name []: startup
\Write to FLASH Programming.

\Write to FLASH finish.
Success.

```

OBTAINING AN IPV6 ADDRESS

Link Local Address — There are several ways to configure IPv6 addresses. The simplest method is to automatically generate a "link local" address (identified by an address prefix in the range of FE80~FEBF). This address type makes the switch accessible over IPv6 for all devices attached to the same local subnet.

To generate an IPv6 link local address for the switch, complete the following steps:

1. From the Global Configuration mode prompt, type "interface vlan 1" to access the interface-configuration mode. Press <Enter>.
2. Type "ipv6 enable" and press <Enter>.

```

Console(config)#interface vlan 1
Console(config-if)#ipv6 enable
Console(config-if)#end
Console#show ipv6 interface
VLAN 1 is up
IPv6 is enabled.
Link-local address:
  fe80::fe0a:81ff:fe88:4ca3%1/64
Global unicast address(es):
  (None)
Joined group address(es):
  ff02::1:ff88:4ca3
  ff02::1

```

```
IPv6 link MTU is 1500 bytes
ND DAD is enabled, number of DAD attempts: 3.
ND retransmit interval is 1000 milliseconds
ND advertised retransmit interval is 0 milliseconds
ND reachable time is 30000 milliseconds
ND advertised reachable time is 0 milliseconds
ND advertised router lifetime is 1800 seconds
```

```
Console#
```

Address for Multi-segment Network — To generate an IPv6 address that can be used in a network containing more than one subnet, the switch can be configured to automatically generate a unique host address based on the local subnet address prefix received in router advertisement messages. (DHCP for IPv6 will also be supported in future software releases.)

To dynamically generate an IPv6 host address for the switch, complete the following steps:

1. From the Global Configuration mode prompt, type "interface vlan 1" to access the interface-configuration mode. Press <Enter>.
2. From the interface prompt, type "ipv6 address autoconfig" and press <Enter>.
3. Type "ipv6 enable" and press <Enter> to enable IPv6 on an interface that has not been configured with an explicit IPv6 address.

```
Console(config)#interface vlan 1
Console(config-if)#ipv6 address autoconfig
Console(config-if)#ipv6 enable
Console(config-if)#end
Console#show ipv6 interface
VLAN 1 is up
IPv6 is enabled
Link-local address:
  fe80::260:3eff:fe11:6700/64
Global unicast address(es):
  2001:db8:2222:7272:2e0:cff:fe00:fd/64, subnet is 2001:db8:2222:7272::/
  64[AUTOCONFIG]
  valid lifetime 2591978 preferred lifetime 604778
Joined group address(es):
  ff02::1:ff00:fd
  ff02::1:ff11:6700
  ff02::1
IPv6 link MTU is 1500 bytes
ND DAD is enabled, number of DAD attempts: 3.
ND retransmit interval is 1000 milliseconds
ND advertised retransmit interval is 0 milliseconds
ND reachable time is 30000 milliseconds
ND advertised reachable time is 0 milliseconds

Console#
```

DOWNLOADING A CONFIGURATION FILE REFERENCED BY A DHCP SERVER

Information passed on to the switch from a DHCP server may also include a configuration file to be downloaded and the TFTP servers where that file can be accessed. If the Factory Default Configuration file is used to provision the switch at startup, in addition to requesting IP configuration settings from the DHCP server, it will also ask for the name of a bootup configuration file and TFTP servers where that file is stored.

If the switch receives information that allows it to download the remote bootup file, it will save this file to a local buffer, and then restart the provision process.

Note the following DHCP client behavior:

- ◆ The bootup configuration file received from a TFTP server is stored on the switch with the original file name. If this file name already exists in the switch, the file is overwritten.
- ◆ If the name of the bootup configuration file is the same as the Factory Default Configuration file, the download procedure will be terminated, and the switch will not send any further DHCP client requests.
- ◆ If the switch fails to download the bootup configuration file based on information passed by the DHCP server, it will not send any further DHCP client requests.
- ◆ If the switch does not receive a DHCP response prior to completing the bootup process, it will continue to send a DHCP client request once a minute. These requests will only be terminated if the switch's address is manually configured, but will resume if the address mode is set back to DHCP.

To successfully transmit a bootup configuration file to the switch the DHCP daemon (using a Linux based system for this example) must be configured with the following information:

- ◆ Options 60, 66 and 67 statements can be added to the daemon's configuration file.

Table 3: Options 60, 66 and 67 Statements

Option	Statement	
	Keyword	Parameter
60	vendor-class-identifier	a string indicating the vendor class identifier
66	tftp-server-name	a string indicating the tftp server name
67	bootfile-name	a string indicating the bootfile name

- ◆ By default, DHCP option 66/67 parameters are not carried in a DHCP server reply. To ask for a DHCP reply with option 66/67 information, the DHCP client request sent by this switch includes a "parameter request list" asking for this information. Besides, the client request also includes a "vendor class identifier" that allows the DHCP server to identify the device, and select the appropriate configuration file for download. This information is included in Option 55 and 124.

Table 4: Options 55 and 124 Statements

Option	Statement	
	Keyword	Parameter
55	dhcp-parameter-request-list	a list of parameters, separated by ','
124	vendor-class-identifier	a string indicating the vendor class identifier

The following configuration examples are provided for a Linux-based DHCP daemon (dhcpd.conf file). In the "Vendor class" section, the server will always send Option 66 and 67 to tell the switch to download the "test" configuration file from server 192.168.255.101.

```
ddns-update-style ad-hoc;

default-lease-time 600;
max-lease-time 7200;

log-facility local7;

server-name "Server1";
Server-identifier 192.168.255.250;
#option 66, 67
option space dynamicProvision code width 1 length 1 hash size 2;
option dynamicProvision.tftp-server-name code 66 = text;
option dynamicProvision.bootfile-name code 67 = text;

subnet 192.168.255.0 netmask 255.255.255.0 {
    range 192.168.255.160 192.168.255.200;
    option routers 192.168.255.101;
    option tftp-server-name "192.168.255.100"; #Default Option 66
    option bootfile-name "bootfile";          #Default Option 67
}

class "Option66,67_1" {
    #DHCP Option 60 Vendor class two
    match if option vendor-class-identifier = "ecs4110-series.cfg";
    option tftp-server-name "192.168.255.101";
    option bootfile-name "test";
}
```



NOTE: Use "ecs4110-series.cfg" for the vendor-class-identifier in the dhcpd.conf file.

ENABLING SNMP MANAGEMENT ACCESS

The switch can be configured to accept management commands from Simple Network Management Protocol (SNMP) applications such as Edge-Core EView Pro. You can configure the switch to respond to SNMP requests or generate SNMP traps.

When SNMP management stations send requests to the switch (either to return information or to set a parameter), the switch provides the requested data or sets the specified parameter. The switch can also be configured to send information to SNMP managers (without being

requested by the managers) through trap messages, which inform the manager that certain events have occurred.

The switch includes an SNMP agent that supports SNMP version 1, 2c, and 3 clients. To provide management access for version 1 or 2c clients, you must specify a community string. The switch provides a default MIB View (i.e., an SNMPv3 construct) for the default "public" community string that provides read access to the entire MIB tree, and a default view for the "private" community string that provides read/write access to the entire MIB tree. However, you may assign new views to version 1 or 2c community strings that suit your specific security requirements (see ["Setting SNMPv3 Views" on page 458](#)).

COMMUNITY STRINGS (FOR SNMP VERSION 1 AND 2C CLIENTS)

Community strings are used to control management access to SNMP version 1 and 2c stations, as well as to authorize SNMP stations to receive trap messages from the switch. You therefore need to assign community strings to specified users, and set the access level.

The default strings are:

- ◆ **public** - with read-only access. Authorized management stations are only able to retrieve MIB objects.
- ◆ **private** - with read/write access. Authorized management stations are able to both retrieve and modify MIB objects.

To prevent unauthorized access to the switch from SNMP version 1 or 2c clients, it is recommended that you change the default community strings.

To configure a community string, complete the following steps:

1. From the Privileged Exec level global configuration mode prompt, type "snmp-server community *string mode*," where "string" is the community access string and "mode" is **rw** (read/write) or **ro** (read only). Press <Enter>. (Note that the default mode is read only.)
2. To remove an existing string, simply type "no snmp-server community *string*," where "string" is the community access string to remove. Press <Enter>.

```
Console(config)#snmp-server community admin rw
Console(config)#snmp-server community private
Console(config)#
```



NOTE: If you do not intend to support access to SNMP version 1 and 2c clients, we recommend that you delete both of the default community strings. If there are no community strings, then SNMP management access from SNMP v1 and v2c clients is disabled.

TRAP RECEIVERS

You can also specify SNMP stations that are to receive traps from the switch. To configure a trap receiver, use the "snmp-server host" command. From the Privileged Exec level global configuration mode prompt, type:

```
"snmp-server host host-address community-string
[version {1 | 2c | 3 {auth | noauth | priv}}]"
```

where "host-address" is the IP address for the trap receiver, "community-string" specifies access rights for a version 1/2c host, or is the user name of a version 3 host, "version" indicates the SNMP client version, and "auth | noauth | priv" means that authentication, no authentication, or authentication and privacy is used for v3 clients. Then press <Enter>. For a more detailed description of these parameters, see ["snmp-server host" on page 799](#). The following example creates a trap host for each type of SNMP client.

```
Console(config)#snmp-server host 10.1.19.23 batman
Console(config)#snmp-server host 10.1.19.98 robin version 2c
Console(config)#snmp-server host 10.1.19.34 barbie version 3 auth
Console(config)#
```

CONFIGURING ACCESS FOR SNMP VERSION 3 CLIENTS

To configure management access for SNMPv3 clients, you need to first create a view that defines the portions of MIB that the client can read or write, assign the view to a group, and then assign the user to a group. The following example creates one view called "mib-2" that includes the entire MIB-2 tree branch, and then another view that includes the IEEE 802.1d bridge MIB. It assigns these respective read and read/write views to a group call "r&d" and specifies group authentication via MD5 or SHA. In the last step, it assigns a v3 user to this group, indicating that MD5 will be used for authentication, provides the password "greenpeace" for authentication, and the password "einstien" for encryption.

```
Console(config)#snmp-server view mib-2 1.3.6.1.2.1 included
Console(config)#snmp-server view 802.1d 1.3.6.1.2.1.17 included
Console(config)#snmp-server group r&d v3 auth read mib-2 write 802.1d
Console(config)#snmp-server user steve group r&d v3 auth md5 greenpeace priv
des56 einstien
Console(config)#
```

For a more detailed explanation on how to configure the switch for access from SNMP v3 clients, refer to ["Simple Network Management Protocol" on page 452](#), or refer to the specific CLI commands for SNMP starting on [page 793](#).

MANAGING SYSTEM FILES

The switch's flash memory supports three types of system files that can be managed by the CLI program, web interface, or SNMP. The switch's file system allows files to be uploaded and downloaded, copied, deleted, and set as a start-up file.

The types of files are:

- ◆ **Configuration** — This file type stores system configuration information and is created when configuration settings are saved. Saved configuration files can be selected as a system start-up file or can be uploaded via FTP/TFTP to a server for backup. The file named "Factory_Default_Config.cfg" contains all the system default settings and cannot be deleted from the system. If the system is booted with the factory default settings, the switch will also create a file named "startup1.cfg" that contains system settings for switch initialization, including information about the unit identifier, and MAC address for the switch. The configuration settings from the factory defaults configuration file are copied to this file, which is then used to boot the switch. See ["Saving or Restoring Configuration Settings" on page 99](#) for more information.
- ◆ **Operation Code** — System software that is executed after boot-up, also known as run-time code. This code runs the switch operations and provides the CLI and web management interfaces. See ["Managing System Files" on page 129](#) for more information.
- ◆ **Diagnostic Code** — Software that is run during system boot-up, also known as POST (Power On Self-Test).

Due to the size limit of the flash memory, the switch supports only two operation code files. However, you can have as many diagnostic code files and configuration files as available flash memory space allows. The switch has a total of 32 Mbytes of flash memory for system files.

In the system flash memory, one file of each type must be set as the start-up file. During a system boot, the diagnostic and operation code files set as the start-up file are run, and then the start-up configuration file is loaded.

Note that configuration files should be downloaded using a file name that reflects the contents or usage of the file settings. If you download directly to the running-config, the system will reboot, and the settings will have to be copied from the running-config to a permanent file.

SAVING OR RESTORING CONFIGURATION SETTINGS

Configuration commands only modify the running configuration file and are not saved when the switch is rebooted. To save all your configuration changes in nonvolatile storage, you must copy the running configuration file to the start-up configuration file using the "copy" command.

New startup configuration files must have a name specified. File names on the switch are case-sensitive, can be from 1 to 31 characters, must not

contain slashes (\ or /), and the leading letter of the file name must not be a period (.). (Valid characters: A-Z, a-z, 0-9, ".", "-", "_")

There can be more than one user-defined configuration file saved in the switch's flash memory, but only one is designated as the "startup" file that is loaded when the switch boots. The **copy running-config startup-config** command always sets the new file as the startup file. To select a previously saved configuration file, use the **boot system config:<filename>** command.

The maximum number of saved configuration files depends on available flash memory. The amount of available flash memory can be checked by using the **dir** command.

To save the current configuration settings, enter the following command:

1. From the Privileged Exec mode prompt, type "copy running-config startup-config" and press <Enter>.
2. Enter the name of the start-up file. Press <Enter>.

```
Console#copy running-config startup-config
Startup configuration file name []: startup
\Write to FLASH Programming.

\Write to FLASH finish.
Success.

Console#
```

To restore configuration settings from a backup server, enter the following command:

1. From the Privileged Exec mode prompt, type "copy tftp startup-config" and press <Enter>.
2. Enter the address of the TFTP server. Press <Enter>.
3. Enter the name of the startup file stored on the server. Press <Enter>.
4. Enter the name for the startup file on the switch. Press <Enter>.

```
Console#copy file startup-config
Console#copy tftp startup-config
TFTP server IP address: 192.168.0.4
Source configuration file name: startup-rd.cfg
Startup configuration file name [startup1.cfg]:

Success.
Console#
```

SECTION II

WEB CONFIGURATION

This section describes the basic switch features, along with a detailed description of how to configure each feature via a web browser.

This section includes these chapters:

- ◆ ["Using the Web Interface" on page 103](#)
- ◆ ["Basic Management Tasks" on page 123](#)
- ◆ ["Interface Configuration" on page 155](#)
- ◆ ["VLAN Configuration" on page 199](#)
- ◆ ["Address Table Settings" on page 231](#)
- ◆ ["Spanning Tree Algorithm" on page 239](#)
- ◆ ["Congestion Control" on page 263](#)
- ◆ ["Class of Service" on page 273](#)
- ◆ ["Quality of Service" on page 287](#)
- ◆ ["VoIP Traffic Configuration" on page 303](#)
- ◆ ["Security Measures" on page 309](#)
- ◆ ["Basic Administration Protocols" on page 421](#)
- ◆ ["Multicast Filtering" on page 567](#)
- ◆ ["IP Configuration" on page 639](#)
- ◆ ["IP Services" on page 663](#)

- ◆ ["General IP Routing" on page 679](#)

This switch provides an embedded HTTP web agent. Using a web browser you can configure the switch and view statistics to monitor network activity. The web agent can be accessed by any computer on the network using a standard web browser (Internet Explorer 6, Mozilla Firefox 4, or Google Chrome 29, or more recent versions).



NOTE: You can also use the Command Line Interface (CLI) to manage the switch over a serial connection to the console port or via Telnet. For more information on using the CLI, refer to ["Using the Command Line Interface" on page 697](#).

CONNECTING TO THE WEB INTERFACE

Prior to accessing the switch from a web browser, be sure you have first performed the following tasks:

1. Configure the switch with a valid IP address, subnet mask, and default gateway using an out-of-band serial connection, BOOTP or DHCP protocol. (See ["Setting an IP Address" on page 89](#).)
2. Set user names and passwords using an out-of-band serial connection. Access to the web agent is controlled by the same user names and passwords as the onboard configuration program. (See ["Setting Passwords" on page 88](#).)
3. After you enter a user name and password, you will have access to the system configuration program.



NOTE: You are allowed three attempts to enter the correct password; on the third failed attempt the current connection is terminated.

NOTE: If you log into the web interface as guest (Normal Exec level), you can view the configuration settings or change the guest password. If you log in as "admin" (Privileged Exec level), you can change the settings on any page.

NOTE: If the path between your management station and this switch does not pass through any device that uses the Spanning Tree Algorithm, then you can set the switch port attached to your management station to fast forwarding (i.e., enable Admin Edge Port) to improve the switch's response time to management commands issued through the web interface. See ["Configuring Interface Settings for STA" on page 250](#).

NOTE: Users are automatically logged off of the HTTP server or HTTPS server if no input is detected for 600 seconds.

NOTE: Connection to the web interface is not supported for HTTPS using an IPv6 link local address.

NAVIGATING THE WEB BROWSER INTERFACE

To access the web-browser interface you must first enter a user name and password. The administrator has Read/Write access to all configuration parameters and statistics. The default user name and password for the administrator is "admin."

HOME PAGE When your web browser connects with the switch's web agent, the home page is displayed as shown below. The home page displays the Main Menu on the left side of the screen and System Information on the right side. The Main Menu links are used to navigate to other menus, and display configuration parameters and statistics.

Figure 1: Home Page

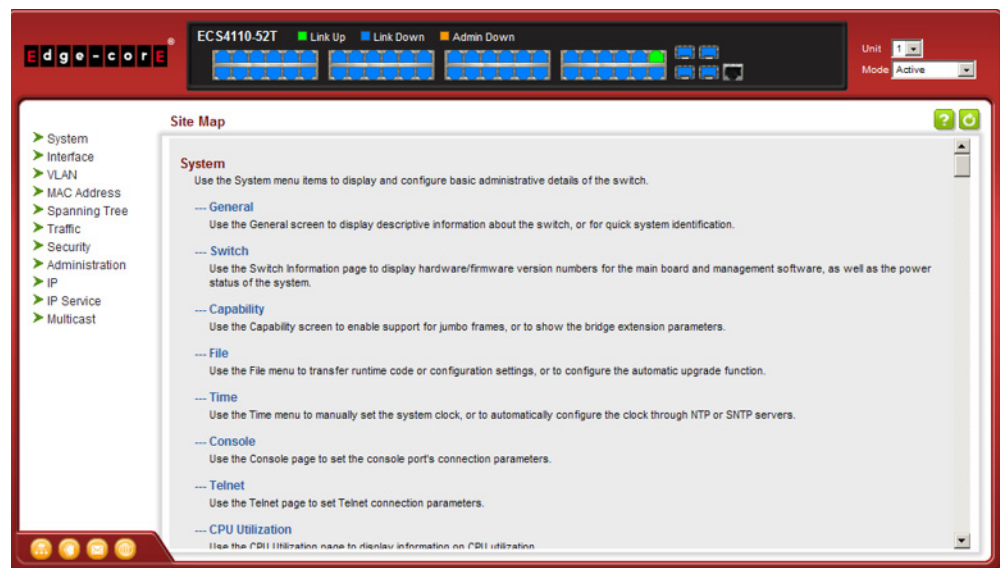







NOTE: This manual covers the ECS4110-28T, ECS4110-28P, ECS4110-52T and ECS4110-52P Gigabit Ethernet switches. Other than the difference in port count and support for PoE (ECS4110-28P/52P), there are no other significant differences. Therefore nearly all of the screen display examples are based on the ECS4110-52T. The panel graphics for all of switch types are shown on the following page.

NOTE: You can open a connection to the vendor's web site by clicking on the Edge-Core logo.

CONFIGURATION OPTIONS Configurable parameters have a dialog box or a drop-down list. Once a configuration change has been made on a page, be sure to click on the Apply button to confirm the new setting. The following table summarizes the web page configuration buttons.

Table 5: Web Page Configuration Buttons

Button	Action
Apply	Sets specified values to the system.
Revert	Cancels specified values and restores current values prior to pressing "Apply."
	Displays help for the selected page.
	Refreshes the current page.
	Displays the site map.
	Logs out of the management interface.
	Links to the manufacture's web site.
	Sends mail to the manufacturer.

PANEL DISPLAY The web agent displays an image of the switch's ports. The Mode can be set to display different information for the ports, including Active (i.e., up or down), Duplex (i.e., half or full duplex), or Flow Control (i.e., with or without flow control).

Figure 2: Front Panel Indicators

ECS4110-28T

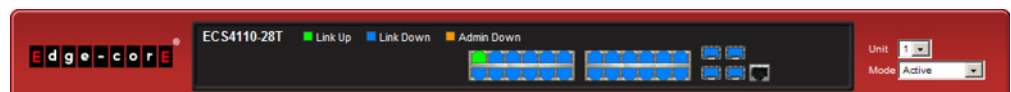

ECS4110-28P

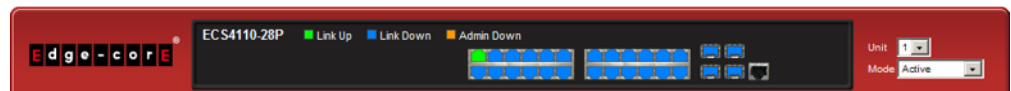

ECS4110-52T

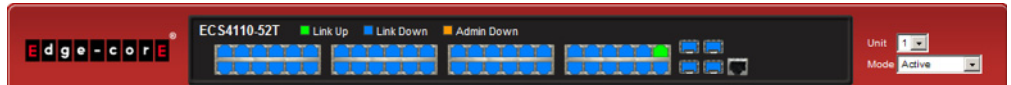

ECS4110-52P

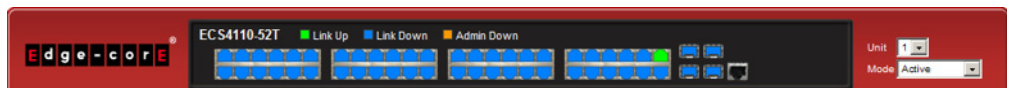

MAIN MENU Using the onboard web agent, you can define system parameters, manage and control the switch, and all its ports, or monitor network conditions. The following table briefly describes the selections available from this program.

Table 6: Switch Main Menu

Menu	Description	Page
System		
General	Provides basic system description, including contact information	123
Switch	Shows the number of ports, hardware version, power status, and firmware version numbers	125
Capability	Enables support for jumbo frames; shows the bridge extension parameters	126, 127
File		129
Copy	Allows the transfer and copying files	129
Set Startup	Sets the startup file	132
Show	Shows the files stored in flash memory; allows deletion of files	132
Automatic Operation Code Upgrade	Automatically upgrades operation code if a newer version is found on the server	133
Time		137
Configure General		
Manual	Manually sets the current time	137
SNTP	Configures SNTP polling interval	138
NTP	Configures NTP authentication parameters	139
Configure Time Server	Configures a list of SNTP servers	140
Configure SNTP Server	Sets the IP address for SNTP time servers	140
Add NTP Server	Adds NTP time server and index of authentication key	141
Show NTP Server	Shows list of configured NTP time servers	141
Add NTP Authentication Key	Adds key index and corresponding MD5 key	142
Show NTP Authentication Key	Shows list of configured authentication keys	142
Configure Time Zone	Sets the local time zone for the system clock	144
Console	Sets console port connection parameters	145
Telnet	Sets Telnet connection parameters	146
CPU Utilization	Displays information on CPU utilization	148
Memory Status	Shows memory utilization parameters	149
Reset	Restarts the switch immediately, at a specified time, after a specified delay, or at a periodic interval	150
Interface		155
Port		156
General		
Configure by Port List	Configures connection settings per port	156
Configure by Port Range	Configures connection settings for a range of ports	158

Table 6: Switch Main Menu (Continued)

Menu	Description	Page
Show Information	Displays port connection status	159
Mirror		160
Add	Sets the source and target ports for mirroring	160
Show	Shows the configured mirror sessions	160
Statistics	Shows Interface, Etherlike, and RMON port statistics	166
Chart	Shows Interface, Etherlike, and RMON port statistics	166
Transceiver	Shows identifying information and operational parameters for optical transceivers which support Digital Diagnostic Monitoring (DDM), and configures thresholds for alarm and warning messages for optical transceivers which support DDM	170, 172
Cable Test	Performs cable diagnostics for selected port to diagnose any cable faults (short, open etc.) and report the cable length	174
Trunk		
Static		177
Configure Trunk	Creates a trunk, specifying port members	177
Add	Creates a trunk, along with the first port member	177
Show	Shows the configured trunk identifiers	177
Add Member	Specifies ports to group into static trunks	177
Show Member	Shows the port members for the selected trunk	177
Configure General		177
Configure	Configures trunk connection settings	177
Show Information	Displays trunk connection settings	177
Dynamic		179
Configure Aggregator	Configures administration key for specific LACP groups	179
Configure Aggregation Port		177
Configure		177
General	Allows ports to dynamically join trunks	179
Actor	Configures parameters for link aggregation group members on the local side	179
Partner	Configures parameters for link aggregation group members on the remote side	179
Show Information		185
Counters	Displays statistics for LACP protocol messages	185
Internal	Displays configuration settings and operational state for the local side of a link aggregation	187
Neighbors	Displays configuration settings and operational state for the remote side of a link aggregation	188
Configure Trunk		179
Show	Displays trunk connection settings	179
Configure	Configures trunk connection settings	179
Show Member	Show port members of dynamic trunks	179

Table 6: Switch Main Menu (Continued)

Menu	Description	Page
Statistics	Shows Interface, Etherlike, and RMON port statistics	166
Chart	Shows Interface, Etherlike, and RMON port statistics	166
Load Balance	Sets the load-distribution method among ports in aggregated links	
Green Ethernet	Adjusts the power provided to ports based on the length of the cable used to connect to other devices	191
RSPAN	Mirrors traffic from remote switches for analysis at a destination port on the local switch	162
Traffic Segmentation		193
Configure Global	Enables traffic segmentation globally	193
Configure Session	Configures the uplink and down-link ports for a segmented group of ports	194
VLAN Trunking	Allows unknown VLAN groups to pass through the specified interface	196
VLAN	Virtual LAN	199
Static		
Add	Creates VLAN groups	202
Show	Displays configured VLAN groups	202
Modify	Configures group name and administrative status	202
Edit Member by VLAN	Specifies VLAN attributes per VLAN	205
Edit Member by Interface	Specifies VLAN attributes per interface	205
Edit Member by Interface Range	Specifies VLAN attributes per interface range	205
Dynamic		209
Configure General	Enables GVRP VLAN registration protocol globally	209
Configure Interface	Configures GVRP status and timers per interface	209
Show Dynamic VLAN		209
Show VLAN	Shows the VLANs this switch has joined through GVRP	209
Show VLAN Member	Shows the interfaces assigned to a VLAN through GVRP	209
Tunnel	IEEE 802.1Q (QinQ) Tunneling	212
Configure Global	Sets tunnel mode for the switch	216
Configure Interface	Sets the tunnel mode for any participating interface	219
Protocol		220
Configure Protocol		221
Add	Creates a protocol group, specifying supported protocols	221
Show	Shows configured protocol groups	221
Configure Interface		222
Add	Maps a protocol group to a VLAN	222
Show	Shows the protocol groups mapped to each VLAN	222

Table 6: Switch Main Menu (Continued)

Menu	Description	Page
IP Subnet		225
Add	Maps IP subnet traffic to a VLAN	225
Show	Shows IP subnet to VLAN mapping	225
MAC-Based		227
Add	Maps traffic with specified source MAC address to a VLAN	227
Show	Shows source MAC address to VLAN mapping	227
Mirror		229
Add	Mirrors traffic from one or more source VLANs to a target port	229
Show	Shows mirror list	229
MAC Address		231
Learning Status	Enables MAC address learning on selected interfaces	231
Static		233
Add	Configures static entries in the address table	233
Show	Displays static entries in the address table	233
Dynamic		
Configure Aging	Sets timeout for dynamically learned entries	234
Show Dynamic MAC	Displays dynamic entries in the address table	235
Clear Dynamic MAC	Removes any learned entries from the forwarding database and clears the transmit and receive counts for any static or system configured entries	236
Mirror		237
Add	Mirrors traffic matching a specified source address from any port on the switch to a target port	237
Show	Shows mirror list	237
Spanning Tree		239
Loopback Detection	Configures Loopback Detection parameters	242
STA	Spanning Tree Algorithm	
Configure Global		
Configure	Configures global bridge settings for STP, RSTP and MSTP	243
Show Information	Displays STA values used for the bridge	249
Configure Interface		
Configure	Configures interface settings for STA	250
Show Information	Displays interface settings for STA	254
MSTP	Multiple Spanning Tree Algorithm	257
Configure Global		257
Add	Configures initial VLAN and priority for an MST instance	257
Show	Shows configured MST instances	257
Modify	Modifies priority for an MST instance	257

Table 6: Switch Main Menu (Continued)

Menu	Description	Page
Add Member	Adds VLAN members for an MST instance	257
Show Member	Adds or deletes VLAN members for an MST instance	257
Show Information	Shows global settings for an MST instance	257
Configure Interface		261
Configure	Configures interface settings for an MST instance	261
Show Information	Displays interface settings for an MST instance	261
Traffic		
Rate Limit	Sets the input and output rate limits for a port	263
Storm Control	Sets the traffic storm threshold for each interface	264
Auto Traffic Control	Sets thresholds for broadcast and multicast storms which can be used to trigger configured rate limits or to shut down a port	266
Configure Global	Sets the time to apply the control response after traffic has exceeded the upper threshold, and the time to release the control response after traffic has fallen beneath the lower threshold	268
Configure Interface	Sets the storm control mode (broadcast or multicast), the traffic thresholds, the control response, to automatically release a response of rate limiting, or to send related SNMP trap messages	269
Priority		
Default Priority	Sets the default priority for each port or trunk	273
Queue	Sets queue mode for the switch; sets the service weight for each queue that will use a weighted or hybrid mode	274
Trust Mode	Selects IP Precedence, DSCP or CoS priority processing	280
DSCP to DSCP		281
Add	Maps DSCP values in incoming packets to per-hop behavior and drop precedence values for internal priority processing	281
Show	Shows the DSCP to DSCP mapping list	281
CoS to DSCP		283
Add	Maps CoS/CFI values in incoming packets to per-hop behavior and drop precedence values for priority processing	283
Show	Shows the CoS to DSCP mapping list	283
PHB to Queue		277
Add	Maps internal per-hop behavior values to hardware queues	277
Show	Shows the PHB to Queue mapping list	277
DiffServ		287
Configure Class		288
Add	Creates a class map for a type of traffic	288
Show	Shows configured class maps	288
Modify	Modifies the name of a class map	288
Add Rule	Configures the criteria used to classify ingress traffic	288
Show Rule	Shows the traffic classification rules for a class map	288

Table 6: Switch Main Menu (Continued)

Menu	Description	Page
Configure Policy		291
Add	Creates a policy map to apply to multiple interfaces	291
Show	Shows configured policy maps	291
Modify	Modifies the name of a policy map	291
Add Rule	Sets the boundary parameters used for monitoring inbound traffic, and the action to take for conforming and non-conforming traffic	291
Show Rule	Shows the rules used to enforce bandwidth policing for a policy map	291
Configure Interface	Applies a policy map to an ingress port	301
VoIP	Voice over IP	303
Configure Global	Configures auto-detection of VoIP traffic, sets the Voice VLAN, and VLAN aging time	304
Configure OUI		305
Add	Maps the OUI in the source MAC address of ingress packets to the VoIP device manufacturer	305
Show	Shows the OUI telephony list	305
Configure Interface	Configures VoIP traffic settings for ports, including the way in which a port is added to the Voice VLAN, filtering of non-VoIP packets, the method of detecting VoIP traffic, and the priority assigned to the voice traffic	306
Security		309
AAA	Authentication, Authorization and Accounting	310
System Authentication	Configures authentication sequence – local, RADIUS, and TACACS	311
Server		312
Configure Server	Configures RADIUS and TACACS server message exchange settings	312
Configure Group		312
Add	Specifies a group of authentication servers and sets the priority sequence	312
Show	Shows the authentication server groups and priority sequence	312
Accounting	Enables accounting of requested services for billing or security purposes	317
Configure Global	Specifies the interval at which the local accounting service updates information to the accounting server	317
Configure Method		317
Add	Configures accounting for various service types	317
Show	Shows the accounting settings used for various service types	317
Configure Service	Sets the accounting method applied to specific interfaces for 802.1X, CLI command privilege levels for the console port, and for Telnet	317
Show Information		317
Summary	Shows the configured accounting methods, and the methods applied to specific interfaces	317
Statistics	Shows basic accounting information recorded for user sessions	317

Table 6: Switch Main Menu (Continued)

Menu	Description	Page
Authorization	Enables authorization of requested services	323
Configure Method		323
Add	Configures authorization for various service types	323
Show	Shows the authorization settings used for various service types	323
Configure Service	Sets the authorization method applied used for the console port, and for Telnet	323
Show Information	Shows the configured authorization methods, and the methods applied to specific interfaces	323
User Accounts		326
Add	Configures user names, passwords, and access levels	326
Show	Shows authorized users	326
Modify	Modifies user attributes	326
Web Authentication	Allows authentication and access to the network when 802.1X or Network Access authentication are infeasible or impractical	328
Configure Global	Configures general protocol settings	329
Configure Interface	Enables Web Authentication for individual ports	330
Network Access	MAC address-based network access authentication	331
Configure Global	Enables aging for authenticated MAC addresses, and sets the time period after which a connected MAC address must be reauthenticated	333
Configure Interface		334
General	Enables MAC authentication on a port; sets the maximum number of address that can be authenticated, the guest VLAN, dynamic VLAN and dynamic QoS	334
Link Detection	Configures detection of changes in link status, and the response (i.e., send trap or shut down port)	336
Configure MAC Filter		337
Add	Specifies MAC addresses exempt from authentication	337
Show	Shows the list of exempt MAC addresses	337
Show Information	Shows the authenticated MAC address list	339
HTTPS	Secure HTTP	341
Configure Global	Enables HTTPSs, and specifies the UDP port to use	341
Copy Certificate	Replaces the default secure-site certificate	342
SSH	Secure Shell	344
Configure Global	Configures SSH server settings	347
Configure Host Key		348
Generate	Generates the host key pair (public and private)	348
Show	Displays RSA and DSA host keys; deletes host keys	348
Configure User Key		350
Copy	Imports user public keys from TFTP server	350
Show	Displays RSA and DSA user keys; deletes user keys	350

Table 6: Switch Main Menu (Continued)

Menu	Description	Page
ACL	Access Control Lists	352
Configure Time Range	Configures the time to apply an ACL	352
Add	Specifies the name of a time range	353
Show	Shows the name of configured time ranges	353
Add Rule		353
Absolute	Sets exact time or time range	353
Periodic	Sets a recurrent time	353
Show Rule	Shows the time specified by a rule	353
Configure ACL		357
Show TCAM	Shows utilization parameters for TCAM	356
Add	Adds an ACL based on IP or MAC address filtering	357
Show	Shows the name and type of configured ACLs	357
Add Rule	Configures packet filtering based on IP or MAC addresses and other packet attributes	357
Show Rule	Shows the rules specified for an ACL	357
Configure Interface	Binds a port to the specified ACL and time range	
Configure	Binds a port to the specified ACL and time range	371
Add Mirror	MIRrors matching traffic to the specified port	372
Show Mirror	Shows ACLs mirrored to specified port	372
Show Hardware Counters	Shows statistics for ACL hardware counters	374
ARP Inspection		375
Configure General	Enables inspection globally, configures validation of additional address components, and sets the log rate for packet inspection	376
Configure VLAN	Enables ARP inspection on specified VLANs	378
Configure Interface	Sets the trust mode for ports, and sets the rate limit for packet inspection	380
Show Information		
Show Statistics	Displays statistics on the inspection process	381
Show Log	Shows the inspection log list	382
IP Filter		383
Add	Sets IP addresses of clients allowed management access via the web, SNMP, and Telnet	383
Show	Shows the addresses to be allowed management access	383
Port Security	Configures per port security, including status, response for security breach, and maximum allowed MAC addresses	385
Port Authentication	IEEE 802.1X	387
Configure Global	Enables authentication and EAPOL pass-through	389
Configure Interface	Sets authentication parameters for individual ports	
Authenticator	Sets port authenticator settings	390

Table 6: Switch Main Menu (Continued)

Menu	Description	Page
Supplicant	Sets port supplicant settings	394
Show Statistics	Displays protocol statistics for the selected port	396
Authenticator	Displays protocol statistics for port authenticator	396
Supplicant	Displays protocol statistics for port supplicant	396
DoS Protection	Protects against Denial-of-Service attacks	399
IP Source Guard	Filters IP traffic based on static entries in the IP Source Guard table, or dynamic entries in the DHCP Snooping table	401
Port Configuration	Enables IP source guard and selects filter type per port	401
Static Binding		403
Add	Adds a static addresses to the source-guard binding table	403
Show	Shows static addresses in the source-guard binding table	403
Dynamic Binding	Displays the source-guard binding table for a selected interface	405
IPv6 Source Guard	Filters IPv6 traffic based on static entries in the IP Source Guard table, or dynamic entries in the DHCP Snooping table	406
Port Configuration	Enables IPv6 source guard and selects filter type per port	406
Static Binding		409
Add	Adds a static addresses to the source-guard binding table	409
Show	Shows static addresses in the source-guard binding table	409
Dynamic Binding	Displays the source-guard binding table for a selected interface	411
Administration		421
Log		422
System		422
Configure Global	Stores error messages in local memory	422
Show Logs	Shows logged error messages	422
Remote	Configures the logging of messages to a remote logging process	424
SMTP	Sends an SMTP client message to a participating server	425
Configure Server	Configures a list of recipient SMTP servers	425
Add	Adds a recipient SMTP server	425
Show	Shows configured SMTP servers	425
Configure General	Sets SMTP status, e-mail source and destination addresses	425
LLDP		427
Configure Global	Configures global LLDP timing parameters	427
Configure Interface		
Configure General	Sets the message transmission mode, enables SNMP notification, and sets the LLDP attributes to advertise	429
Add CA-Type	Specifies the location of the device attached to an interface	433
Show CA-Type	Shows the location of the device attached to an interface	433
Modify CA-Type	Modifies the location of the device attached to an interface	433

Table 6: Switch Main Menu (Continued)

Menu	Description	Page
Show Local Device Information		435
General	Displays general information about the local device	435
Port/Trunk	Displays information about each interface	435
Show Remote Device Information		438
Port/Trunk	Displays information about a remote device connected to a port on this switch	438
Port/Trunk Details	Displays detailed information about a remote device connected to this switch	438
Show Device Statistics		446
General	Displays statistics for all connected remote devices	446
Port/Trunk	Displays statistics for remote devices on a selected port or trunk	446
PoE*	Power over Ethernet	448
PSE	Enables PSE power	450
SNMP	Simple Network Management Protocol	452
Configure Global	Enables SNMP agent status, and sets related trap functions	454
Configure Engine		456
Set Engine ID	Sets the SNMP v3 engine ID on this switch	456
Add Remote Engine	Sets the SNMP v3 engine ID for a remote device	457
Show Remote Engine	Shows configured engine ID for remote devices	457
Configure View		458
Add View	Adds an SNMP v3 view of the OID MIB	458
Show View	Shows configured SNMP v3 views	458
Add OID Subtree	Specifies a part of the subtree for the selected view	458
Show OID Subtree	Shows the subtrees assigned to each view	458
Configure Group		461
Add	Adds a group with access policies for assigned users	461
Show	Shows configured groups and access policies	461
Configure User		
Add Community	Configures community strings and access mode	466
Show Community	Shows community strings and access mode	466
Add SNMPv3 Local User	Configures SNMPv3 users on this switch	467
Show SNMPv3 Local User	Shows SNMPv3 users configured on this switch	467
Change SNMPv3 Local User Group	Assign a local user to a new group	467
Add SNMPv3 Remote User	Configures SNMPv3 users from a remote device	469
Show SNMPv3 Remote User	Shows SNMPv3 users set from a remote device	467

Table 6: Switch Main Menu (Continued)

Menu	Description	Page
Configure Trap		472
Add	Configures notification managers to receive messages on key events that occur this switch	472
Show	Shows configured notification managers	472
Configure Notify Filter		476
Add	Creates an SNMP notification log	476
Show	Shows the configured notification logs	476
Show Statistics	Shows the status of SNMP communications	478
RMON	Remote Monitoring	480
Configure Global		
Add		
Alarm	Sets threshold bounds for a monitored variable	481
Event	Creates a response event for an alarm	483
Show		
Alarm	Shows all configured alarms	481
Event	Shows all configured events	483
Configure Interface		
Add		
History	Periodically samples statistics on a physical interface	485
Statistics	Enables collection of statistics on a physical interface	488
Show		
History	Shows sampling parameters for each entry in the history group	485
Statistics	Shows sampling parameters for each entry in the statistics group	488
Show Details		
History	Shows sampled data for each entry in the history group	485
Statistics	Shows sampled data for each entry in the history group	488
Cluster		490
Configure Global	Globally enables clustering for the switch; sets Commander status	491
Configure Member		
Add	Adds switch Members to the cluster	492
Show	Shows cluster members	492
Show Candidate	Shows cluster candidates	492
Show Member	Shows cluster switch member; managed switch members	494
ERPS	Ethernet Ring Protection Switching	495
Configure Global	Activates ERPS globally	499
Configure Domain		500
Add	Creates an ERPS ring	500

Table 6: Switch Main Menu (Continued)

Menu	Description	Page
Show	Shows list of configured ERPS rings, status, and settings	500
Configure Details	Configures ring parameters	500
Configure Operation	Blocks a ring port using Forced Switch or Manual Switch commands	516
CFM	Connectivity Fault Management	520
Configure Global	Configures global settings, including administrative status, cross-check start delay, link trace, and SNMP traps	523
Configure Interface	Configures administrative status on an interface	527
Configure MD	Configure Maintenance Domains	527
Add	Defines a portion of the network for which connectivity faults can be managed, identified by an MD index, maintenance level, and the MIP creation method	527
Configure Details	Configures the archive hold time and fault notification settings	527
Show	Shows list of configured maintenance domains	527
Configure MA	Configure Maintenance Associations	532
Add	Defines a unique CFM service instance, identified by its parent MD, the MA index, the VLAN assigned to the MA, and the MIP creation method	532
Configure Details	Configures detailed settings, including continuity check status and interval level, cross-check status, and alarm indication signal parameters	532
Show	Shows list of configured maintenance associations	532
Configure MEP	Configures Maintenance End Points	537
Add	Configures MEPs at the domain boundary to provide management access for each maintenance association	537
Show	Shows list of configured maintenance end points	537
Configure Remote MEP	Configures Remote Maintenance End Points	538
Add	Configures a static list of remote MEPs for comparison against the MEPs learned through continuity check messages	538
Show	Shows list of configured remote maintenance end points	538
Transmit Link Trace	Sends link trace messages to isolate connectivity faults by tracing the path through a network to the designated target node	540
Transmit Loopback	Sends loopback messages to isolate connectivity faults by requesting a target node to echo the message back to the source	542
Transmit Delay Measure	Sends periodic delay-measure requests to a specified MEP within a maintenance association	544
Show Information		
Show Local MEP	Shows the MEPs configured on this device	546
Show Local MEP Details	Displays detailed CFM information about a specified local MEP in the continuity check database	547
Show Local MIP	Shows the MIPs on this device discovered by the CFM protocol	548
Show Remote MEP	Shows MEPs located on other devices which have been discovered through continuity check messages, or statically configured in the MEP database	549

Table 6: Switch Main Menu (Continued)

Menu	Description	Page
Show Remote MEP Details	Displays detailed CFM information about a specified remote MEP in the continuity check database	550
Show Link Trace Cache	Shows information about link trace operations launched from this device	552
Show Fault Notification Generator	Displays configuration settings for the fault notification generator	554
Show Continuity Check Error	Displays CFM continuity check errors logged on this device	555
OAM	Operation, Administration, and Maintenance	556
Interface	Enables OAM on specified port, sets the mode to active or passive, and enables the reporting of critical events or errored frame events	556
Counters	Displays statistics on OAM PDUs	559
Event Log	Displays the log for recorded link events	560
Remote Interface	Displays information about attached OAM-enabled devices	561
Remote Loopback	Performs a loopback test on the specified port	562
IP		639
General		
Routing Interface		639
Add Address	Configures an IP interface for a VLAN	639
Show Address	Shows the IP interfaces assigned to a VLAN	639
Ping	Sends ICMP echo request packets to another node on the network	683
Trace Route	Shows the route packets take to the specified destination	684
ARP	Address Resolution Protocol	686
Configure General	Enables or disables proxy ARP for the specified VLAN	686
Configure Static Address		688
Add	Statically maps a physical address to an IP address	688
Show	Shows the MAC to IP address static table	688
Show Information	Shows entries in the Address Resolution Protocol (ARP) cache	689
Dynamic Address	Shows dynamically learned entries in the IP routing table	689
Other Address	Shows internal addresses used by the switch	689
Statistics	Shows statistics on ARP requests sent and received	690
Routing		679
Static Routes		691
Add	Configures static routing entries	691
Show	Shows static routing entries	691
Modify	Modifies the selected static routing entry	691
Routing Table		693
Show Information	Shows all routing entries, including local and static routes	693

Table 6: Switch Main Menu (Continued)

Menu	Description	Page
IPv6 Configuration		643
Configure Global	Sets an IPv6 default gateway for traffic with no known next hop	643
Configure Interface	Configures IPv6 interface address using auto-configuration or link-local address, and sets related protocol settings	644
Add IPv6 Address	Adds an global unicast, EUI-64, or link-local IPv6 address to an interface	650
Show IPv6 Address	Show the IPv6 addresses assigned to an interface	652
Show IPv6 Neighbor Cache	Displays information in the IPv6 neighbor discovery cache	654
Show Statistics		655
IPv6	Shows statistics about IPv6 traffic	655
ICMPv6	Shows statistics about ICMPv6 messages	655
UDP	Shows statistics about UDP messages	655
Show MTU	Shows the maximum transmission unit (MTU) cache for destinations that have returned an ICMP packet-too-big message along with an acceptable MTU to this switch	661
IP Service		663
DNS	Domain Name Service	663
General		663
Configure Global	Enables DNS lookup; defines the default domain name appended to incomplete host names	663
Add Domain Name	Defines a list of domain names that can be appended to incomplete host names	664
Show Domain Names	Shows the configured domain name list	664
Add Name Server	Specifies IP address of name servers for dynamic lookup	666
Show Name Servers	Shows the name server address list	666
Static Host Table		667
Add	Configures static entries for domain name to address mapping	667
Show	Shows the list of static mapping entries	667
Modify	Modifies the static address mapped to the selected host name	667
Cache	Displays cache entries discovered by designated name servers	668
DHCP	Dynamic Host Configuration Protocol	669
Client	Specifies the DHCP client identifier for an interface	669
Relay	Configures DHCP relay service for attached host devices	671
Snooping		412
Configure Global	Enables DHCP snooping globally, MAC-address verification, information option; and sets the information policy	415
Configure VLAN	Enables DHCP snooping on a VLAN	416
Configure Interface	Sets the trust mode for an interface	417
Show Information	Displays the DHCP Snooping binding information	418

Table 6: Switch Main Menu (Continued)

Menu	Description	Page
PPPoE Intermediate Agent		672
Configure Global	Enables PPPoE IA on the switch, sets access node identifier, sets generic error message	672
Configure Interface	Enables PPPoE IA on an interface, sets trust status, enables vendor tag stripping, sets circuit ID and remote ID	674
Show Statistics	Shows statistics on PPPoE IA protocol messages	676
Multicast		567
IGMP Snooping		568
General	Enables multicast filtering; configures parameters for multicast snooping	570
Multicast Router		574
Add Static Multicast Router	Assigns ports that are attached to a neighboring multicast router	574
Show Static Multicast Router	Displays ports statically configured as attached to a neighboring multicast router	574
Show Current Multicast Router	Displays ports attached to a neighboring multicast router, either through static or dynamic configuration	574
IGMP Member		576
Add Static Member	Statically assigns multicast addresses to the selected VLAN	576
Show Static Member	Shows multicast addresses statically configured on the selected VLAN	576
Show Current Member	Shows multicast addresses associated with the selected VLAN, either through static or dynamic configuration	576
Interface		578
Configure VLAN	Configures IGMP snooping per VLAN interface	578
Show VLAN Information	Shows IGMP snooping settings per VLAN interface	578
Configure Interface	Configures the interface to drop IGMP query packets or all multicast data packets	584
Forwarding Entry	Displays the current multicast groups learned through IGMP Snooping	585
Filter		590
Configure General	Enables IGMP filtering for the switch	590
Configure Profile		591
Add	Adds IGMP filter profile; and sets access mode	591
Show	Shows configured IGMP filter profiles	591
Add Multicast Group Range	Assigns multicast groups to selected profile	591
Show Multicast Group Range	Shows multicast groups assigned to a profile	591
Configure Interface	Assigns IGMP filter profiles to port interfaces and sets throttling action	593
Statistics		586
Show Query Statistics	Shows statistics for query-related messages	586
Show VLAN Statistics	Shows statistics for protocol messages, number of active groups	586
Show Port Statistics	Shows statistics for protocol messages, number of active groups	586

Table 6: Switch Main Menu (Continued)

Menu	Description	Page
Show Trunk Statistics	Shows statistics for protocol messages, number of active groups	586
MLD Snooping		595
General	Enables multicast filtering; configures parameters for IPv6 multicast snooping	595
Interface	Configures Immediate Leave status for a VLAN	597
Multicast Router		598
Add Static Multicast Router	Assigns ports that are attached to a neighboring multicast router	598
Show Static Multicast Router	Displays ports statically configured as attached to a neighboring multicast router	598
Show Current Multicast Router	Displays ports attached to a neighboring multicast router, either through static or dynamic configuration	598
MLD Member		600
Add Static Member	Statically assigns multicast addresses to the selected VLAN	600
Show Static Member	Shows multicast addresses statically configured on the selected VLAN	600
Show Current Member	Shows multicast addresses associated with the selected VLAN, either through static or dynamic configuration	600
Group Information	Displays known multicast groups, member ports, the means by which each group was learned, and the corresponding source list	602
MVR	Multicast VLAN Registration	603
Configure Global	Configures proxy switching and robustness value	605
Configure Domain	Enables MVR for a domain, sets the MVR VLAN, forwarding priority, and upstream source IP	607
Configure Profile		608
Add	Configures multicast stream addresses	608
Show	Shows multicast stream addresses	608
Associate Profile		608
Add	Maps an address profile to a domain	608
Show	Shows addresses profile to domain mapping	608
Configure Interface	Configures MVR interface type and immediate leave mode; also displays MVR operational and active status	611
Configure Static Group Member		614
Add	Statically assigns MVR multicast streams to an interface	614
Show	Shows MVR multicast streams assigned to an interface	614
Show Member	Shows the interfaces associated with multicast groups assigned to the MVR VLAN	616
Show Statistics		617
Show Query Statistics	Shows statistics for query-related messages	617
Show VLAN Statistics	Shows statistics for protocol messages and number of active groups	617
Show Port Statistics	Shows statistics for protocol messages and number of active groups	617

Table 6: Switch Main Menu (Continued)

Menu	Description	Page
Show Trunk Statistics	Shows statistics for protocol messages and number of active groups	617
MVR6	Multicast VLAN Registration for IPv6	621
Configure Global	Configures proxy switching and robustness value	622
Configure Domain	Enables MVR for a domain, sets the MVR VLAN, forwarding priority, and upstream source IP	624
Configure Profile		625
Add	Configures multicast stream addresses	625
Show	Shows multicast stream addresses	625
Associate Profile		625
Add	Maps an address profile to a domain	625
Show	Shows addresses profile to domain mapping	625
Configure Interface	Configures MVR interface type and immediate leave mode; also displays MVR operational and active status	628
Configure Port	Configures MVR attributes for a port	628
Configure Trunk	Configures MVR attributes for a trunk	628
Configure Static Group Member		630
Add	Statically assigns MVR multicast streams to an interface	630
Show	Shows MVR multicast streams assigned to an interface	630
Show Member	Shows the multicast groups assigned to an MVR VLAN, the source address of the multicast services, and the interfaces with active subscribers	632
Show Statistics		633
Show Query Statistics	Shows statistics for query-related messages	633
Show VLAN Statistics	Shows statistics for protocol messages, number of active groups	633
Show Port Statistics	Shows statistics for protocol messages, number of active groups	633
Show Trunk Statistics	Shows statistics for protocol messages, number of active groups	633

* ECS4110-28P/52P

This chapter describes the following topics:

- ◆ [Displaying System Information](#) – Provides basic system description, including contact information.
- ◆ [Displaying Hardware/Software Versions](#) – Shows the hardware version, power status, and firmware versions
- ◆ [Configuring Support for Jumbo Frames](#) – Enables support for jumbo frames.
- ◆ [Displaying Bridge Extension Capabilities](#) – Shows the bridge extension parameters.
- ◆ [Managing System Files](#) – Describes how to upgrade operating software or configuration files, and set the system start-up files.
- ◆ [Setting the System Clock](#) – Sets the current time manually or through specified NTP or SNTP servers.
- ◆ [Configuring the Console Port](#) – Sets console port connection parameters.
- ◆ [Configuring Telnet Settings](#) – Sets Telnet connection parameters.
- ◆ [Displaying CPU Utilization](#) – Displays information on CPU utilization.
- ◆ [Displaying Memory Utilization](#) – Shows memory utilization parameters.
- ◆ [Resetting the System](#) – Restarts the switch immediately, at a specified time, after a specified delay, or at a periodic interval.

DISPLAYING SYSTEM INFORMATION

Use the System > General page to identify the system by displaying information such as the device name, location and contact information.

CLI REFERENCES

- ◆ ["System Management Commands" on page 717](#)
- ◆ ["SNMP Commands" on page 793](#)

PARAMETERS

These parameters are displayed:

- ◆ **System Description** – Brief description of device type.
- ◆ **System Object ID** – MIB II object ID for switch's network management subsystem.
 - ECS4110-52T – 1.3.6.1.4.1.259.10.1.39.101
 - ECS4110-52P – 1.3.6.1.4.1.259.10.1.39.102
 - ECS4110-28T – 1.3.6.1.4.1.259.10.1.39.103
 - ECS4110-28P – 1.3.6.1.4.1.259.10.1.39.104
- ◆ **System Up Time** – Length of time the management agent has been up.
- ◆ **System Name** – Name assigned to the switch system.
- ◆ **System Location** – Specifies the system location.
- ◆ **System Contact** – Administrator responsible for the system.

WEB INTERFACE

To configure general system information:

1. Click System, General.
2. Specify the system name, location, and contact information for the system administrator.
3. Click Apply.

Figure 3: System Information

The screenshot shows a web interface for configuring system information. The title is "System > General". The configuration is as follows:

System Description	ECS4110-52T
System Object ID	1.3.6.1.4.1.259.10.1.39.101
System Up Time	0 days, 0 hours, 20 minutes, and 34.45 seconds
System Name	<input type="text"/>
System Location	<input type="text"/>
System Contact	<input type="text"/>

At the bottom right, there are two buttons: "Apply" and "Revert".

DISPLAYING HARDWARE/SOFTWARE VERSIONS

Use the System > Switch page to display hardware/firmware version numbers for the main board and management software, as well as the power status of the system.

CLI REFERENCES

- ◆ ["System Management Commands" on page 717](#)

PARAMETERS

The following parameters are displayed:

Main Board Information

- ◆ **Serial Number** – The serial number of the switch.
- ◆ **Number of Ports** – Number of built-in ports.
- ◆ **Hardware Version** – Hardware version of the main board.
- ◆ **Main Power Status** – Displays the status of the internal power supply.

Management Software Information

- ◆ **Role** – Shows that this switch is operating as Master or Slave.
- ◆ **EPLD Version** – Version number of EEPROM Programmable Logic Device.
- ◆ **Loader Version** – Version number of loader code.
- ◆ **Diagnostics Code Version** – Version of Power-On Self-Test (POST) and boot code.
- ◆ **Operation Code Version** – Version number of runtime code.
- ◆ **Thermal Detector** – The switch monitors the temperature registered by the PHY ICs. (The ECS4110-28T/P does not support this feature.)
- ◆ **Temperature** – The highest reported temperature on the board.

WEB INTERFACE

To view hardware and software version information.

1. Click System, then Switch.

Figure 4: General Switch Information

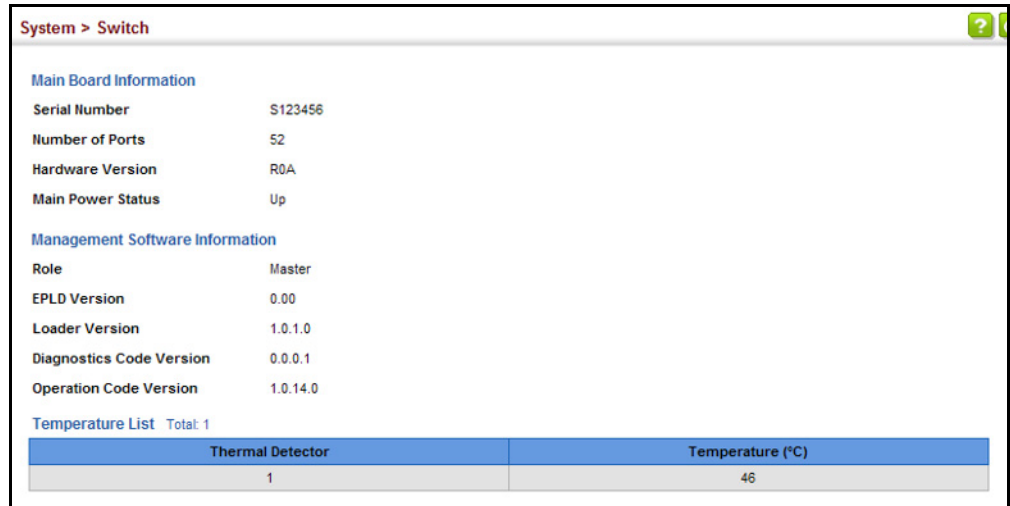

The screenshot shows a web interface for a switch. At the top, it says "System > Switch". Below this, there are two sections: "Main Board Information" and "Management Software Information".

Main Board Information

Serial Number	S123456
Number of Ports	52
Hardware Version	R0A
Main Power Status	Up

Management Software Information

Role	Master
EPLD Version	0.00
Loader Version	1.0.1.0
Diagnostics Code Version	0.0.0.1
Operation Code Version	1.0.14.0

Below the software information is a "Temperature List" with a total of 1 entry. It is presented as a table:

Thermal Detector	Temperature (°C)
1	46

CONFIGURING SUPPORT FOR JUMBO FRAMES

Use the System > Capability page to configure support for Layer 2 jumbo frames. The switch provides more efficient throughput for large sequential data transfers by supporting jumbo frames up to 10240 bytes for Gigabit Ethernet. Compared to standard Ethernet frames that run only up to 1.5 KB, using jumbo frames significantly reduces the per-packet overhead required to process protocol encapsulation fields.

CLI REFERENCES

- ◆ "System Management Commands" on page 717

USAGE GUIDELINES

To use jumbo frames, both the source and destination end nodes (such as a computer or server) must support this feature. Also, when the connection is operating at full duplex, all switches in the network between the two end nodes must be able to accept the extended frame size. And for half-duplex connections, all devices in the collision domain would need to support jumbo frames.

PARAMETERS

The following parameters are displayed:

- ◆ **Jumbo Frame** – Configures support for jumbo frames. (Default: Disabled)

WEB INTERFACE

To configure support for jumbo frames:

1. Click System, then Capability.
2. Enable or disable support for jumbo frames.
3. Click Apply.

Figure 5: Configuring Support for Jumbo Frames

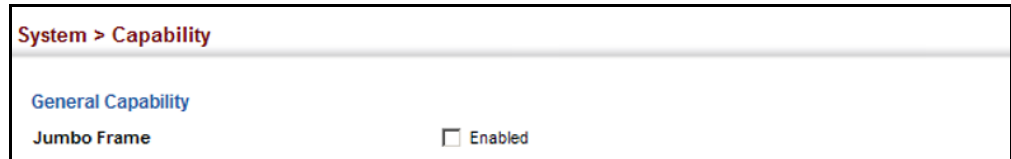

DISPLAYING BRIDGE EXTENSION CAPABILITIES

Use the System > Capability page to display settings based on the Bridge MIB. The Bridge MIB includes extensions for managed devices that support Multicast Filtering, Traffic Classes, and Virtual LANs. You can access these extensions to display default settings for the key variables.

CLI REFERENCES

- ◆ ["GVRP and Bridge Extension Commands" on page 1150](#)

PARAMETERS

The following parameters are displayed:

- ◆ **Extended Multicast Filtering Services** – This switch does not support the filtering of individual multicast addresses based on GMRP (GARP Multicast Registration Protocol).
- ◆ **Traffic Classes** – This switch provides mapping of user priorities to multiple traffic classes. (Refer to ["Class of Service" on page 273.](#))
- ◆ **Static Entry Individual Port** – This switch allows static filtering for unicast and multicast addresses. (Refer to ["Setting Static Addresses" on page 233.](#))
- ◆ **VLAN Version Number** – Based on IEEE 802.1Q, "1" indicates Bridges that support only single spanning tree (SST) operation, and "2" indicates Bridges that support multiple spanning tree (MST) operation.
- ◆ **VLAN Learning** – This switch uses Independent VLAN Learning (IVL), where each port maintains its own filtering database.
- ◆ **Local VLAN Capable** – This switch does not support multiple local bridges outside of the scope of 802.1Q defined VLANs.

- ◆ **Configurable PVID Tagging** – This switch allows you to override the default Port VLAN ID (PVID used in frame tags) and egress status (VLAN-Tagged or Untagged) on each port. (Refer to "[VLAN Configuration](#)" on page 199.)
- ◆ **Max Supported VLAN Numbers** – The maximum number of VLANs supported on this switch.
- ◆ **Max Supported VLAN ID** – The maximum configurable VLAN identifier supported on this switch.
- ◆ **GMRP** – GARP Multicast Registration Protocol (GMRP) allows network devices to register end stations with multicast groups. This switch does not support GMRP; it uses the Internet Group Management Protocol (IGMP) to provide automatic multicast filtering.

WEB INTERFACE

To view Bridge Extension information:

1. Click System, then Capability.

Figure 6: Displaying Bridge Extension Configuration

The screenshot shows a web interface for configuring system capabilities. The breadcrumb navigation is "System > Capability". Under the "General Capability" section, "Jumbo Frame" is set to "Enabled". Under the "Bridge Extension" section, the following settings are displayed:

Setting	Value
Extended Multicast Filtering Services	No
Traffic Classes	Enabled
Static Entry Individual Port	Yes
VLAN Version Number	2
VLAN Learning	NL
Local VLAN Capable	No
Configurable PVID Tagging	Yes
Max Supported VLAN Numbers	4094
Max Supported VLAN ID	4094
GMRP	Disabled

At the bottom right of the configuration area, there are two buttons: "Apply" and "Revert".

MANAGING SYSTEM FILES

This section describes how to upgrade the switch operating software or configuration files, and set the system start-up files.

COPYING FILES VIA FTP/TFTP OR HTTP

Use the System > File (Copy) page to upload/download firmware or configuration settings using FTP, TFTP or HTTP. By backing up a file to an FTP/TFTP server or management station, that file can later be downloaded to the switch to restore operation. Specify the method of file transfer, along with the file type and file names as required.

You can also set the switch to use new firmware or configuration settings without overwriting the current version. Just download the file using a different name from the current version, and then set the new file as the startup file.

CLI REFERENCES

- ◆ "copy" on page 738

COMMAND USAGE

When logging into an FTP server, the interface prompts for a user name and password configured on the remote server. Note that "Anonymous" is set as the default user name.

PARAMETERS

The following parameters are displayed:

- ◆ **Copy Type** – The firmware copy operation includes these options:
 - FTP Upgrade – Copies a file from an FTP server to the switch.
 - FTP Download – Copies a file from the switch to an FTP server.
 - HTTP Upload – Copies a file from a management station to the switch.
 - HTTP Download – Copies a file from the switch to a management station
 - TFTP Upload – Copies a file from a TFTP server to the switch.
 - TFTP Download – Copies a file from the switch to a TFTP server.
- ◆ **FTP/TFTP Server IP Address** – The IP address of an FTP/TFTP server.
- ◆ **User Name** – The user name for FTP server access.
- ◆ **Password** – The password for FTP server access.
- ◆ **File Type** – Specify Operation Code or Config File.
- ◆ **File Name** – The file name should not contain slashes (\ or /), the leading letter of the file name should not be a period (.), and the maximum length for file names is 32 characters for files on the switch

or 127 characters for files on the server. (Valid characters: A-Z, a-z, 0-9, ".", "-", "_")



NOTE: Up to two copies of the system software (i.e., the runtime firmware) can be stored in the file directory on the switch.

NOTE: The maximum number of user-defined configuration files is limited only by available flash memory space.

NOTE: The file “Factory_Default_Config.cfg” can be copied to a file server or management station, but cannot be used as the destination file name on the switch.

WEB INTERFACE

To copy firmware files:

1. Click System, then File.
2. Select Copy from the Action list.
3. Select FTP Upload, HTTP Upload, or TFTP Upload as the file transfer method.
4. If FTP or TFTP Upload is used, enter the IP address of the file server.
5. If FTP Upgrade is used, enter the user name and password for your account on the FTP server.
6. Set the file type to Operation Code.
7. Enter the name of the file to download.
8. Select a file on the switch to overwrite or specify a new file name.
9. Then click Apply.

Figure 7: Copy Firmware

The screenshot shows a web interface titled "System > File". At the top, there is a dropdown menu for "Action" set to "Copy". Below this, there are several form fields:

- Copy Type:** A dropdown menu set to "TFTP Upload".
- TFTP Server IP Address:** A text input field containing "192.168.0.99".
- File Type:** A dropdown menu set to "Operation Code".
- Source File Name:** A text input field containing "ECS4110-52P_V1.0.15.0.bix".
- Destination File Name:** A section with two radio buttons. The first radio button is unselected and next to a dropdown menu containing "ECS4110-52P_V1.0.14.0.bix". The second radio button is selected and next to a text input field containing "ECS4110-52P_V1.0.15.0.bix".

At the bottom right of the form, there are two buttons: "Apply" and "Revert".

If you replaced a file currently used for startup and want to start using the new file, reboot the system via the System > Reset menu.

SAVING THE RUNNING CONFIGURATION TO A LOCAL FILE

Use the System > File (Copy) page to save the current configuration settings to a local file on the switch. The configuration settings are not automatically saved by the system for subsequent use when the switch is rebooted. You must save these settings to the current startup file, or to another file which can be subsequently set as the startup file.

CLI REFERENCES

- ◆ "copy" on page 738

PARAMETERS

The following parameters are displayed:

- ◆ **Copy Type** – The copy operation includes this option:
 - Running-Config – Copies the current configuration settings to a local file on the switch.
- ◆ **Destination File Name** – Copy to the currently designated startup file, or to a new file. The file name should not contain slashes (\ or /), the leading letter of the file name should not be a period (.), and the maximum length for file names is 32 characters for files on the switch. (Valid characters: A-Z, a-z, 0-9, ".", "-", "_")



NOTE: The maximum number of user-defined configuration files is limited only by available flash memory space.

WEB INTERFACE

To save the running configuration file:

1. Click System, then File.
2. Select Copy from the Action list.
3. Select Running-Config from the Copy Type list.
4. Select the current startup file on the switch to overwrite or specify a new file name.
5. Then click Apply.

Figure 8: Saving the Running Configuration



If you replaced a file currently used for startup and want to start using the new file, reboot the system via the System > Reset menu.

SETTING THE START-UP FILE Use the System > File (Set Start-Up) page to specify the firmware or configuration file to use for system initialization.

CLI REFERENCES

- ◆ "whichboot" on page 743
- ◆ "boot system" on page 737

WEB INTERFACE

To set a file to use for system initialization:

1. Click System, then File.
2. Select Set Start-Up from the Action list.
3. Mark the operation code or configuration file to be used at startup
4. Then click Apply.

Figure 9: Setting Start-Up Files

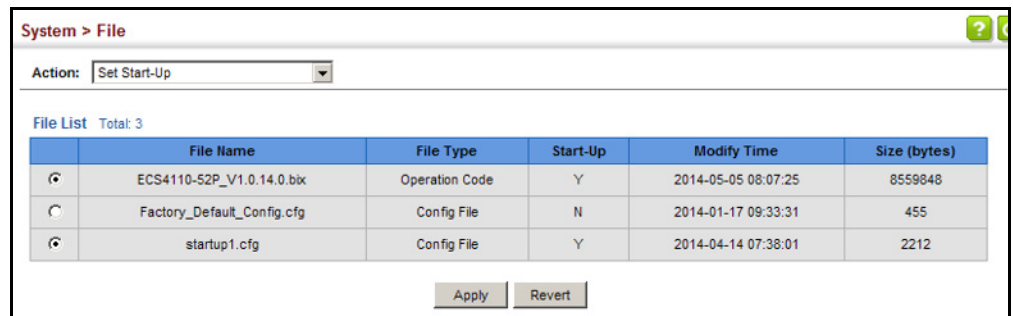

To start using the new firmware or configuration settings, reboot the system via the System > Reset menu.

SHOWING SYSTEM FILES Use the System > File (Show) page to show the files in the system directory, or to delete a file.



NOTE: Files designated for start-up, and the Factory_Default_Config.cfg file, cannot be deleted.

CLI REFERENCES

- ◆ "dir" on page 742
- ◆ "delete" on page 741

WEB INTERFACE

To show the system files:

1. Click System, then File.
2. Select Show from the Action list.
3. To delete a file, mark it in the File List and click Delete.

Figure 10: Displaying System Files

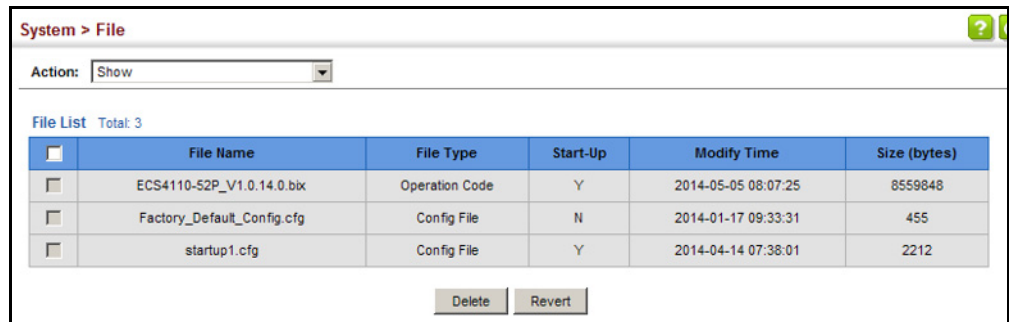

AUTOMATIC OPERATION CODE UPGRADE

Use the System > File (Automatic Operation Code Upgrade) page to automatically download an operation code file when a file newer than the currently installed one is discovered on the file server. After the file is transferred from the server and successfully written to the file system, it is automatically set as the startup file, and the switch is rebooted.

CLI REFERENCES

- ◆ "upgrade opcode auto" on page 743
- ◆ "upgrade opcode path" on page 744

USAGE GUIDELINES

- ◆ If this feature is enabled, the switch searches the defined URL once during the bootup sequence.
- ◆ FTP (port 21) and TFTP (port 69) are both supported. Note that the TCP/UDP port bindings cannot be modified to support servers listening on non-standard ports.
- ◆ The host portion of the upgrade file location URL must be a valid IPv4 IP address. DNS host names are not recognized. Valid IP addresses consist of four numbers, 0 to 255, separated by periods.
- ◆ The path to the directory must also be defined. If the file is stored in the root directory for the FTP/TFTP service, then use the "/" to indicate this (e.g., ftp://192.168.0.1/).
- ◆ The file name must not be included in the upgrade file location URL. The file name of the code stored on the remote server must be ecs4110-series.bix (using lower case letters exactly as indicated here). Enter the file name for other switches described in this manual exactly as shown on the web interface.

- ◆ The FTP connection is made with PASV mode enabled. PASV mode is needed to traverse some fire walls, even if FTP traffic is not blocked. PASV mode cannot be disabled.
- ◆ The switch-based search function is case-insensitive in that it will accept a file name in upper or lower case (i.e., the switch will accept *ECS4110-SERIES.BIX* from the server even though *ECS4110-series.bix* was requested). However, keep in mind that the file systems of many operating systems such as Unix and most Unix-like systems (FreeBSD, NetBSD, OpenBSD, and most Linux distributions, etc.) are case-sensitive, meaning that two files in the same directory, *ecs4110-series.bix* and *ECS4110-series.bix* are considered to be unique files. Thus, if the upgrade file is stored as *ECS4110-SERIES.bix* (or even *ECS4110-series.bix*) on a case-sensitive server, then the switch (requesting *ecs4110-series.bix*) will not be upgraded because the server does not recognize the requested file name and the stored file name as being equal. A notable exception in the list of case-sensitive Unix-like operating systems is Mac OS X, which by default is case-insensitive. Please check the documentation for your server's operating system if you are unsure of its file system's behavior.
- ◆ Note that the switch itself does not distinguish between upper and lower-case file names, and only checks to see if the file stored on the server is more recent than the current runtime image.
- ◆ If two operation code image files are already stored on the switch's file system, then the non-startup image is deleted before the upgrade image is transferred.
- ◆ The automatic upgrade process will take place in the background without impeding normal operations (data switching, etc.) of the switch.
- ◆ During the automatic search and transfer process, the administrator cannot transfer or update another operation code image, configuration file, public key, or HTTPS certificate (i.e., no other concurrent file management operations are possible).
- ◆ The upgrade operation code image is set as the startup image after it has been successfully written to the file system.
- ◆ The switch will send an SNMP trap and make a log entry upon all upgrade successes and failures.
- ◆ The switch will immediately restart after the upgrade file is successfully written to the file system and set as the startup image.

PARAMETERS

The following parameters are displayed:

- ◆ **Automatic Opcode Upgrade** – Enables the switch to search for an upgraded operation code file during the switch bootup process. (Default: Disabled)

- ◆ **Automatic Upgrade Location URL** – Defines where the switch should search for the operation code upgrade file. The last character of this URL must be a forward slash ("/"). The *ecs4110-series.bix* filename must not be included since it is automatically appended by the switch. (Options: ftp, tftp)

The following syntax must be observed:

tftp://host[/filedir]/

- **tftp://** – Defines TFTP protocol for the server connection.
- *host* – Defines the IP address of the TFTP server. Valid IP addresses consist of four numbers, 0 to 255, separated by periods. DNS host names are not recognized.
- *filedir* – Defines the directory, relative to the TFTP server root, where the upgrade file can be found. Nested directory structures are accepted. The directory name must be separated from the host, and in nested directory structures, from the parent directory, with a prepended forward slash "/".
- **/** – The forward slash must be the last character of the URL.

ftp://[username[:password@]]host[/filedir]/

- **ftp://** – Defines FTP protocol for the server connection.
- *username* – Defines the user name for the FTP connection. If the user name is omitted, then "anonymous" is the assumed user name for the connection.
- *password* – Defines the password for the FTP connection. To differentiate the password from the user name and host portions of the URL, a colon (:) must precede the password, and an "at" symbol (@), must follow the password. If the password is omitted, then "" (an empty string) is the assumed password for the connection.
- *host* – Defines the IP address of the FTP server. Valid IP addresses consist of four numbers, 0 to 255, separated by periods. DNS host names are not recognized.
- *filedir* – Defines the directory, relative to the FTP server root, where the upgrade file can be found. Nested directory structures are accepted. The directory name must be separated from the host, and in nested directory structures, from the parent directory, with a prepended forward slash "/".
- **/** – The forward slash must be the last character of the URL.

Examples

The following examples demonstrate the URL syntax for a TFTP server at IP address 192.168.0.1 with the operation code image stored in various locations:

- tftp://192.168.0.1/

The image file is in the TFTP root directory.

- `tftp://192.168.0.1/switch-opcode/`
The image file is in the “switch-opcode” directory, relative to the TFTP root.
- `tftp://192.168.0.1/switches/opcode/`
The image file is in the “opcode” directory, which is within the “switches” parent directory, relative to the TFTP root.

The following examples demonstrate the URL syntax for an FTP server at IP address 192.168.0.1 with various user name, password and file location options presented:

- `ftp://192.168.0.1/`
The user name and password are empty, so “anonymous” will be the user name and the password will be blank. The image file is in the FTP root directory.
- `ftp://switches:upgrade@192.168.0.1/`
The user name is “switches” and the password is “upgrade”. The image file is in the FTP root.
- `ftp://switches:upgrade@192.168.0.1/switches/opcode/`
The user name is “switches” and the password is “upgrade”. The image file is in the “opcode” directory, which is within the “switches” parent directory, relative to the FTP root.

WEB INTERFACE

To configure automatic code upgrade:

1. Click System, then File.
2. Select Automatic Operation Code Upgrade from the Action list.
3. Mark the check box to enable Automatic Opcode Upgrade.
4. Enter the URL of the FTP or TFTP server, and the path and directory containing the operation code.
5. Click Apply.

Figure 11: Configuring Automatic Code Upgrade

The screenshot shows a web interface for configuring automatic code upgrade. The breadcrumb path is "System > File". The "Action" dropdown menu is set to "Automatic Operation Code Upgrade". Below this, there is a section for "Automatic Opcode Upgrade" with a checkbox labeled "Enabled" that is currently unchecked. Underneath is a text input field for "Automatic Upgrade Location URL". A note at the bottom states: "Note: For automatic upgrades, the operation code file name must be set as ecs4110-series.bix." At the bottom right, there are two buttons: "Apply" and "Revert".

If a new image is found at the specified location, the following type of messages will be displayed during bootup.

```
:\n:\nAutomatic Upgrade is looking for a new image\nNew image detected: current version 1.0.1.5; new version 1.1.2.0\nImage upgrade in progress\nThe switch will restart after upgrade succeeds\nDownloading new image\nFlash programming started\nFlash programming completed\nThe switch will now restart\n:\n:\n
```

SETTING THE SYSTEM CLOCK

Simple Network Time Protocol (SNTP) allows the switch to set its internal clock based on periodic updates from a time server (SNTP or NTP). Maintaining an accurate time on the switch enables the system log to record meaningful dates and times for event entries. You can also manually set the clock. If the clock is not set manually or via SNTP, the switch will only record the time from the factory default set at the last bootup.

When the SNTP client is enabled, the switch periodically sends a request for a time update to a configured time server. You can configure up to three time server IP addresses. The switch will attempt to poll each server in the configured sequence.

SETTING THE TIME MANUALLY Use the System > Time (Configure General - Manual) page to set the system time on the switch manually without using SNTP.

CLI REFERENCES

- ◆ ["calendar set" on page 781](#)
- ◆ ["show calendar" on page 782](#)

PARAMETERS

The following parameters are displayed:

- ◆ **Current Time** – Shows the current time set on the switch.
- ◆ **Hours** – Sets the hour. (Range: 0-23)
- ◆ **Minutes** – Sets the minute value. (Range: 0-59)
- ◆ **Seconds** – Sets the second value. (Range: 0-59)
- ◆ **Month** – Sets the month. (Range: 1-12)

- ◆ **Day** – Sets the day of the month. (Range: 1-31)
- ◆ **Year** – Sets the year. (Range: 1970-2037)

WEB INTERFACE

To manually set the system clock:

1. Click System, then Time.
2. Select Configure General from the Step list.
3. Select Manual from the Maintain Type list.
4. Enter the time and date in the appropriate fields.
5. Click Apply

Figure 12: Manually Setting the System Clock

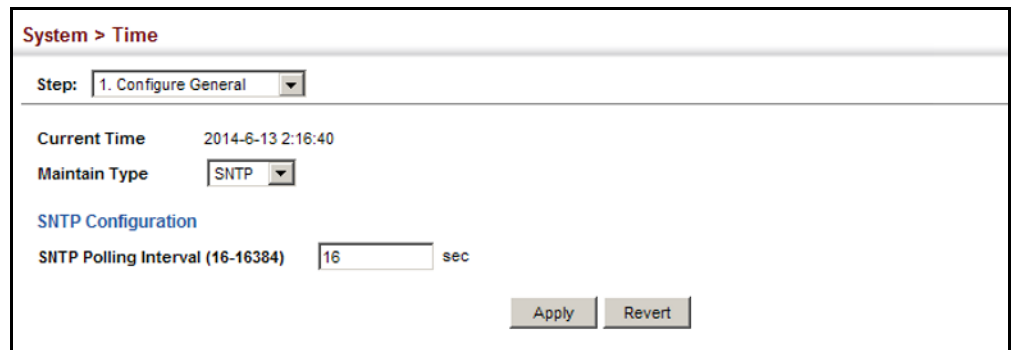

The screenshot shows the 'System > Time' configuration page. At the top, there is a breadcrumb 'System > Time' and a 'Step:' dropdown menu set to '1. Configure General'. Below this, the 'Current Time' is displayed as '2014-6-13 2:16:40'. The 'Maintain Type' is set to 'SNTP' via a dropdown menu. Under the 'SNTP Configuration' section, the 'SNTP Polling Interval (16-16384)' is set to '16' seconds. At the bottom right, there are 'Apply' and 'Revert' buttons.

SETTING THE SNTP POLLING INTERVAL

Use the System > Time (Configure General - SNTP) page to set the polling interval at which the switch will query the specified time servers.

CLI REFERENCES

- ◆ ["Time" on page 769](#)

PARAMETERS

The following parameters are displayed:

- ◆ **Current Time** – Shows the current time set on the switch.
- ◆ **SNTP Polling Interval** – Sets the interval between sending requests for a time update from a time server. (Range: 16-16384 seconds; Default: 16 seconds)

WEB INTERFACE

To set the polling interval for SNTP:

1. Click System, then Time.
2. Select Configure General from the Step list.

3. Select SNTP from the Maintain Type list.
4. Modify the polling interval if required.
5. Click Apply

Figure 13: Setting the Polling Interval for SNTP

The screenshot shows the 'System > Time' configuration page. At the top, there is a breadcrumb 'System > Time' and a 'Step: 1. Configure General' dropdown. Below this, the 'Current Time' is displayed as '2014-6-13 2:16:40'. The 'Maintain Type' is set to 'SNTP' in a dropdown menu. Under the 'SNTP Configuration' section, the 'SNTP Polling Interval (16-16384)' is set to '16' seconds. At the bottom right, there are 'Apply' and 'Revert' buttons.

CONFIGURING NTP Use the System > Time (Configure General - NTP) page to configure NTP authentication and show the polling interval at which the switch will query the specified time servers.

CLI REFERENCES

- ◆ ["Time" on page 769](#)

PARAMETERS

The following parameters are displayed:

- ◆ **Current Time** – Shows the current time set on the switch.
- ◆ **Authentication Status** – Enables authentication for time requests and updates between the switch and NTP servers. (Default: Disabled)
You can enable NTP authentication to ensure that reliable updates are received from only authorized NTP servers. The authentication keys and their associated key number must be centrally managed and manually distributed to NTP servers and clients. The key numbers and key values must match on both the server and client.
- ◆ **Polling Interval** – Shows the interval between sending requests for a time update from NTP servers. (Fixed: 1024 seconds)

WEB INTERFACE

To set the clock maintenance type to NTP:

1. Click System, then Time.
2. Select Configure General from the Step list.
3. Select NTP from the Maintain Type list.

4. Enable authentication if required.
5. Click Apply

Figure 14: Configuring NTP

The screenshot shows a web interface for configuring NTP. At the top, it says "System > Time". Below that, there is a "Step:" dropdown menu set to "1. Configure General". The "Current Time" is displayed as "2014-6-13 2:16:40". The "Maintain Type" is set to "NTP" in a dropdown menu. Under the "NTP Configuration" section, there is a checkbox for "Authentication Status" which is currently unchecked, and a "Polling Interval" set to "1024 sec". At the bottom right, there are "Apply" and "Revert" buttons.

CONFIGURING TIME SERVERS Use the System > Time (Configure Time Server) pages to specify the IP address for NTP/SNTP time servers, or to set the authentication key for NTP time servers.

SPECIFYING SNTP TIME SERVERS

Use the System > Time (Configure Time Server – Configure SNTP Server) page to specify the IP address for up to three SNTP time servers.

CLI REFERENCES

- ◆ ["sntp server" on page 772](#)

PARAMETERS

The following parameters are displayed:

- ◆ **SNTP Server IP Address** – Sets the IPv4 or IPv6 address for up to three time servers. The switch attempts to update the time from the first server, if this fails it attempts an update from the next server in the sequence.

WEB INTERFACE

To set the SNTP time servers:

1. Click System, then Time.
2. Select Configure Time Server from the Step list.
3. Select Configure SNTP Server from the Action list.
4. Enter the IP address of up to three time servers.
5. Click Apply.

Figure 15: Specifying SNTP Time Servers

The screenshot shows the 'System > Time' configuration page. At the top, there is a breadcrumb 'System > Time'. Below it, there are two dropdown menus: 'Step: 2. Configure Time Server' and 'Action: Configure SNTP Server'. The main area contains three input fields for SNTP Server IP addresses: 'SNTP Server IP Address 1' with the value '10.1.0.19', 'SNTP Server IP Address 2' with the value '137.62.140.80', and 'SNTP Server IP Address 3' with the value '128.250.36.2'. At the bottom right, there are two buttons: 'Apply' and 'Revert'.

SPECIFYING NTP TIME SERVERS

Use the System > Time (Configure Time Server – Add NTP Server) page to add the IP address for up to 50 NTP time servers.

CLI REFERENCES

- ◆ ["ntp server" on page 775](#)

PARAMETERS

The following parameters are displayed:

- ◆ **NTP Server IP Address** – Adds the IPv4 or IPv6 address for up to 50 time servers. The switch will poll the specified time servers for updates when the clock maintenance type is set to NTP on the System > Time (Configure General) page. It issues time synchronization requests at a fixed interval of 1024 seconds. The switch will poll all the time servers configured, the responses received are filtered and compared to determine the most reliable and accurate time update for the switch.
- ◆ **Version** – Specifies the NTP version supported by the server.
(Fixed: Version 3)
- ◆ **Authentication Key** – Specifies the number of the key in the NTP Authentication Key List to use for authentication with the configured server. NTP authentication is optional. If enabled on the System > Time (Configure General) page, you must also configure at least one key on the System > Time (Add NTP Authentication Key) page.
(Range: 1-65535)

WEB INTERFACE

To add an NTP time server to the server list:

1. Click System, then Time.
2. Select Configure Time Server from the Step list.
3. Select Add NTP Server from the Action list.
4. Enter the IP address of an NTP time server, and specify the index of the authentication key if authentication is required.
5. Click Apply.

Figure 16: Adding an NTP Time Servers

System > Time

Step: 2. Configure Time Server Action: Add NTP Server

NTP Server IP Address: 192.168.3.20

Version: 3

Authentication Key (1-65535): 3 (optional)

Apply Revert

To show the list of configured NTP time servers:

1. Click System, then Time.
2. Select Configure Time Server from the Step list.
3. Select Show NTP Server from the Action list.

Figure 17: Showing the NTP Time Server List

System > Time

Step: 2. Configure Time Server Action: Show NTP Server

NTP Server List Total: 1

<input type="checkbox"/>	Server IP Address	Version	Authentication Key
<input type="checkbox"/>	192.168.3.20	3	3

Delete Revert

SPECIFYING NTP AUTHENTICATION KEYS

Use the System > Time (Configure Time Server – Add NTP Authentication Key) page to add an entry to the authentication key list.

CLI REFERENCES

- ◆ ["ntp authentication-key" on page 774](#)

PARAMETERS

The following parameters are displayed:

- ◆ **Authentication Key** – Specifies the number of the key in the NTP Authentication Key List to use for authentication with a configured server. NTP authentication is optional. When enabled on the System > Time (Configure General) page, you must also configure at least one key on this page. Up to 255 keys can be configured on the switch. (Range: 1-65535)
- ◆ **Key Context** – An MD5 authentication key string. The key string can be up to 32 case-sensitive printable ASCII characters (no spaces).
NTP authentication key numbers and values must match on both the server and client.

WEB INTERFACE

To add an entry to NTP authentication key list:

1. Click System, then Time.
2. Select Configure Time Server from the Step list.
3. Select Add NTP Authentication Key from the Action list.
4. Enter the index number and MD5 authentication key string.
5. Click Apply.

Figure 18: Adding an NTP Authentication Key

To show the list of configured NTP authentication keys:

1. Click System, then Time.
2. Select Configure Time Server from the Step list.
3. Select Show NTP Authentication Key from the Action list.

Figure 19: Showing the NTP Authentication Key List

Authentication Key	Key Context
3	\$J0774Q6699747D10867F12S505J62770084708278G1357878N8475052113Q69137L8

SETTING THE TIME ZONE Use the System > Time (Configure Time Server) page to set the time zone. SNTP uses Coordinated Universal Time (or UTC, formerly Greenwich Mean Time, or GMT) based on the time at the Earth's prime meridian, zero degrees longitude, which passes through Greenwich, England. To display a time corresponding to your local time, you must indicate the number of hours and minutes your time zone is east (before) or west (after) of UTC. You can choose one of the 80 predefined time zone definitions, or you can manually configure the parameters for your local time zone.

CLI REFERENCES

- ◆ "clock timezone" on page 780

PARAMETERS

The following parameters are displayed:

- ◆ **Name** – Assigns a name to the time zone. (Range: 1-30 characters)
- ◆ **Hours (-12 – 13)** – The number of hours before/after UTC. The maximum value before UTC is 12. The maximum value after UTC is 13.
- ◆ **Minutes (0-59)** – The number of minutes before/after UTC.

WEB INTERFACE

To set your local time zone:

1. Click System, then Time.
2. Select Configure Time Zone from the Step list.
3. Set the offset for your time zone relative to the UTC in hours and minutes.
4. Click Apply.

Figure 20: Setting the Time Zone

The screenshot shows a web interface for configuring the system time zone. At the top, it says "System > Time". Below that, there is a "Step:" dropdown menu currently set to "3. Configure Time Zone". The main configuration area contains three input fields: "Name" with the value "UTC", "Hours (-12-13)" with the value "0", and "Minutes (0-59)" with the value "0". At the bottom right of the form, there are two buttons: "Apply" and "Revert".

CONFIGURING THE CONSOLE PORT

Use the System > Console menu to configure connection parameters for the switch's console port. You can access the onboard configuration program by attaching a VT100 compatible device to the switch's serial console port. Management access through the console port is controlled by various parameters, including a password (only configurable through the CLI), time outs, and basic communication settings. Note that these parameters can be configured via the web or CLI interface.

CLI REFERENCES

- ◆ ["Line" on page 748](#)

PARAMETERS

The following parameters are displayed:

- ◆ **Login Timeout** – Sets the interval that the system waits for a user to log into the CLI. If a login attempt is not detected within the timeout interval, the connection is terminated for the session. (Range: 10-300 seconds; Default: 300 seconds)
- ◆ **Exec Timeout** – Sets the interval that the system waits until user input is detected. If user input is not detected within the timeout interval, the current session is terminated. (Range: 60-65535 seconds; Default: 600 seconds)
- ◆ **Password Threshold** – Sets the password intrusion threshold, which limits the number of failed logon attempts. When the logon attempt threshold is reached, the system interface becomes silent for a specified amount of time (set by the Silent Time parameter) before allowing the next logon attempt. (Range: 1-120; Default: 3 attempts)
- ◆ **Silent Time** – Sets the amount of time the management console is inaccessible after the number of unsuccessful logon attempts has been exceeded. (Range: 1-65535 seconds; Default: Disabled)
- ◆ **Data Bits** – Sets the number of data bits per character that are interpreted and generated by the console port. If parity is being generated, specify 7 data bits per character. If no parity is required, specify 8 data bits per character. (Default: 8 bits)
- ◆ **Stop Bits** – Sets the number of the stop bits transmitted per byte. (Range: 1-2; Default: 1 stop bit)
- ◆ **Parity** – Defines the generation of a parity bit. Communication protocols provided by some terminals can require a specific parity bit setting. Specify Even, Odd, or None. (Default: None)
- ◆ **Speed** – Sets the terminal line's baud rate for transmit (to terminal) and receive (from terminal). Set the speed to match the baud rate of the device connected to the serial port. (Range: 9600, 19200, 38400, 57600 or 115200 baud; Default: 115200 baud)



NOTE: The password for the console connection can only be configured through the CLI (see "password" on page 752).

NOTE: Password checking can be enabled or disabled for logging in to the console connection (see "login" on page 751). You can select authentication by a single global password as configured for the password command, or by passwords set up for specific user-name accounts. The default is for local passwords configured on the switch.

WEB INTERFACE

To configure parameters for the console port:

1. Click System, then Console.
2. Specify the connection parameters as required.
3. Click Apply

Figure 21: Console Port Settings

The screenshot shows the 'System > Console' configuration page. It contains the following settings:

Login Timeout (10-300)	<input type="text" value="300"/> sec
Exec Timeout (60-65535)	<input checked="" type="checkbox"/> <input type="text" value="600"/> sec
Password Threshold (1-120)	<input checked="" type="checkbox"/> <input type="text" value="3"/>
Silent Time (1-65535)	<input type="checkbox"/> <input type="text"/> sec
Data Bits	<input type="text" value="8"/>
Stop Bits	<input type="text" value="1"/>
Parity	<input type="text" value="None"/>
Speed	<input type="text" value="115200"/> baud

At the bottom right, there are two buttons: 'Apply' and 'Revert'.

CONFIGURING TELNET SETTINGS

Use the System > Telnet menu to configure parameters for accessing the CLI over a Telnet connection. You can access the onboard configuration program over the network using Telnet (i.e., a virtual terminal). Management access via Telnet can be enabled/disabled and other parameters set, including the TCP port number, time outs, and a password. Note that the password is only configurable through the CLI.) These parameters can be configured via the web or CLI interface.

CLI REFERENCES

- ◆ "Line" on page 748
- ◆ "Telnet Server" on page 850

PARAMETERS

The following parameters are displayed:

- ◆ **Telnet Status** – Enables or disables Telnet access to the switch. (Default: Enabled)
- ◆ **TCP Port** – Sets the TCP port number for Telnet on the switch. (Range: 1-65535; Default: 23)
- ◆ **Max Sessions** – Sets the maximum number of Telnet sessions that can simultaneously connect to this system. (Range: 0-8; Default: 8)
A maximum of eight sessions can be concurrently opened for Telnet and Secure Shell (i.e., both Telnet and SSH share a maximum number or eight sessions).
- ◆ **Login Timeout** – Sets the interval that the system waits for a user to log into the CLI. If a login attempt is not detected within the timeout interval, the connection is terminated for the session. (Range: 10-300 seconds; Default: 300 seconds)
- ◆ **Exec Timeout** – Sets the interval that the system waits until user input is detected. If user input is not detected within the timeout interval, the current session is terminated. (Range: 60-65535 seconds; Default: 600 seconds)
- ◆ **Password Threshold** – Sets the password intrusion threshold, which limits the number of failed logon attempts. When the logon attempt threshold is reached, the system interface becomes silent for a specified amount of time (set by the Silent Time parameter) before allowing the next logon attempt. (Range: 1-120; Default: 3 attempts)
- ◆ **Silent Time** – Sets the amount of time the management interface is inaccessible after the number of unsuccessful logon attempts has been exceeded. (Range: 1-65535 seconds; Default: Disabled)



NOTE: Password checking can be enabled or disabled for login to the console connection (see "[login](#)" on page 751). You can select authentication by a single global password as configured for the password command, or by passwords set up for specific user-name accounts. The default is for local passwords configured on the switch.

WEB INTERFACE

To configure parameters for the console port:

1. Click System, then Telnet.
2. Specify the connection parameters as required.
3. Click Apply

Figure 22: Telnet Connection Settings

The screenshot shows the 'System > Telnet' configuration page. It includes the following settings:

Parameter	Value
Telnet Status	<input checked="" type="checkbox"/> Enabled
TCP Port (1-65535)	23
Max Sessions (0-8)	8
Login Timeout (10-300)	300 sec
Exec Timeout (60-65535)	600 sec
Password Threshold (1-120)	<input checked="" type="checkbox"/> 3
Silent Time (1-65535)	<input type="checkbox"/> [] sec

Buttons: Apply, Revert

DISPLAYING CPU UTILIZATION

Use the System > CPU Utilization page to display information on CPU utilization.

CLI REFERENCES

- ◆ ["show process cpu" on page 729](#)

PARAMETERS

The following parameters are displayed:

- ◆ **Time Interval** – The interval at which to update the displayed utilization rate. (Options: 1, 5, 10, 30, 60 seconds; Default: 1 second)
- ◆ **CPU Utilization** – CPU utilization over specified interval.

WEB INTERFACE

To display CPU utilization:

1. Click System, then CPU Utilization.
2. Change the update interval if required. Note that the interval is changed as soon as a new setting is selected.

Figure 23: Displaying CPU Utilization

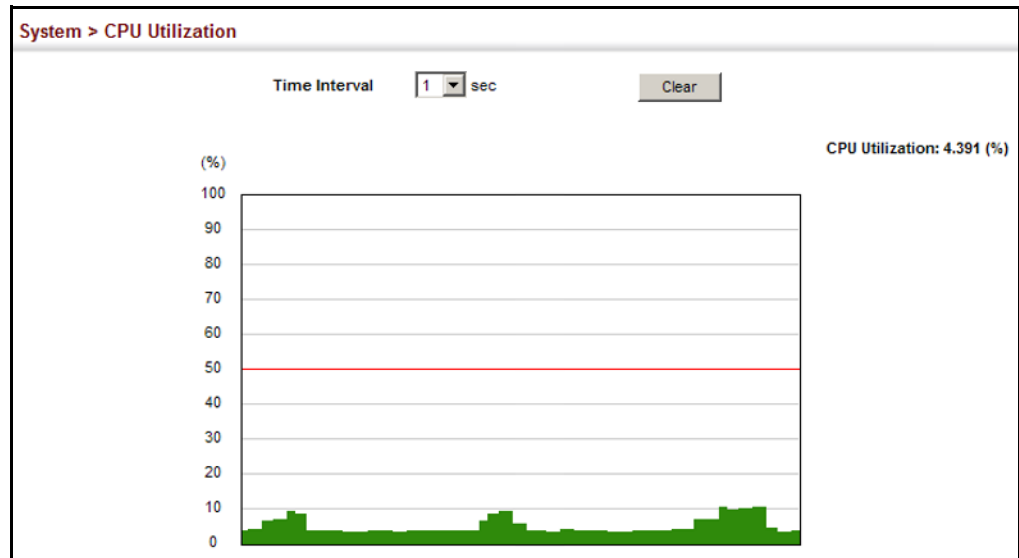

DISPLAYING MEMORY UTILIZATION

Use the System > Memory Status page to display memory utilization parameters.

CLI REFERENCES

- ◆ ["show memory" on page 728](#)

PARAMETERS

The following parameters are displayed:

- ◆ **Free Size** – The amount of memory currently free for use.
- ◆ **Used Size** – The amount of memory allocated to active processes.
- ◆ **Total** – The total amount of system memory.

WEB INTERFACE

To display memory utilization:

1. Click System, then Memory Status.

Figure 24: Displaying Memory Utilization

System > Memory Status	
Memory Status	
Free Size	42,201,088 bytes
Used Size	92,016,640 bytes
Total	134,217,728 bytes

RESETTING THE SYSTEM

Use the System > Reset menu to restart the switch immediately, at a specified time, after a specified delay, or at a periodic interval.

CLI REFERENCES

- ◆ "reload (Privileged Exec)" on page 714
- ◆ "reload (Global Configuration)" on page 710
- ◆ "show reload" on page 715

COMMAND USAGE

- ◆ This command resets the entire system.
- ◆ When the system is restarted, it will always run the Power-On Self-Test. It will also retain all configuration information stored in non-volatile memory by the [copy running-config startup-config](#) command (see ["copy" on page 738](#)).

PARAMETERS

The following parameters are displayed:

System Reload Information

- ◆ **Reload Settings** – Displays information on the next scheduled reload and selected reload mode as shown in the following example:
"The switch will be rebooted at March 9 12:00:00 2012. Remaining Time: 0 days, 2 hours, 46 minutes, 5 seconds.
Reloading switch regularly time: 12:00 everyday."
- ◆ **Refresh** – Refreshes reload information. Changes made through the console or to system time may need to be refreshed to display the current settings.
- ◆ **Cancel** – Cancels the current settings shown in this field.

System Reload Configuration

- ◆ **Reset Mode** – Restarts the switch immediately or at the specified time(s).
 - **Immediately** – Restarts the system immediately.
 - **In** – Specifies an interval after which to reload the switch. (The specified time must be equal to or less than 24 days.)
 - *hours* – The number of hours, combined with the minutes, before the switch resets. (Range: 0-576)
 - *minutes* – The number of minutes, combined with the hours, before the switch resets. (Range: 0-59)

- **At** – Specifies a time at which to reload the switch.
 - DD - The day of the month at which to reload. (Range: 01-31)
 - MM - The month at which to reload. (Range: 01-12)
 - YYYY - The year at which to reload. (Range: 1970-2037)
 - HH - The hour at which to reload. (Range: 00-23)
 - MM - The minute at which to reload. (Range: 00-59)
- **Regularly** – Specifies a periodic interval at which to reload the switch.

Time

- HH - The hour at which to reload. (Range: 00-23)
- MM - The minute at which to reload. (Range: 00-59)

Period

- Daily - Every day.
- Weekly - Day of the week at which to reload. (Range: Sunday ... Saturday)
- Monthly - Day of the month at which to reload. (Range: 1-31)

WEB INTERFACE

To restart the switch:

1. Click System, then Reset.
2. Select the required reset mode.
3. For any option other than to reset immediately, fill in the required parameters
4. Click Apply.
5. When prompted, confirm that you want reset the switch.

Figure 25: Restarting the Switch (Immediately)

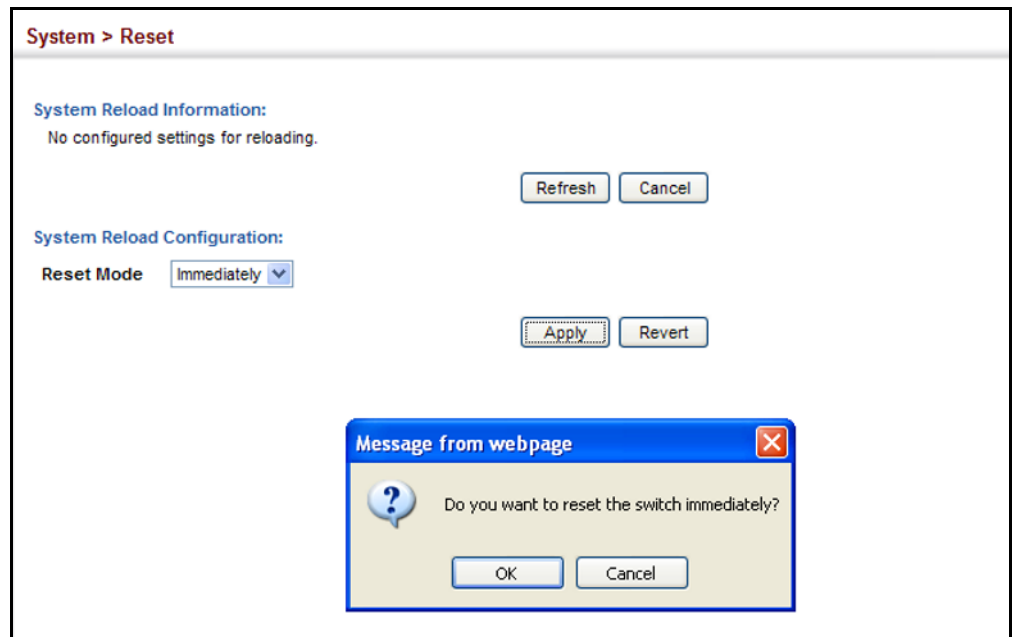

Figure 26: Restarting the Switch (In)

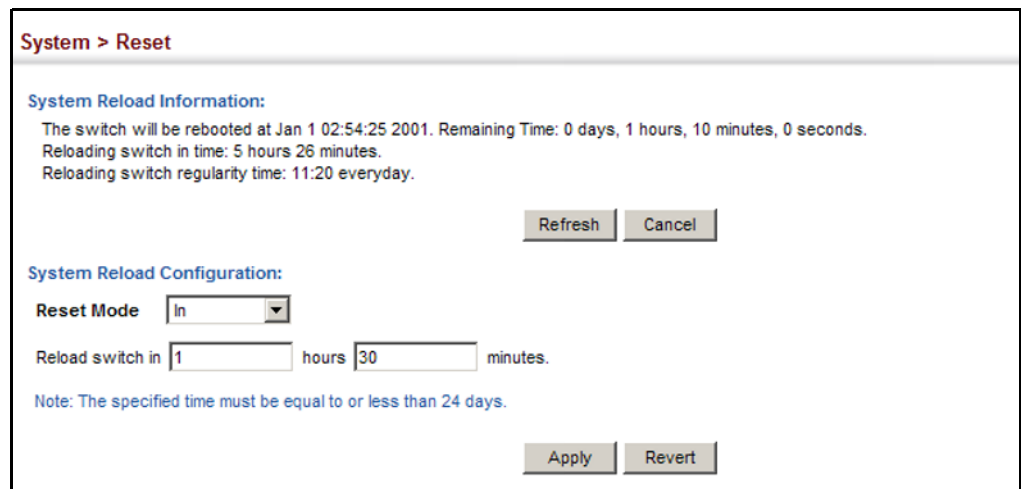

Figure 27: Restarting the Switch (At)

System > Reset

System Reload Information:
The switch will be rebooted at Jan 1 02:54:25 2001. Remaining Time: 0 days, 1 hours, 10 minutes, 0 seconds.
Reloading switch in time: 5 hours 26 minutes.
Reloading switch regularity time: 11:20 everyday.

System Reload Configuration:
Reset Mode
Reload switch at (DD/MM/YYYY) (HH:MM)
Warning: You have to setup system time first.Otherwise this function won't work.

Figure 28: Restarting the Switch (Regularly)

System > Reset

System Reload Information:
No configured settings for reloading.

System Reload Configuration:
Reset Mode
Time (HH:MM)
Period Daily
 Weekly
 Monthly

Warning: You have to setup system time first.Otherwise this function won't work.

This chapter describes the following topics:

- ◆ [Port Configuration](#) – Configures connection settings, including auto-negotiation, or manual setting of speed, duplex mode, and flow control.
- ◆ [Local Port Mirroring](#) – Sets the source and target ports for mirroring on the local switch.
- ◆ [Remote Port Mirroring](#) – Configures mirroring of traffic from remote switches for analysis at a destination port on the local switch.
- ◆ [Displaying Statistics](#) – Shows Interface, Etherlike, and RMON port statistics in table or chart form.
- ◆ [Displaying Transceiver Data](#) – Displays identifying information, and operational parameters for optical transceivers which support DDM.
- ◆ [Configuring Transceiver Thresholds](#) – Configures thresholds for alarm and warning messages for optical transceivers which support DDM.
- ◆ [Cable Test](#) – Tests the cable attached to a port.
- ◆ [Trunk Configuration](#) – Configures static or dynamic trunks.
- ◆ [Saving Power](#) – Adjusts the power provided to ports based on the length of the cable used to connect to other devices.
- ◆ [Traffic Segmentation](#) – Configures the uplinks and down links to a segmented group of ports.
- ◆ [VLAN Trunking](#) – Configures a tunnel across one or more intermediate switches which pass traffic for VLAN groups to which they do not belong.

PORT CONFIGURATION

This section describes how to configure port connections, mirror traffic from one port to another, and run cable diagnostics.

CONFIGURING BY PORT LIST Use the Interface > Port > General (Configure by Port List) page to enable/disable an interface, set auto-negotiation and the interface capabilities to advertise, or manually fix the speed, duplex mode, and flow control.

CLI REFERENCES

- ◆ ["Interface Commands" on page 995](#)

COMMAND USAGE

- ◆ Auto-negotiation must be disabled before you can configure or force an RJ-45 interface to use the Speed/Duplex mode or Flow Control options.
- ◆ When using auto-negotiation, the optimal settings will be negotiated between the link partners based on their advertised capabilities. To set the speed, duplex mode, or flow control under auto-negotiation, the required operation modes must be specified in the capabilities list for an interface.
- ◆ The 1000BASE-T standard does not support forced mode. Auto-negotiation should always be used to establish a connection over any 1000BASE-T port or trunk. If not used, the success of the link process cannot be guaranteed when connecting to other types of switches.
- ◆ The Speed/Duplex mode is fixed at 1000full on the Gigabit SFP ports. When auto-negotiation is enabled, the only attribute which can be advertised is flow control.

PARAMETERS

These parameters are displayed:

- ◆ **Port** – Port identifier. (Range: 1-28/52)
- ◆ **Type** – Indicates the port type. (100BASE-FX, 1000BASE-T, 1000BASE SFP)
- ◆ **Name** – Allows you to label an interface. (Range: 1-64 characters)
- ◆ **Admin** – Allows you to manually disable an interface. You can disable an interface due to abnormal behavior (e.g., excessive collisions), and then re-enable it after the problem has been resolved. You may also disable an interface for security reasons.
- ◆ **Media Type** – Forces the operating mode to use for SFP ports 25-28/49-52.
 - **None** - Does not force the operating mode.

- **SFP-Forced 1000SFP** - Forces port to use 1000BASE SFP mode.
- **SFP-Forced 100FX** - Forces port to use 100BASE-FX mode.
- ◆ **Autonegotiation** (Port Capabilities) – Allows auto-negotiation to be enabled/disabled. When auto-negotiation is enabled, you need to specify the capabilities to be advertised. When auto-negotiation is disabled, you can force the settings for speed, mode, and flow control. The following capabilities are supported.
 - **10h** - Supports 10 Mbps half-duplex operation
 - **10f** - Supports 10 Mbps full-duplex operation
 - **100h** - Supports 100 Mbps half-duplex operation
 - **100f** - Supports 100 Mbps full-duplex operation
 - **1000f** - Supports 1000 Mbps full-duplex operation
 - **FC** - Flow control can eliminate frame loss by “blocking” traffic from end stations or segments connected directly to the switch when its buffers fill. When enabled, back pressure is used for half-duplex operation and IEEE 802.3-2005 (formally IEEE 802.3x) for full-duplex operation.

Default: Autonegotiation enabled; Advertised capabilities for
100BASE-FX (SFP) – 100full
1000BASE-T – 10half, 10full, 100half, 100full, 1000full;
1000BASE-SX/LX/LH (SFP) – 1000full
- ◆ **Speed/Duplex** – Allows you to manually set the port speed and duplex mode. (i.e., with auto-negotiation disabled)
- ◆ **Flow Control** – Allows automatic or manual selection of flow control.

WEB INTERFACE

To configure port connection parameters:

1. Click Interface, Port, General.
2. Select Configure by Port List from the Action List.
3. Modify the required interface settings.
4. Click Apply.

Figure 29: Configuring Connections by Port List

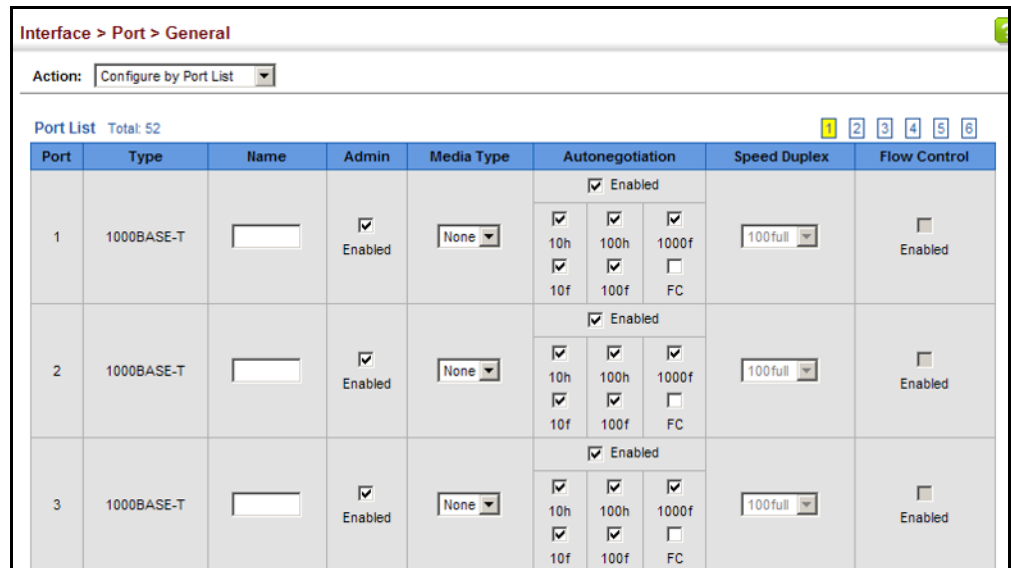

CONFIGURING BY PORT RANGE Use the Interface > Port > General (Configure by Port Range) page to enable/disable an interface, set auto-negotiation and the interface capabilities to advertise, or manually fix the speed, duplex mode, and flow control.

For more information on command usage and a description of the parameters, refer to ["Configuring by Port List" on page 156](#).

CLI REFERENCES

◆ ["Interface Commands" on page 995](#)

WEB INTERFACE

To configure port connection parameters:

1. Click Interface, Port, General.
2. Select Configure by Port Range from the Action List.
3. Enter to range of ports to which your configuration changes apply.
4. Modify the required interface settings.
5. Click Apply.

Figure 30: Configuring Connections by Port Range

Interface > Port > General

Action: Configure by Port Range

Port Range (1-52) -

Admin Enabled

Autonegotiation Enabled

10h 100h 1000f

10f 100f FC

Speed Duplex 10half

Flow Control Enabled

Apply Revert

DISPLAYING CONNECTION STATUS Use the Interface > Port > General (Show Information) page to display the current connection status, including link state, speed/duplex mode, flow control, and auto-negotiation.

CLI REFERENCES

- ◆ ["show interfaces status" on page 1007](#)

PARAMETERS

These parameters are displayed:

- ◆ **Port** – Port identifier.
- ◆ **Type** – Indicates the port type. (100BASE-FX, 1000BASE-T, 1000BASE SFP)
- ◆ **Name** – Interface label.
- ◆ **Admin** – Shows if the port is enabled or disabled.
- ◆ **Oper Status** – Indicates if the link is Up or Down.
- ◆ **Media Type** – Media type used.
- ◆ **Autonegotiation** – Shows if auto-negotiation is enabled or disabled.
- ◆ **Oper Speed Duplex** – Shows the current speed and duplex mode.
- ◆ **Oper Flow Control** – Shows the flow control type used.

WEB INTERFACE

To display port connection parameters:

1. Click Interface, Port, General.
2. Select Show Information from the Action List.

Figure 31: Displaying Port Information

Interface > Port > General

Action: Show Information

Port List Total: 52

Port	Type	Name	Admin	Oper Status	Media Type	Autonegotiation	Oper Speed Duplex	Oper Flow Control
1	1000BASE-T		Enabled	Up	None	Enabled	100full	None
2	1000BASE-T		Enabled	Down	None	Enabled	1000full	None
3	1000BASE-T		Enabled	Down	None	Enabled	1000full	None
4	1000BASE-T		Enabled	Down	None	Enabled	1000full	None
5	1000BASE-T		Enabled	Down	None	Enabled	1000full	None
6	1000BASE-T		Enabled	Down	None	Enabled	1000full	None
7	1000BASE-T		Enabled	Down	None	Enabled	1000full	None
8	1000BASE-T		Enabled	Down	None	Enabled	1000full	None
9	1000BASE-T		Enabled	Down	None	Enabled	1000full	None
10	1000BASE-T		Enabled	Down	None	Enabled	1000full	None

CONFIGURING LOCAL PORT MIRRORING

Use the Interface > Port > Mirror page to mirror traffic from any source port to a target port for real-time analysis. You can then attach a logic analyzer or RMON probe to the target port and study the traffic crossing the source port in a completely unobtrusive manner.

Figure 32: Configuring Local Port Mirroring

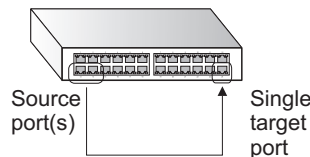

CLI REFERENCES

- ◆ "Local Port Mirroring Commands" on page 1045

COMMAND USAGE

- ◆ Traffic can be mirrored from one or more source ports to a destination port on the same switch (local port mirroring as described in this section), or from one or more source ports on remote switches to a destination port on this switch (remote port mirroring as described in "Configuring Remote Port Mirroring" on page 162).
- ◆ Monitor port speed should match or exceed source port speed, otherwise traffic may be dropped from the monitor port.
- ◆ When mirroring VLAN traffic (see "Configuring VLAN Mirroring" on page 229) or packets based on a source MAC address (see "Configuring MAC Address Mirroring" on page 237), the target port cannot be set to the same target ports as that used for port mirroring by this command.
- ◆ When traffic matches the rules for both port mirroring, and for mirroring of VLAN traffic or packets based on a MAC address, the matching packets will not be sent to target port specified for port mirroring.

- ◆ Spanning Tree BPDU packets are not mirrored to the target port.
- ◆ The destination port cannot be a trunk or trunk member port.

PARAMETERS

These parameters are displayed:

- ◆ **Source Port** – The port whose traffic will be monitored.
- ◆ **Target Port** – The port that will mirror the traffic on the source port.
- ◆ **Type** – Allows you to select which traffic to mirror to the target port, Rx (receive), Tx (transmit), or Both. (Default: Both)

WEB INTERFACE

To configure a local mirror session:

1. Click Interface, Port, Mirror.
2. Select Add from the Action List.
3. Specify the source port.
4. Specify the monitor port.
5. Specify the traffic type to be mirrored.
6. Click Apply.

Figure 33: Configuring Local Port Mirroring

The screenshot shows a web configuration page for port mirroring. At the top, the breadcrumb navigation reads "Interface > Port > Mirror". Below this, there is a section for configuring a new mirror session. The "Action" dropdown menu is set to "Add". The "Source Port" configuration includes a "Unit" dropdown set to "1" and a "Port" dropdown set to "7". The "Target Port" configuration includes a "Unit" dropdown set to "1" and a "Port" dropdown set to "8". The "Type" dropdown menu is set to "Rx". At the bottom right of the configuration area, there are two buttons: "Apply" and "Revert".

To display the configured mirror sessions:

1. Click Interface, Port, Mirror.
2. Select Show from the Action List.

Figure 34: Displaying Local Port Mirror Sessions

	Source (Unit/Port)	Target (Unit/Port)	Type
<input type="checkbox"/>	1 / 7	1 / 8	Both
<input type="checkbox"/>	1 / 9	1 / 10	Rx

**CONFIGURING
REMOTE PORT
MIRRORING**

Use the Interface > RSPAN page to mirror traffic from remote switches for analysis at a destination port on the local switch. This feature, also called Remote Switched Port Analyzer (RSPAN), carries traffic generated on the specified source ports for each session over a user-specified VLAN dedicated to that RSPAN session in all participating switches. Monitored traffic from one or more sources is copied onto the RSPAN VLAN through IEEE 802.1Q trunk or hybrid ports that carry it to any RSPAN destination port monitoring the RSPAN VLAN as shown in the figure below.

Figure 35: Configuring Remote Port Mirroring

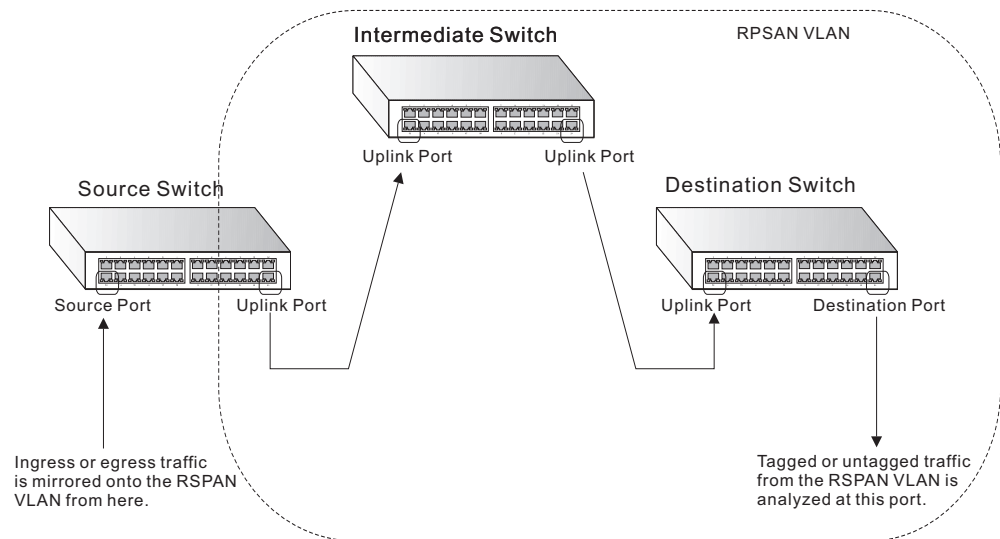

CLI REFERENCES

- ◆ "RSPAN Mirroring Commands" on page 1048

COMMAND USAGE

- ◆ Traffic can be mirrored from one or more source ports to a destination port on the same switch (local port mirroring as described in "Configuring Local Port Mirroring" on page 160), or from one or more source ports on remote switches to a destination port on this switch (remote port mirroring as described in this section).

◆ Configuration Guidelines

Take the following step to configure an RSPAN session:

1. Use the VLAN Static List (see ["Configuring VLAN Groups" on page 202](#)) to reserve a VLAN for use by RSPAN (marking the "Remote VLAN" field on this page. (Default VLAN 1 is prohibited.)
2. Set up the source switch on the RSPAN configuration page by specifying the mirror session, the switch's role (Source), the RSPAN VLAN, and the uplink port¹. Then specify the source port(s), and the traffic type to monitor (Rx, Tx or Both).
3. Set up all intermediate switches on the RSPAN configuration page, entering the mirror session, the switch's role (Intermediate), the RSPAN VLAN, and the uplink port(s).
4. Set up the destination switch on the RSPAN configuration page by specifying the mirror session, the switch's role (Destination), the destination port¹, whether or not the traffic exiting this port will be tagged or untagged, and the RSPAN VLAN. Then specify each uplink port where the mirrored traffic is being received.

◆ RSPAN Limitations

The following limitations apply to the use of RSPAN on this switch:

- *RSPAN Ports* – Only ports can be configured as an RSPAN source, destination, or uplink; static and dynamic trunks are not allowed. A port can only be configured as one type of RSPAN interface – source, destination, or uplink. Also, note that the source port and destination port cannot be configured on the same switch.
- *Local/Remote Mirror* – The destination of a local mirror session (created on the Interface > Port > Mirror page) cannot be used as the destination for RSPAN traffic.
- *Spanning Tree* – If the spanning tree is disabled, BPDUs will not be flooded onto the RSPAN VLAN.
- MAC address learning is not supported on RSPAN uplink ports when RSPAN is enabled on the switch. Therefore, even if spanning tree is enabled after RSPAN has been configured, MAC address learning will still not be re-started on the RSPAN uplink ports.
- *IEEE 802.1X* – RSPAN and 802.1X are mutually exclusive functions. When 802.1X is enabled globally, RSPAN uplink ports cannot be configured, even though RSPAN source and destination ports can still be configured. When RSPAN uplink ports are enabled on the switch, 802.1X cannot be enabled globally.

1. Only 802.1Q trunk or hybrid (i.e., general use) ports can be configured as an RSPAN uplink or destination ports – access ports are not allowed (see ["Adding Static Members to VLANs" on page 205](#)).

- *Port Security* – If port security is enabled on any port, that port cannot be set as an RSPAN uplink port, even though it can still be configured as an RSPAN source or destination port. Also, when a port is configured as an RSPAN uplink port, port security cannot be enabled on that port.

PARAMETERS

These parameters are displayed:

- ◆ **Session** – A number identifying this RSPAN session. (Range: 1)
Only one mirror session is allowed, including both local and remote mirroring. If local mirroring is enabled (see [page 160](#)), then no session is available for RSPAN.
- ◆ **Operation Status** – Indicates whether or not RSPAN is currently functioning.
- ◆ **Switch Role** – Specifies the role this switch performs in mirroring traffic.
 - **None** – This switch will not participate in RSPAN.
 - **Source** - Specifies this device as the source of remotely mirrored traffic.
 - **Intermediate** - Specifies this device as an intermediate switch, transparently passing mirrored traffic from one or more sources to one or more destinations.
 - **Destination** - Specifies this device as a switch configured with a destination port which is to receive mirrored traffic for this session.
- ◆ **Remote VLAN** – The VLAN to which traffic mirrored from the source port will be flooded. The VLAN specified in this field must first be reserved for the RSPAN application using the VLAN > Static page (see [page 202](#)).
- ◆ **Uplink Port** – A port on any switch participating in RSPAN through which mirrored traffic is passed on to or received from the RSPAN VLAN.
Only one uplink port can be configured on a source switch, but there is no limitation on the number of uplink ports¹ configured on an intermediate or destination switch.
Only destination and uplink ports will be assigned by the switch as members of the RSPAN VLAN. Ports cannot be manually assigned to an RSPAN VLAN through the VLAN > Static page. Nor can GVRP dynamically add port members to an RSPAN VLAN. Also, note that the VLAN > Static (Show) page will not display any members for an RSPAN VLAN, but will only show configured RSPAN VLAN identifiers.
- ◆ **Type** – Specifies the traffic type to be mirrored remotely. (Options: Rx, Tx, Both)

- ◆ **Destination Port** – Specifies the destination port¹ to monitor the traffic mirrored from the source ports. Only one destination port can be configured on the same switch per session, but a destination port can be configured on more than one switch for the same session. Also note that a destination port can still send and receive switched traffic, and participate in any Layer 2 protocols to which it has been assigned.
- ◆ **Tag** – Specifies whether or not the traffic exiting the destination port to the monitoring device carries the RSPAN VLAN tag.

WEB INTERFACE

To configure a remote mirror session:

1. Click Interface, RSPAN.
2. Set the Switch Role to None, Source, Intermediate, or Destination.
3. Configure the required settings for each switch participating in the RSPAN VLAN.
4. Click Apply.

Figure 36: Configuring Remote Port Mirroring (Source)

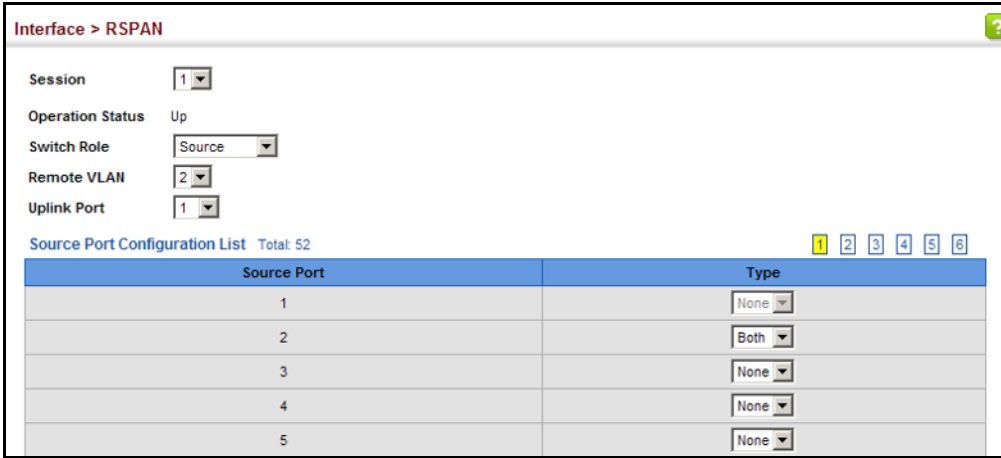

Figure 37: Configuring Remote Port Mirroring (Intermediate)

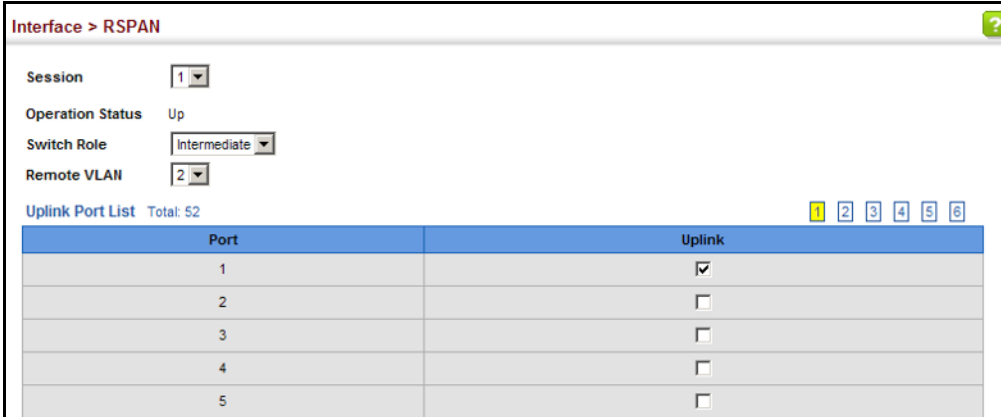
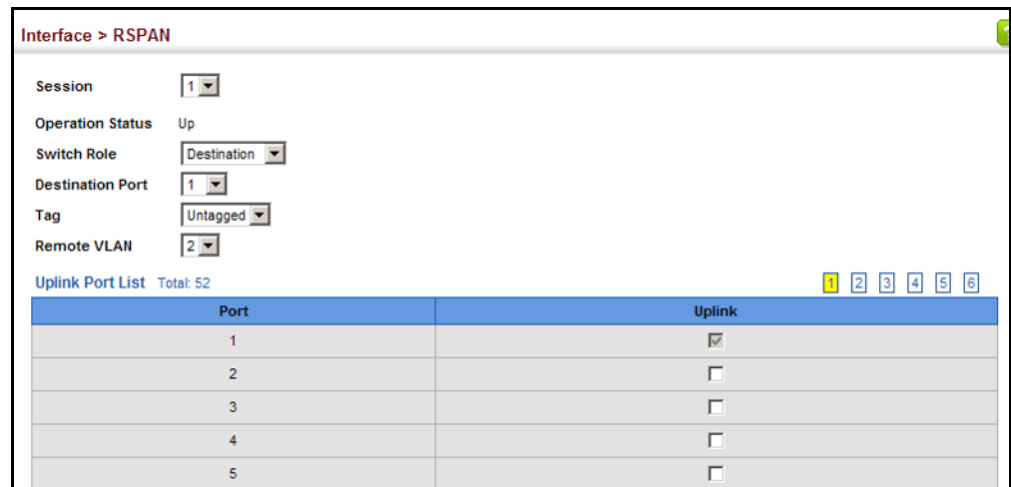

Figure 38: Configuring Remote Port Mirroring (Destination)



SHOWING PORT OR TRUNK STATISTICS

Use the Interface > Port/Trunk > Statistics or Chart page to display standard statistics on network traffic from the Interfaces Group and Ethernet-like MIBs, as well as a detailed breakdown of traffic based on the RMON MIB. Interfaces and Ethernet-like statistics display errors on the traffic passing through each port. This information can be used to identify potential problems with the switch (such as a faulty port or unusually heavy traffic). RMON statistics provide access to a broad range of statistics, including a total count of different frame types and sizes passing through each port. All values displayed have been accumulated since the last system reboot, and are shown as counts per second. Statistics are refreshed every 60 seconds by default.



NOTE: RMON groups 2, 3 and 9 can only be accessed using SNMP management software.

CLI REFERENCES

- ◆ "show interfaces counters" on page 1005

PARAMETERS

These parameters are displayed:

Table 7: Port Statistics

Parameter	Description
<i>Interface Statistics</i>	
Received Octets	The total number of octets received on the interface, including framing characters.
Transmitted Octets	The total number of octets transmitted out of the interface, including framing characters.
Received Errors	The number of inbound packets that contained errors preventing them from being deliverable to a higher-layer protocol.

Table 7: Port Statistics (Continued)

Parameter	Description
Transmitted Errors	The number of outbound packets that could not be transmitted because of errors.
Received Unicast Packets	The number of subnetwork-unicast packets delivered to a higher-layer protocol.
Transmitted Unicast Packets	The total number of packets that higher-level protocols requested be transmitted to a subnetwork-unicast address, including those that were discarded or not sent.
Received Discarded Packets	The number of inbound packets which were chosen to be discarded even though no errors had been detected to prevent their being deliverable to a higher-layer protocol. One possible reason for discarding such a packet could be to free up buffer space.
Transmitted Discarded Packets	The number of outbound packets which were chosen to be discarded even though no errors had been detected to prevent their being transmitted. One possible reason for discarding such a packet could be to free up buffer space.
Received Multicast Packets	The number of packets, delivered by this sub-layer to a higher (sub-)layer, which were addressed to a multicast address at this sub-layer.
Transmitted Multicast Packets	The total number of packets that higher-level protocols requested be transmitted, and which were addressed to a multicast address at this sub-layer, including those that were discarded or not sent.
Received Broadcast Packets	The number of packets, delivered by this sub-layer to a higher (sub-)layer, which were addressed to a broadcast address at this sub-layer.
Transmitted Broadcast Packets	The total number of packets that higher-level protocols requested be transmitted, and which were addressed to a broadcast address at this sub-layer, including those that were discarded or not sent.
Received Unknown Packets	The number of packets received via the interface which were discarded because of an unknown or unsupported protocol.
<i>Etherlike Statistics</i>	
Single Collision Frames	The number of successfully transmitted frames for which transmission is inhibited by exactly one collision.
Multiple Collision Frames	A count of successfully transmitted frames for which transmission is inhibited by more than one collision. (Due to a chip limitation, this item is not supported on the ECS4110-52T.)
Late Collisions	The number of times that a collision is detected later than 512 bit-times into the transmission of a packet.
Excessive Collisions	A count of frames for which transmission on a particular interface fails due to excessive collisions. This counter does not increment when the interface is operating in full-duplex mode.
Deferred Transmissions	A count of frames for which the first transmission attempt on a particular interface is delayed because the medium was busy.
Frames Too Long	A count of frames received on a particular interface that exceed the maximum permitted frame size.
Alignment Errors	The number of alignment errors (missynchronized data packets).
FCS Errors	A count of frames received on a particular interface that are an integral number of octets in length but do not pass the FCS check. This count does not include frames received with frame-too-long or frame-too-short error.
SQE Test Errors	A count of times that the SQE TEST ERROR message is generated by the PLS sublayer for a particular interface.
Carrier Sense Errors	The number of times that the carrier sense condition was lost or never asserted when attempting to transmit a frame.

Table 7: Port Statistics (Continued)

Parameter	Description
Internal MAC Receive Errors	A count of frames for which reception on a particular interface fails due to an internal MAC sublayer receive error.
Internal MAC Transmit Errors	A count of frames for which transmission on a particular interface fails due to an internal MAC sublayer transmit error.
<i>RMON Statistics</i>	
Drop Events	The total number of events in which packets were dropped due to lack of resources.
Jabbers	The total number of frames received that were longer than 1518 octets (excluding framing bits, but including FCS octets), and had either an FCS or alignment error.
Fragments	The total number of frames received that were less than 64 octets in length (excluding framing bits, but including FCS octets) and had either an FCS or alignment error.
Collisions	The best estimate of the total number of collisions on this Ethernet segment.
Received Octets	Total number of octets of data received on the network. This statistic can be used as a reasonable indication of Ethernet utilization.
Received Packets	The total number of packets (bad, broadcast and multicast) received.
Broadcast Packets	The total number of good packets received that were directed to the broadcast address. Note that this does not include multicast packets.
Multicast Packets	The total number of good packets received that were directed to this multicast address.
Undersize Packets	The total number of packets received that were less than 64 octets long (excluding framing bits, but including FCS octets) and were otherwise well formed.
Oversize Packets	The total number of packets received that were longer than 1518 octets (excluding framing bits, but including FCS octets) and were otherwise well formed.
64 Bytes Packets	The total number of packets (including bad packets) received and transmitted that were 64 octets in length (excluding framing bits but including FCS octets).
65-127 Byte Packets	The total number of packets (including bad packets) received and transmitted where the number of octets fall within the specified range (excluding framing bits but including FCS octets).
128-255 Byte Packets	
256-511 Byte Packets	
512-1023 Byte Packets	
1024-1518 Byte Packets	
1519-1536 Byte Packets	
<i>Utilization Statistics</i>	
Input Octets in kbits per second	Number of octets entering this interface in kbits/second.
Input Packets per second	Number of packets entering this interface per second.
Input Utilization	The input utilization rate for this interface.
Output Octets in kbits per second	Number of octets leaving this interface in kbits/second.
Output Packets per second	Number of packets leaving this interface per second.
Output Utilization	The output utilization rate for this interface.

WEB INTERFACE

To show a list of port statistics:

- 1. Click Interface, Port, Statistics.
- 2. Select the statistics mode to display (Interface, Etherlike, RMON or Utilization).
- 3. Select a port from the drop-down list.
- 4. Use the Refresh button to update the screen.

Figure 39: Showing Port Statistics (Table)

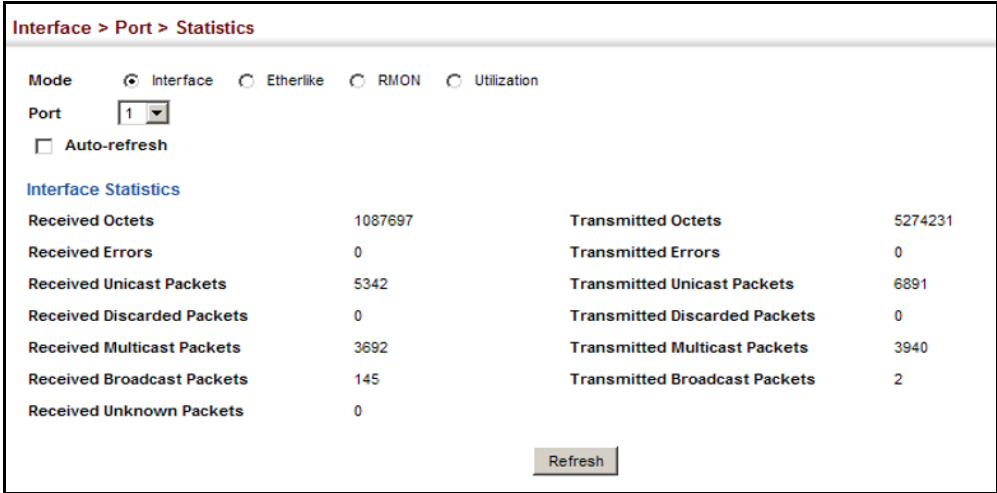

To show a chart of port statistics:

1. Click Interface, Port, Chart.
2. Select the statistics mode to display (Interface, Etherlike, RMON or All).
3. If Interface, Etherlike, RMON statistics mode is chosen, select a port from the drop-down list. If All (ports) statistics mode is chosen, select the statistics type to display.

Figure 40: Showing Port Statistics (Chart)

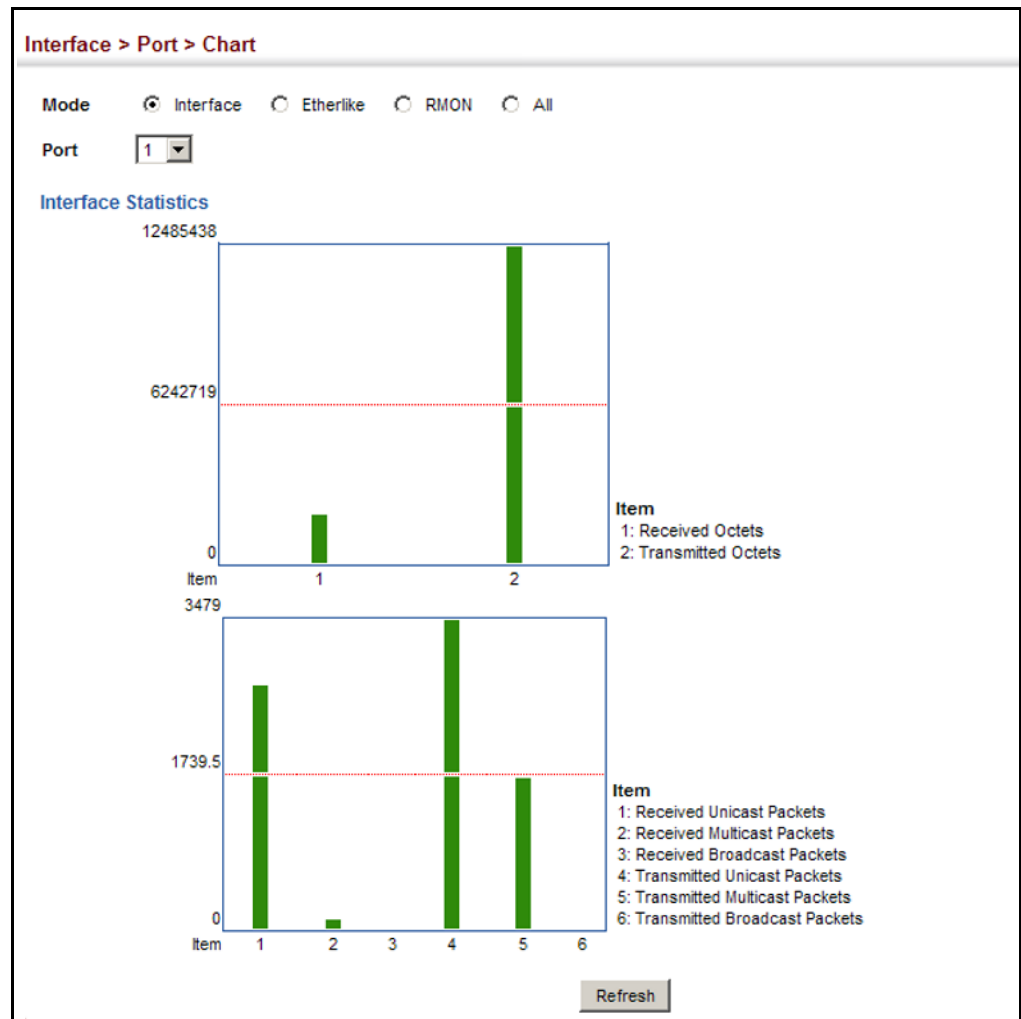

**DISPLAYING
TRANSCEIVER DATA**

Use the Interface > Port > Transceiver page to display identifying information, and operational for optical transceivers which support Digital Diagnostic Monitoring (DDM).

CLI REFERENCES

- ◆ ["show interfaces transceiver" on page 1015](#)

PARAMETERS

These parameters are displayed:

- ◆ **Port** – Port number. (Range: 25-28/49-52)
- ◆ **General** – Information on connector type and vendor-related parameters.
- ◆ **DDM Information** – Information on temperature, supply voltage, laser bias current, laser power, and received optical power.

The switch can display diagnostic information for SFP modules which support the SFF-8472 Specification for Diagnostic Monitoring Interface for Optical Transceivers. This information allows administrators to remotely diagnose problems with optical devices. This feature, referred to as Digital Diagnostic Monitoring (DDM) provides information on transceiver parameters.

WEB INTERFACE

To display identifying information and functional parameters for optical transceivers:

1. Click Interface, Port, Transceiver.
2. Select a port from the scroll-down list.

Figure 41: Displaying Transceiver Data

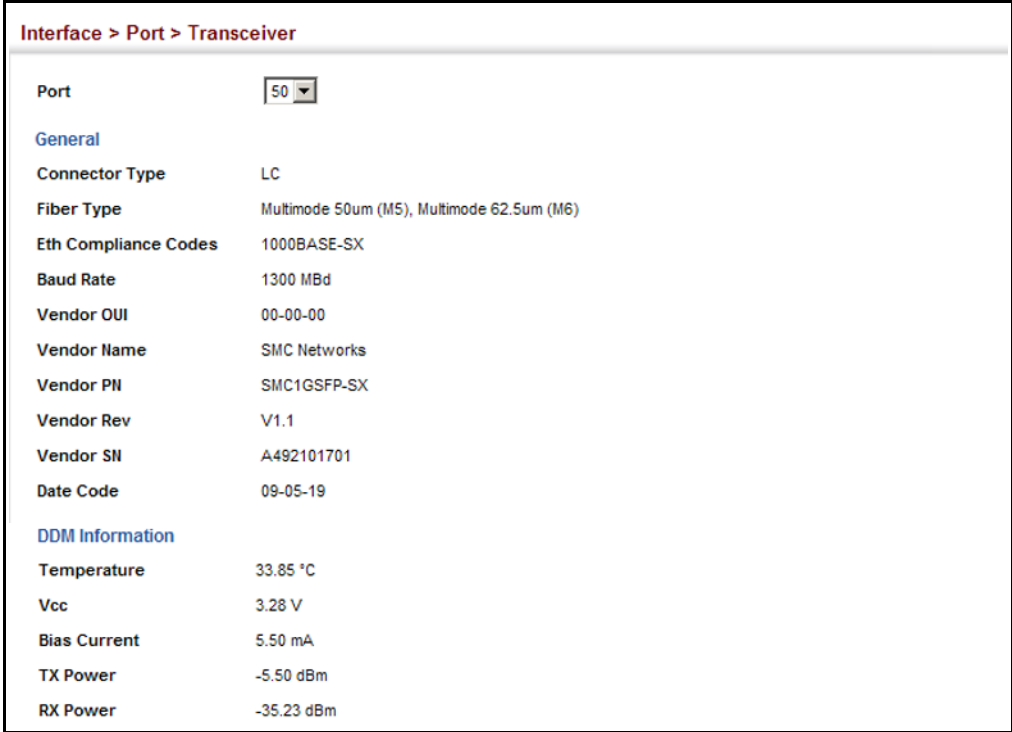

CONFIGURING TRANSCEIVER THRESHOLDS

Use the Interface > Port > Transceiver page to configure thresholds for alarm and warning messages for optical transceivers which support Digital Diagnostic Monitoring (DDM). This page also displays identifying information for supported transceiver types, and operational parameters for transceivers which support DDM.

CLI REFERENCES

- ◆ "transceiver-monitor" on page 1009
- ◆ "transceiver-threshold-auto" on page 1010
- ◆ "transceiver-threshold current" on page 1010
- ◆ "transceiver-threshold rx-power" on page 1011
- ◆ "transceiver-threshold temperature" on page 1012
- ◆ "transceiver-threshold tx-power" on page 1013
- ◆ "transceiver-threshold voltage" on page 1014
- ◆ "show interfaces transceiver-threshold" on page 1016

PARAMETERS

These parameters are displayed:

- ◆ **Port** – Port number. (Range: 1-28/52)
- ◆ **General** – Information on connector type and vendor-related parameters.
- ◆ **DDM Information** – Information on temperature, supply voltage, laser bias current, laser power, and received optical power.

The switch can display diagnostic information for SFP modules which support the SFF-8472 Specification for Diagnostic Monitoring Interface for Optical Transceivers. This information allows administrators to remotely diagnose problems with optical devices. This feature, referred to as Digital Diagnostic Monitoring (DDM) provides information on transceiver parameters.
- ◆ **Trap** – Sends a trap when any of the transceiver's operation values falls outside of specified thresholds. (Default: Disabled)
- ◆ **Auto Mode** – Uses default threshold settings obtained from the transceiver to determine when an alarm or trap message should be sent. (Default: Enabled)
- ◆ **DDM Thresholds** – Information on alarm and warning thresholds. The switch can be configured to send a trap when the measured parameter falls outside of the specified thresholds.

The following alarm and warning parameters are supported:

- **Low Alarm** – Sends an alarm message when the low threshold is crossed.
- **Low Warning** – Sends a warning message when the low threshold is crossed.

- **High Warning** – Sends a warning message when the high threshold is crossed.
- **High Alarm** – Sends an alarm message when the high threshold is crossed.

The configurable ranges are:

- **Temperature:** -128.00-128.00 °C
- **Voltage:** 0.00-6.55 Volts
- **Current:** 0.00-131.00 mA
- **Power:** -40.00-8.20 dBm

The threshold value for Rx and Tx power is calculated as the power ratio in decibels (dB) of the measured power referenced to one milliwatt (mW).

Threshold values for alarm and warning messages can be configured as described below.

- A high-threshold alarm or warning message is sent if the current value is greater than or equal to the threshold, and the last sample value was less than the threshold. After a rising event has been generated, another such event will not be generated until the sampled value has fallen below the high threshold and reaches the low threshold.
- A low-threshold alarm or warning message is sent if the current value is less than or equal to the threshold, and the last sample value was greater than the threshold. After a falling event has been generated, another such event will not be generated until the sampled value has risen above the low threshold and reaches the high threshold.
- Threshold events are triggered as described above to avoid a hysteresis effect which would continuously trigger event messages if the power level were to fluctuate just above and below either the high threshold or the low threshold.
- Trap messages configured by this command are sent to any management station configured as an SNMP trap manager using the Administration > SNMP (Configure Trap) page.

WEB INTERFACE

To configure threshold values for optical transceivers:

1. Click Interface, Port, Transceiver.
2. Select a port from the scroll-down list.
3. Set the switch to send a trap based on default or manual settings.
4. Set alarm and warning thresholds if manual configuration is used.
5. Click Apply.

Figure 42: Configuring Transceiver Thresholds

	Low Alarm	Low Warning	High Warning	High Alarm
Temperature(°C)	-123.00	0.00	70.00	75.00
Voltage(Volts)	3.10	3.15	3.45	3.50
Current(mA)	6.00	7.00	90.00	100.00
Tx Power(dBm)	-12.00	-11.50	-9.50	-9.00
Rx Power(dBm)	-21.50	-21.00	-3.50	-3.00

Trap
 Auto Mode

Click this button to restore default DDM thresholds values.

PERFORMING CABLE DIAGNOSTICS

Use the Interface > Port > Cable Test page to test the cable attached to a port. The cable test will check for any cable faults (short, open, etc.). If a fault is found, the switch reports the length to the fault. Otherwise, it reports the cable length. It can be used to determine the quality of the cable, connectors, and terminations. Problems such as opens, shorts, and cable impedance mismatch can be diagnosed with this test.

CLI REFERENCES

- ◆ "Interface Commands" on page 995

COMMAND USAGE

- ◆ Cable diagnostics are performed using Time Domain Reflectometry (TDR) test methods. TDR analyses the cable by sending a pulsed signal into the cable, and then examining the reflection of that pulse.
- ◆ Cable diagnostics can only be performed on twisted-pair media.
- ◆ This cable test is only accurate for Gigabit Ethernet cables 7 - 100 meters long.
- ◆ The test takes approximately 5 seconds. The switch displays the results of the test immediately upon completion, including common cable failures, as well as the status and approximate length to a fault.
- ◆ Potential conditions which may be listed by the diagnostics include:
 - OK: Correctly terminated pair
 - Open: Open pair, no link partner
 - Short: Shorted pair
 - Not Supported: This message is displayed for any Gigabit Ethernet ports linked up at a speed lower than 1000 Mbps.

- Impedance mismatch: Terminating impedance is not in the reference range.
- ◆ Ports are linked down while running cable diagnostics.

PARAMETERS

These parameters are displayed:

- ◆ **Port** – Switch port identifier.
- ◆ **Type** – Displays media type. (GE – Gigabit Ethernet, Other – SFP)
- ◆ **Link Status** – Shows if the port link is up or down.
- ◆ **Test Result** – The results include common cable failures, as well as the status and approximate distance to a fault, or the approximate cable length if no fault is found.

To ensure more accurate measurement of the length to a fault, first disable power-saving mode on the link partner before running cable diagnostics.

For link-down ports, the reported distance to a fault is accurate to within +/- 2 meters. For link-up ports, the accuracy is +/- 10 meters.

- ◆ **Last Updated** – Shows the last time this port was tested.
- ◆ **Action** – Initiates cable test.

WEB INTERFACE

To test the cable attached to a port:

1. Click Interface, Port, Cable Test.
2. Click Test for any port to start the cable test.

Figure 43: Performing Cable Tests

The screenshot shows a web interface titled "Interface > Port > Cable Test". Below the title is a "Cable Test Port List" table with a total of 52 ports. The table has columns for Port, Type, Link Status, Test Result (Cable/Fault Distance in Meters), Last Updated, and Action. The Test Result column is further divided into Pair A (meters) and Pair B (meters). The first row shows Port 1 with Type GE, Link Status Up, and Test Results OK (0) for both pairs. Ports 2 through 10 are all Down and have Not Tested results. Each row has a "Test" button in the Action column.

Port	Type	Link Status	Test Result (Cable/Fault Distance in Meters)		Last Updated	Action
			Pair A (meters)	Pair B (meters)		
1	GE	Up	OK (0)	OK (0)	2013-10-01 09:39:51	Test
2	GE	Down	Not Tested	Not Tested		Test
3	GE	Down	Not Tested	Not Tested		Test
4	GE	Down	Not Tested	Not Tested		Test
5	GE	Down	Not Tested	Not Tested		Test
6	GE	Down	Not Tested	Not Tested		Test
7	GE	Down	Not Tested	Not Tested		Test
8	GE	Down	Not Tested	Not Tested		Test
9	GE	Down	Not Tested	Not Tested		Test
10	GE	Down	Not Tested	Not Tested		Test

Note: After every test action, wait several seconds and click the refresh button to display test results.

TRUNK CONFIGURATION

This section describes how to configure static and dynamic trunks.

You can create multiple links between devices that work as one virtual, aggregate link. A port trunk offers a dramatic increase in bandwidth for network segments where bottlenecks exist, as well as providing a fault-tolerant link between two devices. You can create up to 16 trunks at a time on the switch.

The switch supports both static trunking and dynamic Link Aggregation Control Protocol (LACP). Static trunks have to be manually configured at both ends of the link, and the switches must comply with the Cisco EtherChannel standard. On the other hand, LACP configured ports can automatically negotiate a trunked link with LACP-configured ports on another device. You can configure any number of ports on the switch as LACP, as long as they are not already configured as part of a static trunk. If ports on another device are also configured as LACP, the switch and the other device will negotiate a trunk link between them. If an LACP trunk consists of more than eight ports, all other ports will be placed in standby mode. Should one link in the trunk fail, one of the standby ports will automatically be activated to replace it.

COMMAND USAGE

Besides balancing the load across each port in the trunk, the other ports provide redundancy by taking over the load if a port in the trunk fails. However, before making any physical connections between devices, use the web interface or CLI to specify the trunk on the devices at both ends. When using a trunk, take note of the following points:

- ◆ Finish configuring trunks before you connect the corresponding network cables between switches to avoid creating a loop.
- ◆ You can create up to 16 trunks on a switch, with up to eight ports per trunk.
- ◆ The ports at both ends of a connection must be configured as trunk ports.
- ◆ When configuring static trunks on switches of different types, they must be compatible with the Cisco EtherChannel standard.
- ◆ The ports at both ends of a trunk must be configured in an identical manner, including communication mode (i.e., speed, duplex mode and flow control), VLAN assignments, and CoS settings.
- ◆ Any of the Gigabit ports on the front panel can be trunked together, including ports of different media types.
- ◆ All the ports in a trunk have to be treated as a whole when moved from/to, added or deleted from a VLAN.
- ◆ STP, VLAN, and IGMP settings can only be made for the entire trunk.

CONFIGURING A STATIC TRUNK Use the Interface > Trunk > Static page to create a trunk, assign member ports, and configure the connection parameters.

Figure 44: Configuring Static Trunks

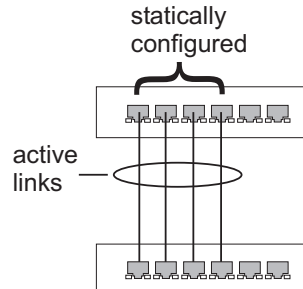

CLI REFERENCES

- ◆ "Link Aggregation Commands" on page 1021
- ◆ "Interface Commands" on page 995

COMMAND USAGE

- ◆ When configuring static trunks, you may not be able to link switches of different types, depending on the vendor's implementation. However, note that the static trunks on this switch are Cisco EtherChannel compatible.
- ◆ To avoid creating a loop in the network, be sure you add a static trunk via the configuration interface before connecting the ports, and also disconnect the ports before removing a static trunk via the configuration interface.

PARAMETERS

These parameters are displayed:

- ◆ **Trunk ID** – Trunk identifier. (Range: 1-16)
- ◆ **Member** – The initial trunk member. Use the Add Member page to configure additional members.
 - **Unit** – Unit identifier. (Range: 1)
 - **Port** – Port identifier. (Range: 1-28/52)

WEB INTERFACE

To create a static trunk:

1. Click Interface, Trunk, Static.
2. Select Configure Trunk from the Step list.
3. Select Add from the Action list.
4. Enter a trunk identifier.

5. Set the unit and port for the initial trunk member.
6. Click Apply.

Figure 45: Creating Static Trunks

Interface > Trunk > Static

Step: 1. Configure Trunk Action: Add

Trunk ID (1-16)

Member Unit 1 Port 5

Apply Revert

To add member ports to a static trunk:

1. Click Interface, Trunk, Static.
2. Select Configure Trunk from the Step list.
3. Select Add Member from the Action list.
4. Select a trunk identifier.
5. Set the unit and port for an additional trunk member.
6. Click Apply.

Figure 46: Adding Static Trunks Members

Interface > Trunk > Static

Step: 1. Configure Trunk Action: Add Member

Trunk 1

Member Unit 1 Port 1

Apply Revert

To configure connection parameters for a static trunk:

1. Click Interface, Trunk, Static.
2. Select Configure General from the Step list.
3. Select Configure from the Action list.
4. Modify the required interface settings. (Refer to "[Configuring by Port List](#)" on page 156 for a description of the parameters.)
5. Click Apply.

Figure 47: Configuring Connection Parameters for a Static Trunk

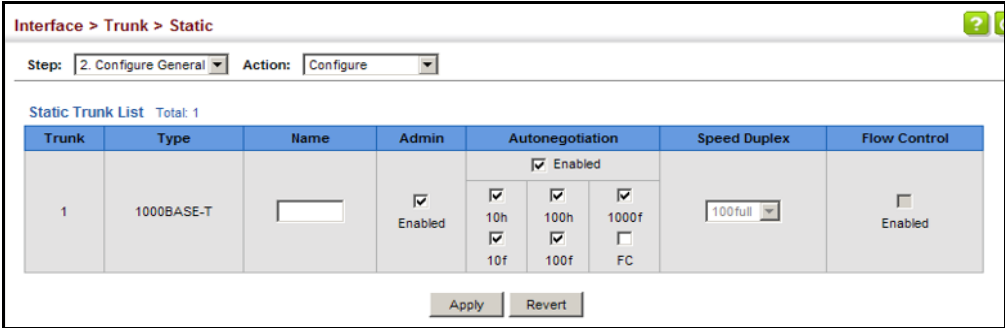

To display trunk connection parameters:

1. Click Interface, Trunk, Static.
2. Select Configure General from the Step list.
3. Select Show Information from the Action list.

Figure 48: Showing Information for Static Trunks

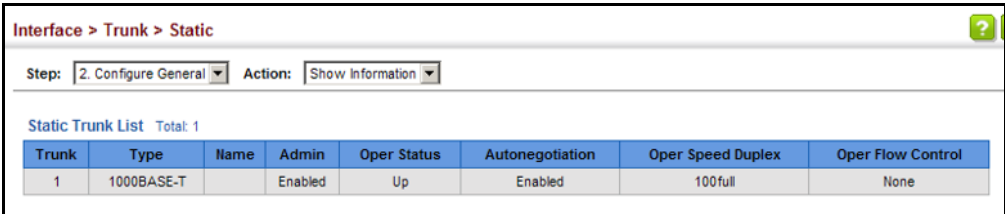

CONFIGURING A DYNAMIC TRUNK

Use the Interface > Trunk > Dynamic pages to set the administrative key for an aggregation group, enable LACP on a port, configure protocol parameters for local and partner ports, or to set Ethernet connection parameters.

Figure 49: Configuring Dynamic Trunks

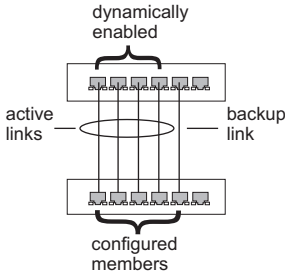

CLI REFERENCES

- ◆ "Link Aggregation Commands" on page 1021

COMMAND USAGE

- ◆ To avoid creating a loop in the network, be sure you enable LACP before connecting the ports, and also disconnect the ports before disabling LACP.
- ◆ If the target switch has also enabled LACP on the connected ports, the trunk will be activated automatically.
- ◆ A trunk formed with another switch using LACP will automatically be assigned the next available trunk ID.
- ◆ If more than eight ports attached to the same target switch have LACP enabled, the additional ports will be placed in standby mode, and will only be enabled if one of the active links fails.
- ◆ All ports on both ends of an LACP trunk must be configured for full duplex, and auto-negotiation.
- ◆ Ports are only allowed to join the same Link Aggregation Group (LAG) if (1) the LACP port system priority matches, (2) the LACP port admin key matches, and (3) the LAG admin key matches (if configured). However, if the LAG admin key is set, then the port admin key must be set to the same value for a port to be allowed to join that group.



NOTE: If the LACP admin key is not set when a channel group is formed (i.e., it has a null value of 0), the operational value of this key is set to the same value as the port admin key used by the interfaces that joined the group (see the [show lacp internal](#) command described on [page 1030](#)).

PARAMETERS

These parameters are displayed:

Configure Aggregator

- ◆ **Admin Key** – LACP administration key is used to identify a specific link aggregation group (LAG) during local LACP setup on the switch. (Range: 0-65535)

If the port channel admin key is not set when a channel group is formed (i.e., it has the null value of 0), this key is set to the same value as the port admin key (see *Configure Aggregation Port - Actor/Partner*) used by the interfaces that joined the group. Note that when the LAG is no longer used, the port channel admin key is reset to 0.

If the port channel admin key is set to a non-default value, the operational key is based upon LACP PDUs received from the partner, and the channel admin key is reset to the default value. The trunk identifier will also be changed by this process.

- ◆ **Timeout Mode** – The timeout to wait for the next LACP data unit (LACPDU):

- **Long Timeout** – Specifies a slow timeout of 90 seconds. (This is the default setting.)
- **Short Timeout** – Specifies a fast timeout of 3 seconds.

The timeout is set in the LACP timeout bit of the Actor State field in transmitted LACPDU. When the partner switch receives an LACPDU set with a short timeout from the actor switch, the partner adjusts the transmit LACPDU interval to 1 second. When it receives an LACPDU set with a long timeout from the actor, it adjusts the transmit LACPDU interval to 30 seconds.

If the actor does not receive an LACPDU from its partner before the configured timeout expires, the partner port information will be deleted from the LACP group.

When a dynamic port-channel member leaves a port-channel, the default timeout value will be restored on that port.

When a dynamic port-channel is torn down, the configured timeout value will be retained. When the dynamic port-channel is constructed again, that timeout value will be used.

Configure Aggregation Port - General

- ◆ **Port** – Port identifier. (Range: 1-28/52)
- ◆ **LACP Status** – Enables or disables LACP on a port.

Configure Aggregation Port - Actor/Partner

- ◆ **Port** – Port number. (Range: 1-28/52)
- ◆ **Admin Key** – The LACP administration key must be set to the same value for ports that belong to the same LAG. (Range: 0-65535; Default – Actor: 1, Partner: 0)

By default, the actor's operational key is determined by port's link speed (1000f - 4, 100f - 3, 10f - 2), and copied to the admin key.

- ◆ **System Priority** – LACP system priority is used to determine link aggregation group (LAG) membership, and to identify this device to other switches during LAG negotiations. (Range: 0-65535; Default: 32768)

System priority is combined with the switch's MAC address to form the LAG identifier. This identifier is used to indicate a specific LAG during LACP negotiations with other systems.

- ◆ **Port Priority** – If a link goes down, LACP port priority is used to select a backup link. (Range: 0-65535; Default: 32768)
 - Setting a lower value indicates a higher effective priority.
 - If an active port link goes down, the backup port with the highest priority is selected to replace the downed link. However, if two or

more ports have the same LACP port priority, the port with the lowest physical port number will be selected as the backup port.

- If an LAG already exists with the maximum number of allowed port members, and LACP is subsequently enabled on another port using a higher priority than an existing member, the newly configured port will replace an existing port member that has a lower priority.



NOTE: Configuring LACP settings for a port only applies to its administrative state, not its operational state, and will only take effect the next time an aggregate link is established with that port.

NOTE: Configuring the port partner sets the remote side of an aggregate link; i.e., the ports on the attached device. The command attributes have the same meaning as those used for the port actor.

WEB INTERFACE

To configure the admin key for a dynamic trunk:

1. Click Interface, Trunk, Dynamic.
2. Select Configure Aggregator from the Step list.
3. Set the Admin Key and timeout mode for the required LACP group.
4. Click Apply.

Figure 50: Configuring the LACP Aggregator Admin Key

The screenshot shows a web interface for configuring LACP aggregator admin keys. The breadcrumb path is "Interface > Trunk > Dynamic". The "Step:" dropdown is set to "1. Configure Aggregator". Below this is a "Trunk List" table with 16 total trunks, showing the first 5. Each row has columns for "Trunk", "Admin Key (0-65535)", and "Timeout Mode".

Trunk	Admin Key (0-65535)	Timeout Mode
1	0	Long Timeout
2	0	Long Timeout
3	0	Long Timeout
4	0	Long Timeout
5	0	Long Timeout

To enable LACP for a port:

- 1. Click Interface, Trunk, Dynamic.
- 2. Select Configure Aggregation Port from the Step list.
- 3. Select Configure from the Action list.
- 4. Click General.
- 5. Enable LACP on the required ports.
- 6. Click Apply.

Figure 51: Enabling LACP on a Port

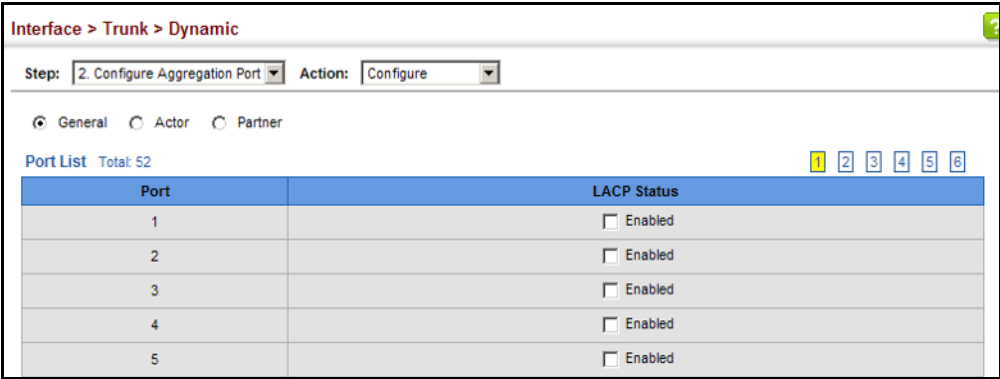

To configure LACP parameters for group members:

1. Click Interface, Trunk, Dynamic.
2. Select Configure Aggregation Port from the Step list.
3. Select Configure from the Action list.
4. Click Actor or Partner.
5. Configure the required settings.
6. Click Apply.

Figure 52: Configuring LACP Parameters on a Port

Port	Admin Key (0-65535)	System Priority (0-65535)	Port Priority (0-65535)
1	3	32768	32768
2	1	32768	32768
3	1	32768	32768
4	1	32768	32768
5	1	32768	32768

To show the active members of a dynamic trunk:

1. Click Interface, Trunk, Dynamic.
2. Select Configure Trunk from the Step list.
3. Select Show Member from the Action list.
4. Select a Trunk.

Figure 53: Showing Members of a Dynamic Trunk

Member (Unit/Port)
1/1
1/2

To configure connection parameters for a dynamic trunk:

1. Click Interface, Trunk, Dynamic.
2. Select Configure Trunk from the Step list.
3. Select Configure from the Action list.
4. Modify the required interface settings. (See "Configuring by Port List" on page 156 for a description of the interface settings.)
5. Click Apply.

Figure 54: Configuring Connection Settings for a Dynamic Trunk

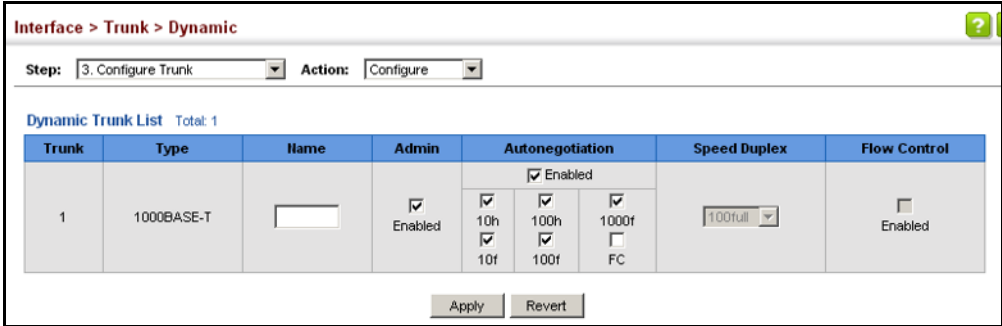

To show connection parameters for a dynamic trunk:

1. Click Interface, Trunk, Dynamic.
2. Select Configure Trunk from the Step list.
3. Select Show from the Action list.

Figure 55: Showing Connection Parameters for Dynamic Trunks

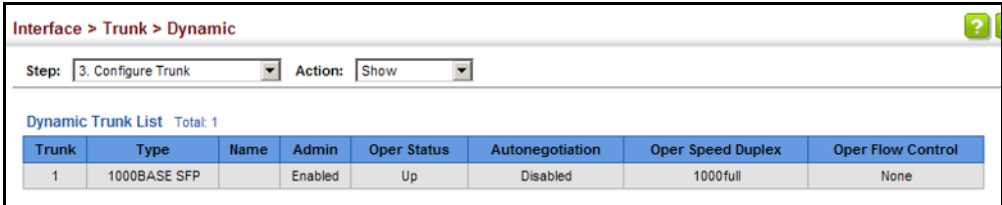

DISPLAYING LACP PORT COUNTERS

Use the Interface > Trunk > Dynamic (Configure Aggregation Port - Show Information - Counters) page to display statistics for LACP protocol messages.

CLI REFERENCES

- ◆ "show lacp" on page 1030

PARAMETERS

These parameters are displayed:

Table 8: LACP Port Counters

Parameter	Description
LACPDU Sent	Number of valid LACPDU transmitted from this channel group.
LACPDU Received	Number of valid LACPDU received on this channel group.
Marker Sent	Number of valid Marker PDUs transmitted from this channel group.
Marker Received	Number of valid Marker PDUs received by this channel group.
Marker Unknown Pkts	Number of frames received that either (1) Carry the Slow Protocols Ethernet Type value, but contain an unknown PDU, or (2) are addressed to the Slow Protocols group MAC Address, but do not carry the Slow Protocols Ethernet Type.
Marker Illegal Pkts	Number of frames that carry the Slow Protocols Ethernet Type value, but contain a badly formed PDU or an illegal value of Protocol Subtype.

WEB INTERFACE

To display LACP port counters:

1. Click Interface, Trunk, Dynamic.
2. Select Configure Aggregation Port from the Step list.
3. Select Show Information from the Action list.
4. Click Counters.
5. Select a group member from the Port list.

Figure 56: Displaying LACP Port Counters

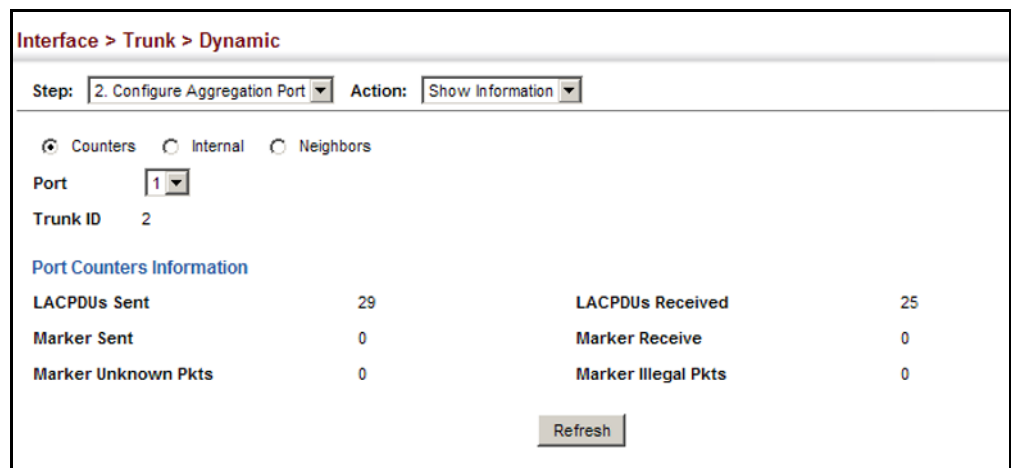

DISPLAYING LACP SETTINGS AND STATUS FOR THE LOCAL SIDE

Use the Interface > Trunk > Dynamic (Configure Aggregation Port - Show Information - Internal) page to display the configuration settings and operational state for the local side of a link aggregation.

CLI REFERENCES

- ◆ "show lacp" on page 1030

PARAMETERS

These parameters are displayed:

Table 9: LACP Internal Configuration Information

Parameter	Description
LACP System Priority	LACP system priority assigned to this port channel.
LACP Port Priority	LACP port priority assigned to this interface within the channel group.
Admin Key	Current administrative value of the key for the aggregation port.
Oper Key	Current operational value of the key for the aggregation port.
LACPDUs Interval	Number of seconds before invalidating received LACPDU information.
Admin State, Oper State	Administrative or operational values of the actor's state parameters: <ul style="list-style-type: none"> ◆ Expired – The actor's receive machine is in the expired state; ◆ Defaulted – The actor's receive machine is using defaulted operational partner information, administratively configured for the partner. ◆ Distributing – If false, distribution of outgoing frames on this link is disabled; i.e., distribution is currently disabled and is not expected to be enabled in the absence of administrative changes or changes in received protocol information. ◆ Collecting – Collection of incoming frames on this link is enabled; i.e., collection is currently enabled and is not expected to be disabled in the absence of administrative changes or changes in received protocol information. ◆ Synchronization – The System considers this link to be IN_SYNC; i.e., it has been allocated to the correct Link Aggregation Group, the group has been associated with a compatible Aggregator, and the identity of the Link Aggregation Group is consistent with the System ID and operational Key information transmitted. ◆ Aggregation – The system considers this link to be aggregatable; i.e., a potential candidate for aggregation. ◆ Long timeout – Periodic transmission of LACPDUs uses a slow transmission rate. ◆ LACP-Activity – Activity control value with regard to this link. (0: Passive; 1: Active)

WEB INTERFACE

To display LACP settings and status for the local side:

1. Click Interface, Trunk, Dynamic.
2. Select Configure Aggregation Port from the Step list.
3. Select Show Information from the Action list.
4. Click Internal.
5. Select a group member from the Port list.

Figure 57: Displaying LACP Port Internal Information

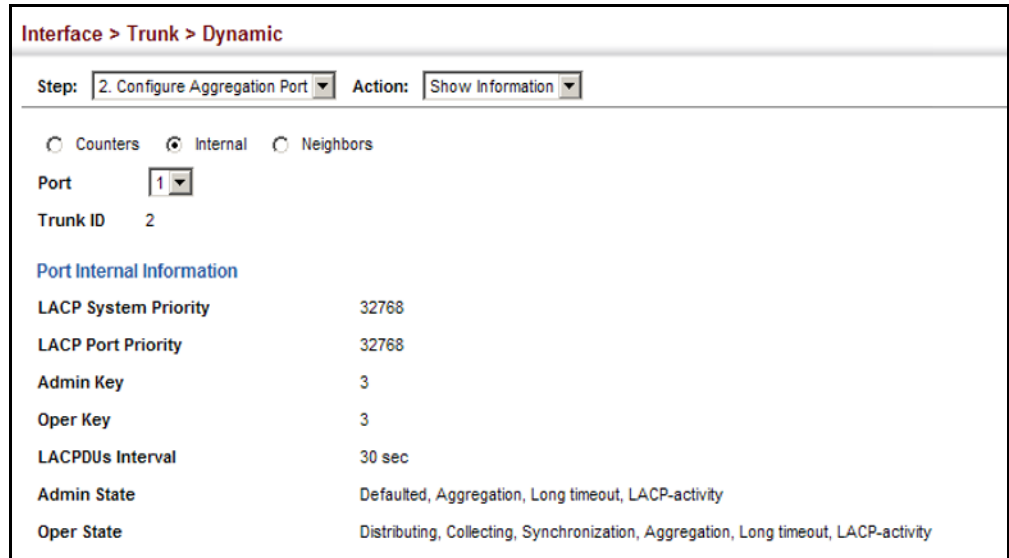

DISPLAYING LACP SETTINGS AND STATUS FOR THE REMOTE SIDE

Use the Interface > Trunk > Dynamic (Configure Aggregation Port - Show Information - Neighbors) page to display the configuration settings and operational state for the remote side of a link aggregation.

CLI REFERENCES

- ◆ "show lacp" on page 1030

PARAMETERS

These parameters are displayed:

Table 10: LACP Remote Device Configuration Information

Parameter	Description
Partner Admin System ID	LAG partner’s system ID assigned by the user.
Partner Oper System ID	LAG partner’s system ID assigned by the LACP protocol.
Partner Admin Port Number	Current administrative value of the port number for the protocol Partner.
Partner Oper Port Number	Operational port number assigned to this aggregation port by the port’s protocol partner.
Port Admin Priority	Current administrative value of the port priority for the protocol partner.
Port Oper Priority	Priority value assigned to this aggregation port by the partner.
Admin Key	Current administrative value of the Key for the protocol partner.
Oper Key	Current operational value of the Key for the protocol partner.
Admin State	Administrative values of the partner’s state parameters. (See preceding table.)
Oper State	Operational values of the partner’s state parameters. (See preceding table.)

WEB INTERFACE

To display LACP settings and status for the remote side:

1. Click Interface, Trunk, Dynamic.
2. Select Configure Aggregation Port from the Step list.
3. Select Show Information from the Action list.
4. Click Internal.
5. Select a group member from the Port list.

Figure 58: Displaying LACP Port Remote Information

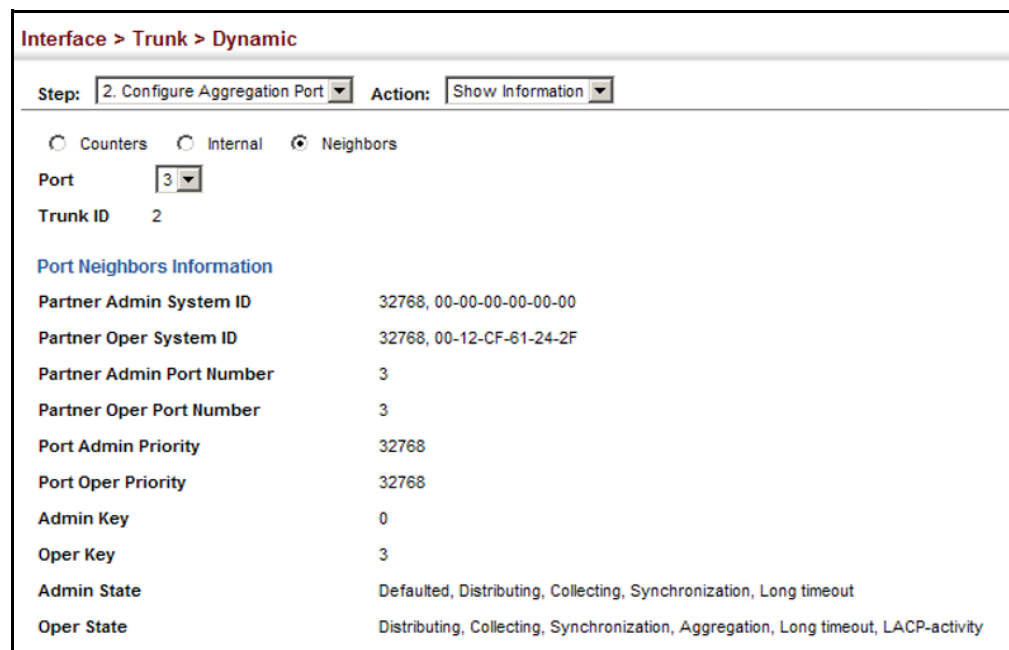

CONFIGURING LOAD BALANCING Use the Interface > Trunk > Load Balance page to set the load-distribution method used among ports in aggregated links.

CLI REFERENCES

- ◆ ["port channel load-balance" on page 1022](#)

COMMAND USAGE

- ◆ This command applies to all static and dynamic trunks on the switch.
- ◆ To ensure that the switch traffic load is distributed evenly across all links in a trunk, select the source and destination addresses used in the load-balance calculation to provide the best result for trunk connections:
 - **Destination IP Address:** All traffic with the same destination IP address is output on the same link in a trunk. This mode works best

for switch-to-router trunk links where traffic through the switch is destined for many different hosts. Do not use this mode for switch-to-server trunk links where the destination IP address is the same for all traffic.

- **Destination MAC Address:** All traffic with the same destination MAC address is output on the same link in a trunk. This mode works best for switch-to-switch trunk links where traffic through the switch is destined for many different hosts. Do not use this mode for switch-to-router trunk links where the destination MAC address is the same for all traffic.
- **Source and Destination IP Address:** All traffic with the same source and destination IP address is output on the same link in a trunk. This mode works best for switch-to-router trunk links where traffic through the switch is received from and destined for many different hosts.
- **Source and Destination MAC Address:** All traffic with the same source and destination MAC address is output on the same link in a trunk. This mode works best for switch-to-switch trunk links where traffic through the switch is received from and destined for many different hosts.
- **Source IP Address:** All traffic with the same source IP address is output on the same link in a trunk. This mode works best for switch-to-router or switch-to-server trunk links where traffic through the switch is received from many different hosts.
- **Source MAC Address:** All traffic with the same source MAC address is output on the same link in a trunk. This mode works best for switch-to-switch trunk links where traffic through the switch is received from many different hosts.

PARAMETERS

These parameters are displayed for the load balance mode:

- ◆ **Destination IP Address** - Load balancing based on destination IP address.
- ◆ **Destination MAC Address** - Load balancing based on destination MAC address.
- ◆ **Source and Destination IP Address** - Load balancing based on source and destination IP address.
- ◆ **Source and Destination MAC Address** - Load balancing based on source and destination MAC address.
- ◆ **Source IP Address** - Load balancing based on source IP address.
- ◆ **Source MAC Address** - Load balancing based on source MAC address.

WEB INTERFACE

To display the load-distribution method used by ports in aggregated links:

1. Click Interface, Trunk, Load Balance.
2. Select the required method from the Load Balance Mode list.
3. Click Apply.

Figure 59: Configuring Load Balancing

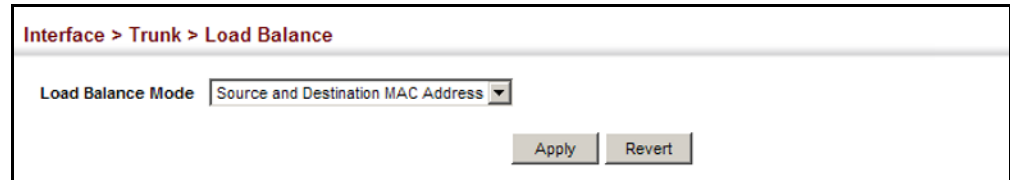

Interface > Trunk > Load Balance

Load Balance Mode: Source and Destination MAC Address

Apply Revert

SAVING POWER

Use the Interface > Green Ethernet page to enable power savings mode on the selected port.

CLI REFERENCES

- ◆ ["power-save" on page 1019](#)
- ◆ ["show power-save" on page 1020](#)

COMMAND USAGE

- ◆ IEEE 802.3 defines the Ethernet standard and subsequent power requirements based on cable connections operating at 100 meters. Enabling power saving mode can reduce power used for cable lengths of 60 meters or less, with more significant reduction for cables of 20 meters or less, and continue to ensure signal integrity.
- ◆ The power-saving methods provided by this switch include:
 - Power saving when there is no link partner:

Under normal operation, the switch continuously auto-negotiates to find a link partner, keeping the MAC interface powered up even if no link connection exists. When using power-savings mode, the switch checks for energy on the circuit to determine if there is a link partner. If none is detected, the switch automatically turns off the transmitter, and most of the receive circuitry (entering Sleep Mode). In this mode, the low-power energy-detection circuit continuously checks for energy on the cable. If none is detected, the MAC interface is also powered down to save additional energy. If energy is detected, the switch immediately turns on both the transmitter and receiver functions, and powers up the MAC interface.

- Power saving when there is a link partner:

Traditional Ethernet connections typically operate with enough power to support at least 100 meters of cable even though average network cable length is shorter. When cable length is shorter, power consumption can be reduced since signal attenuation is proportional to cable length. When power-savings mode is enabled, the switch analyzes cable length to determine whether or not it can reduce the signal amplitude used on a particular link.



NOTE: Power savings can only be implemented on Gigabit Ethernet ports when using twisted-pair cabling. Power-savings mode on a active link only works when connection speed is 1 Gbps, and line length is less than 60 meters.

PARAMETERS

These parameters are displayed:

- ◆ **Port** – Power saving mode only applies to the Gigabit Ethernet ports using copper media.
- ◆ **Power Saving Status** – Adjusts the power provided to ports based on the length of the cable used to connect to other devices. Only sufficient power is used to maintain connection requirements. (Default: Enabled on Gigabit Ethernet RJ-45 ports)

WEB INTERFACE

To enable power savings:

1. Click Interface, Green Ethernet.
2. Mark the Enabled check box for a port.
3. Click Apply.

Figure 60: Enabling Power Savings

The screenshot shows a web interface for configuring Green Ethernet. At the top, it says 'Interface > Green Ethernet'. Below that, there's a 'Port Green Ethernet List' with a 'Total: 52' and a pagination control showing '1 2 3 4 5 6'. The main table has two columns: 'Port' and 'Power Saving Status'. The 'Port' column lists ports 1 through 10. The 'Power Saving Status' column shows a checked checkbox followed by the text 'Enabled' for each port. At the bottom of the table, there are two buttons: 'Apply' and 'Revert'.

Port	Power Saving Status
1	<input checked="" type="checkbox"/> Enabled
2	<input checked="" type="checkbox"/> Enabled
3	<input checked="" type="checkbox"/> Enabled
4	<input checked="" type="checkbox"/> Enabled
5	<input checked="" type="checkbox"/> Enabled
6	<input checked="" type="checkbox"/> Enabled
7	<input checked="" type="checkbox"/> Enabled
8	<input checked="" type="checkbox"/> Enabled
9	<input checked="" type="checkbox"/> Enabled
10	<input checked="" type="checkbox"/> Enabled

TRAFFIC SEGMENTATION

If tighter security is required for passing traffic from different clients through downlink ports on the local network and over uplink ports to the service provider, port-based traffic segmentation can be used to isolate traffic for individual clients.

Traffic belonging to each client is isolated to the allocated downlink ports. But the switch can be configured to either isolate traffic passing across a client's allocated uplink ports from the uplink ports assigned to other clients, or to forward traffic through the uplink ports used by other clients, allowing different clients to share access to their uplink ports where security is less likely to be compromised.

ENABLING TRAFFIC SEGMENTATION Use the Interface > Traffic Segmentation (Configure Global) page to enable traffic segmentation.

CLI REFERENCES

- ◆ ["Port-based Traffic Segmentation" on page 963](#)

PARAMETERS

These parameters are displayed:

- ◆ **Status** – Enables port-based traffic segmentation. (Default: Disabled)
- ◆ **Uplink-to-Uplink Mode** – Specifies whether or not traffic can be forwarded between uplink ports assigned to different client sessions.
 - **Blocking** – Blocks traffic between uplink ports assigned to different sessions.
 - **Forwarding** – Forwards traffic between uplink ports assigned to different sessions.

WEB INTERFACE

To enable traffic segmentation:

1. Click Interface, Traffic Segmentation.
2. Select Configure Global from the Step list.
3. Mark the Status check box, and set the required uplink-to-uplink mode.
4. Click Apply.

Figure 61: Enabling Traffic Segmentation



CONFIGURING UPLINK AND DOWNLINK PORTS

Use the Interface > Traffic Segmentation (Configure Session) page to assign the downlink and uplink ports to use in the segmented group. Ports designated as downlink ports can not communicate with any other ports on the switch except for the uplink ports. Uplink ports can communicate with any other ports on the switch and with any designated downlink ports.

CLI REFERENCES

- ◆ "Port-based Traffic Segmentation" on page 963

COMMAND USAGE

- ◆ When traffic segmentation is enabled, the forwarding state for the uplink and downlink ports assigned to different client sessions is shown below.

Table 11: Traffic Segmentation Forwarding

Destination Source	Session #1 Downlinks	Session #1 Uplinks	Session #2 Downlinks	Session #2 Uplinks	Normal Ports
Session #1 Downlink Ports	Blocking	Forwarding	Blocking	Blocking	Blocking
Session #1 Uplink Ports	Forwarding	Forwarding	Blocking	Blocking/ Forwarding*	Forwarding
Session #2 Downlink Ports	Blocking	Blocking	Blocking	Forwarding	Blocking
Session #2 Uplink Ports	Blocking	Blocking/ Forwarding*	Forwarding	Forwarding	Forwarding
Normal Ports	Forwarding	Forwarding	Forwarding	Forwarding	Forwarding

* The forwarding state for uplink-to-uplink ports is configured on the Configure Global page (see [page 193](#)).

- ◆ When traffic segmentation is disabled, all ports operate in normal forwarding mode based on the settings specified by other functions such as VLANs and spanning tree protocol.
- ◆ A port cannot be configured in both an uplink and downlink list.
- ◆ A port can only be assigned to one traffic-segmentation session.
- ◆ A downlink port can only communicate with an uplink port in the same session. Therefore, if an uplink port is not configured for a session, the

assigned downlink ports will not be able to communicate with any other ports.

- ◆ If a downlink port is not configured for the session, the assigned uplink ports will operate as normal ports.

PARAMETERS

These parameters are displayed:

- ◆ **Session ID** – Traffic segmentation session. (Range: 1-4)
- ◆ **Direction** – Adds an interface to the segmented group by setting the direction to uplink or downlink. (Default: Uplink)
- ◆ **Interface** – Displays a list of ports or trunks.
- ◆ **Port** – Port Identifier. (Range: 1-28/52)
- ◆ **Trunk** – Trunk Identifier. (Range: 1-16)

WEB INTERFACE

To configure the members of the traffic segmentation group:

1. Click Interface, Traffic Segmentation.
2. Select Configure Session from the Step list.
3. Select Add from the Action list.
4. Enter the session ID, set the direction to uplink or downlink, and select the interface to add.
5. Click Apply.

Figure 62: Configuring Members for Traffic Segmentation

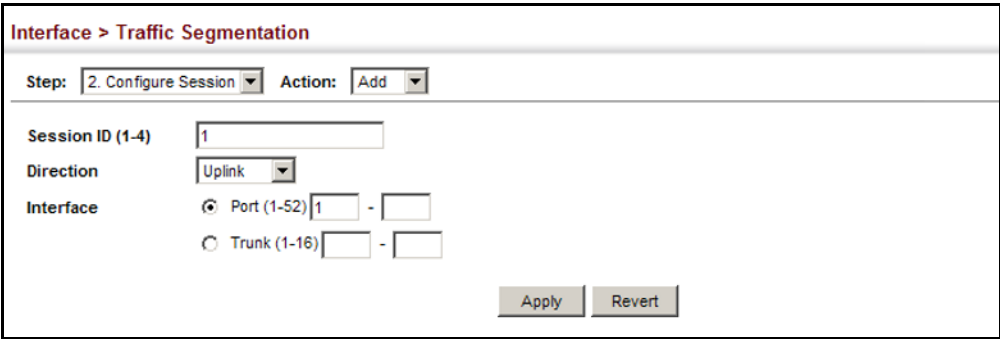

To show the members of the traffic segmentation group:

1. Click Interface, Traffic Segmentation.
2. Select Configure Session from the Step list.
3. Select Show from the Action list.

Figure 63: Showing Traffic Segmentation Members

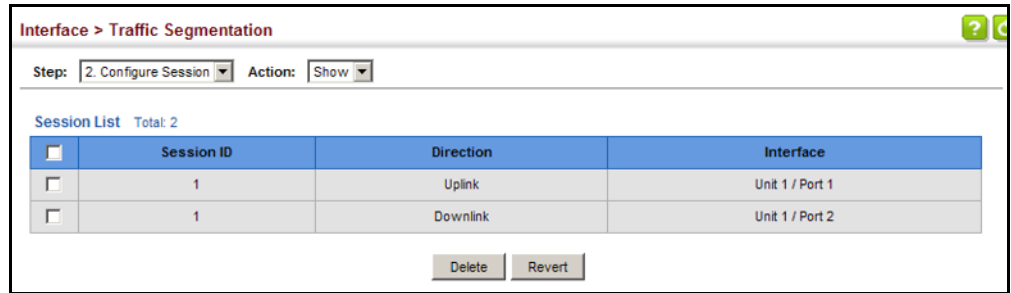

VLAN TRUNKING

Use the Interface > VLAN Trunking page to allow unknown VLAN groups to pass through the specified interface.

CLI REFERENCES

- ◆ "vlan-trunking" on page 1162

COMMAND USAGE

- ◆ Use this feature to configure a tunnel across one or more intermediate switches which pass traffic for VLAN groups to which they do not belong.

The following figure shows VLANs 1 and 2 configured on switches A and B, with VLAN trunking being used to pass traffic for these VLAN groups across switches C, D and E.

Figure 64: Configuring VLAN Trunking

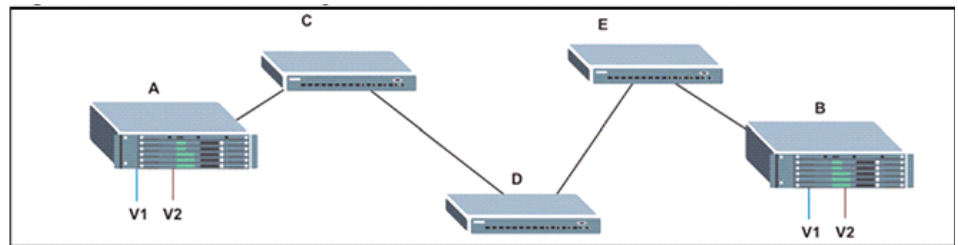

Without VLAN trunking, you would have to configure VLANs 1 and 2 on all intermediate switches – C, D and E; otherwise these switches would drop any frames with unknown VLAN group tags. However, by enabling VLAN trunking on the intermediate switch ports along the path

connecting VLANs 1 and 2, you only need to create these VLAN groups in switches A and B. Switches C, D and E automatically allow frames with VLAN group tags 1 and 2 (groups that are unknown to those switches) to pass through their VLAN trunking ports.

- ◆ VLAN trunking is mutually exclusive with the “access” switchport mode (see ["Adding Static Members to VLANs" on page 205](#)). If VLAN trunking is enabled on an interface, then that interface cannot be set to access mode, and vice versa.
- ◆ To prevent loops from forming in the spanning tree, all unknown VLANs will be bound to a single instance (either STP/RSTP or an MSTP instance, depending on the selected STA mode).
- ◆ If both VLAN trunking and ingress filtering are disabled on an interface, packets with unknown VLAN tags will still be allowed to enter this interface and will be flooded to all other ports where VLAN trunking is enabled. (In other words, VLAN trunking will still be effectively enabled for the unknown VLAN).

PARAMETERS

These parameters are displayed:

- ◆ **Interface** – Displays a list of ports or trunks.
- ◆ **Port** – Port Identifier. (Range: 1-28/52)
- ◆ **Trunk** – Trunk Identifier. (Range: 1-16)
- ◆ **VLAN Trunking Status** – Enables VLAN trunking on the selected interface.

WEB INTERFACE

To enable VLAN trunking on a port or trunk:

1. Click Interface, VLAN Trunking.
2. Click Port or Trunk to specify the interface type.
3. Enable VLAN trunking on any of the ports or on a trunk.
4. Click Apply.

Figure 65: Configuring VLAN Trunking

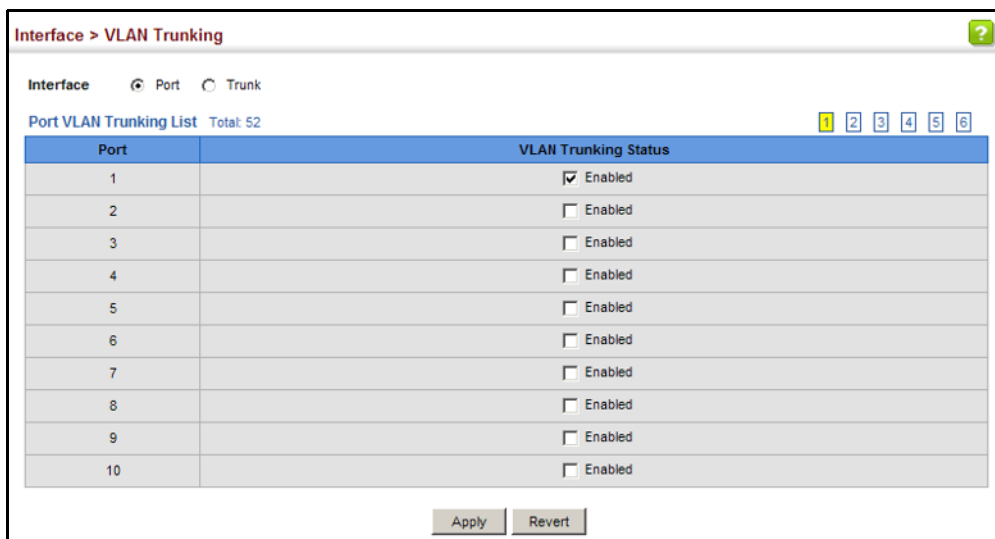

This chapter includes the following topics:

- ◆ **IEEE 802.1Q VLANs** – Configures static and dynamic VLANs.
- ◆ **IEEE 802.1Q Tunneling** – Configures QinQ tunneling to maintain customer-specific VLAN and Layer 2 protocol configurations across a service provider network, even when different customers use the same internal VLAN IDs.
- ◆ **Protocol VLANs²** – Configures VLAN groups based on specified protocols.
- ◆ **IP Subnet VLANs²** – Maps untagged ingress frames to a specified VLAN if the source address is found in the IP subnet-to-VLAN mapping table.
- ◆ **MAC-based VLANs²** – Maps untagged ingress frames to a specified VLAN if the source MAC address is found in the IP MAC address-to-VLAN mapping table.
- ◆ **VLAN Mirroring** – Mirrors traffic from one or more source VLANs to a target port.

IEEE 802.1Q VLANs

In large networks, routers are used to isolate broadcast traffic for each subnet into separate domains. This switch provides a similar service at Layer 2 by using VLANs to organize any group of network nodes into separate broadcast domains. VLANs confine broadcast traffic to the originating group, and can eliminate broadcast storms in large networks. This also provides a more secure and cleaner network environment.

An IEEE 802.1Q VLAN is a group of ports that can be located anywhere in the network, but communicate as though they belong to the same physical segment.

VLANs help to simplify network management by allowing you to move devices to a new VLAN without having to change any physical connections. VLANs can be easily organized to reflect departmental groups (such as Marketing or R&D), usage groups (such as e-mail), or multicast groups (used for multimedia applications such as video conferencing).

2. If a packet matches the rules defined by more than one of these functions, only one of them is applied, with the precedence being MAC-based, IP subnet-based, protocol-based, and then native port-based.

VLANs provide greater network efficiency by reducing broadcast traffic, and allow you to make network changes without having to update IP addresses or IP subnets. VLANs inherently provide a high level of network security since traffic must pass through a configured Layer 3 link to reach a different VLAN.

This switch supports the following VLAN features:

- ◆ Up to 4094 VLANs based on the IEEE 802.1Q standard
- ◆ Distributed VLAN learning across multiple switches using explicit or implicit tagging and GVRP protocol
- ◆ Port overlapping, allowing a port to participate in multiple VLANs
- ◆ End stations can belong to multiple VLANs
- ◆ Passing traffic between VLAN-aware and VLAN-unaware devices
- ◆ Priority tagging

Assigning Ports to VLANs

Before enabling VLANs for the switch, you must first assign each port to the VLAN group(s) in which it will participate. By default all ports are assigned to VLAN 1 as untagged ports. Add a port as a tagged port if you want it to carry traffic for one or more VLANs, and any intermediate network devices or the host at the other end of the connection supports VLANs. Then assign ports on the other VLAN-aware network devices along the path that will carry this traffic to the same VLAN(s), either manually or dynamically using GVRP. However, if you want a port on this switch to participate in one or more VLANs, but none of the intermediate network devices nor the host at the other end of the connection supports VLANs, then you should add this port to the VLAN as an untagged port.



NOTE: VLAN-tagged frames can pass through VLAN-aware or VLAN-unaware network interconnection devices, but the VLAN tags should be stripped off before passing it on to any end-node host that does not support VLAN tagging.

Figure 66: VLAN Compliant and VLAN Non-compliant Devices

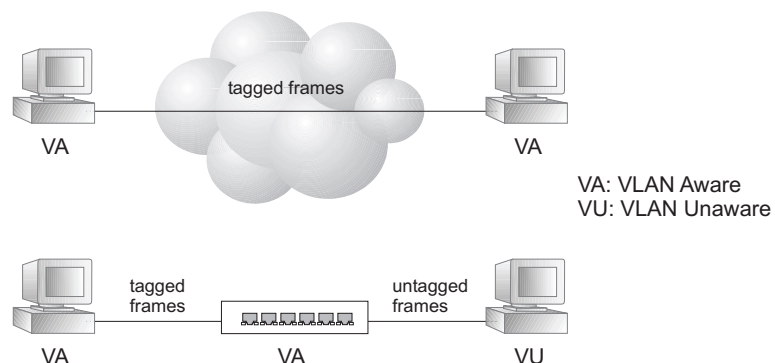

VLAN Classification – When the switch receives a frame, it classifies the frame in one of two ways. If the frame is untagged, the switch assigns the frame to an associated VLAN (based on the default VLAN ID of the receiving port). But if the frame is tagged, the switch uses the tagged VLAN ID to identify the port broadcast domain of the frame.

Port Overlapping – Port overlapping can be used to allow access to commonly shared network resources among different VLAN groups, such as file servers or printers. Note that if you implement VLANs which do not overlap, but still need to communicate, you can connect them by enabled routing on this switch.

Untagged VLANs – Untagged VLANs are typically used to reduce broadcast traffic and to increase security. A group of network users assigned to a VLAN form a broadcast domain that is separate from other VLANs configured on the switch. Packets are forwarded only between ports that are designated for the same VLAN. Untagged VLANs can be used to manually isolate user groups or subnets. However, you should use IEEE 802.3 tagged VLANs with GVRP whenever possible to fully automate VLAN registration.

Automatic VLAN Registration – GVRP (GARP VLAN Registration Protocol) defines a system whereby the switch can automatically learn the VLANs to which each end station should be assigned. If an end station (or its network adapter) supports the IEEE 802.1Q VLAN protocol, it can be configured to broadcast a message to your network indicating the VLAN groups it wants to join. When this switch receives these messages, it will automatically place the receiving port in the specified VLANs, and then forward the message to all other ports. When the message arrives at another switch that supports GVRP, it will also place the receiving port in the specified VLANs, and pass the message on to all other ports. VLAN requirements are propagated in this way throughout the network. This allows GVRP-compliant devices to be automatically configured for VLAN groups based solely on end station requests.

To implement GVRP in a network, first add the host devices to the required VLANs (using the operating system or other application software), so that these VLANs can be propagated onto the network. For both the edge switches attached directly to these hosts, and core switches in the network, enable GVRP on the links between these devices. You should also determine security boundaries in the network and disable GVRP on the boundary ports to prevent advertisements from being propagated, or forbid those ports from joining restricted VLANs.



NOTE: If you have host devices that do not support GVRP, you should configure static or untagged VLANs for the switch ports connected to these devices (as described in ["Adding Static Members to VLANs" on page 205](#)). But you can still enable GVRP on these edge switches, as well as on the core switches in the network.

Figure 67: Using GVRP

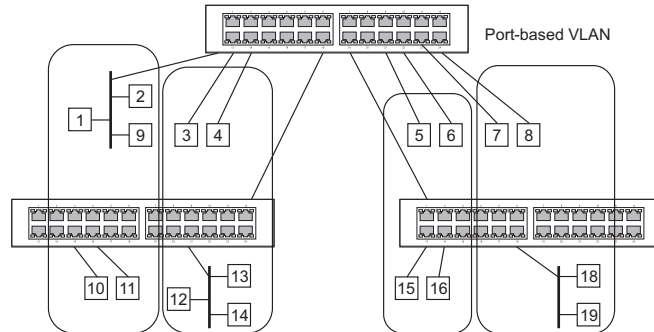

Forwarding Tagged/Untagged Frames

If you want to create a small port-based VLAN for devices attached directly to a single switch, you can assign ports to the same untagged VLAN. However, to participate in a VLAN group that crosses several switches, you should create a VLAN for that group and enable tagging on all ports.

Ports can be assigned to multiple tagged or untagged VLANs. Each port on the switch is therefore capable of passing tagged or untagged frames. When forwarding a frame from this switch along a path that contains any VLAN-aware devices, the switch should include VLAN tags. When forwarding a frame from this switch along a path that does not contain any VLAN-aware devices (including the destination host), the switch must first strip off the VLAN tag before forwarding the frame. When the switch receives a tagged frame, it will pass this frame onto the VLAN(s) indicated by the frame tag. However, when this switch receives an untagged frame from a VLAN-unaware device, it first decides where to forward the frame, and then inserts a VLAN tag reflecting the ingress port's default VID.

CONFIGURING VLAN GROUPS

Use the VLAN > Static (Add) page to create or remove VLAN groups, set administrative status, or specify Remote VLAN type (see ["Configuring Remote Port Mirroring" on page 162](#)). To propagate information about VLAN groups used on this switch to external network devices, you must specify a VLAN ID for each of these groups.

CLI REFERENCES

- ◆ ["Editing VLAN Groups" on page 1155](#)

PARAMETERS

These parameters are displayed:

Add

- ◆ **VLAN ID** – ID of VLAN or range of VLANs (1-4094).

Up to 4094 VLAN groups can be defined. VLAN 1 is the default untagged VLAN.

VLAN 4093 is dedicated for [Switch Clustering](#). Configuring this VLAN for other purposes may cause problems in the Clustering operation.

- ◆ **Status** – Enables or disables the specified VLAN.
- ◆ **Remote VLAN** – Reserves this VLAN for RSPAN (see ["Configuring Remote Port Mirroring" on page 162](#)).

Modify

- ◆ **VLAN ID** – ID of configured VLAN (1-4094).
- ◆ **VLAN Name** – Name of the VLAN (1 to 32 characters).
- ◆ **Status** – Enables or disables the specified VLAN.
- ◆ **L3 Interface** – Sets the interface to support Layer 3 configuration, and reserves memory space required to maintain additional information about this interface type. This parameter must be enabled before you can assign an IP address to a VLAN (see ["Setting the Switch's IP Address \(IP Version 4\)" on page 639](#)).

Show

- ◆ **VLAN ID** – ID of configured VLAN.
- ◆ **VLAN Name** – Name of the VLAN.
- ◆ **Status** – Operational status of configured VLAN.
- ◆ **Remote VLAN** – Shows if RSPAN is enabled on this VLAN (see ["Configuring Remote Port Mirroring" on page 162](#)).
- ◆ **L3 Interface** – Shows if the interface supports Layer 3 configuration.

WEB INTERFACE

To create VLAN groups:

1. Click VLAN, Static.
2. Select Add from the Action list.
3. Enter a VLAN ID or range of IDs.
4. Check Status to configure the VLAN as operational.
5. Specify whether the VLANs are to be used for remote port mirroring.
6. Click Apply.

Figure 68: Creating Static VLANs

The screenshot shows the 'VLAN > Static' configuration page. The 'Action' dropdown is set to 'Add'. The 'VLAN ID (1-4094)' field contains '2'. The 'Status' checkbox is checked and labeled 'Enabled'. The 'Remote VLAN' checkbox is unchecked. 'Apply' and 'Revert' buttons are at the bottom right.

To modify the configuration settings for VLAN groups:

1. Click VLAN, Static.
2. Select Modify from the Action list.
3. Select the identifier of a configured VLAN.
4. Modify the VLAN name, operational status, or Layer 3 Interface status as required.
5. Click Apply.

Figure 69: Modifying Settings for Static VLANs

The screenshot shows the 'VLAN > Static' configuration page. The 'Action' dropdown is set to 'Modify'. The 'VLAN ID (1-4093)' dropdown is set to '2'. The 'VLAN Name' field contains 'R&D'. The 'Status' and 'L3 Interface' checkboxes are both checked and labeled 'Enabled'. 'Apply' and 'Revert' buttons are at the bottom right.

To show the configuration settings for VLAN groups:

1. Click VLAN, Static.
2. Select Show from the Action list.

Figure 70: Showing Static VLANs

The screenshot shows the 'VLAN > Static' configuration page. The 'Action' dropdown is set to 'Show'. Below the form is a table titled 'Static VLAN List Total: 2'. The table has columns for 'VLAN ID', 'VLAN Name', 'Status', 'Remote VLAN', and 'L3 Interface'. There are two rows of data. 'Delete' and 'Revert' buttons are at the bottom right.

<input type="checkbox"/>	VLAN ID	VLAN Name	Status	Remote VLAN	L3 Interface
<input type="checkbox"/>	1	DefaultVlan	Enabled	Disabled	Enabled
<input type="checkbox"/>	2	R&D	Enabled	Disabled	Enabled

ADDING STATIC MEMBERS TO VLANs

Use the VLAN > Static (Edit Member by VLAN, Edit Member by Interface, or Edit Member by Interface Range) pages to configure port members for the selected VLAN index, interface, or a range of interfaces. Use the menus for editing port members to configure the VLAN behavior for specific interfaces, including the mode of operation (Hybrid or 1Q Trunk), the default VLAN identifier (PVID), accepted frame types, and ingress filtering. Assign ports as tagged if they are connected to 802.1Q VLAN compliant devices, or untagged if they are not connected to any VLAN-aware devices. Or configure a port as forbidden to prevent the switch from automatically adding it to a VLAN via the GVRP protocol.

CLI REFERENCES

- ◆ ["Configuring VLAN Interfaces" on page 1157](#)
- ◆ ["Displaying VLAN Information" on page 1164](#)

PARAMETERS

These parameters are displayed:

Edit Member by VLAN

- ◆ **VLAN** – ID of configured VLAN (1-4094).
- ◆ **Interface** – Displays a list of ports or trunks.
- ◆ **Port** – Port Identifier. (Range: 1-28/52)
- ◆ **Trunk** – Trunk Identifier. (Range: 1-16)
- ◆ **Mode** – Indicates VLAN membership mode for an interface. (Default: Hybrid)
 - **Access** - Sets the port to operate as an untagged interface. The port transmits and receives untagged frames on a single VLAN only. Access mode is mutually exclusive with VLAN trunking (see ["VLAN Trunking" on page 196](#)). If VLAN trunking is enabled on an interface, then that interface cannot be set to access mode, and vice versa.
 - **Hybrid** – Specifies a hybrid VLAN interface. The port may transmit tagged or untagged frames.
 - **1Q Trunk** – Specifies a port as an end-point for a VLAN trunk. A trunk is a direct link between two switches, so the port transmits tagged frames that identify the source VLAN. Note that frames belonging to the port's default VLAN (i.e., associated with the PVID) are also transmitted as tagged frames.
- ◆ **PVID** – VLAN ID assigned to untagged frames received on the interface. (Default: 1)

When using Access mode, and an interface is assigned to a new VLAN, its PVID is automatically set to the identifier for that VLAN. When using Hybrid mode, the PVID for an interface can be set to any VLAN for which it is an untagged member.

- ◆ **Acceptable Frame Type** – Sets the interface to accept all frame types, including tagged or untagged frames, or only tagged frames. When set to receive all frame types, any received frames that are untagged are assigned to the default VLAN. (Options: All, Tagged; Default: All)
- ◆ **Ingress Filtering** – Determines how to process frames tagged for VLANs for which the ingress port is not a member. (Default: Disabled)
 - Ingress filtering only affects tagged frames.
 - If ingress filtering is disabled and a port receives frames tagged for VLANs for which it is not a member, these frames will be flooded to all other ports (except for those VLANs explicitly forbidden on this port).
 - If ingress filtering is enabled and a port receives frames tagged for VLANs for which it is not a member, these frames will be discarded.
 - Ingress filtering does not affect VLAN independent BPDU frames, such as GVRP or STP. However, they do affect VLAN dependent BPDU frames, such as GMRP.
- ◆ **Membership Type** – Select VLAN membership for each interface by marking the appropriate radio button for a port or trunk:
 - **Tagged:** Interface is a member of the VLAN. All packets transmitted by the port will be tagged, that is, carry a tag and therefore carry VLAN or CoS information.
 - **Untagged:** Interface is a member of the VLAN. All packets transmitted by the port will be untagged, that is, not carry a tag and therefore not carry VLAN or CoS information. Note that an interface must be assigned to at least one group as an untagged port.
 - **Forbidden:** Interface is forbidden from automatically joining the VLAN via GVRP. For more information, see “Automatic VLAN Registration” on page 201.
 - **None:** Interface is not a member of the VLAN. Packets associated with this VLAN will not be transmitted by the interface.



NOTE: VLAN 1 is the default untagged VLAN containing all ports on the switch.

Edit Member by Interface

All parameters are the same as those described under the preceding section for Edit Member by VLAN.

Edit Member by Interface Range

All parameters are the same as those described under the earlier section for Edit Member by VLAN, except for the items shown below.

- ◆ **Port Range** – Displays a list of ports. (Range: 1-28/52)
- ◆ **Trunk Range** – Displays a list of ports. (Range: 1-16)



NOTE: The PVID, acceptable frame type, and ingress filtering parameters for each interface within the specified range must be configured on either the Edit Member by VLAN or Edit Member by Interface page.

WEB INTERFACE

To configure static members by the VLAN index:

1. Click VLAN, Static.
2. Select Edit Member by VLAN from the Action list.
3. Set the Interface type to display as Port or Trunk.
4. Modify the settings for any interface as required.
5. Click Apply.

Figure 71: Configuring Static Members by VLAN Index

Port	Mode	PVID	Acceptable Frame Type	Ingress Filtering	Membership Type			
					Tagged	Untagged	Forbidden	None
1	Hybrid	1	All	<input type="checkbox"/> Enabled	<input type="radio"/>	<input checked="" type="radio"/>	<input type="radio"/>	<input type="radio"/>
2	Hybrid	1	All	<input type="checkbox"/> Enabled	<input type="radio"/>	<input checked="" type="radio"/>	<input type="radio"/>	<input type="radio"/>
3	Hybrid	1	All	<input type="checkbox"/> Enabled	<input type="radio"/>	<input checked="" type="radio"/>	<input type="radio"/>	<input type="radio"/>
4	Hybrid	1	All	<input type="checkbox"/> Enabled	<input type="radio"/>	<input checked="" type="radio"/>	<input type="radio"/>	<input type="radio"/>
5	Hybrid	1	All	<input type="checkbox"/> Enabled	<input type="radio"/>	<input checked="" type="radio"/>	<input type="radio"/>	<input type="radio"/>

To configure static members by interface:

1. Click VLAN, Static.
2. Select Edit Member by Interface from the Action list.
3. Select a port or trunk configure.
4. Modify the settings for any interface as required.

5. Click Apply.

Figure 72: Configuring Static VLAN Members by Interface

VLAN > Static

Action:

Interface: Port Trunk

Mode:

PVID:

Acceptable Frame Type:

Ingress Filtering: Enabled

Static VLAN Membership List Total: 4

VLAN	Membership Type			
	Tagged	Untagged	Forbidden	None
1	<input checked="" type="radio"/>	<input type="radio"/>	<input type="radio"/>	<input type="radio"/>
2	<input type="radio"/>	<input type="radio"/>	<input type="radio"/>	<input checked="" type="radio"/>
3	<input type="radio"/>	<input type="radio"/>	<input type="radio"/>	<input checked="" type="radio"/>
4	<input type="radio"/>	<input type="radio"/>	<input type="radio"/>	<input checked="" type="radio"/>

To configure static members by interface range:

1. Click VLAN, Static.
2. Select Edit Member by Interface Range from the Action list.
3. Set the Interface type to display as Port or Trunk.
4. Enter an interface range.
5. Modify the VLAN parameters as required. Remember that the PVID, acceptable frame type, and ingress filtering parameters for each interface within the specified range must be configured on either the Edit Member by VLAN or Edit Member by Interface page.
6. Click Apply.

Figure 73: Configuring Static VLAN Members by Interface Range

VLAN > Static

Action:

Interface: Port Trunk

Port Range (1-52): -

Mode:

VLAN ID (1-4093): -

Membership Type: Tagged Untagged Forbidden None

**CONFIGURING
DYNAMIC VLAN
REGISTRATION**

Use the VLAN > Dynamic page to enable GVRP globally on the switch, or to enable GVRP and adjust the protocol timers per interface.

CLI REFERENCES

- ◆ ["GVRP and Bridge Extension Commands" on page 1150](#)
- ◆ ["Configuring VLAN Interfaces" on page 1157](#)

PARAMETERS

These parameters are displayed:

Configure General

- ◆ **GVRP Status** – GVRP defines a way for switches to exchange VLAN information in order to register VLAN members on ports across the network. VLANs are dynamically configured based on join messages issued by host devices and propagated throughout the network. GVRP must be enabled to permit automatic VLAN registration, and to support VLANs which extend beyond the local switch. (Default: Disabled)

Configure Interface

- ◆ **Interface** – Displays a list of ports or trunks.
- ◆ **Port** – Port Identifier. (Range: 1-28/52)
- ◆ **Trunk** – Trunk Identifier. (Range: 1-16)
- ◆ **GVRP Status** – Enables/disables GVRP for the interface. GVRP must be globally enabled for the switch before this setting can take effect (using the Configure General page). When disabled, any GVRP packets received on this port will be discarded and no GVRP registrations will be propagated from other ports. (Default: Disabled)
GVRP cannot be enabled for ports set to Access mode (see ["Adding Static Members to VLANs" on page 205](#)).

- ◆ **GARP Timers** – Timer settings must follow this rule:
 $2 \times (\text{join timer}) < \text{leave timer} < \text{leaveAll timer}$
 - **Join** – The interval between transmitting requests/queries to participate in a VLAN group. (Range: 20-1000 centiseconds; Default: 20 centiseconds)
 - **Leave** – The interval a port waits before leaving a VLAN group. This time should be set to more than twice the join time. This ensures that after a Leave or LeaveAll message has been issued, the applicants can rejoin before the port actually leaves the group. (Range: 60-3000 centiseconds; Default: 60 centiseconds)
 - **LeaveAll** – The interval between sending out a LeaveAll query message for VLAN group participants and the port leaving the group. This interval should be considerably larger than the Leave Time to minimize the amount of traffic generated by nodes rejoining

the group. (Range: 500-18000 centiseconds; Default: 1000 centiseconds)

Show Dynamic VLAN – Show VLAN

VLAN ID – Identifier of a VLAN this switch has joined through GVRP.

VLAN Name – Name of a VLAN this switch has joined through GVRP.

Status – Indicates if this VLAN is currently operational.
(Display Values: Enabled, Disabled)

Show Dynamic VLAN – Show VLAN Member

- ◆ **VLAN** – Identifier of a VLAN this switch has joined through GVRP.
- ◆ **Interface** – Displays a list of ports or trunks which have joined the selected VLAN through GVRP.

WEB INTERFACE

To configure GVRP on the switch:

1. Click VLAN, Dynamic.
2. Select Configure General from the Step list.
3. Enable or disable GVRP.
4. Click Apply.

Figure 74: Configuring Global Status of GVRP

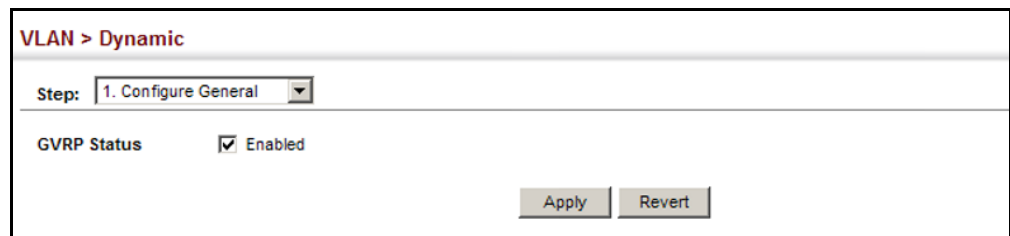

To configure GVRP status and timers on a port or trunk:

1. Click VLAN, Dynamic.
2. Select Configure Interface from the Step list.
3. Set the Interface type to display as Port or Trunk.
4. Modify the GVRP status or timers for any interface.
5. Click Apply.

Figure 75: Configuring GVRP for an Interface

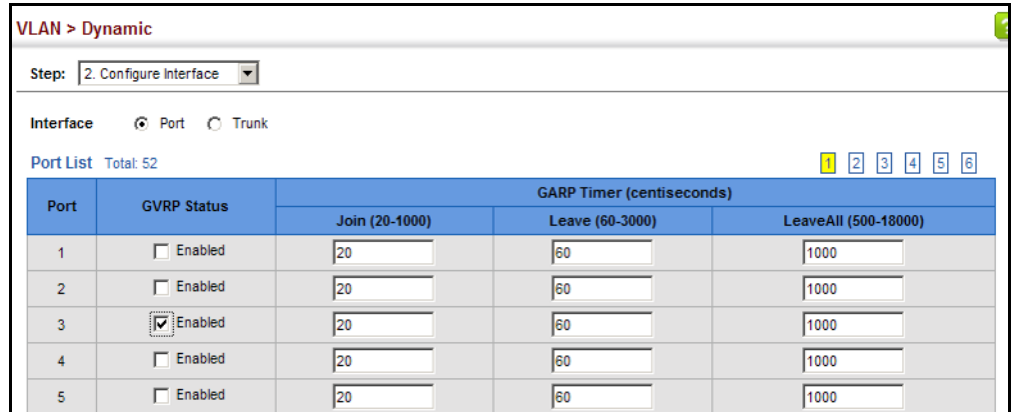

To show the dynamic VLAN joined by this switch:

1. Click VLAN, Dynamic.
2. Select Show Dynamic VLAN from the Step list.
3. Select Show VLAN from the Action list.

Figure 76: Showing Dynamic VLANs Registered on the Switch

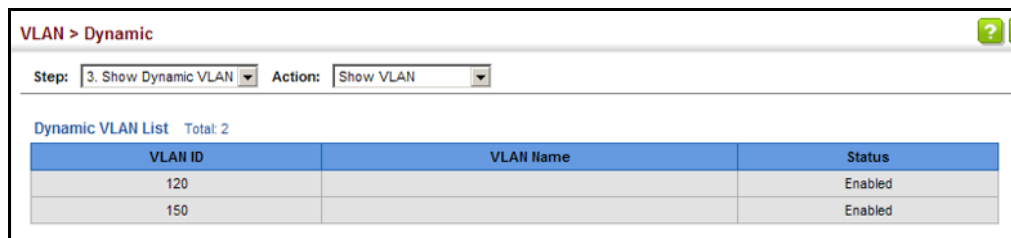

To show the members of a dynamic VLAN:

1. Click VLAN, Dynamic.
2. Select Show Dynamic VLAN from the Step list.
3. Select Show VLAN Members from the Action list.

Figure 77: Showing the Members of a Dynamic VLAN

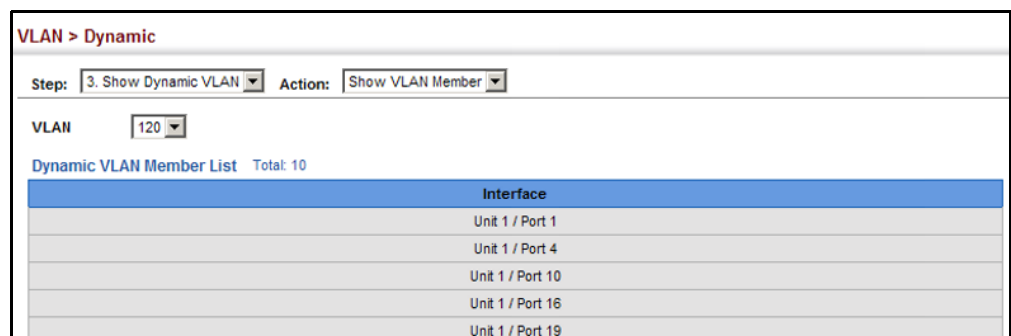

IEEE 802.1Q TUNNELING

IEEE 802.1Q Tunneling (QinQ) is designed for service providers carrying traffic for multiple customers across their networks. QinQ tunneling is used to maintain customer-specific VLAN and Layer 2 protocol configurations even when different customers use the same internal VLAN IDs. This is accomplished by inserting Service Provider VLAN (SPVLAN) tags into the customer's frames when they enter the service provider's network, and then stripping the tags when the frames leave the network.

A service provider's customers may have specific requirements for their internal VLAN IDs and number of VLANs supported. VLAN ranges required by different customers in the same service-provider network might easily overlap, and traffic passing through the infrastructure might be mixed. Assigning a unique range of VLAN IDs to each customer would restrict customer configurations, require intensive processing of VLAN mapping tables, and could easily exceed the maximum VLAN limit of 4096.

QinQ tunneling uses a single Service Provider VLAN (SPVLAN) for customers who have multiple VLANs. Customer VLAN IDs are preserved and traffic from different customers is segregated within the service provider's network even when they use the same customer-specific VLAN IDs. QinQ tunneling expands VLAN space by using a VLAN-in-VLAN hierarchy, preserving the customer's original tagged packets, and adding SPVLAN tags to each frame (also called double tagging).

A port configured to support QinQ tunneling must be set to tunnel port mode. The Service Provider VLAN (SPVLAN) ID for the specific customer must be assigned to the QinQ tunnel access port on the edge switch where the customer traffic enters the service provider's network. Each customer requires a separate SPVLAN, but this VLAN supports all of the customer's internal VLANs. The QinQ tunnel uplink port that passes traffic from the edge switch into the service provider's metro network must also be added to this SPVLAN. The uplink port can be added to multiple SPVLANs to carry inbound traffic for different customers onto the service provider's network.

When a double-tagged packet enters another trunk port in an intermediate or core switch in the service provider's network, the outer tag is stripped for packet processing. When the packet exits another trunk port on the same core switch, the same SPVLAN tag is again added to the packet.

When a packet enters the trunk port on the service provider's egress switch, the outer tag is again stripped for packet processing. However, the SPVLAN tag is not added when it is sent out the tunnel access port on the edge switch into the customer's network. The packet is sent as a normal IEEE 802.1Q-tagged frame, preserving the original VLAN numbers used in the customer's network.

Figure 78: QinQ Operational Concept

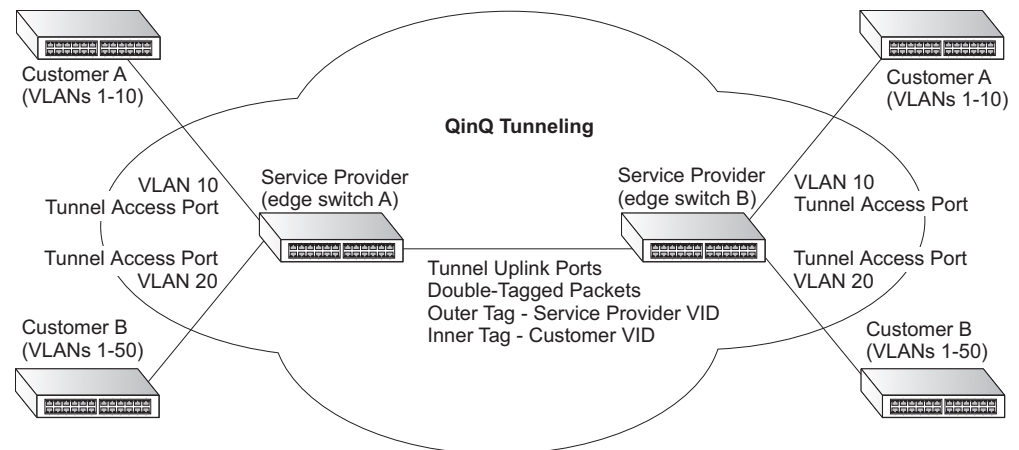

Layer 2 Flow for Packets Coming into a Tunnel Access Port

A QinQ tunnel port may receive either tagged or untagged packets. No matter how many tags the incoming packet has, it is treated as tagged packet.

The ingress process does source and destination lookups. If both lookups are successful, the ingress process writes the packet to memory. Then the egress process transmits the packet. Packets entering a QinQ tunnel port are processed in the following manner:

1. An SPVLAN tag is added to all outbound packets on the SPVLAN interface, no matter how many tags they already have. The switch constructs and inserts the outer tag (SPVLAN) into the packet based on the default VLAN ID and Tag Protocol Identifier (TPID, that is, the ether-type of the tag), unless otherwise defined as described under ["Creating CVLAN to SPVLAN Mapping Entries" on page 217](#). The priority of the inner tag is copied to the outer tag if it is a tagged or priority tagged packet.
2. After successful source and destination lookup, the ingress process sends the packet to the switching process with two tags. If the incoming packet is untagged, the outer tag is an SPVLAN tag, and the inner tag is a dummy tag (8100 0000). If the incoming packet is tagged, the outer tag is an SPVLAN tag, and the inner tag is a CVLAN tag.
3. After packet classification through the switching process, the packet is written to memory with one tag (an outer tag) or with two tags (both an outer tag and inner tag).
4. The switch sends the packet to the proper egress port.
5. If the egress port is an untagged member of the SPVLAN, the outer tag will be stripped. If it is a tagged member, the outgoing packets will have two tags.

Layer 2 Flow for Packets Coming into a Tunnel Uplink Port

An uplink port receives one of the following packets:

- ◆ Untagged
- ◆ One tag (CVLAN or SPVLAN)
- ◆ Double tag (CVLAN + SPVLAN)

The ingress process does source and destination lookups. If both lookups are successful, the ingress process writes the packet to memory. Then the egress process transmits the packet. Packets entering a QinQ uplink port are processed in the following manner:

1. If incoming packets are untagged, the PVID VLAN native tag is added.
2. If the ether-type of an incoming packet (single or double tagged) is not equal to the TPID of the uplink port, the VLAN tag is determined to be a Customer VLAN (CVLAN) tag. The uplink port's PVID VLAN native tag is added to the packet. This outer tag is used for learning and switching packets within the service provider's network. The TPID must be configured on a per port basis, and the verification cannot be disabled.
3. If the ether-type of an incoming packet (single or double tagged) is equal to the TPID of the uplink port, no new VLAN tag is added. If the uplink port is not the member of the outer VLAN of the incoming packets, the packet will be dropped when ingress filtering is enabled. If ingress filtering is not enabled, the packet will still be forwarded. If the VLAN is not listed in the VLAN table, the packet will be dropped.
4. After successful source and destination lookups, the packet is double tagged. The switch uses the TPID of 0x8100 to indicate that an incoming packet is double-tagged. If the outer tag of an incoming double-tagged packet is equal to the port TPID and the inner tag is 0x8100, it is treated as a double-tagged packet. If a single-tagged packet has 0x8100 as its TPID, and port TPID is not 0x8100, a new VLAN tag is added and it is also treated as double-tagged packet.
5. If the destination address lookup fails, the packet is sent to all member ports of the outer tag's VLAN.
6. After packet classification, the packet is written to memory for processing as a single-tagged or double-tagged packet.
7. The switch sends the packet to the proper egress port.
8. If the egress port is an untagged member of the SPVLAN, the outer tag will be stripped. If it is a tagged member, the outgoing packet will have two tags.

Configuration Limitations for QinQ

- ◆ The native VLAN of uplink ports should not be used as the SPVLAN. If the SPVLAN is the uplink port's native VLAN, the uplink port must be an untagged member of the SPVLAN. Then the outer SPVLAN tag will be stripped when the packets are sent out. Another reason is that it causes non-customer packets to be forwarded to the SPVLAN.
- ◆ Static trunk port groups are compatible with QinQ tunnel ports as long as the QinQ configuration is consistent within a trunk port group.
- ◆ The native VLAN (VLAN 1) is not normally added to transmitted frames. Avoid using VLAN 1 as an SPVLAN tag for customer traffic to reduce the risk of misconfiguration. Instead, use VLAN 1 as a management VLAN instead of a data VLAN in the service provider network.
- ◆ There are some inherent incompatibilities between Layer 2 and Layer 3 switching:
 - Tunnel ports do not support IP Access Control Lists.
 - Layer 3 Quality of Service (QoS) and other QoS features containing Layer 3 information are not supported on tunnel ports.
 - Spanning tree bridge protocol data unit (BPDU) filtering is automatically disabled on a tunnel port.

General Configuration Guidelines for QinQ

1. Enable Tunnel Status, and set the Tag Protocol Identifier (TPID) value of the tunnel access port (in the Ethernet Type field. This step is required if the attached client is using a nonstandard 2-byte ethertype to identify 802.1Q tagged frames. The default ethertype value is 0x8100. (See ["Enabling QinQ Tunneling on the Switch" on page 216.](#))
2. Create a Service Provider VLAN, also referred to as an SPVLAN (see ["Configuring VLAN Groups" on page 202.](#))
3. Configure the QinQ tunnel access port to Access mode (see ["Adding an Interface to a QinQ Tunnel" on page 219.](#))
4. Configure the QinQ tunnel access port to join the SPVLAN as an untagged member (see ["Adding Static Members to VLANs" on page 205.](#))
5. Configure the SPVLAN ID as the native VID on the QinQ tunnel access port (see ["Adding Static Members to VLANs" on page 205.](#))
6. Configure the QinQ tunnel uplink port to Uplink mode (see ["Adding an Interface to a QinQ Tunnel" on page 219.](#))
7. Configure the QinQ tunnel uplink port to join the SPVLAN as a tagged member (see ["Adding Static Members to VLANs" on page 205.](#))

ENABLING QINQ TUNNELING ON THE SWITCH

Use the VLAN > Tunnel (Configure Global) page to configure the switch to operate in IEEE 802.1Q (QinQ) tunneling mode, which is used for passing Layer 2 traffic across a service provider's metropolitan area network. You can also globally set the Tag Protocol Identifier (TPID) value of the tunnel port if the attached client is using a nonstandard 2-byte ethertype to identify 802.1Q tagged frames.

CLI REFERENCES

- ◆ ["Configuring IEEE 802.1Q Tunneling" on page 1165](#)

PARAMETERS

These parameters are displayed:

- ◆ **Tunnel Status** – Sets the switch to QinQ mode. (Default: Disabled)
- ◆ **Ethernet Type** – The Tag Protocol Identifier (TPID) specifies the ethertype of incoming packets on a tunnel port. (Range: hexadecimal 0800-FFFF; Default: 8100)

Use this field to set a custom 802.1Q ethertype value for the 802.1Q Tunnel TPID. This feature allows the switch to interoperate with third-party switches that do not use the standard 0x8100 ethertype to identify 802.1Q-tagged frames. For example, if 0x1234 is set as the custom 802.1Q ethertype on a trunk port, incoming frames containing that ethertype are assigned to the VLAN contained in the tag following the ethertype field, as they would be with a standard 802.1Q trunk. Frames arriving on the port containing any other ethertype are looked upon as untagged frames, and assigned to the native VLAN of that port.

The specified ethertype only applies to ports configured in Uplink mode (see ["Adding an Interface to a QinQ Tunnel" on page 219](#)). If the port is in normal mode, the TPID is always 8100. If the port is in Access mode, received packets are processed as untagged packets.

Avoid using well-known etherypes for the TPID unless you can eliminate all side effects. For example, setting the TPID to 0800 hexadecimal (which is used for IPv4) will interfere with management access through the web interface.

WEB INTERFACE

To enable QinQ Tunneling on the switch:

1. Click VLAN, Tunnel.
2. Select Configure Global from the Step list.
3. Enable Tunnel Status, and specify the TPID if a client attached to a tunnel port is using a non-standard ethertype to identify 802.1Q tagged frames.
4. Click Apply.

Figure 79: Enabling QinQ Tunneling

The screenshot shows a web-based configuration interface for VLAN > Tunnel. At the top, it says 'VLAN > Tunnel'. Below that, there is a 'Step:' dropdown menu set to '1. Configure Global'. The main configuration area has two fields: 'Tunnel Status' with an unchecked checkbox labeled 'Enabled', and 'Ethernet Type' with a text input field containing '100'. Below the input field is a note: '(800-FFFF, hexadecimal value)'. At the bottom right, there are two buttons: 'Apply' and 'Revert'.

CREATING CVLAN TO SPVLAN MAPPING ENTRIES

Use the VLAN > Tunnel (Configure Service) page to create a CVLAN to SPVLAN mapping entry.

CLI REFERENCES

- ◆ ["switchport dot1q-tunnel service match cvid" on page 1168](#)

COMMAND USAGE

- ◆ The inner VLAN tag of a customer packet entering the edge router of a service provider's network is mapped to an outer tag indicating the service provider VLAN that will carry this traffic across the 802.1Q tunnel. By default, the outer tag is based on the default VID of the edge router's ingress port. This process is performed in a transparent manner as described under ["IEEE 802.1Q Tunneling" on page 212](#).
- ◆ When priority bits are found in the inner tag, these are also copied to the outer tag. This allows the service provider to differentiate service based on the indicated priority and appropriate methods of queue management at intermediate nodes across the tunnel.
- ◆ Rather than relying on standard service paths and priority queuing, QinQ VLAN mapping can be used to further enhance service by defining a set of differentiated service pathways to follow across the service provider's network for traffic arriving from specified inbound customer VLANs.
- ◆ Note that all customer interfaces should be configured as access interfaces (that is, a user-to-network interface) and service provider interfaces as uplink interfaces (that is, a network-to-network interface). Use the Configure Interface page described in the next section to set an interface to access or uplink mode.

PARAMETERS

These parameters are displayed:

- ◆ **Port** – Port identifier. (Range: 1-28/52)
- ◆ **Customer VLAN ID** – VLAN ID for the inner VLAN tag. (Range: 1-4094)

- ◆ **Service VLAN ID** – VLAN ID for the outer VLAN tag. (Range: 1-4094)

WEB INTERFACE

To configure a mapping entry:

1. Click VLAN, Tunnel.
2. Select Configure Service from the Step list.
3. Select Add from the Action list.
4. Select an interface from the Port list.
5. Specify the CVID to SVID mapping for packets exiting the specified port.
6. Click Apply.

Figure 80: Configuring CVLAN to SPVLAN Mapping Entries

VLAN > Tunnel

Step: 1. Configure Global

Tunnel Status Enabled

Ethernet Type
(800-FFFF, hexadecimal value)

Apply Revert

To show the mapping table:

1. Click VLAN, Tunnel.
2. Select Configure Service from the Step list.
3. Select Show from the Action list.
4. Select an interface from the Port list.

Figure 81: Showing CVLAN to SPVLAN Mapping Entries

VLAN > Tunnel

Step: 2. Configure Service Action: Show

Port 1

Tunnel Service Subscriptions List Total: 2

<input type="checkbox"/>	Customer VLAN ID	Service VLAN ID
<input type="checkbox"/>	1	1
<input type="checkbox"/>	2	200

Delete Revert

The preceding example sets the SVID to 99 in the outer tag for egress packets exiting port 1 when the packet's CVID is 2. For a more detailed example, see the [switchport dot1q-tunnel service match cvid](#) command.

ADDING AN INTERFACE TO A QINQ TUNNEL

Follow the guidelines in the preceding section to set up a QinQ tunnel on the switch. Then use the VLAN > Tunnel (Configure Interface) page to set the tunnel mode for any participating interface.

CLI REFERENCES

- ◆ ["Configuring IEEE 802.1Q Tunneling" on page 1165](#)

COMMAND USAGE

- ◆ Use the Configure Global page to set the switch to QinQ mode before configuring a tunnel access port or tunnel uplink port (see ["Enabling QinQ Tunneling on the Switch" on page 216](#)). Also set the Tag Protocol Identifier (TPID) value of the tunnel access port if the attached client is using a nonstandard 2-byte ethertype to identify 802.1Q tagged frames.
- ◆ Then use the Configure Interface page to set the access interface on the edge switch to Access mode, and set the uplink interface on the switch attached to the service provider network to Uplink mode.

PARAMETERS

These parameters are displayed:

- ◆ **Interface** – Displays a list of ports or trunks.
- ◆ **Port** – Port Identifier. (Range: 1-28/52)
- ◆ **Trunk** – Trunk Identifier. (Range: 1-16)
- ◆ **Mode** – Sets the VLAN membership mode of the port.
 - **None** – The port operates in its normal VLAN mode. (This is the default.)
 - **Access** – Configures QinQ tunneling for a client access port to segregate and preserve customer VLAN IDs for traffic crossing the service provider network.
 - **Uplink** – Configures QinQ tunneling for an uplink port to another device within the service provider network.

WEB INTERFACE

To add an interface to a QinQ tunnel:

1. Click VLAN, Tunnel.
2. Select Configure Interface from the Step list.
3. Set the mode for any tunnel access port to Access and the tunnel uplink port to Uplink.

4. Click Apply.

Figure 82: Adding an Interface to a QinQ Tunnel

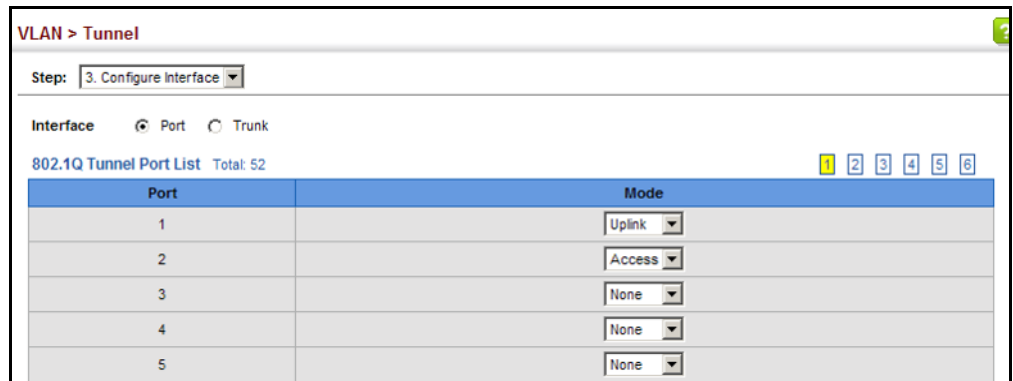

PROTOCOL VLANS

The network devices required to support multiple protocols cannot be easily grouped into a common VLAN. This may require non-standard devices to pass traffic between different VLANs in order to encompass all the devices participating in a specific protocol. This kind of configuration deprives users of the basic benefits of VLANs, including security and easy accessibility.

To avoid these problems, you can configure this switch with protocol-based VLANs that divide the physical network into logical VLAN groups for each required protocol. When a frame is received at a port, its VLAN membership can then be determined based on the protocol type being used by the inbound packets.

COMMAND USAGE

- ◆ To configure protocol-based VLANs, follow these steps:
 1. First configure VLAN groups for the protocols you want to use ([page 1155](#)). Although not mandatory, we suggest configuring a separate VLAN for each major protocol running on your network. Do not add port members at this time.
 2. Create a protocol group for each of the protocols you want to assign to a VLAN using the Configure Protocol (Add) page.
 3. Then map the protocol for each interface to the appropriate VLAN using the Configure Interface (Add) page.
- ◆ When MAC-based, IP subnet-based, or protocol-based VLANs are supported concurrently, priority is applied in this sequence, and then port-based VLANs last.

**CONFIGURING
PROTOCOL VLAN
GROUPS**

Use the VLAN > Protocol (Configure Protocol - Add) page to create protocol groups.

CLI REFERENCES

- ◆ "[protocol-vlan protocol-group \(Configuring Groups\)](#)" on page 1179

PARAMETERS

These parameters are displayed:

- ◆ **Frame Type** – Choose either Ethernet, RFC 1042, or LLC Other as the frame type used by this protocol.
- ◆ **Protocol Type** – Specifies the protocol type to match. The available options are IP, ARP, RARP and IPv6. If LLC Other is chosen for the Frame Type, the only available Protocol Type is IPX Raw.
- ◆ **Protocol Group ID** – Protocol Group ID assigned to the Protocol VLAN Group. (Range: 1-2147483647)



NOTE: Traffic which matches IP Protocol Ethernet Frames is mapped to the VLAN (VLAN 1) that has been configured with the switch's administrative IP. IP Protocol Ethernet traffic must not be mapped to another VLAN or you will lose administrative network connectivity to the switch. If lost in this manner, network access can be regained by removing the offending Protocol VLAN rule via the console. Alternately, the switch can be power-cycled, however all unsaved configuration changes will be lost.

WEB INTERFACE

To configure a protocol group:

1. Click VLAN, Protocol.
2. Select Configure Protocol from the Step list.
3. Select Add from the Action list.
4. Select an entry from the Frame Type list.
5. Select an entry from the Protocol Type list.
6. Enter an identifier for the protocol group.
7. Click Apply.

Figure 83: Configuring Protocol VLANs

VLAN > Protocol

Step: 1. Configure Protocol Action: Add

Frame Type: Ethernet

Protocol Type: 08 06 (ARP)

Protocol Group ID (1-2147483647): 1

Apply Revert

To configure a protocol group:

1. Click VLAN, Protocol.
2. Select Configure Protocol from the Step list.
3. Select Show from the Action list.

Figure 84: Displaying Protocol VLANs

VLAN > Protocol

Step: 1. Configure Protocol Action: Show

Protocol to Group Mapping Table Total: 5

<input type="checkbox"/>	Frame Type	Protocol Type	Protocol Group ID
<input type="checkbox"/>	Ethernet	08 06	1
<input type="checkbox"/>	Ethernet	80 35	2
<input type="checkbox"/>	RFC 1042	08 00	1
<input type="checkbox"/>	RFC 1042	80 35	3
<input type="checkbox"/>	LLC Other	FF FF	5

Delete Revert

**MAPPING
PROTOCOL GROUPS
TO INTERFACES**

Use the VLAN > Protocol (Configure Interface - Add) page to map a protocol group to a VLAN for each interface that will participate in the group.

CLI REFERENCES

- ◆ "[protocol-vlan protocol-group \(Configuring Interfaces\)](#)" on page 1180

COMMAND USAGE

- ◆ When creating a protocol-based VLAN, only assign interfaces using this configuration screen. If you assign interfaces using any of the other VLAN menus such as the VLAN Static table ([page 205](#)), these interfaces will admit traffic of any protocol type into the associated VLAN.

- ◆ When a frame enters a port that has been assigned to a protocol VLAN, it is processed in the following manner:
 - If the frame is tagged, it will be processed according to the standard rules applied to tagged frames.
 - If the frame is untagged and the protocol type matches, the frame is forwarded to the appropriate VLAN.
 - If the frame is untagged but the protocol type does not match, the frame is forwarded to the default VLAN for this interface.

PARAMETERS

These parameters are displayed:

- ◆ **Interface** – Displays a list of ports or trunks.
- ◆ **Port** – Port Identifier. (Range: 1-28/52)
- ◆ **Trunk** – Trunk Identifier. (Range: 1-16)
- ◆ **Protocol Group ID** – Protocol Group ID assigned to the Protocol VLAN Group. (Range: 1-2147483647)
- ◆ **VLAN ID** – VLAN to which matching protocol traffic is forwarded. (Range: 1-4094)
- ◆ **Priority** – The priority assigned to untagged ingress traffic. (Range: 0-7, where 7 is the highest priority; Default: 0)

WEB INTERFACE

To map a protocol group to a VLAN for a port or trunk:

1. Click VLAN, Protocol.
2. Select Configure Interface from the Step list.
3. Select Add from the Action list.
4. Select a port or trunk.
5. Enter the identifier for a protocol group.
6. Enter the corresponding VLAN to which the protocol traffic will be forwarded.
7. Set the priority to assign to untagged ingress frames.
8. Click Apply.

Figure 85: Assigning Interfaces to Protocol VLANs

The screenshot shows the 'VLAN > Protocol' configuration page. At the top, the breadcrumb is 'VLAN > Protocol'. Below it, there are two dropdown menus: 'Step: 2. Configure Interface' and 'Action: Add'. The main configuration area has the following fields:

- Interface:** Radio buttons for 'Port' (selected) and 'Trunk'. A dropdown menu next to 'Port' shows '1'.
- Protocol Group ID:** A dropdown menu showing '1'.
- VLAN ID (1-4094):** A text input field containing '1'.
- Priority (0-7):** A text input field containing '0'.

At the bottom right, there are two buttons: 'Apply' and 'Revert'.

To show the protocol groups mapped to a port or trunk:

1. Click VLAN, Protocol.
2. Select Configure Interface from the Step list.
3. Select Show from the Action list.
4. Select a port or trunk.

Figure 86: Showing the Interface to Protocol Group Mapping

The screenshot shows the 'VLAN > Protocol' configuration page with the 'Action' dropdown set to 'Show'. The 'Interface' section shows 'Port' selected with a dropdown menu showing '1'. Below this, there is a table titled 'Port To Protocol Group Mapping Table Total: 1'.

	Protocol Group ID	VLAN ID	Priority
<input type="checkbox"/>	1	2	0

At the bottom right, there are two buttons: 'Delete' and 'Revert'.

CONFIGURING IP SUBNET VLANs

Use the VLAN > IP Subnet page to configure IP subnet-based VLANs.

When using port-based classification, all untagged frames received by a port are classified as belonging to the VLAN whose VID (PVID) is associated with that port.

When IP subnet-based VLAN classification is enabled, the source address of untagged ingress frames are checked against the IP subnet-to-VLAN mapping table. If an entry is found for that subnet, these frames are assigned to the VLAN indicated in the entry. If no IP subnet is matched, the untagged frames are classified as belonging to the receiving port's VLAN ID (PVID).

CLI REFERENCES

- ◆ ["Configuring IP Subnet VLANs" on page 1182](#)

COMMAND USAGE

- ◆ Each IP subnet can be mapped to only one VLAN ID. An IP subnet consists of an IP address and a mask. The specified VLAN need not be an existing VLAN.
- ◆ When an untagged frame is received by a port, the source IP address is checked against the IP subnet-to-VLAN mapping table, and if an entry is found, the corresponding VLAN ID is assigned to the frame. If no mapping is found, the PVID of the receiving port is assigned to the frame.
- ◆ The IP subnet cannot be a broadcast or multicast IP address.
- ◆ When MAC-based, IP subnet-based, or protocol-based VLANs are supported concurrently, priority is applied in this sequence, and then port-based VLANs last.

PARAMETERS

These parameters are displayed:

- ◆ **IP Address** – The IP address for a subnet. Valid IP addresses consist of four decimal numbers, 0 to 255, separated by periods.
- ◆ **Subnet Mask** – This mask identifies the host address bits of the IP subnet.
- ◆ **VLAN** – VLAN to which matching IP subnet traffic is forwarded. (Range: 1-4094)
- ◆ **Priority** – The priority assigned to untagged ingress traffic. (Range: 0-7, where 7 is the highest priority; Default: 0)

WEB INTERFACE

To map an IP subnet to a VLAN:

1. Click VLAN, IP Subnet.
2. Select Add from the Action list.
3. Enter an address in the IP Address field.
4. Enter a mask in the Subnet Mask field.
5. Enter the identifier in the VLAN field. Note that the specified VLAN need not already be configured.
6. Enter a value to assign to untagged frames in the Priority field.
7. Click Apply.

Figure 87: Configuring IP Subnet VLANs

VLAN > IP Subnet

Action: Add

IP Address: 192.168.1.0

Subnet Mask: 255.255.255.0

VLAN (1-4093): 10

Priority (0-7):

Apply Revert

To show the configured IP subnet VLANs:

1. Click VLAN, IP Subnet.
2. Select Show from the Action list.

Figure 88: Showing IP Subnet VLANs

VLAN > IP Subnet

Action: Show

IP Subnet to VLAN Mapping Table Total: 1

	IP Address	Subnet Mask	VLAN	Priority
<input type="checkbox"/>	192.168.1.0	255.255.255.0	10	0

Delete Revert

CONFIGURING MAC-BASED VLANs

Use the VLAN > MAC-Based page to configure VLAN based on MAC addresses. The MAC-based VLAN feature assigns VLAN IDs to ingress untagged frames according to source MAC addresses.

When MAC-based VLAN classification is enabled, untagged frames received by a port are assigned to the VLAN which is mapped to the frame's source MAC address. When no MAC address is matched, untagged frames are assigned to the receiving port's native VLAN ID (PVID).

CLI REFERENCES

- ◆ ["Configuring MAC Based VLANs" on page 1184](#)

COMMAND USAGE

- ◆ The MAC-to-VLAN mapping applies to all ports on the switch.
- ◆ Source MAC addresses can be mapped to only one VLAN ID.
- ◆ Configured MAC addresses cannot be broadcast or multicast addresses.
- ◆ When MAC-based, IP subnet-based, or protocol-based VLANs are supported concurrently, priority is applied in this sequence, and then port-based VLANs last.

PARAMETERS

These parameters are displayed:

- ◆ **MAC Address** – A source MAC address which is to be mapped to a specific VLAN. The MAC address must be specified in the format xx-xx-xx-xx-xx-xx or xxxxxxxxxxxx.
- ◆ **Mask** – Identifies a range of MAC addresses.
(Range: 00-00-00-00-00-00 to FF-FF-FF-FF-FF-FF)

The binary equivalent mask matching the characters in the front of the first non-zero character must all be 1s (e.g., 111, i.e., it cannot be 101 or 001...). A mask for the MAC address: 00-50-6e-00-5f-b1 translated into binary:

MAC: 00000000-01010000-01101110-00000000-01011111-10110001
could be: 11111111-11xxxxxx-xxxxxxxx-xxxxxxxx-xxxxxxxx-xxxxxxxx

So the mask in hexadecimal for this example could be:
ff-fx-xx-xx-xx-xx/ff-c0-00-00-00-00/ff-e0-00-00-00-00
- ◆ **VLAN** – VLAN to which ingress traffic matching the specified source MAC address is forwarded. (Range: 1-4094)
- ◆ **Priority** – The priority assigned to untagged ingress traffic.
(Range: 0-7, where 7 is the highest priority; Default: 0)

WEB INTERFACE

To map a MAC address to a VLAN:

1. Click VLAN, MAC-Based.
2. Select Add from the Action list.
3. Enter an address in the MAC Address field, and a mask to indicate a range of addresses.
4. Enter an identifier in the VLAN field. Note that the specified VLAN need not already be configured.
5. Enter a value to assign to untagged frames in the Priority field.
6. Click Apply.

Figure 89: Configuring MAC-Based VLANs

The screenshot shows the 'VLAN > MAC-Based' configuration page. At the top, there is a breadcrumb 'VLAN > MAC-Based'. Below it, an 'Action:' dropdown menu is set to 'Add'. The form contains four input fields: 'MAC Address' with the value '00-50-6e-00-5f-b1', 'Mask' with 'ff-ff-ff-ff-ff', 'VLAN (1-4094)' with '2', and 'Priority (0-7)' with '0'. At the bottom right, there are 'Apply' and 'Revert' buttons.

To show the MAC addresses mapped to a VLAN:

1. Click VLAN, MAC-Based.
2. Select Show from the Action list.

Figure 90: Showing MAC-Based VLANs

The screenshot shows the 'VLAN > MAC-Based' configuration page with the 'Action:' dropdown set to 'Show'. Below the form, there is a table titled 'MAC-Based VLAN List' with a 'Total: 1' indicator. The table has five columns: a checkbox, 'MAC Address', 'Mask', 'VLAN', and 'Priority'. One row is visible with the following data: checkbox (unchecked), '00-50-6E-00-5F-B1', 'FF-FF-FF-FF-FF', '2', and '0'. At the bottom right, there are 'Delete' and 'Revert' buttons.

<input type="checkbox"/>	MAC Address	Mask	VLAN	Priority
<input type="checkbox"/>	00-50-6E-00-5F-B1	FF-FF-FF-FF-FF	2	0

CONFIGURING VLAN MIRRORING

Use the VLAN > Mirror (Add) page to mirror traffic from one or more source VLANs to a target port for real-time analysis. You can then attach a logic analyzer or RMON probe to the target port and study the traffic crossing the source VLAN(s) in a completely unobtrusive manner.

CLI REFERENCES

- ◆ ["Port Mirroring Commands" on page 1045](#)

COMMAND USAGE

- ◆ All active ports in a source VLAN are monitored for ingress traffic only.
- ◆ All VLAN mirror sessions must share the same target port, preferably one that is not a member of the source VLAN.
- ◆ When VLAN mirroring and port mirroring are both enabled, they must use the same target port.
- ◆ When VLAN mirroring and port mirroring are both enabled, the target port can receive a mirrored packet twice; once from the source mirror port and again from the source mirrored VLAN.
- ◆ The target port receives traffic from all monitored source VLANs and can become congested. Some mirror traffic may therefore be dropped from the target port.
- ◆ When mirroring VLAN traffic or packets based on a source MAC address (see ["Configuring MAC Address Mirroring" on page 237](#)), the target port cannot be set to the same target ports as that used for port mirroring (see ["Configuring Local Port Mirroring" on page 160](#)).
- ◆ When traffic matches the rules for both port mirroring, and for mirroring of VLAN traffic or packets based on a MAC address, the matching packets will not be sent to target port specified for port mirroring.

PARAMETERS

These parameters are displayed:

- ◆ **Source VLAN** – A VLAN whose traffic will be monitored. (Range: 1-4094)
- ◆ **Target Port** – The destination port that receives the mirrored traffic from the source VLAN. (Range: 1-28/52)

WEB INTERFACE

To configure VLAN mirroring:

1. Click VLAN, Mirror.
2. Select Add from the Action list.
3. Select the source VLAN, and select a target port.
4. Click Apply.

Figure 91: Configuring VLAN Mirroring

VLAN > Mirror

Action: Add

Source VLAN: 1

Target Port: 2

Apply Revert

To show the VLANs to be mirrored:

1. Click VLAN, Mirror.
2. Select Show from the Action list.

Figure 92: Showing the VLANs to Mirror

VLAN > Mirror

Action: Show

VLAN Mirror List Total: 1

	Source (VLAN)	Target (Unit/Port)
<input type="checkbox"/>	1	1/2

Delete Revert

Switches store the addresses for all known devices. This information is used to pass traffic directly between the inbound and outbound ports. All the addresses learned by monitoring traffic are stored in the dynamic address table. You can also manually configure static addresses that are bound to a specific port.

This chapter describes the following topics:

- ◆ [MAC Address Learning](#) – Enables or disables address learning on an interface.
- ◆ [Static MAC Addresses](#) – Configures static entries in the address table.
- ◆ [Address Aging Time](#) – Sets timeout for dynamically learned entries.
- ◆ [Dynamic Address Cache](#) – Shows dynamic entries in the address table.
- ◆ [MAC Address Mirroring](#) – Mirrors traffic matching a specified source address to a target port.

CONFIGURING MAC ADDRESS LEARNING

Use the [MAC Address > Learning Status](#) page to enable or disable MAC address learning on an interface.

CLI REFERENCES

- ◆ ["mac-learning" on page 890](#)

COMMAND USAGE

- ◆ When MAC address learning is disabled, the switch immediately stops learning new MAC addresses on the specified interface. Only incoming traffic with source addresses stored in the static address table (see ["Setting Static Addresses" on page 233](#)) will be accepted as authorized to access the network through that interface.
- ◆ Dynamic addresses stored in the address table when MAC address learning is disabled are flushed from the system, and no dynamic addresses are subsequently learned until MAC address learning has been re-enabled. Any device not listed in the static address table that attempts to use the interface after MAC learning has been disabled will be prevented from accessing the switch.

- ◆ Also note that MAC address learning cannot be disabled if any of the following conditions exist:
 - 802.1X Port Authentication has been globally enabled on the switch (see "Configuring 802.1X Global Settings" on page 389).
 - Security Status (see "Configuring Port Security" on page 385) is enabled on the same interface.

PARAMETERS

These parameters are displayed:

- ◆ **Interface** – Displays a list of ports or trunks.
- ◆ **Port** – Port Identifier. (Range: 1-28/52)
- ◆ **Trunk** – Trunk Identifier. (Range: 1-16)
- ◆ **Status** – The status of MAC address learning. (Default: Enabled)

WEB INTERFACE

To enable or disable MAC address learning:

1. Click MAC Address, Learning Status.
2. Set the learning status for any interface.
3. Click Apply.

Figure 93: Configuring MAC Address Learning

Port	Status
1	<input type="checkbox"/> Enabled
2	<input checked="" type="checkbox"/> Enabled
3	<input checked="" type="checkbox"/> Enabled
4	<input checked="" type="checkbox"/> Enabled
5	<input checked="" type="checkbox"/> Enabled

SETTING STATIC ADDRESSES

Use the MAC Address > Static page to configure static MAC addresses. A static address can be assigned to a specific interface on this switch. Static addresses are bound to the assigned interface and will not be moved. When a static address is seen on another interface, the address will be ignored and will not be written to the address table.

CLI REFERENCES

- ◆ ["mac-address-table static" on page 1086](#)

COMMAND USAGE

The static address for a host device can be assigned to a specific port within a specific VLAN. Use this command to add static addresses to the MAC Address Table. Static addresses have the following characteristics:

- ◆ Static addresses are bound to the assigned interface and will not be moved. When a static address is seen on another interface, the address will be ignored and will not be written to the address table.
- ◆ Static addresses will not be removed from the address table when a given interface link is down.
- ◆ A static address cannot be learned on another port until the address is removed from the table.

PARAMETERS

These parameters are displayed:

- ◆ **VLAN** – ID of configured VLAN. (Range: 1-4094)
- ◆ **Interface** – Port or trunk associated with the device assigned a static address.
- ◆ **MAC Address** – Physical address of a device mapped to this interface. Enter an address in the form of xx-xx-xx-xx-xx-xx or xxxxxxxxxxxx.
- ◆ **Static Status** – Sets the time to retain the specified address.
 - Delete-on-reset - Assignment lasts until the switch is reset.
 - Permanent - Assignment is permanent. (This is the default.)

WEB INTERFACE

To configure a static MAC address:

1. Click MAC Address, Static.
2. Select Add from the Action list.
3. Specify the VLAN, the port or trunk to which the address will be assigned, the MAC address, and the time to retain this entry.

4. Click Apply.

Figure 94: Configuring Static MAC Addresses

MAC Address > Static

Action: Add

VLAN: 1

Interface: Port 1

MAC Address: 00-12-cf-94-34-da

Static Status: Permanent

Apply Revert

To show the static addresses in MAC address table:

1. Click MAC Address, Static.
2. Select Show from the Action list.

Figure 95: Displaying Static MAC Addresses

MAC Address > Static

Action: Show

Static MAC Address to Interface Mapping Table Total: 2

	MAC Address	VLAN	Interface	Type	Life Time
<input type="checkbox"/>	00-00-0C-00-00-FD	1	CPU	CPU	Delete on Reset
<input type="checkbox"/>	00-12-CF-94-34-DA	1	Unit 1 / Port 1	Config	Permanent

Delete Revert

CHANGING THE AGING TIME

Use the MAC Address > Dynamic (Configure Aging) page to set the aging time for entries in the dynamic address table. The aging time is used to age out dynamically learned forwarding information.

CLI REFERENCES

- ◆ ["mac-address-table aging-time" on page 1085](#)

PARAMETERS

These parameters are displayed:

- ◆ **Aging Status** – Enables/disables the function.
- ◆ **Aging Time** – The time after which a learned entry is discarded. (Range: 10-844 seconds; Default: 300 seconds)

WEB INTERFACE

To set the aging time for entries in the dynamic address table:

1. Click MAC Address, Dynamic.
2. Select Configure Aging from the Action list.
3. Modify the aging status if required.
4. Specify a new aging time.
5. Click Apply.

Figure 96: Setting the Address Aging Time

The screenshot shows a web interface for configuring MAC address settings. At the top, it says "MAC Address > Dynamic". Below that, there is a dropdown menu for "Action" with "Configure Aging" selected. Underneath, there are two settings: "Aging Status" which is checked and set to "Enabled", and "Aging Time (10-844)" which is set to "300" with "sec" next to it. At the bottom right, there are two buttons: "Apply" and "Revert".

DISPLAYING THE DYNAMIC ADDRESS TABLE

Use the MAC Address > Dynamic (Show Dynamic MAC) page to display the MAC addresses learned by monitoring the source address for traffic entering the switch. When the destination address for inbound traffic is found in the database, the packets intended for that address are forwarded directly to the associated port. Otherwise, the traffic is flooded to all ports.

CLI REFERENCES

- ◆ ["show mac-address-table" on page 1087](#)

PARAMETERS

These parameters are displayed:

- ◆ **Sort Key** - You can sort the information displayed based on MAC address, VLAN or interface (port or trunk).
- ◆ **MAC Address** - Physical address associated with this interface.
- ◆ **VLAN** - ID of configured VLAN (1-4094).
- ◆ **Interface** - Indicates a port or trunk.
- ◆ **Type** - Shows that the entries in this table are learned.
- ◆ **Life Time** - Shows the time to retain the specified address.

WEB INTERFACE

To show the dynamic address table:

1. Click MAC Address, Dynamic.
2. Select Show Dynamic MAC from the Action list.
3. Select the Sort Key (MAC Address, VLAN, or Interface).
4. Enter the search parameters (MAC Address, VLAN, or Interface).
5. Click Query.

Figure 97: Displaying the Dynamic MAC Address Table

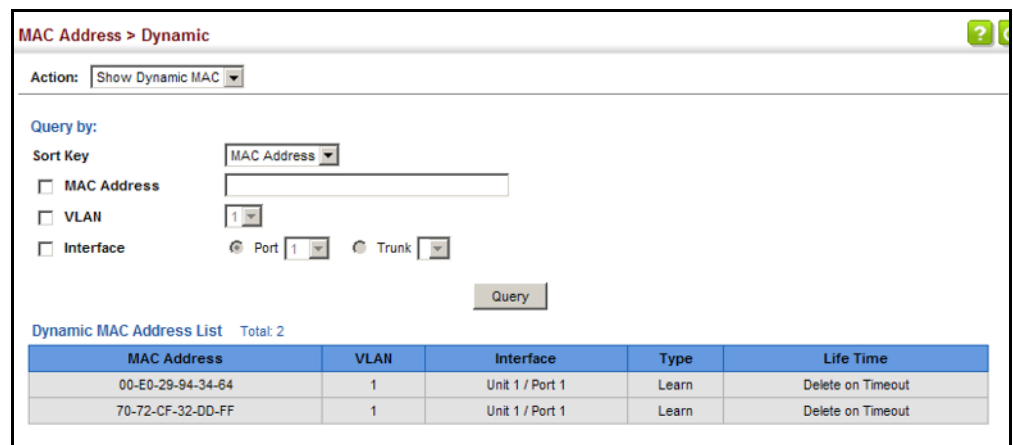

CLEARING THE DYNAMIC ADDRESS TABLE

Use the MAC Address > Dynamic (Clear Dynamic MAC) page to remove any learned entries from the forwarding database.

CLI REFERENCES

- ◆ ["clear mac-address-table dynamic" on page 1087](#)

PARAMETERS

These parameters are displayed:

- ◆ **Clear by** – All entries can be cleared; or you can clear the entries for a specific MAC address, all the entries in a VLAN, or all the entries associated with a port or trunk.

WEB INTERFACE

To clear the entries in the dynamic address table:

1. Click MAC Address, Dynamic.
2. Select Clear Dynamic MAC from the Action list.

3. Select the method by which to clear the entries (i.e., All, MAC Address, VLAN, or Interface).
4. Enter information in the additional fields required for clearing entries by MAC Address, VLAN, or Interface.
5. Click Clear.

Figure 98: Clearing Entries in the Dynamic MAC Address Table

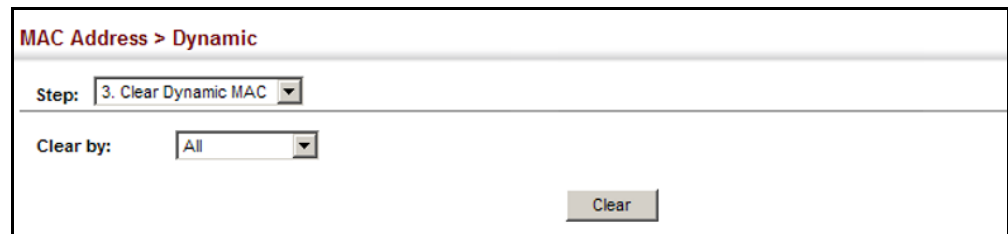

The screenshot shows a web interface for configuring MAC address settings. At the top, it says "MAC Address > Dynamic". Below that, there is a "Step:" dropdown menu currently showing "3. Clear Dynamic MAC". Underneath, there is a "Clear by:" label followed by a dropdown menu set to "All". A "Clear" button is located at the bottom right of the form area.

CONFIGURING MAC ADDRESS MIRRORING

Use the MAC Address > Mirror (Add) page to mirror traffic matching a specified source address from any port on the switch to a target port for real-time analysis. You can then attach a logic analyzer or RMON probe to the target port and study the traffic crossing the source port in a completely unobtrusive manner.

CLI REFERENCES

- ◆ ["Local Port Mirroring Commands" on page 1045](#)

COMMAND USAGE

- ◆ When mirroring traffic from a MAC address, ingress traffic with the specified source address entering any port in the switch, other than the target port, will be mirrored to the destination port.
- ◆ All mirror sessions must share the same destination port.
- ◆ Spanning Tree BPDU packets are not mirrored to the target port.
- ◆ When mirroring port traffic, the target port must be included in the same VLAN as the source port when using MSTP (see ["Spanning Tree Algorithm" on page 239](#)).
- ◆ When mirroring VLAN traffic (see ["Configuring VLAN Mirroring" on page 229](#)) or packets based on a source MAC address, the target port cannot be set to the same target ports as that used for port mirroring (see ["Configuring Local Port Mirroring" on page 160](#)).
- ◆ When traffic matches the rules for both port mirroring, and for mirroring of VLAN traffic or packets based on a MAC address, the matching packets will not be sent to target port specified for port mirroring.

PARAMETERS

These parameters are displayed:

- ◆ **Source MAC** – MAC address in the form of xx-xx-xx-xx-xx-xx or xxxxxxxxxxxx.
- ◆ **Target Port** – The port that will mirror the traffic from the source port. (Range: 1-28/52)

WEB INTERFACE

To mirror packets based on a MAC address:

1. Click MAC Address, Mirror.
2. Select Add from the Action list.
3. Specify the source MAC address and destination port.
4. Click Apply.

Figure 99: Mirroring Packets Based on the Source MAC Address

MAC Address > Mirror

Action: Add

Source MAC: 11-22-33-44-55-66

Target Port: 2

Apply Revert

To show the MAC addresses to be mirrored:

1. Click MAC Address, Mirror.
2. Select Show from the Action list.

Figure 100: Showing the Source MAC Addresses to Mirror

MAC Address > Mirror

Action: Show

MAC Mirror List Total: 1

<input type="checkbox"/>	Source (MAC)	Target (Unit/Port)
<input type="checkbox"/>	11-22-33-44-55-66	1/2

Delete Revert

This chapter describes the following basic topics:

- ◆ [Loopback Detection](#) – Configures detection and response to loopback BPDUs.
- ◆ [Global Settings for STA](#) – Configures global bridge settings for STP, RSTP and MSTP.
- ◆ [Interface Settings for STA](#) – Configures interface settings for STA, including priority, path cost, link type, and designation as an edge port.
- ◆ [Global Settings for MSTP](#) – Sets the VLANs and associated priority assigned to an MST instance
- ◆ [Interface Settings for MSTP](#) – Configures interface settings for MSTP, including priority and path cost.

OVERVIEW

The Spanning Tree Algorithm (STA) can be used to detect and disable network loops, and to provide backup links between switches, bridges or routers. This allows the switch to interact with other bridging devices (that is, an STA-compliant switch, bridge or router) in your network to ensure that only one route exists between any two stations on the network, and provide backup links which automatically take over when a primary link goes down.

The spanning tree algorithms supported by this switch include these versions:

- ◆ STP – Spanning Tree Protocol (IEEE 802.1D)
- ◆ RSTP – Rapid Spanning Tree Protocol (IEEE 802.1w)
- ◆ MSTP – Multiple Spanning Tree Protocol (IEEE 802.1s)

STP – STP uses a distributed algorithm to select a bridging device (STP-compliant switch, bridge or router) that serves as the root of the spanning tree network. It selects a root port on each bridging device (except for the root device) which incurs the lowest path cost when forwarding a packet from that device to the root device. Then it selects a designated bridging device from each LAN which incurs the lowest path cost when forwarding a packet from that LAN to the root device. All ports connected to designated bridging devices are assigned as designated ports. After determining the

lowest cost spanning tree, it enables all root ports and designated ports, and disables all other ports. Network packets are therefore only forwarded between root ports and designated ports, eliminating any possible network loops.

Figure 101: STP Root Ports and Designated Ports

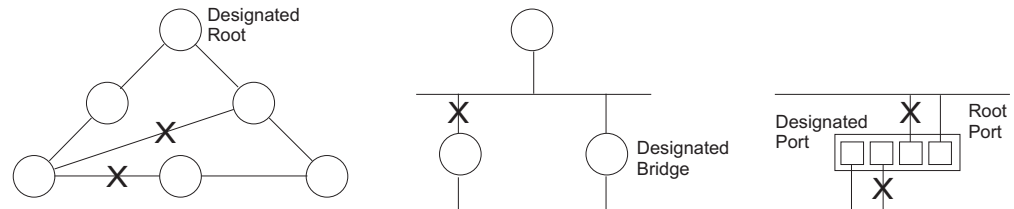

Once a stable network topology has been established, all bridges listen for Hello BPDUs (Bridge Protocol Data Units) transmitted from the Root Bridge. If a bridge does not get a Hello BPDU after a predefined interval (Maximum Age), the bridge assumes that the link to the Root Bridge is down. This bridge will then initiate negotiations with other bridges to reconfigure the network to reestablish a valid network topology.

RSTP – RSTP is designed as a general replacement for the slower, legacy STP. RSTP is also incorporated into MSTP. RSTP achieves much faster reconfiguration (i.e., around 1 to 3 seconds, compared to 30 seconds or more for STP) by reducing the number of state changes before active ports start learning, predefining an alternate route that can be used when a node or port fails, and retaining the forwarding database for ports insensitive to changes in the tree structure when reconfiguration occurs.

MSTP – When using STP or RSTP, it may be difficult to maintain a stable path between all VLAN members. Frequent changes in the tree structure can easily isolate some of the group members. MSTP (which is based on RSTP for fast convergence) is designed to support independent spanning trees based on VLAN groups. Using multiple spanning trees can provide multiple forwarding paths and enable load balancing. One or more VLANs can be grouped into a Multiple Spanning Tree Instance (MSTI). MSTP builds a separate Multiple Spanning Tree (MST) for each instance to maintain connectivity among each of the assigned VLAN groups. MSTP then builds a Internal Spanning Tree (IST) for the Region containing all commonly configured MSTP bridges.

Figure 102: MSTP Region, Internal Spanning Tree, Multiple Spanning Tree

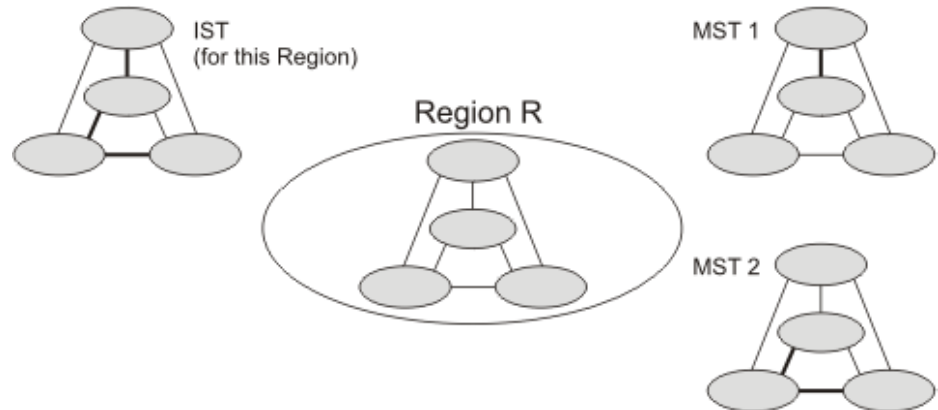

An MST Region consists of a group of interconnected bridges that have the same MST Configuration Identifiers (including the Region Name, Revision Level and Configuration Digest – see ["Configuring Multiple Spanning Trees" on page 257](#)). An MST Region may contain multiple MSTP Instances. An Internal Spanning Tree (IST) is used to connect all the MSTP switches within an MST region. A Common Spanning Tree (CST) interconnects all adjacent MST Regions, and acts as a virtual bridge node for communications with STP or RSTP nodes in the global network.

Figure 103: Spanning Tree – Common Internal, Common, Internal

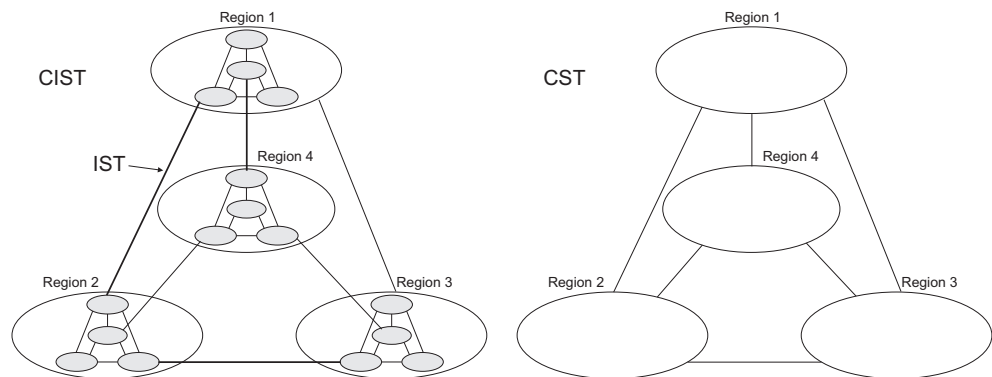

MSTP connects all bridges and LAN segments with a single Common and Internal Spanning Tree (CIST). The CIST is formed as a result of the running spanning tree algorithm between switches that support the STP, RSTP, MSTP protocols.

Once you specify the VLANs to include in a Multiple Spanning Tree Instance (MSTI), the protocol will automatically build an MSTI tree to maintain connectivity among each of the VLANs. MSTP maintains contact with the global network because each instance is treated as an RSTP node in the Common Spanning Tree (CST).

CONFIGURING LOOPBACK DETECTION

Use the Spanning Tree > Loopback Detection page to configure loopback detection on an interface. When loopback detection is enabled and a port or trunk receives its own BPDU, the detection agent drops the loopback BPDU, sends an SNMP trap, and places the interface in discarding mode. This loopback state can be released manually or automatically. If the interface is configured for automatic loopback release, then the port will only be returned to the forwarding state if one of the following conditions is satisfied:

- ◆ The interface receives any other BPDU except for its own, or;
- ◆ The interfaces' link status changes to link down and then link up again, or;
- ◆ The interface ceases to receive its own BPDUs in a forward delay interval.



NOTE: If loopback detection is not enabled and an interface receives its own BPDU, then the interface will drop the loopback BPDU according to IEEE Standard 802.1w-2001 9.3.4 (Note 1).

NOTE: Loopback detection will not be active if Spanning Tree is disabled on the switch.

NOTE: When configured for manual release mode, then a link down/up event will not release the port from the discarding state.

CLI REFERENCES

- ◆ ["Spanning Tree Commands" on page 1091](#)

PARAMETERS

These parameters are displayed:

- ◆ **Interface** – Displays a list of ports or trunks.
- ◆ **Status** – Enables loopback detection on this interface. (Default: Enabled)
- ◆ **Trap** – Enables SNMP trap notification for loopback events on this interface. (Default: Disabled)
- ◆ **Release Mode** – Configures the interface for automatic or manual loopback release. (Default: Auto)
- ◆ **Release** – Allows an interface to be manually released from discard mode. This is only available if the interface is configured for manual release mode.
- ◆ **Action** – Sets the response for loopback detection to block user traffic or shut down the interface. (Default: Block)

- ◆ **Shutdown Interval** – The duration to shut down the interface. (Range: 60-86400 seconds)

If an interface is shut down due to a detected loopback, and the release mode is set to "Auto," the selected interface will be automatically enabled when the shutdown interval has expired.

If an interface is shut down due to a detected loopback, and the release mode is set to "Manual," the interface can be re-enabled using the Release button.

WEB INTERFACE

To configure loopback detection:

1. Click Spanning Tree, Loopback Detection.
2. Click Port or Trunk to display the required interface type.
3. Modify the required loopback detection attributes.
4. Click Apply

Figure 104: Configuring Port Loopback Detection

Port	Status	Trap	Release Mode	Release	Action	Shutdown Interval (60-86400 sec)
1	<input checked="" type="checkbox"/> Enabled	<input type="checkbox"/> Enabled	Auto	Release	Block	
2	<input checked="" type="checkbox"/> Enabled	<input type="checkbox"/> Enabled	Auto	Release	Block	
3	<input checked="" type="checkbox"/> Enabled	<input type="checkbox"/> Enabled	Auto	Release	Block	
4	<input checked="" type="checkbox"/> Enabled	<input type="checkbox"/> Enabled	Auto	Release	Block	
5	<input checked="" type="checkbox"/> Enabled	<input checked="" type="checkbox"/> Enabled	Manual	Release	Shutdown	60

CONFIGURING GLOBAL SETTINGS FOR STA

Use the Spanning Tree > STA (Configure Global - Configure) page to configure global settings for the spanning tree that apply to the entire switch.

CLI REFERENCES

- ◆ ["Spanning Tree Commands" on page 1091](#)

COMMAND USAGE

- ◆ Spanning Tree Protocol³

This option uses RSTP set to STP forced compatibility mode. It uses RSTP for the internal state machine, but sends only 802.1D BPDUs.

3. STP and RSTP BPDUs are transmitted as untagged frames, and will cross any VLAN boundaries.

This creates one spanning tree instance for the entire network. If multiple VLANs are implemented on a network, the path between specific VLAN members may be inadvertently disabled to prevent network loops, thus isolating group members. When operating multiple VLANs, we recommend selecting the MSTP option.

◆ Rapid Spanning Tree Protocol³

RSTP supports connections to either STP or RSTP nodes by monitoring the incoming protocol messages and dynamically adjusting the type of protocol messages the RSTP node transmits, as described below:

- STP Mode – If the switch receives an 802.1D BPDU (i.e., STP BPDU) after a port's migration delay timer expires, the switch assumes it is connected to an 802.1D bridge and starts using only 802.1D BPDUs.
- RSTP Mode – If RSTP is using 802.1D BPDUs on a port and receives an RSTP BPDU after the migration delay expires, RSTP restarts the migration delay timer and begins using RSTP BPDUs on that port.

◆ Multiple Spanning Tree Protocol

MSTP generates a unique spanning tree for each instance. This provides multiple pathways across the network, thereby balancing the traffic load, preventing wide-scale disruption when a bridge node in a single instance fails, and allowing for faster convergence of a new topology for the failed instance.

- To allow multiple spanning trees to operate over the network, you must configure a related set of bridges with the same MSTP configuration, allowing them to participate in a specific set of spanning tree instances.
- A spanning tree instance can exist only on bridges that have compatible VLAN instance assignments.
- Be careful when switching between spanning tree modes. Changing modes stops all spanning-tree instances for the previous mode and restarts the system in the new mode, temporarily disrupting user traffic.

PARAMETERS

These parameters are displayed:

Basic Configuration of Global Settings

- ◆ **Spanning Tree Status** – Enables/disables STA on this switch. (Default: Enabled)

- ◆ **Spanning Tree Type** – Specifies the type of spanning tree used on this switch:
 - **STP**: Spanning Tree Protocol (IEEE 802.1D); i.e., when this option is selected, the switch will use RSTP set to STP forced compatibility mode).
 - **RSTP**: Rapid Spanning Tree (IEEE 802.1w); RSTP is the default.
 - **MSTP**: Multiple Spanning Tree (IEEE 802.1s)

- ◆ **Priority** – Bridge priority is used in selecting the root device, root port, and designated port. The device with the highest priority becomes the STA root device. However, if all devices have the same priority, the device with the lowest MAC address will then become the root device. (Note that lower numeric values indicate higher priority.)
 - Default: 32768
 - Range: 0-61440, in steps of 4096
 - Options: 0, 4096, 8192, 12288, 16384, 20480, 24576, 28672, 32768, 36864, 40960, 45056, 49152, 53248, 57344, 61440

- ◆ **BPDU Flooding** – Configures the system to flood BPDUs to all other ports on the switch or just to all other ports in the same VLAN when spanning tree is disabled globally on the switch or disabled on a specific port.
 - To VLAN: Floods BPDUs to all other ports within the receiving port's native VLAN (i.e., as determined by port's PVID). This is the default.
 - To All: Floods BPDUs to all other ports on the switch.

The setting has no effect if BPDU flooding is disabled on a port (see ["Configuring Interface Settings for STA"](#)).

- ◆ **Cisco Prestandard Status** – Configures spanning tree operation to be compatible with Cisco prestandard versions. (Default: Disabled)

Cisco prestandard versions prior to Cisco IOS Release 12.2(25)SEC do not fully follow the IEEE standard, causing some state machine procedures to function incorrectly. This command forces the spanning tree protocol to function in a manner compatible with Cisco prestandard versions.

Advanced Configuration Settings

The following attributes are based on RSTP, but also apply to STP since the switch uses a backwards-compatible subset of RSTP to implement STP, and also apply to MSTP which is based on RSTP according to the standard:

- ◆ **Path Cost Method** – The path cost is used to determine the best path between devices. The path cost method is used to determine the range of values that can be assigned to each interface.
 - Long: Specifies 32-bit based values that range from 1-200,000,000. (This is the default.)
 - Short: Specifies 16-bit based values that range from 1-65535.

- ◆ **Transmission Limit** – The maximum transmission rate for BPDUs is specified by setting the minimum interval between the transmission of consecutive protocol messages. (Range: 1-10; Default: 3)

When the Switch Becomes Root

- ◆ **Hello Time** – Interval (in seconds) at which the root device transmits a configuration message.
 - Default: 2
 - Minimum: 1
 - Maximum: The lower of 10 or $[(\text{Max. Message Age} / 2) - 1]$
- ◆ **Maximum Age** – The maximum time (in seconds) a device can wait without receiving a configuration message before attempting to reconverge. All device ports (except for designated ports) should receive configuration messages at regular intervals. Any port that ages out STA information (provided in the last configuration message) becomes the designated port for the attached LAN. If it is a root port, a new root port is selected from among the device ports attached to the network. (References to “ports” in this section mean “interfaces,” which includes both ports and trunks.)
 - Default: 20
 - Minimum: The higher of 6 or $[2 \times (\text{Hello Time} + 1)]$
 - Maximum: The lower of 40 or $[2 \times (\text{Forward Delay} - 1)]$
- ◆ **Forward Delay** – The maximum time (in seconds) this device will wait before changing states (i.e., discarding to learning to forwarding). This delay is required because every device must receive information about topology changes before it starts to forward frames. In addition, each port needs time to listen for conflicting information that would make it return to a discarding state; otherwise, temporary data loops might result.
 - Default: 15
 - Minimum: The higher of 4 or $[(\text{Max. Message Age} / 2) + 1]$
 - Maximum: 30

RSTP does not depend on the forward delay timer in most cases. It is able to confirm that a port can transition to the forwarding state without having to rely on any timer configuration. To achieve fast convergence, RSTP relies on the use of edge ports, and automatic detection of point-to-point link types, both of which allow a port to directly transition to the forwarding state.

Configuration Settings for MSTP

- ◆ **Max Instance Numbers** – The maximum number of MSTP instances to which this switch can be assigned.
- ◆ **Configuration Digest** – An MD5 signature key that contains the VLAN ID to MST ID mapping table. In other words, this key is a mapping of all VLANs to the CIST.

- ◆ **Region Revision**⁴ – The revision for this MSTI. (Range: 0-65535; Default: 0)
- ◆ **Region Name**⁴ – The name for this MSTI. (Maximum length: 32 characters; Default: switch’s MAC address)
- ◆ **Max Hop Count** – The maximum number of hops allowed in the MST region before a BPDU is discarded. (Range: 1-40; Default: 20)



NOTE: Region Revision and Region Name and are both required to uniquely identify an MST region.

WEB INTERFACE

To configure global STA settings:

1. Click Spanning Tree, STA.
2. Select Configure Global from the Step list.
3. Select Configure from the Action list.
4. Modify any of the required attributes. Note that the parameters displayed for the spanning tree types (STP, RSTP, MSTP) varies as described in the preceding section.
5. Click Apply

Figure 105: Configuring Global Settings for STA (STP)

The screenshot displays the configuration page for Spanning Tree > STA. At the top, there are dropdown menus for 'Step' (set to '1. Configure Global') and 'Action' (set to 'Configure'). The main configuration area includes several settings:

- Spanning Tree Status:** Enabled
- Spanning Tree Type:** STP (dropdown)
- Priority (0-61440, in steps of 4096):** 32768 (text input)
- BPDU Flooding:** To VLAN (dropdown)
- Cisco Prestandard Status:** Enabled
- Advanced:**
 - Path Cost Method:** Long (dropdown)
 - Transmission Limit (1-10):** 3 (text input)
- When the Switch Becomes Root:**
 - Hello Time (1-10):** 2 (text input) sec
 - Maximum Age (6-40):** 20 (text input) sec
 - Forward Delay (4-30):** 15 (text input) sec

A note at the bottom of the configuration area reads: *Note: 2 * (Hello Time + 1) <= Max Age <= 2 * (Forward Delay - 1)*. At the bottom right, there are 'Apply' and 'Revert' buttons.

4. The MST name and revision number are both required to uniquely identify an MST region.

Figure 106: Configuring Global Settings for STA (RSTP)

Spanning Tree > STA

Step: 1. Configure Global Action: Configure

Spanning Tree Status Enabled

Spanning Tree Type RSTP

Priority (0-61440, in steps of 4096) 32768

BPDU Flooding To VLAN

Cisco Prestandard Status Enabled

Advanced:

Path Cost Method Long

Transmission Limit (1-10) 3

When the Switch Becomes Root:

Hello Time (1-10) 2 sec

Maximum Age (6-40) 20 sec

Forward Delay (4-30) 15 sec

Note: $2 * (\text{Hello Time} + 1) \leq \text{Max Age} \leq 2 * (\text{Forward Delay} - 1)$

Apply Revert

Figure 107: Configuring Global Settings for STA (MSTP)

Spanning Tree > STA

Step: 1. Configure Global Action: Configure

Spanning Tree Status Enabled

Spanning Tree Type MSTP

Priority (0-61440, in steps of 4096) 32768

BPDU Flooding To VLAN

Cisco Prestandard Status Enabled

Advanced:

Path Cost Method Long

Transmission Limit (1-10) 3

When the Switch Becomes Root:

Hello Time (1-10) 2 sec

Maximum Age (6-40) 20 sec

Forward Delay (4-30) 15 sec

Note: $2 * (\text{Hello Time} + 1) \leq \text{Max Age} \leq 2 * (\text{Forward Delay} - 1)$

MSTP Configuration

Max Instance Numbers 16

Configuration Digest 0xAC36177F50283CD4B83821D8AB26DE62

Region Revision (0-65535) 0

Region Name 00 e0 0c 00 00 fd

Max Hop Count (1-40) 20

Apply Revert

DISPLAYING GLOBAL SETTINGS FOR STA

Use the Spanning Tree > STA (Configure Global - Show Information) page to display a summary of the current bridge STA information that applies to the entire switch.

CLI REFERENCES

- ◆ ["show spanning-tree" on page 1116](#)
- ◆ ["show spanning-tree mst configuration" on page 1118](#)

PARAMETERS

The parameters displayed are described in the preceding section, except for the following items:

- ◆ **Bridge ID** – A unique identifier for this bridge, consisting of the bridge priority, the MST Instance ID 0 for the Common Spanning Tree when spanning tree type is set to MSTP, and MAC address (where the address is taken from the switch system).
- ◆ **Designated Root** – The priority and MAC address of the device in the Spanning Tree that this switch has accepted as the root device.
- ◆ **Root Port** – The number of the port on this switch that is closest to the root. This switch communicates with the root device through this port. If there is no root port, then this switch has been accepted as the root device of the Spanning Tree network.
- ◆ **Root Path Cost** – The path cost from the root port on this switch to the root device.
- ◆ **Configuration Changes** – The number of times the Spanning Tree has been reconfigured.
- ◆ **Last Topology Change** – Time since the Spanning Tree was last reconfigured.

WEB INTERFACE

To display global STA settings:

1. Click Spanning Tree, STA.
2. Select Configure Global from the Step list.
3. Select Show Information from the Action list.

Figure 108: Displaying Global Settings for STA

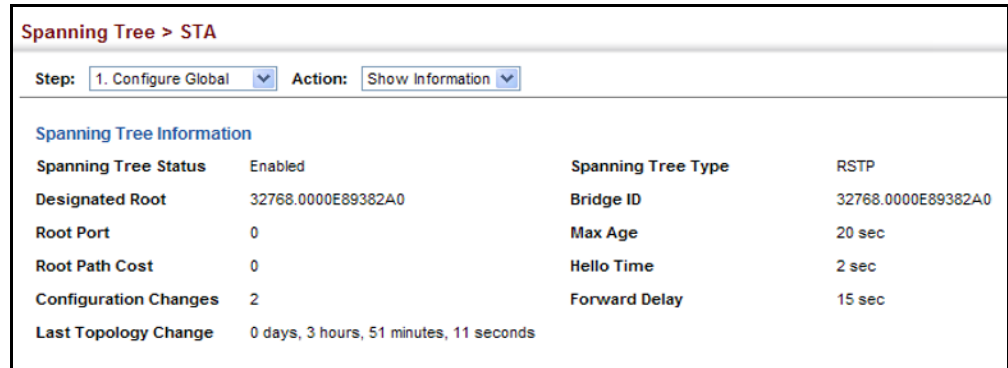

The screenshot shows the 'Spanning Tree > STA' configuration page. At the top, there are two dropdown menus: 'Step: 1. Configure Global' and 'Action: Show Information'. Below this is a section titled 'Spanning Tree Information' containing a table of settings.

Spanning Tree Information			
Spanning Tree Status	Enabled	Spanning Tree Type	RSTP
Designated Root	32768.0000E89382A0	Bridge ID	32768.0000E89382A0
Root Port	0	Max Age	20 sec
Root Path Cost	0	Hello Time	2 sec
Configuration Changes	2	Forward Delay	15 sec
Last Topology Change	0 days, 3 hours, 51 minutes, 11 seconds		

CONFIGURING INTERFACE SETTINGS FOR STA

Use the Spanning Tree > STA (Configure Interface - Configure) page to configure RSTP and MSTP attributes for specific interfaces, including port priority, path cost, link type, and edge port. You may use a different priority or path cost for ports of the same media type to indicate the preferred path, link type to indicate a point-to-point connection or shared-media connection, and edge port to indicate if the attached device can support fast forwarding. (References to "ports" in this section means "interfaces," which includes both ports and trunks.)

CLI REFERENCES

- ◆ ["Spanning Tree Commands" on page 1091](#)

PARAMETERS

These parameters are displayed:

- ◆ **Interface** – Displays a list of ports or trunks.
- ◆ **Spanning Tree** – Enables/disables STA on this interface. (Default: Enabled)
- ◆ **BPDU Flooding** – Enables/disables the flooding of BPDUs to other ports when global spanning tree is disabled ([page 243](#)) or when spanning tree is disabled on a specific port. When flooding is enabled, BPDUs are flooded to all other ports on the switch or to all other ports within the receiving port's native VLAN as specified by the Spanning Tree BPDU Flooding attribute ([page 243](#)). (Default: Enabled)

- ◆ **Priority** – Defines the priority used for this port in the Spanning Tree Protocol. If the path cost for all ports on a switch are the same, the port with the highest priority (i.e., lowest value) will be configured as an active link in the Spanning Tree. This makes a port with higher priority less likely to be blocked if the Spanning Tree Protocol is detecting network loops. Where more than one port is assigned the highest priority, the port with lowest numeric identifier will be enabled.
 - Default: 128
 - Range: 0-240, in steps of 16
- ◆ **Admin Path Cost** – This parameter is used by the STA to determine the best path between devices. Therefore, lower values should be assigned to ports attached to faster media, and higher values assigned to ports with slower media. Note that path cost takes precedence over port priority. (Range: 0 for auto-configuration, 1-65535 for the short path cost method, 1-200,000,000 for the long path cost method)⁵

By default, the system automatically detects the speed and duplex mode used on each port, and configures the path cost according to the values shown below. Path cost “0” is used to indicate auto-configuration mode. When the short path cost method is selected and the default path cost recommended by the IEEE 8021w standard exceeds 65,535, the default is set to 65,535.

Table 12: Recommended STA Path Cost Range

Port Type	IEEE 802.1D-1998	IEEE 802.1w-2001
Ethernet	50-600	200,000-20,000,000
Fast Ethernet	10-60	20,000-2,000,000
Gigabit Ethernet	3-10	2,000-200,000

Table 13: Default STA Path Costs

Port Type	Short Path Cost (IEEE 802.1D-1998)	Long Path Cost (IEEE 802.1D-2004)
Ethernet	65,535	1,000,000
Fast Ethernet	65,535	100,000
Gigabit Ethernet	10,000	10,000

- ◆ **Admin Link Type** – The link type attached to this interface.
 - Point-to-Point – A connection to exactly one other bridge.
 - Shared – A connection to two or more bridges.

5. Refer to ["Configuring Global Settings for STA" on page 243](#) for information on setting the path cost method. The range displayed on the STA interface configuration page shows the maximum value for path cost. However, note that the switch still enforces the rules for path cost based on the specified path cost method (long or short).

- Auto – The switch automatically determines if the interface is attached to a point-to-point link or to shared media. (This is the default setting.)
- ◆ **Root Guard** – STA allows a bridge with a lower bridge identifier (or same identifier and lower MAC address) to take over as the root bridge at any time. Root Guard can be used to ensure that the root bridge is not formed at a suboptimal location. Root Guard should be enabled on any designated port connected to low-speed bridges which could potentially overload a slower link by taking over as the root port and forming a new spanning tree topology. It could also be used to form a border around part of the network where the root bridge is allowed. (Default: Disabled)
- ◆ **Admin Edge Port** – Since end nodes **cannot** cause forwarding loops, they can pass directly through to the spanning tree forwarding state. Specifying Edge Ports provides quicker convergence for devices such as workstations or servers, retains the current forwarding database to reduce the amount of frame flooding required to rebuild address tables during reconfiguration events, does not cause the spanning tree to initiate reconfiguration when the interface changes state, and also overcomes other STA-related timeout problems. However, remember that Edge Port should only be enabled for ports connected to an end-node device. (Default: Auto)
 - **Enabled** – Manually configures a port as an Edge Port.
 - **Disabled** – Disables the Edge Port setting.
 - **Auto** – The port will be automatically configured as an edge port if the edge delay time expires without receiving any RSTP or MSTP BPDUs. Note that edge delay time (802.1D-2004 17.20.4) equals the protocol migration time if a port's link type is point-to-point (which is 3 seconds as defined in IEEE 802.3D-2004 17.20.4); otherwise it equals the spanning tree's maximum age for configuration messages (see maximum age under "[Configuring Global Settings for STA](#)" on page 243).

An interface cannot function as an edge port under the following conditions:

- If spanning tree mode is set to STP ([page 243](#)), edge-port mode cannot automatically transition to operational edge-port state using the automatic setting.
- If loopback detection is enabled ([page 242](#)) and a loopback BPDU is detected, the interface cannot function as an edge port until the loopback state is released.
- If an interface is in forwarding state and its role changes, the interface cannot continue to function as an edge port even if the edge delay time has expired.

- If the port does not receive any BPDUs after the edge delay timer expires, its role changes to designated port and it immediately enters forwarding state (see "[Displaying Interface Settings for STA](#)" on page 254).
- ◆ **BPDU Guard** – This feature protects edge ports from receiving BPDUs. It prevents loops by shutting down an edge port when a BPDU is received instead of putting it into the spanning tree discarding state. In a valid configuration, configured edge ports should not receive BPDUs. If an edge port receives a BPDU an invalid configuration exists, such as a connection to an unauthorized device. The BPDU guard feature provides a secure response to invalid configurations because an administrator must manually enable the port. (Default: Disabled)
- ◆ **BPDU Filter** – BPDU filtering allows you to avoid transmitting BPDUs on configured edge ports that are connected to end nodes. By default, STA sends BPDUs to all ports regardless of whether administrative edge is enabled on a port. BPDU filtering is configured on a per-port basis. (Default: Disabled)
- ◆ **Migration** – If at any time the switch detects STP BPDUs, including Configuration or Topology Change Notification BPDUs, it will automatically set the selected interface to forced STP-compatible mode. However, you can also use the Protocol Migration button to manually re-check the appropriate BPDU format (RSTP or STP-compatible) to send on the selected interfaces. (Default: Disabled)

WEB INTERFACE

To configure interface settings for STA:

1. Click Spanning Tree, STA.
2. Select Configure Interface from the Step list.
3. Select Configure from the Action list.
4. Modify any of the required attributes.
5. Click Apply.

Figure 109: Configuring Interface Settings for STA

Port	Spanning Tree	BPDU Flooding	Priority (0-240, in steps of 16)	Admin Path Cost (0-200000000, 0: Auto)	Admin Link Type	Root Guard	Admin Edge Port	BPDU Guard	BPDU Filter	Migration
1	<input checked="" type="checkbox"/> Enabled	<input checked="" type="checkbox"/> Enabled	128	0	Auto	<input checked="" type="checkbox"/> Enabled	Auto	<input checked="" type="checkbox"/> Enabled	<input checked="" type="checkbox"/> Enabled	<input checked="" type="checkbox"/> Enabled
2	<input checked="" type="checkbox"/> Enabled	<input checked="" type="checkbox"/> Enabled	128	0	Auto	<input checked="" type="checkbox"/> Enabled	Auto	<input checked="" type="checkbox"/> Enabled	<input checked="" type="checkbox"/> Enabled	<input checked="" type="checkbox"/> Enabled
3	<input checked="" type="checkbox"/> Enabled	<input checked="" type="checkbox"/> Enabled	128	0	Auto	<input checked="" type="checkbox"/> Enabled	Auto	<input checked="" type="checkbox"/> Enabled	<input checked="" type="checkbox"/> Enabled	<input checked="" type="checkbox"/> Enabled
4	<input checked="" type="checkbox"/> Enabled	<input checked="" type="checkbox"/> Enabled	128	0	Auto	<input checked="" type="checkbox"/> Enabled	Auto	<input checked="" type="checkbox"/> Enabled	<input checked="" type="checkbox"/> Enabled	<input checked="" type="checkbox"/> Enabled
5	<input checked="" type="checkbox"/> Enabled	<input checked="" type="checkbox"/> Enabled	128	0	Auto	<input checked="" type="checkbox"/> Enabled	Auto	<input checked="" type="checkbox"/> Enabled	<input checked="" type="checkbox"/> Enabled	<input checked="" type="checkbox"/> Enabled

DISPLAYING INTERFACE SETTINGS FOR STA

Use the Spanning Tree > STA (Configure Interface - Show Information) page to display the current status of ports or trunks in the Spanning Tree.

CLI REFERENCES

- ◆ ["show spanning-tree" on page 1116](#)

PARAMETERS

These parameters are displayed:

- ◆ **Spanning Tree** – Shows if STA has been enabled on this interface.
- ◆ **BPDU Flooding** – Shows if BPDUs will be flooded to other ports when spanning tree is disabled globally on the switch or disabled on a specific port.
- ◆ **STA Status** – Displays current state of this port within the Spanning Tree:
 - **Discarding** - Port receives STA configuration messages, but does not forward packets.
 - **Learning** - Port has transmitted configuration messages for an interval set by the Forward Delay parameter without receiving contradictory information. Port address table is cleared, and the port begins learning addresses.
 - **Forwarding** - Port forwards packets, and continues learning addresses.

The rules defining port status are:

- A port on a network segment with no other STA compliant bridging device is always forwarding.
 - If two ports of a switch are connected to the same segment and there is no other STA device attached to this segment, the port with the smaller ID forwards packets and the other is discarding.
 - All ports are discarding when the switch is booted, then some of them change state to learning, and then to forwarding.
- ◆ **Forward Transitions** – The number of times this port has transitioned from the Learning state to the Forwarding state.
 - ◆ **Designated Cost** – The cost for a packet to travel from this port to the root in the current Spanning Tree configuration. The slower the media, the higher the cost.
 - ◆ **Designated Bridge** – The bridge priority and MAC address of the device through which this port must communicate to reach the root of the Spanning Tree.
 - ◆ **Designated Port** – The port priority and number of the port on the designated bridging device through which this switch must communicate with the root of the Spanning Tree.
 - ◆ **Oper Path Cost** – The contribution of this port to the path cost of paths towards the spanning tree root which include this port.
 - ◆ **Oper Link Type** – The operational point-to-point status of the LAN segment attached to this interface. This parameter is determined by manual configuration or by auto-detection, as described for Admin Link Type in STA Port Configuration on [page 250](#).
 - ◆ **Oper Edge Port** – This parameter is initialized to the setting for Admin Edge Port in STA Port Configuration on [page 250](#) (i.e., true or false), but will be set to false if a BPDU is received, indicating that another bridge is attached to this port.
 - ◆ **Port Role** – Roles are assigned according to whether the port is part of the active topology, that is the best port connecting a non-root bridge to the root bridge (i.e., **root** port), connecting a LAN through the bridge to the root bridge (i.e., **designated** port), is the MSTI regional root (i.e., **master** port), or is an **alternate** or **backup** port that may provide connectivity if other bridges, bridge ports, or LANs fail or are removed. The role is set to disabled (i.e., **disabled** port) if a port has no role within the spanning tree.

Figure 110: STA Port Roles

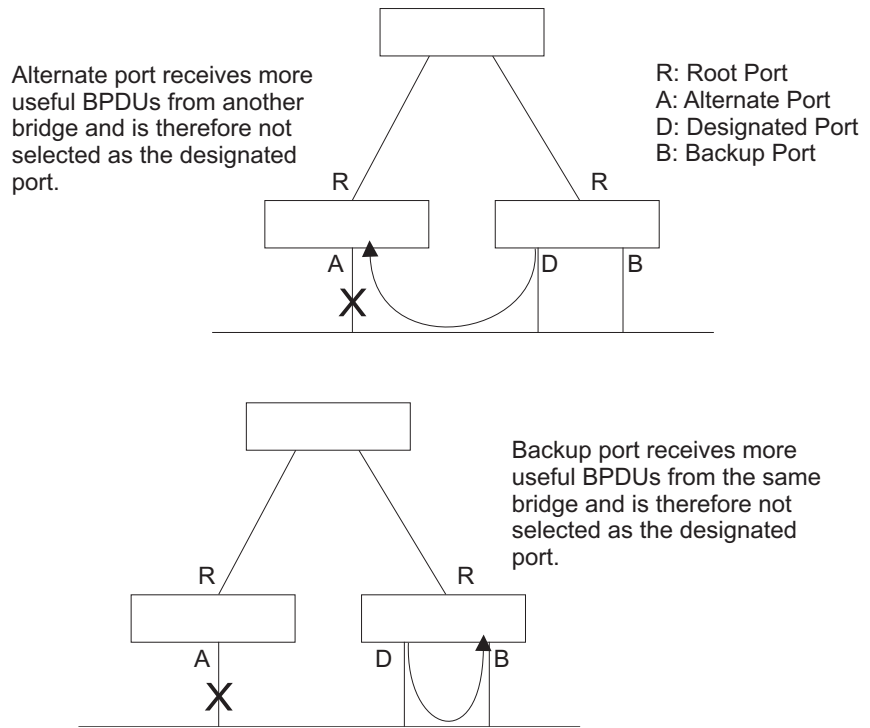

WEB INTERFACE

To display interface settings for STA:

1. Click Spanning Tree, STA.
2. Select Configure Interface from the Step list.
3. Select Show Information from the Action list.

Figure 111: Displaying Interface Settings for STA

Spanning Tree > STA

Step: 2. Configure Interface Action: Show Information

Interface Port Trunk

Spanning Tree Port List Total: 52

Port	Spanning Tree	BPDU Flooding	STA Status	Forward Transitions	Designated Cost	Designated Bridge	Designated Port	Oper Path Cost	Oper Link Type	Oper Edge Port	Port Role
1	Enabled	Enabled	Discarding	8	10000	32768.00E00C109000	128.3	100000	Point-to-Point	Disabled	Alternate
2	Enabled	Enabled	Discarding	0	10000	32768.7072CF833466	128.2	10000	Point-to-Point	Disabled	Disabled
3	Enabled	Enabled	Discarding	0	10000	32768.7072CF833466	128.3	10000	Point-to-Point	Disabled	Disabled
4	Enabled	Enabled	Discarding	0	10000	32768.7072CF833466	128.4	10000	Point-to-Point	Disabled	Disabled
5	Enabled	Enabled	Discarding	0	10000	32768.7072CF833466	128.5	10000	Point-to-Point	Disabled	Disabled

CONFIGURING MULTIPLE SPANNING TREES

Use the Spanning Tree > MSTP (Configure Global) page to create an MSTP instance, or to add VLAN groups to an MSTP instance.

CLI REFERENCES

- ◆ "Spanning Tree Commands" on page 1091

COMMAND USAGE

MSTP generates a unique spanning tree for each instance. This provides multiple pathways across the network, thereby balancing the traffic load, preventing wide-scale disruption when a bridge node in a single instance fails, and allowing for faster convergence of a new topology for the failed instance.

By default all VLANs are assigned to the Internal Spanning Tree (MST Instance 0) that connects all bridges and LANs within the MST region. This switch supports up to 16 instances. You should try to group VLANs which cover the same general area of your network. However, remember that you must configure all bridges within the same MSTI Region (page 243) with the same set of instances, and the same instance (on each bridge) with the same set of VLANs. Also, note that RSTP treats each MSTI region as a single node, connecting all regions to the Common Spanning Tree.

To use multiple spanning trees:

1. Set the spanning tree type to MSTP (page 243).
2. Enter the spanning tree priority for the selected MST instance on the Spanning Tree > MSTP (Configure Global - Add) page.
3. Add the VLANs that will share this MSTI on the Spanning Tree > MSTP (Configure Global - Add Member) page.



NOTE: All VLANs are automatically added to the IST (Instance 0).

To ensure that the MSTI maintains connectivity across the network, you must configure a related set of bridges with the same MSTI settings.

PARAMETERS

These parameters are displayed:

- ◆ **MST ID** – Instance identifier to configure. (Range: 0-4094)
- ◆ **VLAN ID** – VLAN to assign to this MST instance. (Range: 1-4094)
- ◆ **Priority** – The priority of a spanning tree instance. (Range: 0-61440 in steps of 4096; Options: 0, 4096, 8192, 12288, 16384, 20480, 24576, 28672, 32768, 36864, 40960, 45056, 49152, 53248, 57344, 61440; Default: 32768)

WEB INTERFACE

To create instances for MSTP:

1. Click Spanning Tree, MSTP.
2. Select Configure Global from the Step list.
3. Select Add from the Action list.
4. Specify the MST instance identifier and the initial VLAN member. Additional member can be added using the Spanning Tree > MSTP (Configure Global - Add Member) page. If the priority is not specified, the default value 32768 is used.
5. Click Apply.

Figure 112: Creating an MST Instance

The screenshot shows the 'Spanning Tree > MSTP' configuration page. At the top, the breadcrumb 'Spanning Tree > MSTP' is visible. Below it, there are two dropdown menus: 'Step: 1. Configure Global' and 'Action: Add'. The main form contains three input fields: 'MST ID (0-4094)' with the value '1', 'VLAN ID (1-4094)' with the value '1', and 'Priority (0-61440, in steps of 4096)' which is empty. At the bottom right, there are 'Apply' and 'Revert' buttons.

To show the MSTP instances:

1. Click Spanning Tree, MSTP.
2. Select Configure Global from the Step list.
3. Select Show from the Action list.

Figure 113: Displaying MST Instances

The screenshot shows the 'Spanning Tree > MSTP' configuration page with the 'Action' dropdown set to 'Show'. Below the dropdowns, there is a table titled 'MST List Total: 2'. The table has a header row with a checkbox and 'MST ID'. There are two data rows: one with '0' and one with '1'. At the bottom right, there are 'Delete' and 'Revert' buttons.

<input type="checkbox"/>	MST ID
<input type="checkbox"/>	0
<input type="checkbox"/>	1

To modify the priority for an MST instance:

1. Click Spanning Tree, MSTP.
2. Select Configure Global from the Step list.
3. Select Modify from the Action list.
4. Modify the priority for an MSTP Instance.
5. Click Apply.

Figure 114: Modifying the Priority for an MST Instance

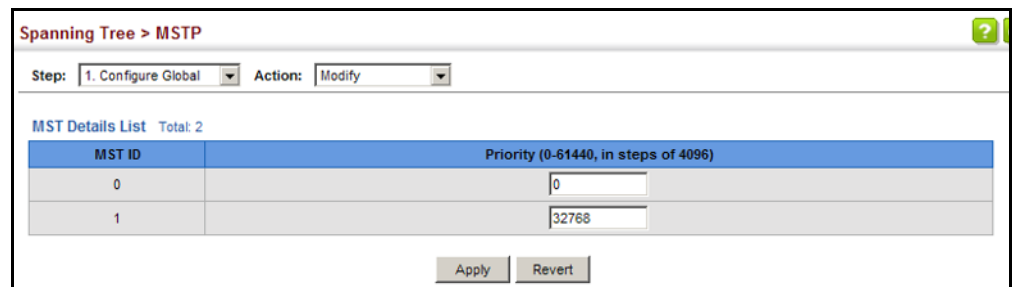

To display global settings for MSTP:

1. Click Spanning Tree, MSTP.
2. Select Configure Global from the Step list.
3. Select Show Information from the Action list.
4. Select an MST ID. The attributes displayed on this page are described under "[Displaying Global Settings for STA](#)" on page 249.

Figure 115: Displaying Global Settings for an MST Instance

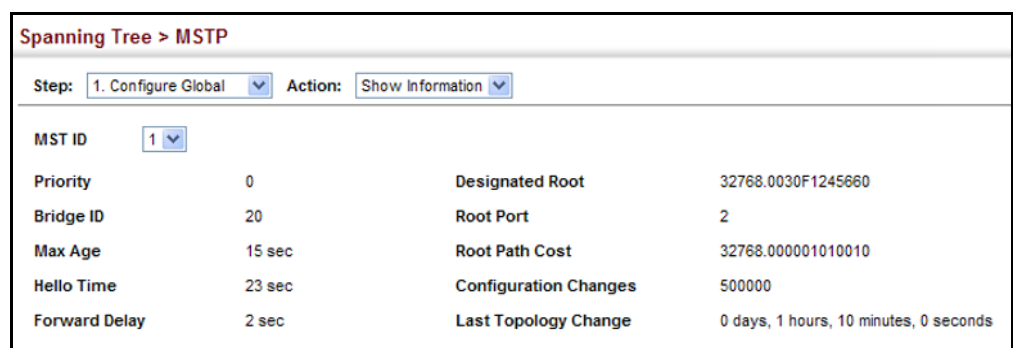

To add additional VLAN groups to an MSTP instance:

1. Click Spanning Tree, MSTP.
2. Select Configure Global from the Step list.
3. Select Add Member from the Action list.
4. Select an MST instance from the MST ID list.
5. Enter the VLAN group to add to the instance in the VLAN ID field. Note that the specified member does not have to be a configured VLAN.
6. Click Apply

Figure 116: Adding a VLAN to an MST Instance

Spanning Tree > MSTP

Step: 1. Configure Global Action: Add Member

MST ID 1

VLAN ID (1-4094) 1

Apply Revert

To show the VLAN members of an MSTP instance:

1. Click Spanning Tree, MSTP.
2. Select Configure Global from the Step list.
3. Select Show Member from the Action list.

Figure 117: Displaying Members of an MST Instance

Spanning Tree > MSTP

Step: 1. Configure Global Action: Show Member

MST ID 0

Member List Total: 4094

	VLAN
<input type="checkbox"/>	1
<input type="checkbox"/>	2
<input type="checkbox"/>	3
<input type="checkbox"/>	4
<input type="checkbox"/>	5

CONFIGURING INTERFACE SETTINGS FOR MSTP

Use the Spanning Tree > MSTP (Configure Interface - Configure) page to configure the STA interface settings for an MST instance.

CLI REFERENCES

- ◆ ["Spanning Tree Commands" on page 1091](#)

PARAMETERS

These parameters are displayed:

- ◆ **MST ID** – Instance identifier to configure. (Default: 0)
- ◆ **Interface** – Displays a list of ports or trunks.
- ◆ **STA Status** – Displays the current state of this interface within the Spanning Tree. (See ["Displaying Interface Settings for STA" on page 254](#) for additional information.)
 - **Discarding** – Port receives STA configuration messages, but does not forward packets.
 - **Learning** – Port has transmitted configuration messages for an interval set by the Forward Delay parameter without receiving contradictory information. Port address table is cleared, and the port begins learning addresses.
 - **Forwarding** – Port forwards packets, and continues learning addresses.
- ◆ **Priority** – Defines the priority used for this port in the Spanning Tree Protocol. If the path cost for all ports on a switch are the same, the port with the highest priority (i.e., lowest value) will be configured as an active link in the Spanning Tree. This makes a port with higher priority less likely to be blocked if the Spanning Tree Protocol is detecting network loops. Where more than one port is assigned the highest priority, the port with lowest numeric identifier will be enabled. (Default: 128; Range: 0-240, in steps of 16)
- ◆ **Admin MST Path Cost** – This parameter is used by the MSTP to determine the best path between devices. Therefore, lower values should be assigned to ports attached to faster media, and higher values assigned to ports with slower media. (Path cost takes precedence over port priority.) Note that when the Path Cost Method is set to short ([page 243](#)), the maximum path cost is 65,535.

By default, the system automatically detects the speed and duplex mode used on each port, and configures the path cost according to the values shown below. Path cost "0" is used to indicate auto-configuration mode. When the short path cost method is selected and the default path cost recommended by the IEEE 8021w standard exceeds 65,535, the default is set to 65,535.

The recommended range is listed in [Table 12 on page 251](#).
The default path costs are listed in [Table 13 on page 251](#).

WEB INTERFACE

To configure MSTP parameters for a port or trunk:

1. Click Spanning Tree, MSTP.
2. Select Configure Interface from the Step list.
3. Select Configure from the Action list.
4. Enter the priority and path cost for an interface
5. Click Apply.

Figure 118: Configuring MSTP Interface Settings

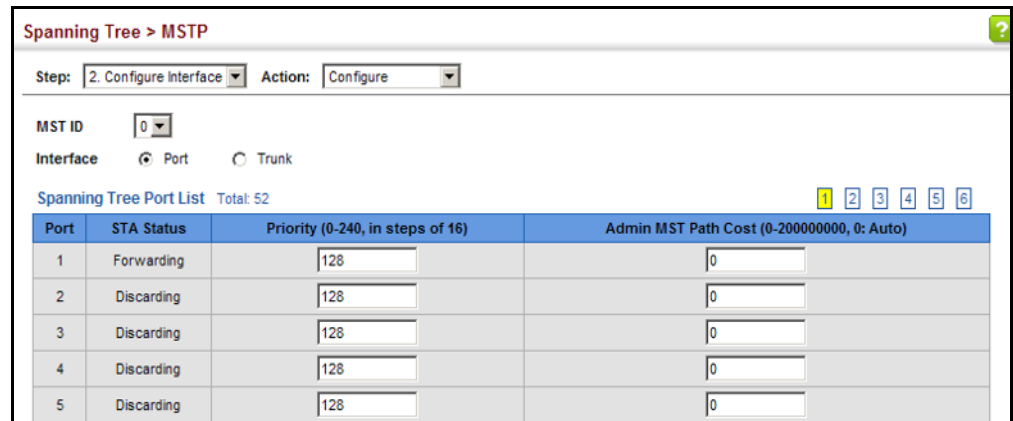

To display MSTP parameters for a port or trunk:

1. Click Spanning Tree, MSTP.
2. Select Configure Interface from the Step list.
3. Select Show Information from the Action list.

Figure 119: Displaying MSTP Interface Settings

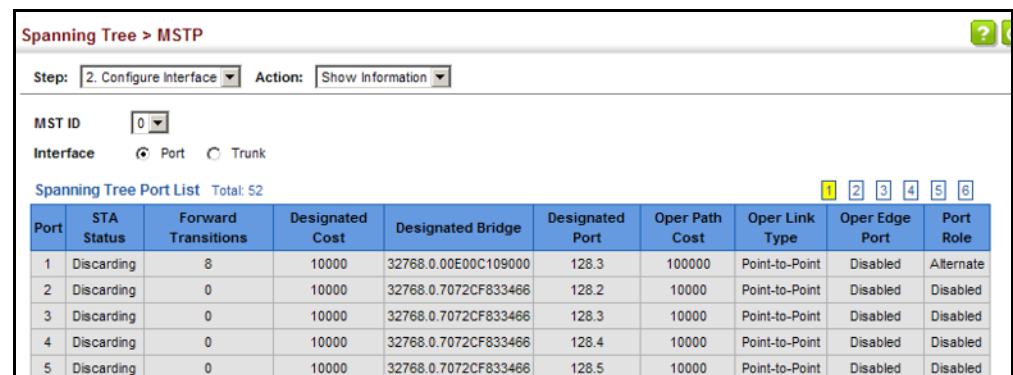

The switch can set the maximum upload or download data transfer rate for any port. It can also control traffic storms by setting a maximum threshold for broadcast traffic or multicast traffic. It can also set bounding thresholds for broadcast and multicast storms which can be used to automatically trigger rate limits or to shut down a port.

Congestion Control includes following options:

- ◆ [Rate Limiting](#) – Sets the input and output rate limits for a port.
- ◆ [Storm Control](#) – Sets the traffic storm threshold for each interface.
- ◆ [Automatic Traffic Control](#) – Sets thresholds for broadcast and multicast storms which can be used to trigger configured rate limits or to shut down a port.

RATE LIMITING

Use the Traffic > Rate Limit page to apply rate limiting to ingress or egress ports. This function allows the network manager to control the maximum rate for traffic received or transmitted on an interface. Rate limiting is configured on interfaces at the edge of a network to limit traffic into or out of the network. Packets that exceed the acceptable amount of traffic are dropped.

Rate limiting can be applied to individual ports. When an interface is configured with this feature, the traffic rate will be monitored by the hardware to verify conformity. Non-conforming traffic is dropped, conforming traffic is forwarded without any changes.

CLI REFERENCES

- ◆ ["Rate Limit Commands" on page 783](#)

PARAMETERS

These parameters are displayed:

- ◆ **Interface** – Displays the switch's ports or trunks.
- ◆ **Type** – Indicates the port type. (100BASE-FX, 1000BASE-T, 1000BASE SFP)
- ◆ **Status** – Enables or disables the rate limit. (Default: Disabled)

- ◆ **Rate** – Sets the rate limit level. (Range: 64 - 1000000 kbits per second)

WEB INTERFACE

To configure rate limits:

1. Click Traffic, Rate Limit.
2. Set the interface type to Port or Trunk.
3. Check the Status box to enable rate limiting for an interface.
4. Set the rate limit for the required interfaces.
5. Click Apply.

Figure 120: Configuring Rate Limits

Port	Type	Input		Output	
		Status	Rate (kbits/sec)	Status	Rate (kbits/sec)
1	1000BASE SFP	<input type="checkbox"/> Enabled	100000000 (64-1000000)	<input type="checkbox"/> Enabled	100000000 (64-1000000)
2	10GBASE SFP+	<input type="checkbox"/> Enabled	100000000 (64-100000000)	<input type="checkbox"/> Enabled	100000000 (64-100000000)
3	10GBASE SFP+	<input type="checkbox"/> Enabled	100000000 (64-100000000)	<input type="checkbox"/> Enabled	100000000 (64-100000000)
4	10GBASE SFP+	<input type="checkbox"/> Enabled	100000000 (64-100000000)	<input type="checkbox"/> Enabled	100000000 (64-100000000)
5	10GBASE SFP+	<input type="checkbox"/> Enabled	100000000 (64-100000000)	<input type="checkbox"/> Enabled	100000000 (64-100000000)

STORM CONTROL

Use the Traffic > Storm Control page to configure broadcast, multicast, and unknown unicast storm control thresholds. Traffic storms may occur when a device on your network is malfunctioning, or if application programs are not well designed or properly configured. If there is too much traffic on your network, performance can be severely degraded or everything can come to complete halt.

You can protect your network from traffic storms by setting a threshold for broadcast, multicast or unknown unicast traffic. Any packets exceeding the specified threshold will then be dropped.

CLI REFERENCES

- ◆ ["switchport packet-rate" on page 1057](#)

COMMAND USAGE

- ◆ Broadcast Storm Control is enabled by default.
- ◆ When traffic exceeds the threshold specified for broadcast and multicast or unknown unicast traffic, packets exceeding the threshold are dropped until the rate falls back down beneath the threshold.

- ◆ Traffic storms can be controlled at the hardware level using Storm Control or at the software level using [Automatic Traffic Control](#) which triggers various control responses. However, only one of these control types can be applied to a port. Enabling hardware-level storm control on a port will disable automatic storm control on that port.
- ◆ Rate limits set by the storm control function are also used by automatic storm control when the control response is set to rate control on the Auto Traffic Control (Configure Interface) page.
- ◆ Using both rate limiting and storm control on the same interface may lead to unexpected results. It is therefore not advisable to use both of these commands on the same interface.

PARAMETERS

These parameters are displayed:

- ◆ **Interface** – Displays a list of ports or trunks.
- ◆ **Type** – Indicates interface type. (100BASE-FX, 1000BASE-T, 1000BASE SFP)
- ◆ **Unknown Unicast** – Specifies storm control for unknown unicast traffic.
- ◆ **Multicast** – Specifies storm control for multicast traffic.
- ◆ **Broadcast** – Specifies storm control for broadcast traffic.
- ◆ **Status** – Enables or disables storm control. (Default: Enabled for broadcast storm control, disabled for multicast and unknown unicast storm control)
- ◆ **Rate** – Threshold level as a rate; i.e., kilobits per second. (Range: 500-1488100 pps)



NOTE: Only one rate is supported for all traffic types on an interface.

WEB INTERFACE

To configure broadcast storm control:

1. Click Traffic, Storm Control.
2. Set the interface type to Port or Trunk.
3. Set the Status field to enable or disable storm control.
4. Set the required threshold beyond which the switch will start dropping packets.
5. Click Apply.

Figure 121: Configuring Storm Control

Traffic > Storm Control							
Interface <input checked="" type="radio"/> Port <input type="radio"/> Trunk							
Port Storm Control List Total: 52							
Port	Type	Unknown Unicast		Multicast		Broadcast	
		Status	Rate (packets/sec) (500-14880000)	Status	Rate (packets/sec) (500-14880000)	Status	Rate (packets/sec) (500-14880000)
1	1000BASE SFP	<input type="checkbox"/> Enabled	262143	<input type="checkbox"/> Enabled	262143	<input checked="" type="checkbox"/> Enabled	500
2	10GBASE SFP+	<input type="checkbox"/> Enabled	262143	<input type="checkbox"/> Enabled	262143	<input checked="" type="checkbox"/> Enabled	500
3	10GBASE SFP+	<input type="checkbox"/> Enabled	262143	<input type="checkbox"/> Enabled	262143	<input checked="" type="checkbox"/> Enabled	500
4	10GBASE SFP+	<input type="checkbox"/> Enabled	262143	<input type="checkbox"/> Enabled	262143	<input checked="" type="checkbox"/> Enabled	500
5	10GBASE SFP+	<input type="checkbox"/> Enabled	262143	<input type="checkbox"/> Enabled	262143	<input checked="" type="checkbox"/> Enabled	500

AUTOMATIC TRAFFIC CONTROL

Use the Traffic > Auto Traffic Control pages to configure bounding thresholds for broadcast and multicast storms which can automatically trigger rate limits or shut down a port.

CLI REFERENCES

- ◆ "Automatic Traffic Control Commands" on page 785

COMMAND USAGE

ATC includes storm control for broadcast or multicast traffic. The control response for either of these traffic types is the same, as shown in the following diagrams.

Figure 122: Storm Control by Limiting the Traffic Rate

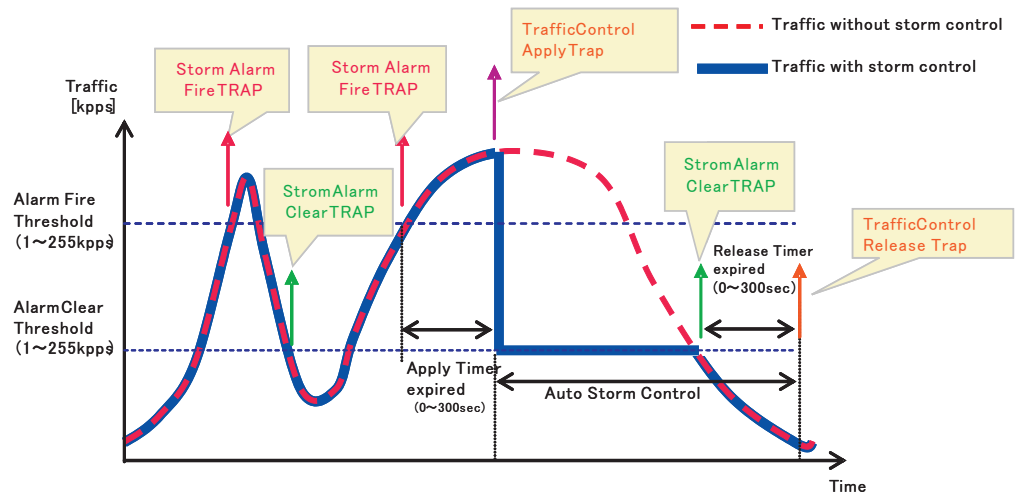

The key elements of this diagram are described below:

- ◆ Alarm Fire Threshold – The highest acceptable traffic rate. When ingress traffic exceeds the threshold, ATC sends a Storm Alarm Fire Trap and logs it.

- ◆ When traffic exceeds the alarm fire threshold and the apply timer expires, a traffic control response is applied, and a Traffic Control Apply Trap is sent and logged.
- ◆ Alarm Clear Threshold – The lower threshold beneath which a control response can be automatically terminated after the release timer expires. When ingress traffic falls below this threshold, ATC sends a Storm Alarm Clear Trap and logs it.
- ◆ When traffic falls below the alarm clear threshold after the release timer expires, traffic control (for rate limiting) will be stopped and a Traffic Control Release Trap sent and logged. Note that if the control action has shut down a port, it can only be manually re-enabled using Manual Control Release (see [page 269](#)).
- ◆ The traffic control response of rate limiting can be released automatically or manually. The control response of shutting down a port can only be released manually.

Figure 123: Storm Control by Shutting Down a Port

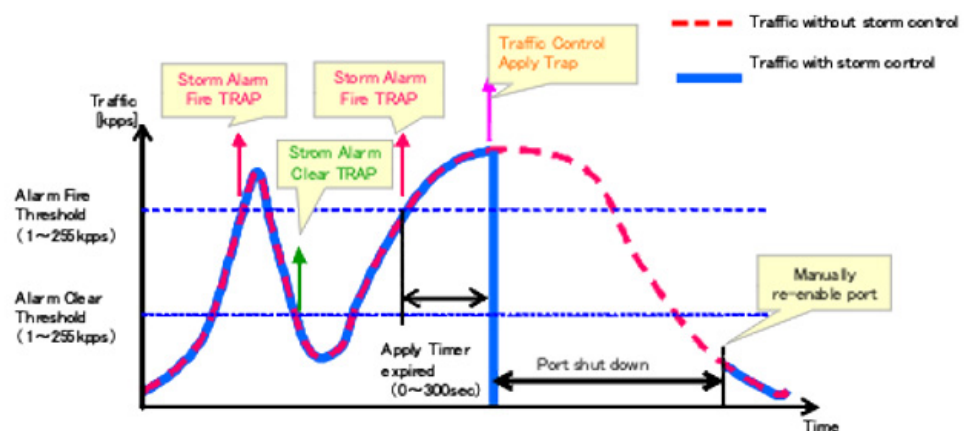

The key elements of this diagram are the same as that described in the preceding diagram, except that automatic release of the control response is not provided. When traffic control is applied, you must manually re-enable the port.

Functional Limitations

Automatic storm control is a software level control function. Traffic storms can also be controlled at the hardware level using Port Broadcast Control or Port Multicast Control (as described on [page 264](#)). However, only one of these control types can be applied to a port. Enabling automatic storm control on a port will disable hardware-level storm control on that port.

SETTING THE ATC TIMERS Use the Traffic > Auto Traffic Control (Configure Global) page to set the time at which to apply the control response after ingress traffic has exceeded the upper threshold, and the time at which to release the control response after ingress traffic has fallen beneath the lower threshold.

CLI REFERENCES

- ◆ "auto-traffic-control apply-timer" on page 788
- ◆ "auto-traffic-control release-timer" on page 788

COMMAND USAGE

- ◆ After the apply timer expires, the settings in the Traffic > Automatic Traffic Control (Configure Interface) page are used to determine if a control action will be triggered (as configured under the Action field) or a trap message sent (as configured under the Trap Storm Fire field).
- ◆ The release timer only applies to a Rate Control response set in the Action field of the ATC (Interface Configuration) page. When a port has been shut down by a control response, it must be manually re-enabled using the Manual Control Release (see page 269).

PARAMETERS

These parameters are displayed:

- ◆ **Broadcast Apply Timer** – The interval after the upper threshold has been exceeded at which to apply the control response to broadcast storms. (Range: 1-300 seconds; Default: 300 seconds)
- ◆ **Broadcast Release Timer** – The time at which to release the control response after ingress traffic has fallen beneath the lower threshold for broadcast storms. (Range: 1-900 seconds; Default: 900 seconds)
- ◆ **Multicast Apply Timer** – The interval after the upper threshold has been exceeded at which to apply the control response to multicast storms. (Range: 1-300 seconds; Default: 300 seconds)
- ◆ **Multicast Release Timer** – The time at which to release the control response after ingress traffic has fallen beneath the lower threshold for multicast storms. (Range: 1-900 seconds; Default: 900 seconds)

WEB INTERFACE

To configure the response timers for automatic storm control:

1. Click Traffic, Auto Traffic Control.
2. Select Configure Global from the Step field.
3. Set the apply and release timers for broadcast and multicast storms.
4. Click Apply.

Figure 124: Configuring ATC Timers

The screenshot shows the configuration page for Auto Traffic Control. The breadcrumb is 'Traffic > Auto Traffic Control'. A dropdown menu shows 'Step: 1. Configure Global'. There are four rows of configuration items, each with a text input field and a 'sec' label:

Parameter	Value	Unit
Broadcast Apply Timer (1-300)	300	sec
Broadcast Release Timer (1-900)	900	sec
Multicast Apply Timer (1-300)	300	sec
Multicast Release Timer (1-900)	900	sec

At the bottom right, there are two buttons: 'Apply' and 'Revert'.

CONFIGURING ATC THRESHOLDS AND RESPONSES

Use the Traffic > Auto Traffic Control (Configure Interface) page to set the storm control mode (broadcast or multicast), the traffic thresholds, the control response, to automatically release a response of rate limiting, or to send related SNMP trap messages.

CLI REFERENCES

- ◆ ["Automatic Traffic Control Commands" on page 785](#)

PARAMETERS

These parameters are displayed:

- ◆ **Storm Control** – Specifies automatic storm control for broadcast traffic or multicast traffic.
- ◆ **Port** – Port identifier.
- ◆ **State** – Enables automatic traffic control for broadcast or multicast storms. (Default: Disabled)

Automatic storm control is a software level control function. Traffic storms can also be controlled at the hardware level using the [Storm Control](#) menu. However, only one of these control types can be applied to a port. Enabling automatic storm control on a port will disable hardware-level storm control on that port.
- ◆ **Action** – When the Alarm Fire Threshold (upper threshold) is exceeded and the apply timer expires, one of the following control responses will be triggered.
 - **Rate Control** – The rate of ingress traffic is limited to the level set by the Alarm Clear Threshold. Rate limiting is discontinued only after the traffic rate has fallen beneath the Alarm Clear Threshold (lower threshold), and the release timer has expired. (This is the default response.)
 - **Shutdown** – The port is administratively disabled. A port disabled by automatic traffic control can only be manually re-enabled using the Manual Control Release attribute.

- ◆ **Auto Release Control** – Automatically stops a traffic control response of rate limiting when traffic falls below the alarm clear threshold and the release timer expires as illustrated in [Figure 122 on page 266](#). When traffic control stops, the event is logged by the system and a Traffic Release Trap can be sent. (Default: Disabled)

If automatic control release is not enabled and a control response of rate limiting has been triggered, you can manually stop the rate limiting response using the Manual Control Release attribute. If the control response has shut down a port, it can also be re-enabled using Manual Control Release.

- ◆ **Alarm Fire Threshold** – The upper threshold for ingress traffic beyond which a storm control response is triggered after the Apply Timer expires. (Range: 1-255 kilo-packets per second; Default: 250 kpps)

Once the traffic rate exceeds the upper threshold and the Apply Timer expires, a trap message will be sent if configured by the Trap Storm Fire attribute.

- ◆ **Alarm Clear Threshold** – The lower threshold for ingress traffic beneath which a control response for rate limiting will be released after the Release Timer expires, if so configured by the Auto Release Control attribute. (Range: 1-255 kilo-packets per second; Default: 250 kpps)

If rate limiting has been configured as a control response and Auto Control Release is enabled, rate limiting will be discontinued after the traffic rate has fallen beneath the lower threshold, and the Release Timer has expired. Note that if a port has been shut down by a control response, it will not be re-enabled by automatic traffic control. It can only be manually re-enabled using Manual Control Release.

Once the traffic rate falls beneath the lower threshold and the Release Timer expires, a trap message will be sent if configured by the Trap Storm Clear attribute.

- ◆ **Trap Storm Fire** – Sends a trap when traffic exceeds the upper threshold for automatic storm control. (Default: Disabled)
- ◆ **Trap Storm Clear** – Sends a trap when traffic falls beneath the lower threshold after a storm control response has been triggered. (Default: Disabled)
- ◆ **Trap Traffic Apply** – Sends a trap when traffic exceeds the upper threshold for automatic storm control and the apply timer expires. (Default: Disabled)
- ◆ **Trap Traffic Release** – Sends a trap when traffic falls beneath the lower threshold after a storm control response has been triggered and the release timer expires. (Default: Disabled)
- ◆ **Manual Control Release** – Manually releases a control response of rate-limiting or port shutdown any time after the specified action has been triggered.

WEB INTERFACE

To configure the response timers for automatic storm control:

1. Click Traffic, Auto Traffic Control.
2. Select Configure Interface from the Step field.
3. Enable or disable ATC as required, set the control response, specify whether or not to automatically release the control response of rate limiting, set the upper and lower thresholds, and specify which trap messages to send.
4. Click Apply.

Figure 125: Configuring ATC Interface Attributes

Traffic > Auto Traffic Control

Step: 2. Configure Interface

Storm Control Broadcast Multicast

Auto Traffic Control Broadcast List Total: 52

Port	State	Action	Auto Release Control	Alarm Fire Threshold (kpps) (1-255)	Alarm Clear Threshold (kpps) (1-255)	Trap Storm Fire	Trap Storm Clear	Trap Traffic Apply	Trap Traffic Release	Manual Control Release
1	<input type="checkbox"/> Enabled	Rate Control	<input type="checkbox"/> Enabled	250	250	<input type="checkbox"/> Enabled	<input type="checkbox"/> Enabled	<input type="checkbox"/> Enabled	<input type="checkbox"/> Enabled	Release
2	<input type="checkbox"/> Enabled	Rate Control	<input type="checkbox"/> Enabled	250	250	<input type="checkbox"/> Enabled	<input type="checkbox"/> Enabled	<input type="checkbox"/> Enabled	<input type="checkbox"/> Enabled	Release
3	<input type="checkbox"/> Enabled	Rate Control	<input type="checkbox"/> Enabled	250	250	<input type="checkbox"/> Enabled	<input type="checkbox"/> Enabled	<input type="checkbox"/> Enabled	<input type="checkbox"/> Enabled	Release
4	<input type="checkbox"/> Enabled	Rate Control	<input type="checkbox"/> Enabled	250	250	<input type="checkbox"/> Enabled	<input type="checkbox"/> Enabled	<input type="checkbox"/> Enabled	<input type="checkbox"/> Enabled	Release
5	<input type="checkbox"/> Enabled	Rate Control	<input type="checkbox"/> Enabled	250	250	<input type="checkbox"/> Enabled	<input type="checkbox"/> Enabled	<input type="checkbox"/> Enabled	<input type="checkbox"/> Enabled	Release

Class of Service (CoS) allows you to specify which data packets have greater precedence when traffic is buffered in the switch due to congestion. This switch supports CoS with four priority queues for each port. Data packets in a port's high-priority queue will be transmitted before those in the lower-priority queues. You can set the default priority for each interface, and configure the mapping of frame priority tags to the switch's priority queues.

This chapter describes the following basic topics:

- ◆ [Layer 2 Queue Settings](#) – Configures each queue, including the default priority, queue mode, queue weight, and mapping of packets to queues based on CoS tags.
- ◆ [Layer 3/4 Priority Settings](#) – Selects the method by which inbound packets are processed (DSCP or CoS), and sets the per-hop behavior and drop precedence for internal processing.

LAYER 2 QUEUE SETTINGS

This section describes how to configure the default priority for untagged frames, set the queue mode, set the weights assigned to each queue, and map class of service tags to queues.

SETTING THE DEFAULT PRIORITY FOR INTERFACES

Use the Traffic > Priority > Default Priority page to specify the default port priority for each interface on the switch. All untagged packets entering the switch are tagged with the specified default port priority, and then sorted into the appropriate priority queue at the output port.

CLI REFERENCES

- ◆ ["switchport priority default" on page 1198](#)

COMMAND USAGE

- ◆ This switch provides four priority queues for each port. It uses Weighted Round Robin to prevent head-of-queue blockage, but can be configured to process each queue in strict order, or use a combination of strict and weighted queueing.
- ◆ The default priority applies for an untagged frame received on a port set to accept all frame types (i.e, receives both untagged and tagged frames). This priority does not apply to IEEE 802.1Q VLAN tagged

frames. If the incoming frame is an IEEE 802.1Q VLAN tagged frame, the IEEE 802.1p User Priority bits will be used.

- ◆ If the output port is an untagged member of the associated VLAN, these frames are stripped of all VLAN tags prior to transmission.

PARAMETERS

These parameters are displayed:

- ◆ **Interface** – Displays a list of ports or trunks.
- ◆ **CoS** – The priority that is assigned to untagged frames received on the specified interface. (Range: 0-7; Default: 0)

WEB INTERFACE

To configure the queue mode:

1. Click Traffic, Priority, Default Priority.
2. Select the interface type to display (Port or Trunk).
3. Modify the default priority for any interface.
4. Click Apply.

Figure 126: Setting the Default Port Priority

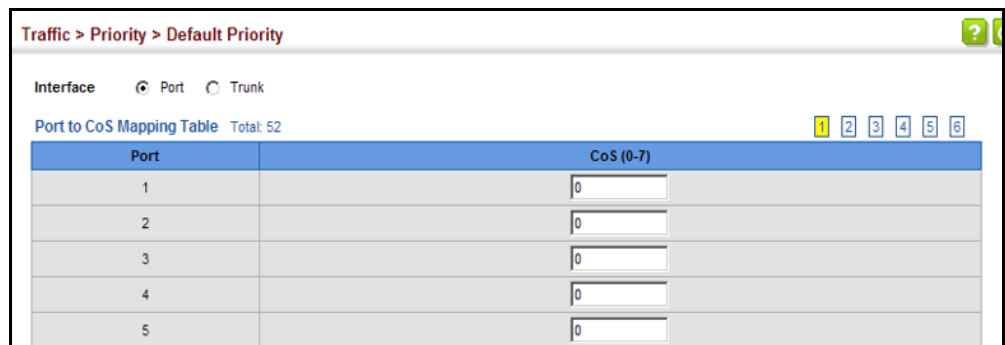

The screenshot shows a web interface for configuring network settings. The breadcrumb trail is "Traffic > Priority > Default Priority". There are radio buttons for "Interface" with "Port" selected and "Trunk" unselected. Below this is a "Port to CoS Mapping Table" with a "Total: 52" and a pagination control showing "1" selected. The table has two columns: "Port" and "CoS (0-7)".

Port	CoS (0-7)
1	0
2	0
3	0
4	0
5	0

SELECTING THE QUEUE MODE

Use the Traffic > Priority > Queue page to set the queue mode for the egress queues on any interface. The switch can be set to service the queues based on a strict rule that requires all traffic in a higher priority queue to be processed before the lower priority queues are serviced, or Weighted Round-Robin (WRR) queuing which specifies a scheduling weight for each queue. It can also be configured to use a combination of strict and weighted queuing.

CLI REFERENCES

- ◆ "queue mode" on page 1196
- ◆ "show queue mode" on page 1199

COMMAND USAGE

- ◆ Strict priority requires all traffic in a higher priority queue to be processed before lower priority queues are serviced.
- ◆ WRR queuing specifies a relative weight for each queue. WRR uses a predefined relative weight for each queue that determines the percentage of service time the switch services each queue before moving on to the next queue. This prevents the head-of-line blocking that can occur with strict priority queuing.
- ◆ If Strict and WRR mode is selected, a combination of strict service is used for the high priority queues and weighted service for the remaining queues. The queues assigned to use strict priority should be specified using the Strict Mode field parameter.
- ◆ A weight can be assigned to each of the weighted queues (and thereby to the corresponding traffic priorities). This weight sets the frequency at which each queue is polled for service, and subsequently affects the response time for software applications assigned a specific priority value.

Service time is shared at the egress ports by defining scheduling weights for WRR, or the queuing mode that uses a combination of strict and weighted queuing.

- ◆ The specified queue mode applies to all interfaces.

PARAMETERS

These parameters are displayed:

◆ Queue Mode

- **Strict** – Services the egress queues in sequential order, transmitting all traffic in the higher priority queues before servicing lower priority queues. This ensures that the highest priority packets are always serviced first, ahead of all other traffic.
- **WRR** – Weighted Round-Robin shares bandwidth at the egress ports by using scheduling weights, and servicing each queue in a round-robin fashion. (This is the default setting.)
- **Strict and WRR** – Uses strict priority on the high-priority queues and WRR on the remaining queues.

- ◆ **Queue ID** – The ID of the priority queue. (Range: 0-3)

- ◆ **Strict Mode** – If “Strict and WRR” mode is selected, then a combination of strict service is used for the high priority queues and weighted service for the remaining queues. Use this parameter to specify the queues assigned to use strict priority when using the strict-weighted queuing mode. (Default: Disabled)

- ◆ **Weight** – Sets a weight for each queue which is used by the WRR scheduler. (Range: 1-255; Default: Weights 1, 2, 4 and 6 are assigned to queues 0 - 3 respectively)

WEB INTERFACE

To configure the queue mode:

1. Click Traffic, Priority, Queue.
2. Set the queue mode.
3. If the weighted queue mode is selected, the queue weight can be modified if required.
4. If the queue mode that uses a combination of strict and weighted queuing is selected, the queues which are serviced first must be specified by enabling strict mode parameter in the table.
5. Click Apply.

Figure 127: Setting the Queue Mode (Strict)

Traffic > Priority > Queue

Queue Mode:

Apply Revert

Figure 128: Setting the Queue Mode (WRR)

Traffic > Priority > Queue

Queue Mode:

Queue Setting Table Total: 4

Queue ID	Weight (1-255)
0	<input type="text" value="1"/>
1	<input type="text" value="2"/>
2	<input type="text" value="4"/>
3	<input type="text" value="6"/>

Apply Revert

Figure 129: Setting the Queue Mode (Strict and WRR)

Traffic > Priority > Queue

Queue Mode:

Queue Setting Table Total: 4

Queue ID	Strict Mode	Weight (1-255)
0	<input type="text" value="Disabled"/>	<input type="text" value="1"/>
1	<input type="text" value="Disabled"/>	<input type="text" value="2"/>
2	<input type="text" value="Disabled"/>	<input type="text" value="4"/>
3	<input type="text" value="Disabled"/>	<input type="text" value="6"/>

Apply Revert

MAPPING CoS VALUES TO EGRESS QUEUES

Use the Traffic > Priority > PHB to Queue page to specify the hardware output queues to use based on the internal per-hop behavior value. (For more information on exact manner in which the ingress priority tags are mapped to egress queues for internal processing, see ["Mapping CoS Priorities to Internal DSCP Values" on page 283](#)).

The switch processes Class of Service (CoS) priority tagged traffic by using four priority queues for each port, with service schedules based on strict priority, Weighted Round-Robin (WRR), or a combination of strict and weighted queuing. Up to eight separate traffic priorities are defined in IEEE 802.1p. Default priority levels are assigned according to recommendations in the IEEE 802.1p standard as shown in [Table 14](#). This table indicates the default mapping of internal per-hop behavior to the hardware queues. The actual mapping may differ if the CoS priorities to internal DSCP values have been modified ([page 283](#)).

Table 14: IEEE 802.1p Egress Queue Priority Mapping

Priority	0	1	2	3	4	5	6	7
Queue	1	0	0	1	2	2	3	3

The priority levels recommended in the IEEE 802.1p standard for various network applications are shown in [Table 15](#). However, priority levels can be mapped to the switch's output queues in any way that benefits application traffic for the network.

Table 15: CoS Priority Levels

Priority Level	Traffic Type
1	Background
2	(Spare)
0 (default)	Best Effort
3	Excellent Effort
4	Controlled Load
5	Video, less than 100 milliseconds latency and jitter
6	Voice, less than 10 milliseconds latency and jitter
7	Network Control

CLI REFERENCES

- ◆ ["qos map phb-queue" on page 1203](#)

COMMAND USAGE

- ◆ Egress packets are placed into the hardware queues according to the mapping defined by this command.

- ◆ The default internal PHB to output queue mapping is shown below.

Table 16: Mapping Internal Per-hop Behavior to Hardware Queues

Per-hop Behavior	0	1	2	3	4	5	6	7
Hardware Queues	1	0	0	1	2	2	3	3

- ◆ The specified mapping applies to all interfaces.

PARAMETERS

These parameters are displayed:

- ◆ **PHB** – Per-hop behavior, or the priority used for this router hop. (Range: 0-7, where 7 is the highest priority)
- ◆ **Queue** – Output queue buffer. (Range: 0-3, where 3 is the highest CoS priority queue)

WEB INTERFACE

To map internal PHB to hardware queues:

1. Click Traffic, Priority, PHB to Queue.
2. Select Configure from the Action list.
3. Map an internal PHB to a hardware queue. Depending on how an ingress packet is processed internally based on its CoS value, and the assigned output queue, the mapping done on this page can effectively determine the service priority for different traffic classes.
4. Click Apply.

Figure 130: Mapping CoS Values to Egress Queues

Traffic > Priority > PHB to Queue

Action:

PHB (0-7)

Queue (0-3)

To show the internal PHB to hardware queue map:

1. Click Traffic, Priority, PHB to Queue.
2. Select Show from the Action list.

Figure 131: Showing CoS Values to Egress Queue Mapping

Traffic > Priority > PHB to Queue

Action: Show

PHB to Queue Mapping List Total: 8

<input type="checkbox"/>	PHB	Queue
<input type="checkbox"/>	0	1
<input type="checkbox"/>	1	0
<input type="checkbox"/>	2	0
<input type="checkbox"/>	3	1
<input type="checkbox"/>	4	2
<input type="checkbox"/>	5	2
<input type="checkbox"/>	6	3
<input type="checkbox"/>	7	3

Default Revert

LAYER 3/4 PRIORITY SETTINGS

Mapping Layer 3/4 Priorities to CoS Values

The switch supports several common methods of prioritizing layer 3/4 traffic to meet application requirements. Traffic priorities can be specified in the IP header of a frame, using the priority bits in the Type of Service (ToS) octet, or the number of the TCP/UDP port. If priority bits are used, the ToS octet may contain three bits for IP Precedence or six bits for Differentiated Services Code Point (DSCP) service. When these services are enabled, the priorities are mapped to a Class of Service value by the switch, and the traffic then sent to the corresponding output queue.

Because different priority information may be contained in the traffic, this switch maps priority values to the output queues in the following manner – The precedence for priority mapping is DSCP Priority and then Default Port Priority.



NOTE: The default settings used for mapping priority values from ingress traffic to internal DSCP values are used to determine the hardware queues used for egress traffic, not to replace the priority values. These defaults are designed to optimize priority services for the majority of network applications. It should not be necessary to modify any of the default settings, unless a queuing problem occurs with a particular application.

SETTING PRIORITY PROCESSING TO DSCP OR CoS The switch allows a choice between using DSCP or CoS priority processing methods. Use the Priority > Trust Mode page to select the required processing method.

CLI REFERENCES

- ◆ ["qos map trust-mode" on page 1204](#)

COMMAND USAGE

- ◆ If the QoS mapping mode is set to DSCP, and the ingress packet type is IPv4, then priority processing will be based on the DSCP value in the ingress packet.
- ◆ If the QoS mapping mode is set to DSCP, and a non-IP packet is received, the packet's CoS and CFI (Canonical Format Indicator) values are used for priority processing if the packet is tagged. For an untagged packet, the default port priority (see [page 273](#)) is used for priority processing.
- ◆ If the QoS mapping mode is set to CoS, and the ingress packet type is IPv4, then priority processing will be based on the CoS and CFI values in the ingress packet.

For an untagged packet, the default port priority (see [page 273](#)) is used for priority processing.

PARAMETERS

These parameters are displayed:

- ◆ **Interface** – Specifies a port or trunk.
- ◆ **Trust Mode**
 - **CoS** – Maps layer 3/4 priorities using Class of Service values. (This is the default setting.)
 - **DSCP** – Maps layer 3/4 priorities using Differentiated Services Code Point values.

WEB INTERFACE

To configure the trust mode:

1. Click Traffic, Priority, Trust Mode.
2. Select the interface type to display (Port or Trunk).
3. Set the trust mode.
4. Click Apply.

Figure 132: Setting the Trust Mode

Port	Trust Mode
1	DSCP
2	CoS
3	CoS
4	CoS
5	CoS

MAPPING INGRESS DSCP VALUES TO INTERNAL DSCP VALUES

Use the Traffic > Priority > DSCP to DSCP page to map DSCP values in incoming packets to per-hop behavior and drop precedence values for internal priority processing.

The DSCP is six bits wide, allowing coding for up to 64 different forwarding behaviors. The DSCP replaces the ToS bits, but it retains backward compatibility with the three precedence bits so that non-DSCP compliant, ToS-enabled devices, will not conflict with the DSCP mapping. Based on network policies, different kinds of traffic can be marked for different kinds of forwarding.

CLI REFERENCES

- ◆ "qos map dscp-mutation" on page 1202

COMMAND USAGE

- ◆ Enter per-hop behavior and drop precedence for any of the DSCP values 0 - 63.
- ◆ This map is only used when the priority mapping mode is set to DSCP (see page 280), and the ingress packet type is IPv4. Any attempt to configure the DSCP mutation map will not be accepted by the switch, unless the trust mode has been set to DSCP.
- ◆ Two QoS domains can have different DSCP definitions, so the DSCP-to-PHB/Drop Precedence mutation map can be used to modify one set of DSCP values to match the definition of another domain. The mutation map should be applied at the receiving port (ingress mutation) at the boundary of a QoS administrative domain.

PARAMETERS

These parameters are displayed:

- ◆ **DSCP** – DSCP value in ingress packets. (Range: 0-63)
- ◆ **PHB** – Per-hop behavior, or the priority used for this router hop. (Range: 0-7)

- ◆ **Drop Precedence** – Drop precedence used for Random Early Detection in controlling traffic congestion. (Range: 0 - Green, 3 - Yellow, 1 - Red)

Table 17: Default Mapping of DSCP Values to Internal PHB/Drop Values

	ingress-dscp1	0	1	2	3	4	5	6	7	8	9
ingress-dscp10											
0		0,0	0,1	0,0	0,3	0,0	0,1	0,0	0,3	1,0	1,1
1		1,0	1,3	1,0	1,1	1,0	1,3	2,0	2,1	2,0	2,3
2		2,0	2,1	2,0	2,3	3,0	3,1	3,0	3,3	3,0	3,1
3		3,0	3,3	4,0	4,1	4,0	4,3	4,0	4,1	4,0	4,3
4		5,0	5,1	5,0	5,3	5,0	5,1	6,0	5,3	6,0	6,1
5		6,0	6,3	6,0	6,1	6,0	6,3	7,0	7,1	7,0	7,3
6		7,0	7,1	7,0	7,3						

The ingress DSCP is composed of ingress-dscp10 (most significant digit in the left column) and ingress-dscp1 (least significant digit in the top row (in other words, $\text{ingress-dscp} = \text{ingress-dscp10} * 10 + \text{ingress-dscp1}$); and the corresponding internal-dscp is shown at the intersecting cell in the table.

The ingress DSCP is bitwise ANDed with the binary value 11 to determine the drop precedence. If the resulting value is 10 binary, then the drop precedence is set to 0.

WEB INTERFACE

To map DSCP values to internal PHB/drop precedence:

1. Click Traffic, Priority, DSCP to DSCP.
2. Select Configure from the Action list.
3. Set the PHB and drop precedence for any DSCP value.
4. Click Apply.

Figure 133: Configuring DSCP to DSCP Internal Mapping

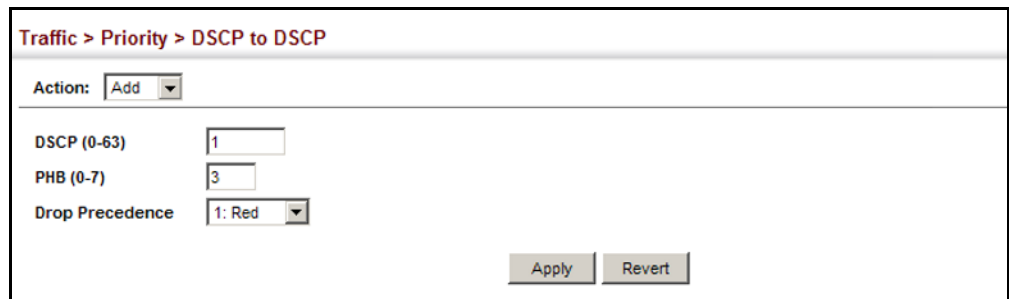

To show the DSCP to internal PHB/drop precedence map:

1. Click Traffic, Priority, DSCP to DSCP.
2. Select Show from the Action list.

Figure 134: Showing DSCP to DSCP Internal Mapping

<input type="checkbox"/>	DSCP	PHB	Drop Precedence
<input type="checkbox"/>	0	0	0
<input type="checkbox"/>	1	3	1
<input type="checkbox"/>	2	0	0
<input type="checkbox"/>	3	0	3
<input type="checkbox"/>	4	0	0
<input type="checkbox"/>	5	0	1
<input type="checkbox"/>	6	0	0
<input type="checkbox"/>	7	0	3
<input type="checkbox"/>	8	1	0
<input type="checkbox"/>	9	1	1

MAPPING CoS PRIORITIES TO INTERNAL DSCP VALUES

Use the Traffic > Priority > CoS to DSCP page to maps CoS/CFI values in incoming packets to per-hop behavior and drop precedence values for priority processing.

CLI REFERENCES

- ◆ "qos map cos-dscp" on page 1200

COMMAND USAGE

- ◆ The default mapping of CoS to PHB values is shown in Table 18 on page 284.
- ◆ Enter up to eight CoS/CFI paired values, per-hop behavior and drop precedence.
- ◆ If a packet arrives with a 802.1Q header but it is not an IP packet, then the CoS/CFI-to-PHB/Drop Precedence mapping table is used to generate priority and drop precedence values for internal processing. Note that priority tags in the original packet are not modified by this command.
- ◆ The internal DSCP consists of three bits for per-hop behavior (PHB) which determines the queue to which a packet is sent; and two bits for drop precedence (namely color) which is used by Random Early Detection (RED) to control traffic congestion.

PARAMETERS

These parameters are displayed:

- ◆ **CoS** – CoS value in ingress packets. (Range: 0-7)
- ◆ **CFI** – Canonical Format Indicator. Set to this parameter to "0" to indicate that the MAC address information carried in the frame is in canonical format. (Range: 0-1)

- ◆ **PHB** – Per-hop behavior, or the priority used for this router hop. (Range: 0-7)
- ◆ **Drop Precedence** – Drop precedence used for Random Early Detection in controlling traffic congestion. (Range: 0 - Green, 3 - Yellow, 1 - Red)

Table 18: Default Mapping of CoS/CFI to Internal PHB/Drop Precedence

CoS	CFI	0	1
0		(0,0)	(0,0)
1		(1,0)	(1,0)
2		(2,0)	(2,0)
3		(3,0)	(3,0)
4		(4,0)	(4,0)
5		(5,0)	(5,0)
6		(6,0)	(6,0)
7		(7,0)	(7,0)

WEB INTERFACE

To map CoS/CFI values to internal PHB/drop precedence:

1. Click Traffic, Priority, CoS to DSCP.
2. Select Configure from the Action list.
3. Set the PHB and drop precedence for any of the CoS/CFI combinations.
4. Click Apply.

Figure 135: Configuring CoS to DSCP Internal Mapping

Traffic > Priority > CoS to DSCP

Action: Add

CoS (0-7)

CFI (0-1)

PHB (0-7)

Drop Precedence

Apply Revert

To show the CoS/CFI to internal PHB/drop precedence map:

1. Click Traffic, Priority, CoS to DSCP.
2. Select Show from the Action list.

Figure 136: Showing CoS to DSCP Internal Mapping

Traffic > Priority > CoS to DSCP

Action: Show

CoS to DSCP Mapping List Total: 16

<input type="checkbox"/>	CoS	CFI	PHB	Drop Precedence
<input type="checkbox"/>	0	0	0	0
<input type="checkbox"/>	0	1	0	0
<input type="checkbox"/>	1	0	1	0
<input type="checkbox"/>	1	1	1	0
<input type="checkbox"/>	2	0	2	0
<input type="checkbox"/>	2	1	2	0
<input type="checkbox"/>	3	0	3	0
<input type="checkbox"/>	3	1	3	0
<input type="checkbox"/>	4	0	4	0
<input type="checkbox"/>	4	1	4	0

This chapter describes the following tasks required to apply QoS policies:

Class Map – Creates a map which identifies a specific class of traffic.

Policy Map – Sets the boundary parameters used for monitoring inbound traffic, and the action to take for conforming and non-conforming traffic.

Binding to a Port – Applies a policy map to an ingress port.

OVERVIEW

The commands described in this section are used to configure Quality of Service (QoS) classification criteria and service policies. Differentiated Services (DiffServ) provides policy-based management mechanisms used for prioritizing network resources to meet the requirements of specific traffic types on a per hop basis. Each packet is classified upon entry into the network based on access lists, IP Precedence, DSCP values, VLAN lists, or CoS values. Using access lists allows you select traffic based on Layer 2, Layer 3, or Layer 4 information contained in each packet. Based on configured network policies, different kinds of traffic can be marked for different kinds of forwarding.

All switches or routers that access the Internet rely on class information to provide the same forwarding treatment to packets in the same class. Class information can be assigned by end hosts, or switches or routers along the path. Priority can then be assigned based on a general policy, or a detailed examination of the packet. However, note that detailed examination of packets should take place close to the network edge so that core switches and routers are not overloaded.

Switches and routers along the path can use class information to prioritize the resources allocated to different traffic classes. The manner in which an individual device handles traffic in the DiffServ architecture is called per-hop behavior. All devices along a path should be configured in a consistent manner to construct a consistent end-to-end QoS solution.



NOTE: You can configure up to 16 rules per class map. You can also include multiple classes in a policy map.

NOTE: You should create a class map before creating a policy map. Otherwise, you will not be able to select a class map from the policy rule settings screen (see [page 291](#)).

COMMAND USAGE

To create a service policy for a specific category or ingress traffic, follow these steps:

1. Use the Configure Class (Add) page to designate a class name for a specific category of traffic.
2. Use the Configure Class (Add Rule) page to edit the rules for each class which specify a type of traffic based on an access list, a DSCP or IP Precedence value, a VLAN, or a CoS value.
3. Use the Configure Policy (Add) page to designate a policy name for a specific manner in which ingress traffic will be handled.
4. Use the Configure Policy (Add Rule) page to add one or more classes to the policy map. Assign policy rules to each class by "setting" the QoS value (CoS or PHB) to be assigned to the matching traffic class. The policy rule can also be configured to monitor the maximum throughput and burst rate. Then specify the action to take for conforming traffic, or the action to take for a policy violation.
5. Use the Configure Interface page to assign a policy map to a specific interface.

CONFIGURING A CLASS MAP

A class map is used for matching packets to a specified class. Use the Traffic > DiffServ (Configure Class) page to configure a class map.

CLI REFERENCES

- ◆ ["Quality of Service Commands" on page 1207](#)

COMMAND USAGE

- ◆ The class map is used with a policy map ([page 291](#)) to create a service policy ([page 301](#)) for a specific interface that defines packet classification, service tagging, and bandwidth policing. Note that one or more class maps can be assigned to a policy map.
- ◆ Up to 32 class maps can be configured.

PARAMETERS

These parameters are displayed:

Add

- ◆ **Class Name** – Name of the class map. (Range: 1-32 characters)
- ◆ **Type** – The criteria specified by the match command.
 - **Match All** – Match all conditions within a class map.
 - **Match Any** – Match any condition within a class map.

- ◆ **Description** – A brief description of a class map. (Range: 1-64 characters)

Add Rule

- ◆ **Class Name** – Name of the class map.
- ◆ **Type** – The criteria specified by the match command. (This field is set on the Add page.)
- ◆ **ACL** – Name of an access control list. Any type of ACL can be specified, including standard or extended IPv4/IPv6 ACLs and MAC ACLs.
- ◆ **IP DSCP** – A DSCP value. (Range: 0-63)
- ◆ **IP Precedence** – An IP Precedence value. (Range: 0-7)
- ◆ **IPv6 DSCP** – A DSCP value contained in an IPv6 packet. (Range: 0-63)
- ◆ **VLAN ID** – A VLAN. (Range:1-4094)
- ◆ **CoS** – A CoS value. (Range: 0-7)

WEB INTERFACE

To configure a class map:

1. Click Traffic, DiffServ.
2. Select Configure Class from the Step list.
3. Select Add from the Action list.
4. Enter a class name.
5. Set the Type to match any rule or all rules.
6. Enter a description.
7. Click Add.

Figure 137: Configuring a Class Map

Traffic > DiffServ

Step: 1. Configure Class Action: Add

Class Name: rd-class

Type: Match Any

Description: class for software group

Apply Revert

To show the configured class maps:

1. Click Traffic, DiffServ.
2. Select Configure Class from the Step list.
3. Select Show from the Action list.

Figure 138: Showing Class Maps

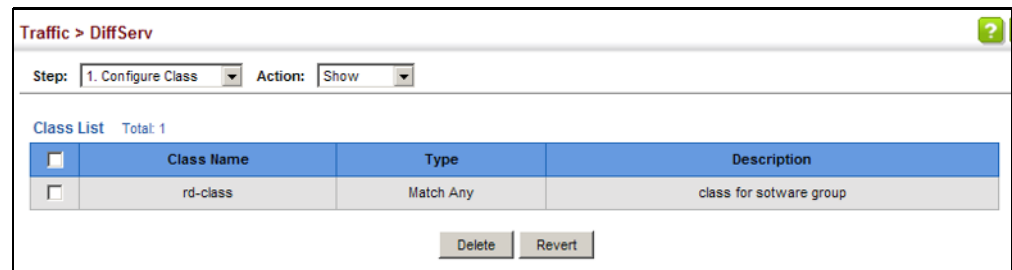

To edit the rules for a class map:

1. Click Traffic, DiffServ.
2. Select Configure Class from the Step list.
3. Select Add Rule from the Action list.
4. Select the name of a class map.
5. Specify type of traffic for this class based on an access list, a DSCP or IP Precedence value, a VLAN, or a CoS value. You can specify up to 16 items to match when assigning ingress traffic to a class map.
6. Click Apply.

Figure 139: Adding Rules to a Class Map

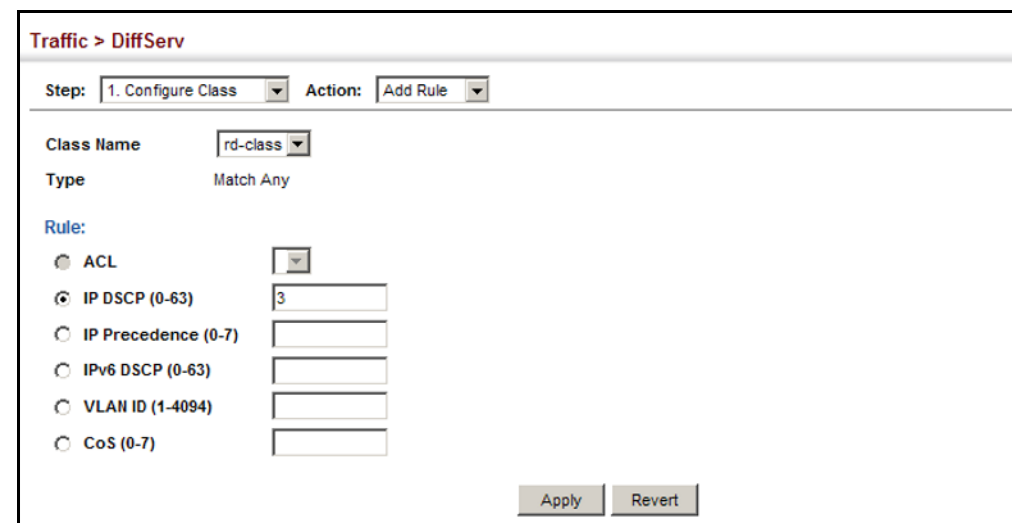

To show the rules for a class map:

1. Click Traffic, DiffServ.
2. Select Configure Class from the Step list.
3. Select Show Rule from the Action list.

Figure 140: Showing the Rules for a Class Map

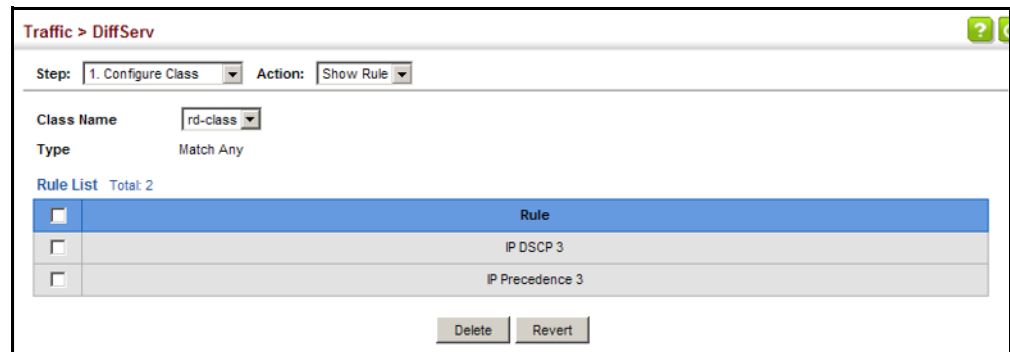

CREATING QoS POLICIES

Use the Traffic > DiffServ (Configure Policy) page to create a policy map that can be attached to multiple interfaces. A policy map is used to group one or more class map statements ([page 288](#)), modify service tagging, and enforce bandwidth policing. A policy map can then be bound by a service policy to one or more interfaces ([page 301](#)).

Configuring QoS policies requires several steps. A class map must first be configured which indicates how to match the inbound packets according to an access list, a DSCP or IP Precedence value, or a member of specific VLAN. A policy map is then configured which indicates the boundary parameters used for monitoring inbound traffic, and the action to take for conforming and non-conforming traffic. A policy map may contain one or more classes based on previously defined class maps.

The class of service or per-hop behavior (i.e., the priority used for internal queue processing) can be assigned to matching packets. In addition, the flow rate of inbound traffic can be monitored and the response to conforming and non-conforming traffic based by one of three distinct policing methods as described below.

Police Flow Meter – Defines the committed information rate (maximum throughput), committed burst size (burst rate), and the action to take for conforming and non-conforming traffic.

Policing is based on a token bucket, where bucket depth (that is, the maximum burst before the bucket overflows) is specified by the "burst" field (BC), and the average rate tokens are removed from the bucket is specified by the "rate" option (CIR). Action may be taken for traffic

conforming to the maximum throughput, or exceeding the maximum throughput.

srTCM Police Meter – Defines an enforcer for classified traffic based on a single rate three color meter scheme defined in RFC 2697. This metering policy monitors a traffic stream and processes its packets according to the committed information rate (CIR, or maximum throughput), committed burst size (BC, or burst rate), and excess burst size (BE). Action may taken for traffic conforming to the maximum throughput, exceeding the maximum throughput, or exceeding the excess burst size.

- ◆ The PHB label is composed of five bits, three bits for per-hop behavior, and two bits for the color scheme used to control queue congestion. In addition to the actions defined by this command to transmit, remark the DSCP service value, or drop a packet, the switch will also mark the two color bits used to set the drop precedence of a packet for Random Early Detection. A packet is marked green if it doesn't exceed the committed information rate and committed burst size, yellow if it does exceed the committed information rate and committed burst size, but not the excess burst size, and red otherwise.
- ◆ The meter operates in one of two modes. In the color-blind mode, the meter assumes that the packet stream is uncolored. In color-aware mode the meter assumes that some preceding entity has pre-colored the incoming packet stream so that each packet is either green, yellow, or red. The marker (re)colors an IP packet according to the results of the meter. The color is coded in the DS field [RFC 2474] of the packet.
- ◆ The behavior of the meter is specified in terms of its mode and two token buckets, C and E, which both share the common rate CIR. The maximum size of the token bucket C is BC and the maximum size of the token bucket E is BE.

The token buckets C and E are initially full, that is, the token count $T_c(0) = BC$ and the token count $T_e(0) = BE$. Thereafter, the token counts T_c and T_e are updated CIR times per second as follows:

- If T_c is less than BC, T_c is incremented by one, else
- if T_e is less than BE, T_e is incremented by one, else
- neither T_c nor T_e is incremented.

When a packet of size B bytes arrives at time t, the following happens if srTCM is configured to operate in Color-Blind mode:

- If $T_c(t) - B \geq 0$, the packet is green and T_c is decremented by B down to the minimum value of 0, else
- if $T_e(t) - B \geq 0$, the packets is yellow and T_e is decremented by B down to the minimum value of 0,
- else the packet is red and neither T_c nor T_e is decremented.

When a packet of size B bytes arrives at time t , the following happens if srTCM is configured to operate in Color-Aware mode:

- If the packet has been precolored as green and $T_c(t) - B \geq 0$, the packet is green and T_c is decremented by B down to the minimum value of 0, else
- If the packet has been precolored as yellow or green and if $T_e(t) - B \geq 0$, the packets is yellow and T_e is decremented by B down to the minimum value of 0, else
- the packet is red and neither T_c nor T_e is decremented.

The metering policy guarantees a deterministic behavior where the volume of green packets is never smaller than what has been determined by the CIR and BC, that is, tokens of a given color are always spent on packets of that color. Refer to RFC 2697 for more information on other aspects of srTCM.

trTCM Police Meter – Defines an enforcer for classified traffic based on a two rate three color meter scheme defined in RFC 2698. This metering policy monitors a traffic stream and processes its packets according to the committed information rate (CIR, or maximum throughput), peak information rate (PIR), and their associated burst sizes – committed burst size (BC, or burst rate), and peak burst size (BP). Action may taken for traffic conforming to the maximum throughput, exceeding the maximum throughput, or exceeding the peak burst size.

- ◆ The PHB label is composed of five bits, three bits for per-hop behavior, and two bits for the color scheme used to control queue congestion. In addition to the actions defined by this command to transmit, remark the DSCP service value, or drop a packet, the switch will also mark the two color bits used to set the drop precedence of a packet for Random Early Detection. A packet is marked red if it exceeds the PIR. Otherwise it is marked either yellow or green depending on whether it exceeds or doesn't exceed the CIR.

The trTCM is useful for ingress policing of a service, where a peak rate needs to be enforced separately from a committed rate.

- ◆ The meter operates in one of two modes. In the color-blind mode, the meter assumes that the packet stream is uncolored. In color-aware mode the meter assumes that some preceding entity has pre-colored the incoming packet stream so that each packet is either green, yellow, or red. The marker (re)colors an IP packet according to the results of the meter. The color is coded in the DS field [RFC 2474] of the packet.
- ◆ The behavior of the meter is specified in terms of its mode and two token buckets, P and C , which are based on the rates PIR and CIR, respectively. The maximum size of the token bucket P is BP and the maximum size of the token bucket C is BC .

The token buckets P and C are initially (at time 0) full, that is, the token count $T_p(0) = BP$ and the token count $T_c(0) = BC$. Thereafter, the token

count T_p is incremented by one PIR times per second up to BP and the token count T_c is incremented by one CIR times per second up to BC.

When a packet of size B bytes arrives at time t , the following happens if trTCM is configured to operate in Color-Blind mode:

- If $T_p(t)-B < 0$, the packet is red, else
- if $T_c(t)-B < 0$, the packet is yellow and T_p is decremented by B , else
- the packet is green and both T_p and T_c are decremented by B .

When a packet of size B bytes arrives at time t , the following happens if trTCM is configured to operate in Color-Aware mode:

- If the packet has been precolored as red or if $T_p(t)-B < 0$, the packet is red, else
 - if the packet has been precolored as yellow or if $T_c(t)-B < 0$, the packet is yellow and T_p is decremented by B , else
 - the packet is green and both T_p and T_c are decremented by B .
- ◆ The trTCM can be used to mark a IP packet stream in a service, where different, decreasing levels of assurances (either absolute or relative) are given to packets which are green, yellow, or red. Refer to RFC 2698 for more information on other aspects of trTCM.

CLI REFERENCES

- ◆ ["Quality of Service Commands" on page 1207](#)

COMMAND USAGE

- ◆ A policy map can contain 200 class statements that can be applied to the same interface ([page 301](#)). Up to 32 policy maps can be configured for ingress ports.
- ◆ After using the policy map to define packet classification, service tagging, and bandwidth policing, it must be assigned to a specific interface by a service policy ([page 301](#)) to take effect.

PARAMETERS

These parameters are displayed:

Add

- ◆ **Policy Name** – Name of policy map. (Range: 1-32 characters)
- ◆ **Description** – A brief description of a policy map. (Range: 1-64 characters)

Add Rule

- ◆ **Policy Name** – Name of policy map.
- ◆ **Class Name** – Name of a class map that defines a traffic classification upon which a policy can act.
- ◆ **Action** – This attribute is used to set an internal QoS value in hardware for matching packets. The PHB label is composed of five bits, three bits for per-hop behavior, and two bits for the color scheme used to control queue congestion with the srTCM and trTCM metering functions.
 - **Set CoS** – Configures the service provided to ingress traffic by setting an internal CoS value for a matching packet (as specified in rule settings for a class map). (Range: 0-7)

See [Table 18, "Default Mapping of CoS/CFI to Internal PHB/Drop Precedence," on page 284](#)).
 - **Set PHB** – Configures the service provided to ingress traffic by setting the internal per-hop behavior for a matching packet (as specified in rule settings for a class map). (Range: 0-7)

See [Table 17, "Default Mapping of DSCP Values to Internal PHB/Drop Values," on page 282](#)).
 - **Set IP DSCP** – Configures the service provided to ingress traffic by setting an IP DSCP value for a matching packet (as specified in rule settings for a class map). (Range: 0-63)
- ◆ **Meter** – Check this to define the maximum throughput, burst rate, and the action that results from a policy violation.
- ◆ **Meter Mode** – Selects one of the following policing methods.
 - **Flow** (Police Flow) – Defines the committed information rate (CIR, or maximum throughput), committed burst size (BC, or burst rate), and the action to take for conforming and non-conforming traffic. Policing is based on a token bucket, where bucket depth (that is, the maximum burst before the bucket overflows) is specified by the "burst" field, and the average rate tokens are removed from the bucket is by specified by the "rate" option.
 - **Committed Information Rate** (CIR) – Committed rate in kilobits per second. (Range: 0-1000000 kbps at a granularity of 64 kbps or maximum port speed, whichever is lower)

The rate cannot exceed the configured interface speed.
 - **Committed Burst Size** (BC) – Committed burst in bytes. (Range: 0-16000000 bytes at a granularity of 4k bytes)

The burst size cannot exceed 16 Mbytes.

- **Conform** – Specifies that traffic conforming to the maximum rate (CIR) and committed burst size (BC) will be transmitted without any change to the DSCP service level.
 - **Transmit** – Transmits in-conformance traffic without any change to the DSCP service level.
- **Violate** – Specifies whether the traffic that committed maximum rate (CIR) or burst size (BC) will be dropped or the DSCP service level will be reduced.
 - **Set IP DSCP** – Decreases DSCP priority for out of conformance traffic. (Range: 0-63)
 - **Drop** – Drops out of conformance traffic.
- **srTCM (Police Meter)** – Defines the committed information rate (CIR, or maximum throughput), committed burst size (BC, or burst rate) and excess burst size (BE), and the action to take for traffic conforming to the maximum throughput, exceeding the maximum throughput but within the excess burst size, or exceeding the excess burst size. In addition to the actions defined by this command to transmit, remark the DSCP service value, or drop a packet, the switch will also mark the two color bits used to set the drop precedence of a packet for Random Early Detection.

The color modes include "Color-Blind" which assumes that the packet stream is uncolored, and "Color-Aware" which assumes that the incoming packets are pre-colored. The functional differences between these modes is described at the beginning of this section under "srTCM Police Meter."

- **Committed Information Rate (CIR)** – Committed rate in kilobits per second. (Range: 0-1000000 kbps at a granularity of 64 kbps or maximum port speed, whichever is lower)
The rate cannot exceed the configured interface speed.
- **Committed Burst Size (BC)** – Committed burst in bytes. (Range: 0-16000000 bytes at a granularity of 4k bytes)
The burst size cannot exceed 16 Mbytes.
- **Excess Burst Size (BE)** – Burst in excess of committed burst size. (Range: 0-16000000 bytes at a granularity of 4k bytes)
The burst size cannot exceed 16 Mbytes.
- **Conform** – Specifies that traffic conforming to the maximum rate (CIR) and committed burst size (BC) will be transmitted without any change to the DSCP service level.
 - **Transmit** – Transmits in-conformance traffic without any change to the DSCP service level.

- **Exceed** – Specifies whether traffic that exceeds the committed maximum rate (CIR) or burst size (BC) but is within the excess burst size (BE) will be dropped or the DSCP service level will be reduced.
 - **Set IP DSCP** – Decreases DSCP priority for out of conformance traffic. (Range: 0-63)
 - **Drop** – Drops out of conformance traffic.
- **Violate** – Specifies whether the traffic that exceeds the excess burst size (BE) will be dropped or the DSCP service level will be reduced.
 - **Set IP DSCP** – Decreases DSCP priority for out of conformance traffic. (Range: 0-63)
 - **Drop** – Drops out of conformance traffic.
- **trTCM (Police Meter)** – Defines the committed information rate (CIR, or maximum throughput), peak information rate (PIR), and their associated burst sizes – committed burst size (BC, or burst rate) and peak burst size (BP), and the action to take for traffic conforming to the maximum throughput, exceeding the maximum throughput but within the peak information rate, or exceeding the peak information rate. In addition to the actions defined by this command to transmit, remark the DSCP service value, or drop a packet, the switch will also mark the two color bits used to set the drop precedence of a packet for Random Early Detection.

The color modes include “Color-Blind” which assumes that the packet stream is uncolored, and “Color-Aware” which assumes that the incoming packets are pre-colored. The functional differences between these modes is described at the beginning of this section under “trTCM Police Meter.”

- **Committed Information Rate (CIR)** – Committed rate in kilobits per second. (Range: 0-1000000 kbps at a granularity of 64 kbps or maximum port speed, whichever is lower)
The rate cannot exceed the configured interface speed.
- **Committed Burst Size (BC)** – Committed burst in bytes. (Range: 0-16000000 bytes at a granularity of 4k bytes)
The burst size cannot exceed 16 Mbytes.
- **Peak Information Rate (PIR)** – Rate in kilobits per second. (Range: 0-1000000 kbps at a granularity of 64 kbps or maximum port speed, whichever is lower)
The rate cannot exceed the configured interface speed.
- **Peak Burst Size (BP)** – Burst size in bytes. (Range: 0-16000000 bytes at a granularity of 4k bytes)

The burst size cannot exceed 16 Mbytes.

- **Conform** – Specifies that traffic conforming to the committed maximum rate (CIR) and peak burst size (BP) will be transmitted without any change to the DSCP service level.
 - **Transmit** – Transmits in-conformance traffic without any change to the DSCP service level.
- **Exceed** – Specifies whether traffic that exceeds the maximum rate (CIR) but is within the peak information rate (PIR) will be dropped or the DSCP service level will be reduced.
 - **Set IP DSCP** – Decreases DSCP priority for out of conformance traffic. (Range: 0-63).
 - **Drop** – Drops out of conformance traffic.
- **Violate** – Specifies whether the traffic that exceeds the peak information rate (PIR) will be dropped or the DSCP service level will be reduced.
 - **Set IP DSCP** – Decreases DSCP priority for out of conformance traffic. (Range: 0-63).
 - **Drop** – Drops out of conformance traffic.

WEB INTERFACE

To configure a policy map:

1. Click Traffic, DiffServ.
2. Select Configure Policy from the Step list.
3. Select Add from the Action list.
4. Enter a policy name.
5. Enter a description.
6. Click Add.

Figure 141: Configuring a Policy Map

Traffic > DiffServ

Step: 2. Configure Policy Action: Add

Policy Name: rd-policy

Description: for the software group

Apply Revert

To show the configured policy maps:

1. Click Traffic, DiffServ.
2. Select Configure Policy from the Step list.
3. Select Show from the Action list.

Figure 142: Showing Policy Maps

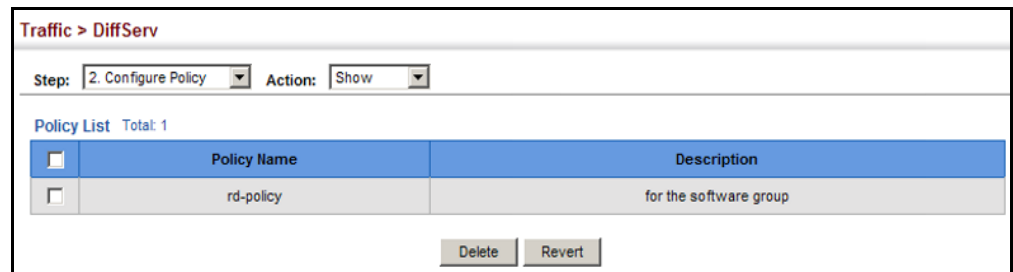

To edit the rules for a policy map:

1. Click Traffic, DiffServ.
2. Select Configure Policy from the Step list.
3. Select Add Rule from the Action list.
4. Select the name of a policy map.
5. Set the CoS or per-hop behavior for matching packets to specify the quality of service to be assigned to the matching traffic class. Use one of the metering options to define parameters such as the maximum throughput and burst rate. Then specify the action to take for conforming traffic, the action to tack for traffic in excess of the maximum rate but within the peak information rate, or the action to take for a policy violation.
6. Click Apply.

Figure 143: Adding Rules to a Policy Map

Traffic > DiffServ

Step: 2. Configure Policy Action: Add Rule

Policy Name: policy-rd

Rule:

Class Name: class-rd

Action: Set PHB (0-7) 3

Meter

Meter Mode: Flow

Committed Information Rate (0-1000000): 1000000 kbps

Committed Burst Size (0-16000000): 4000 bytes

Excess Burst Size (0-16000000): bytes

Peak Information Rate (0-1000000): kbps

Peak Burst Size (0-16000000): bytes

Conform: Transmit

Exceed: Set IP DSCP (0-63)

Violate: Drop

To show the rules for a policy map:

1. Click Traffic, DiffServ.
2. Select Configure Policy from the Step list.
3. Select Show Rule from the Action list.

Figure 144: Showing the Rules for a Policy Map

Traffic > DiffServ

Step: 2. Configure Policy Action: Show Rule

Policy Name: rd-policy

Rule List Total: 1

	Class Name	Action	Meter								
			Meter Mode	Committed Information Rate (kbps)	Committed Burst Size (bytes)	Exceeded Burst Size (bytes)	Peak Information Rate (kbps)	Peak Burst Size (bytes)	Conform	Exceed	Violate
<input type="checkbox"/>	rd-class	Set PHB 3	Flow	1000000	4000					Transmit	Drop

Buttons: Delete, Revert

ATTACHING A POLICY MAP TO A PORT

Use the Traffic > DiffServ (Configure Interface) page to bind a policy map to an ingress port.

CLI REFERENCES

- ◆ ["Quality of Service Commands" on page 1207](#)

COMMAND USAGE

- ◆ First define a class map, define a policy map, and then bind the service policy to the required interface.
- ◆ Only one policy map can be bound to an interface.
- ◆ The switch does not allow a policy map to be bound to an interface for egress traffic.

PARAMETERS

These parameters are displayed:

- ◆ **Port** – Specifies a port.
- ◆ **Ingress** – Applies the selected rule to ingress traffic.

WEB INTERFACE

To bind a policy map to a port:

1. Click Traffic, DiffServ.
2. Select Configure Interface from the Step list.
3. Check the box under the Ingress field to enable a policy map for a port.
4. Select a policy map from the scroll-down box.
5. Click Apply.

Figure 145: Attaching a Policy Map to a Port

Traffic > DiffServ

Step: 3. Configure Interface

Port Service Policy List Total: 52

Port	Ingress	Egress
1	<input type="checkbox"/> rd-policy	<input type="checkbox"/> rd-policy
2	<input type="checkbox"/> rd-policy	<input type="checkbox"/> rd-policy
3	<input type="checkbox"/> rd-policy	<input type="checkbox"/> rd-policy
4	<input type="checkbox"/> rd-policy	<input type="checkbox"/> rd-policy
5	<input type="checkbox"/> rd-policy	<input type="checkbox"/> rd-policy
6	<input type="checkbox"/> rd-policy	<input type="checkbox"/> rd-policy
7	<input type="checkbox"/> rd-policy	<input type="checkbox"/> rd-policy
8	<input type="checkbox"/> rd-policy	<input type="checkbox"/> rd-policy
9	<input type="checkbox"/> rd-policy	<input type="checkbox"/> rd-policy
10	<input type="checkbox"/> rd-policy	<input type="checkbox"/> rd-policy

Apply Revert

This chapter covers the following topics:

- ◆ [Global Settings](#) – Enables VOIP globally, sets the Voice VLAN, and the aging time for attached ports.
- ◆ [Telephony OUI List](#) – Configures the list of phones to be treated as VOIP devices based on the specified Organization Unit Identifier (OUI).
- ◆ [Port Settings](#) – Configures the way in which a port is added to the Voice VLAN, the filtering of non-VoIP packets, the method of detecting VoIP traffic, and the priority assigned to voice traffic.

OVERVIEW

When IP telephony is deployed in an enterprise network, it is recommended to isolate the Voice over IP (VoIP) network traffic from other data traffic. Traffic isolation can provide higher voice quality by preventing excessive packet delays, packet loss, and jitter. This is best achieved by assigning all VoIP traffic to a single Voice VLAN.

The use of a Voice VLAN has several advantages. It provides security by isolating the VoIP traffic from other data traffic. End-to-end QoS policies and high priority can be applied to VoIP VLAN traffic across the network, guaranteeing the bandwidth it needs. VLAN isolation also protects against disruptive broadcast and multicast traffic that can seriously affect voice quality.

The switch allows you to specify a Voice VLAN for the network and set a CoS priority for the VoIP traffic. The VoIP traffic can be detected on switch ports by using the source MAC address of packets, or by using LLDP (IEEE 802.1AB) to discover connected VoIP devices. When VoIP traffic is detected on a configured port, the switch automatically assigns the port as a tagged member the Voice VLAN. Alternatively, switch ports can be manually configured.

CONFIGURING VOIP TRAFFIC

Use the Traffic > VoIP (Configure Global) page to configure the switch for VoIP traffic. First enable automatic detection of VoIP devices attached to the switch ports, then set the Voice VLAN ID for the network. The Voice VLAN aging time can also be set to remove a port from the Voice VLAN when VoIP traffic is no longer received on the port.

CLI REFERENCES

- ◆ ["Configuring Voice VLANs" on page 1186](#)

COMMAND USAGE

All ports are set to VLAN hybrid mode by default. Prior to enabling VoIP for a port (by setting the VoIP mode to Auto or Manual as described below), first ensure that VLAN membership is not set to access mode (see ["Adding Static Members to VLANs" on page 205](#)).

PARAMETERS

These parameters are displayed:

- ◆ **Auto Detection Status** – Enables the automatic detection of VoIP traffic on switch ports. (Default: Disabled)
- ◆ **Voice VLAN** – Sets the Voice VLAN ID for the network. Only one Voice VLAN is supported and it must already be created on the switch. (Range: 1-4094)
- ◆ **Voice VLAN Aging Time** – The time after which a port is removed from the Voice VLAN when VoIP traffic is no longer received on the port. (Range: 5-43200 minutes; Default: 1440 minutes)



NOTE: The Voice VLAN ID cannot be modified when the global Auto Detection Status is enabled.

WEB INTERFACE

To configure global settings for a Voice VLAN:

1. Click Traffic, VoIP.
2. Select Configure Global from the Step list.
3. Enable Auto Detection.
4. Specify the Voice VLAN ID.
5. Adjust the Voice VLAN Aging Time if required.
6. Click Apply.

Figure 146: Configuring a Voice VLAN

Traffic > VoIP

Step: 1. Configure Global

Auto Detection Status Enabled

Voice VLAN 1234

Voice VLAN Aging Time (5-43200) 3000 sec

Apply Revert

CONFIGURING TELEPHONY OUI

VoIP devices attached to the switch can be identified by the vendor's Organizational Unique Identifier (OUI) in the source MAC address of received packets. OUI numbers are assigned to vendors and form the first three octets of device MAC addresses. The MAC OUI numbers for VoIP equipment can be configured on the switch so that traffic from these devices is recognized as VoIP. Use the Traffic > VoIP (Configure OUI) page to configure this feature.

CLI REFERENCES

- ◆ ["Configuring Voice VLANs" on page 1186](#)

PARAMETERS

These parameters are displayed:

- ◆ **Telephony OUI** – Specifies a MAC address range to add to the list. (Format: xx-xx-xx-xx-xx-xx)
- ◆ **Mask** – Identifies a range of MAC addresses. Setting a mask of FF-FF-FF-00-00-00 identifies all devices with the same OUI (the first three octets). Other masks restrict the MAC address range. Setting a mask of FF-FF-FF-FF-FF-FF specifies a single MAC address. (Format: xx-xx-xx-xx-xx-xx or xxxxxxxxxxxx; Default: FF-FF-FF-00-00-00)
- ◆ **Description** – User-defined text that identifies the VoIP devices.

WEB INTERFACE

To configure MAC OUI numbers for VoIP equipment:

1. Click Traffic, VoIP.
2. Select Configure OUI from the Step list.
3. Select Add from the Action list.

4. Enter a MAC address that specifies the OUI for VoIP devices in the network.
5. Select a mask from the pull-down list to define a MAC address range.
6. Enter a description for the devices.
7. Click Apply.

Figure 147: Configuring an OUI Telephony List

Traffic > VoIP

Step: 2. Configure OUI Action: Add

Telephony OUI: 00-e0-bb-00-00-00

Mask: ff-ff-ff-00-00-00

Description: old phones

Apply Revert

To show the MAC OUI numbers used for VoIP equipment:

1. Click Traffic, VoIP.
2. Select Configure OUI from the Step list.
3. Select Show from the Action list.

Figure 148: Showing an OUI Telephony List

Traffic > VoIP

Step: 2. Configure OUI Action: Show

Telephony OUI List Total: 3

<input type="checkbox"/>	Telephony OUI	Mask	Description
<input type="checkbox"/>	00-E0-BB-00-00-00	FF-FF-FF-00-00-00	old phones
<input type="checkbox"/>	00-11-22-33-44-55	FF-FF-FF-00-00-00	new phones
<input type="checkbox"/>	00-98-76-54-32-10	FF-FF-FF-FF-FF-FF	Chris' phone

Delete Revert

CONFIGURING VOIP TRAFFIC PORTS

Use the Traffic > VoIP (Configure Interface) page to configure ports for VoIP traffic, you need to set the mode (Auto or Manual), specify the discovery method to use, and set the traffic priority. You can also enable security filtering to ensure that only VoIP traffic is forwarded on the Voice VLAN.

CLI REFERENCES

- ◆ "Configuring Voice VLANs" on page 1186

COMMAND USAGE

All ports are set to VLAN hybrid mode by default. Prior to enabling VoIP for a port (by setting the VoIP mode to Auto or Manual as described below), first ensure that VLAN membership is not set to access mode (see ["Adding Static Members to VLANs" on page 205](#)).

PARAMETERS

These parameters are displayed:

- ◆ **Mode** – Specifies if the port will be added to the Voice VLAN when VoIP traffic is detected. (Default: None)
 - **None** – The Voice VLAN feature is disabled on the port. The port will not detect VoIP traffic or be added to the Voice VLAN.
 - **Auto** – The port will be added as a tagged member to the Voice VLAN when VoIP traffic is detected on the port. You must select a method for detecting VoIP traffic, either OUI or 802.1AB (LLDP). When OUI is selected, be sure to configure the MAC address ranges in the Telephony OUI list.
 - **Manual** – The Voice VLAN feature is enabled on the port, but the port must be manually added to the Voice VLAN.
- ◆ **Security** – Enables security filtering that discards any non-VoIP packets received on the port that are tagged with the voice VLAN ID. VoIP traffic is identified by source MAC addresses configured in the Telephony OUI list, or through LLDP that discovers VoIP devices attached to the switch. Packets received from non-VoIP sources are dropped. (Default: Disabled)
- ◆ **Discovery Protocol** – Selects a method to use for detecting VoIP traffic on the port. (Default: OUI)
 - **OUI** – Traffic from VoIP devices is detected by the Organizationally Unique Identifier (OUI) of the source MAC address. OUI numbers are assigned to vendors and form the first three octets of a device MAC address. MAC address OUI numbers must be configured in the Telephony OUI list so that the switch recognizes the traffic as being from a VoIP device.
 - **LLDP** – Uses LLDP (IEEE 802.1AB) to discover VoIP devices attached to the port. LLDP checks that the "telephone bit" in the system capability TLV is turned on. See ["Link Layer Discovery Protocol" on page 427](#) for more information on LLDP.
- ◆ **Priority** – Defines a CoS priority for port traffic on the Voice VLAN. The priority of any received VoIP packet is overwritten with the new priority when the Voice VLAN feature is active for the port. (Range: 0-6; Default: 6)
- ◆ **Remaining Age** – Number of minutes before this entry is aged out. The Remaining Age starts to count down when the OUI's MAC address expires from the MAC address table. Therefore, the MAC address aging

time should be added to the overall aging time. For example, if you configure the MAC address table aging time to 30 seconds, and the voice VLAN aging time to 5 minutes, then after 5.5 minutes, a port will be removed from voice VLAN when VoIP traffic is no longer received on the port. Alternatively, if you clear the MAC address table manually, then the switch will also start counting down the Remaining Age.

WEB INTERFACE

To configure VoIP traffic settings for a port:

1. Click Traffic, VoIP.
2. Select Configure Interface from the Step list.
3. Configure any required changes to the VoIP settings each port.
4. Click Apply.

Figure 149: Configuring Port Settings for a Voice VLAN

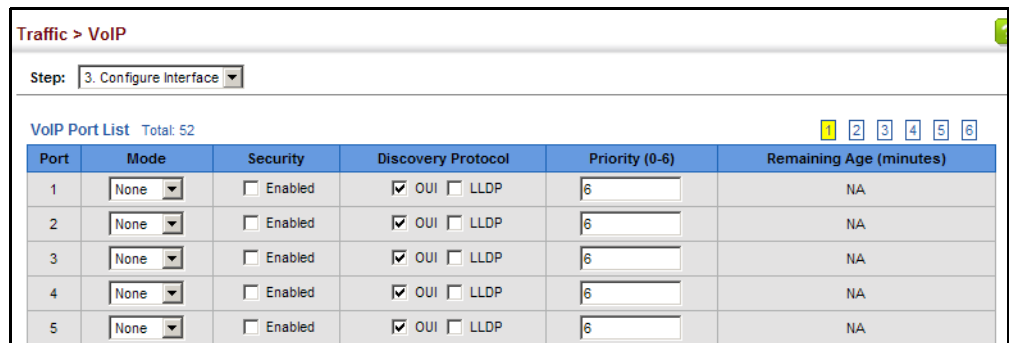

The screenshot shows a web interface for configuring VoIP settings. At the top, it says "Traffic > VoIP". Below that, there is a "Step:" dropdown menu set to "3. Configure Interface". Underneath, there is a "VoIP Port List" section with a "Total: 52" and a pagination bar showing "1 2 3 4 5 6". The main part of the interface is a table with the following columns: Port, Mode, Security, Discovery Protocol, Priority (0-6), and Remaining Age (minutes). The table contains five rows of data, all with "None" in the Mode column, "Enabled" in the Security column, "OUI" checked in the Discovery Protocol column, "6" in the Priority column, and "NA" in the Remaining Age column.

Port	Mode	Security	Discovery Protocol	Priority (0-6)	Remaining Age (minutes)
1	None	<input type="checkbox"/> Enabled	<input checked="" type="checkbox"/> OUI <input type="checkbox"/> LLDP	6	NA
2	None	<input type="checkbox"/> Enabled	<input checked="" type="checkbox"/> OUI <input type="checkbox"/> LLDP	6	NA
3	None	<input type="checkbox"/> Enabled	<input checked="" type="checkbox"/> OUI <input type="checkbox"/> LLDP	6	NA
4	None	<input type="checkbox"/> Enabled	<input checked="" type="checkbox"/> OUI <input type="checkbox"/> LLDP	6	NA
5	None	<input type="checkbox"/> Enabled	<input checked="" type="checkbox"/> OUI <input type="checkbox"/> LLDP	6	NA

You can configure this switch to authenticate users logging into the system for management access using local or remote authentication methods. Port-based authentication using IEEE 802.1X can also be configured to control either management access to the uplink ports or client access to the data ports. This switch provides secure network management access using the following options:

- ◆ [AAA](#) – Use local or remote authentication to configure access rights, specify authentication servers, configure remote authentication and accounting.
- ◆ [User Accounts](#) – Manually configure access rights on the switch for specified users.
- ◆ [Web Authentication](#) – Allows stations to authenticate and access the network in situations where 802.1X or Network Access authentication methods are infeasible or impractical.
- ◆ [Network Access](#) - Configure MAC authentication, intrusion response, dynamic VLAN assignment, and dynamic QoS assignment.
- ◆ [HTTPS](#) – Provide a secure web connection.
- ◆ [SSH](#) – Provide a secure shell (for secure Telnet access).
- ◆ [ACL](#) – Access Control Lists provide packet filtering for IP frames (based on address, protocol, Layer 4 protocol port number or TCP control code).
- ◆ [ARP Inspection](#) – Security feature that validates the MAC Address bindings for Address Resolution Protocol packets. Provides protection against ARP traffic with invalid MAC to IP Address bindings, which forms the basis for certain “man-in-the-middle” attacks.
- ◆ [IP Filter](#) – Filters management access to the web, SNMP or Telnet interface.
- ◆ [Port Security](#) – Configure secure addresses for individual ports.
- ◆ [Port Authentication](#) – Use IEEE 802.1X port authentication to control access to specific ports.
- ◆ [DoS Protection](#) – Protects against Denial-of-Service attacks.

- ◆ **IPv4 Source Guard** – Filters IPv4 traffic on insecure ports for which the source address cannot be identified via DHCPv4 snooping nor static source bindings.
- ◆ **IPv6 Source Guard** – Filters IPv6 traffic on insecure ports for which the source address cannot be identified via ND snooping, DHCPv6 snooping, nor static source bindings.
- ◆ **DHCP Snooping** – Filter IP traffic on insecure ports for which the source address cannot be identified via DHCP snooping.



NOTE: The priority of execution for the filtering commands is Port Security, Port Authentication, Network Access, Web Authentication, Access Control Lists, IP Source Guard, and then DHCP Snooping.

AAA AUTHENTICATION, AUTHORIZATION AND ACCOUNTING

The authentication, authorization, and accounting (AAA) feature provides the main framework for configuring access control on the switch. The three security functions can be summarized as follows:

- ◆ **Authentication** — Identifies users that request access to the network.
- ◆ **Authorization** — Determines if users can access specific services.
- ◆ **Accounting** — Provides reports, auditing, and billing for services that users have accessed on the network.

The AAA functions require the use of configured RADIUS or TACACS+ servers in the network. The security servers can be defined as sequential groups that are applied as a method for controlling user access to specified services. For example, when the switch attempts to authenticate a user, a request is sent to the first server in the defined group, if there is no response the second server will be tried, and so on. If at any point a pass or fail is returned, the process stops.

The switch supports the following AAA features:

- ◆ Accounting for IEEE 802.1X authenticated users that access the network through the switch.
- ◆ Accounting for users that access management interfaces on the switch through the console and Telnet.
- ◆ Accounting for commands that users enter at specific CLI privilege levels.
- ◆ Authorization of users that access management interfaces on the switch through the console and Telnet.

To configure AAA on the switch, you need to follow this general process:

1. Configure RADIUS and TACACS+ server access parameters. See ["Configuring Local/Remote Logon Authentication" on page 311](#).
2. Define RADIUS and TACACS+ server groups to support the accounting and authorization of services.
3. Define a method name for each service to which you want to apply accounting or authorization and specify the RADIUS or TACACS+ server groups to use.
4. Apply the method names to port or line interfaces.



NOTE: This guide assumes that RADIUS and TACACS+ servers have already been configured to support AAA. The configuration of RADIUS and TACACS+ server software is beyond the scope of this guide, refer to the documentation provided with the RADIUS or TACACS+ server software.

CONFIGURING LOCAL/ REMOTE LOGON AUTHENTICATION

Use the Security > AAA > System Authentication page to specify local or remote authentication. Local authentication restricts management access based on user names and passwords manually configured on the switch. Remote authentication uses a remote access authentication server based on RADIUS or TACACS+ protocols to verify management access.

CLI REFERENCES

- ◆ ["Authentication Sequence" on page 828](#)

COMMAND USAGE

- ◆ By default, management access is always checked against the authentication database stored on the local switch. If a remote authentication server is used, you must specify the authentication sequence. Then specify the corresponding parameters for the remote authentication protocol using the Security > AAA > Server page. Local and remote logon authentication control management access via the console port, web browser, or Telnet.
- ◆ You can specify up to three authentication methods for any user to indicate the authentication sequence. For example, if you select (1) RADIUS, (2) TACACS and (3) Local, the user name and password on the RADIUS server is verified first. If the RADIUS server is not available, then authentication is attempted using the TACACS+ server, and finally the local user name and password is checked.

PARAMETERS

These parameters are displayed:

- ◆ **Authentication Sequence** – Select the authentication, or authentication sequence required:
 - **Local** – User authentication is performed only locally by the switch.
 - **RADIUS** – User authentication is performed using a RADIUS server only.
 - **TACACS** – User authentication is performed using a TACACS+ server only.
 - [authentication sequence] – User authentication is performed by up to three authentication methods in the indicated sequence.

WEB INTERFACE

To configure the method(s) of controlling management access:

1. Click Security, AAA, System Authentication.
2. Specify the authentication sequence (i.e., one to three methods).
3. Click Apply.

Figure 150: Configuring the Authentication Sequence

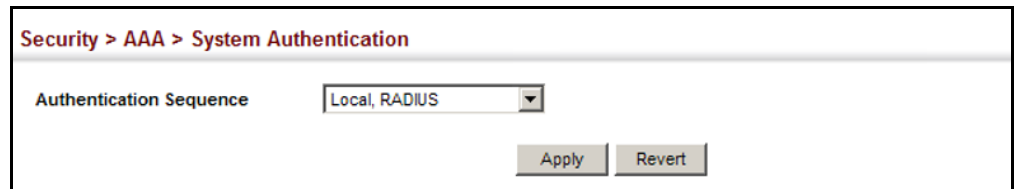

CONFIGURING REMOTE LOGON AUTHENTICATION SERVERS

Use the Security > AAA > Server page to configure the message exchange parameters for RADIUS or TACACS+ remote access authentication servers.

Remote Authentication Dial-in User Service (RADIUS) and Terminal Access Controller Access Control System Plus (TACACS+) are logon authentication protocols that use software running on a central server to control access to RADIUS-aware or TACACS-aware devices on the network. An authentication server contains a database of multiple user name/password pairs with associated privilege levels for each user that requires management access to the switch.

Figure 151: Authentication Server Operation

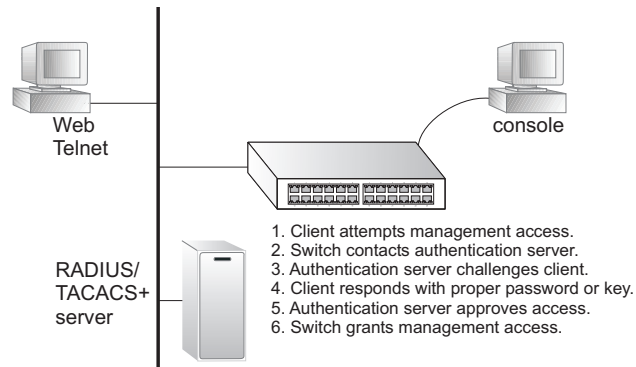

RADIUS uses UDP while TACACS+ uses TCP. UDP only offers best effort delivery, while TCP offers a more reliable connection-oriented transport. Also, note that RADIUS encrypts only the password in the access-request packet from the client to the server, while TACACS+ encrypts the entire body of the packet.

CLI REFERENCES

- ◆ "RADIUS Client" on page 830
- ◆ "TACACS+ Client" on page 834
- ◆ "AAA" on page 838

COMMAND USAGE

- ◆ If a remote authentication server is used, you must specify the message exchange parameters for the remote authentication protocol. Both local and remote logon authentication control management access via the console port, web browser, or Telnet.
- ◆ RADIUS and TACACS+ logon authentication assign a specific privilege level for each user name/password pair. The user name, password, and privilege level must be configured on the authentication server. The encryption methods used for the authentication process must also be configured or negotiated between the authentication server and logon client. This switch can pass authentication messages between the server and client that have been encrypted using MD5 (Message-Digest 5), TLS (Transport Layer Security), or TTLS (Tunneled Transport Layer Security).

PARAMETERS

These parameters are displayed:

Configure Server

◆ RADIUS

- **Global** – Provides globally applicable RADIUS settings.
- **Server Index** – Specifies one of five RADIUS servers that may be configured. The switch attempts authentication using the listed sequence of servers. The process ends when a server either approves or denies access to a user.

- **Server IP Address** – Address of authentication server.
(A Server Index entry must be selected to display this item.)
 - **Accounting Server UDP Port** – Network (UDP) port on authentication server used for accounting messages.
(Range: 1-65535; Default: 1813)
 - **Authentication Server UDP Port** – Network (UDP) port on authentication server used for authentication messages.
(Range: 1-65535; Default: 1812)
 - **Authentication Timeout** – The number of seconds the switch waits for a reply from the RADIUS server before it resends the request. (Range: 1-65535; Default: 5)
 - **Authentication Retries** – Number of times the switch tries to authenticate logon access via the authentication server.
(Range: 1-30; Default: 2)
 - **Set Key** – Mark this box to set or modify the encryption key.
 - **Authentication Key** – Encryption key used to authenticate logon access for client. Enclose any string containing blank spaces in double quotes. (Maximum length: 48 characters)
 - **Confirm Authentication Key** – Re-type the string entered in the previous field to ensure no errors were made. The switch will not change the encryption key if these two fields do not match.
- ◆ **TACACS+**
- **Global** – Provides globally applicable TACACS+ settings.
 - **Server Index** – Specifies the index number of the server to be configured. The switch currently supports only one TACACS+ server.
 - **Server IP Address** – Address of the TACACS+ server.
(A Server Index entry must be selected to display this item.)
 - **Authentication Server TCP Port** – Network (TCP) port of TACACS+ server used for authentication messages.
(Range: 1-65535; Default: 49)
 - **Authentication Timeout** – The number of seconds the switch waits for a reply from the TACACS+ server before it resends the request. (Range: 1-65535; Default: 5)
 - **Authentication Retries** – Number of times the switch tries to authenticate logon access via the authentication server.
(Range: 1-30; Default: 2)
 - **Set Key** – Mark this box to set or modify the encryption key.

- **Authentication Key** – Encryption key used to authenticate logon access for client. Enclose any string containing blank spaces in double quotes. (Maximum length: 48 characters)
- **Confirm Authentication Key** – Re-type the string entered in the previous field to ensure no errors were made. The switch will not change the encryption key if these two fields do not match.

Configure Group

- ◆ **Server Type** – Select RADIUS or TACACS+ server.
- ◆ **Group Name** - Defines a name for the RADIUS or TACACS+ server group. (Range: 1-64 characters)
- ◆ **Sequence at Priority** - Specifies the server and sequence to use for the group. (Range: 1-5 for RADIUS; 1 for TACACS)

When specifying the priority sequence for a sever, the server index must already be defined (see "[Configuring Local/Remote Logon Authentication](#)" on page 311).

WEB INTERFACE

To configure the parameters for RADIUS or TACACS+ authentication:

1. Click Security, AAA, Server.
2. Select Configure Server from the Step list.
3. Select RADIUS or TACACS+ server type.
4. Select Global to specify the parameters that apply globally to all specified servers, or select a specific Server Index to specify the parameters that apply to a specific server.
5. To set or modify the authentication key, mark the Set Key box, enter the key, and then confirm it
6. Click Apply.

Figure 152: Configuring Remote Authentication Server (RADIUS)

The screenshot shows the configuration page for a RADIUS server. The breadcrumb is "Security > AAA > Server". Under "Server Type", "RADIUS" is selected with a radio button, and "TACACS+" is unselected. Under "Server Index", "1" is selected with a radio button, and "2", "3", "4", and "5" are unselected. The "Global" radio button is unselected. The "Server IP Address" field contains "10.1.1.1". The "Accounting Server UDP Port (1-65535)" field contains "1813". The "Authentication Server UDP Port (1-65535)" field contains "1815". The "Authentication Timeout (1-65535)" field contains "10" with "sec" to its right. The "Authentication Retries (1-30)" field contains "5". There is a checked checkbox for "Set Key". The "Authentication Key" and "Confirm Authentication Key" fields both contain six dots. At the bottom right are "Apply" and "Revert" buttons.

Figure 153: Configuring Remote Authentication Server (TACACS+)

The screenshot shows the configuration page for a TACACS+ server. The breadcrumb is "Security > AAA > Server". Under "Server Type", "RADIUS" is unselected and "TACACS+" is selected with a radio button. Under "Server Index", "1" is selected with a radio button, and "2", "3", "4", and "5" are unselected. The "Global" radio button is unselected. The "Step:" dropdown menu is set to "1. Configure Server". The "Server IP Address" field contains "10.20.30.40". The "Authentication Server TCP Port (1-65535)" field contains "200". The "Authentication Timeout (1-540)" field contains "10" with "sec" to its right. The "Authentication Retries (1-30)" field contains "5". There is a checked checkbox for "Set Key". The "Authentication Key" and "Confirm Authentication Key" fields both contain six dots. At the bottom right are "Apply" and "Revert" buttons.

To configure the RADIUS or TACACS+ server groups to use for accounting and authorization:

1. Click Security, AAA, Server.
2. Select Configure Group from the Step list.
3. Select Add from the Action list.
4. Select RADIUS or TACACS+ server type.
5. Enter the group name, followed by the index of the server to use for each priority level.
6. Click Apply.

Figure 154: Configuring AAA Server Groups

The screenshot shows the configuration page for AAA Server Groups. The breadcrumb is "Security > AAA > Server". The "Step" is "2. Configure Group" and the "Action" is "Add". The "Server Type" is "RADIUS". The "RADIUS Group Name" is "radius". The sequence priorities are: Sequence At Priority 1: 1, Sequence At Priority 2: 3, Sequence At Priority 3: 5, Sequence At Priority 4: 2, and Sequence At Priority 5: None. There are "Apply" and "Revert" buttons at the bottom right.

To show the RADIUS or TACACS+ server groups used for accounting and authorization:

1. Click Security, AAA, Server.
2. Select Configure Group from the Step list.
3. Select Show from the Action list.

Figure 155: Showing AAA Server Groups

The screenshot shows the configuration page for AAA Server Groups with the "Action" set to "Show". The "Server Type" is "RADIUS". Below the configuration fields, there is a "RADIUS Group List" with a total of 3 groups. The table below shows the details of these groups.

	Group Name	Member Index
<input type="checkbox"/>	radius	1, 2, 3, 5
<input type="checkbox"/>	radius1	3, 5, 1
<input type="checkbox"/>	radius2	1, 2, 5

There are "Delete" and "Revert" buttons at the bottom right of the table.

**CONFIGURING
AAA ACCOUNTING**

Use the Security > AAA > Accounting page to enable accounting of requested services for billing or security purposes, and also to display the configured accounting methods, the methods applied to specific interfaces, and basic accounting information recorded for user sessions.

CLI REFERENCES

- ◆ "AAA" on page 838

COMMAND USAGE

AAA authentication through a RADIUS or TACACS+ server must be enabled before accounting is enabled.

PARAMETERS

These parameters are displayed:

Configure Global

- ◆ **Periodic Update** - Specifies the interval at which the local accounting service updates information for all users on the system to the accounting server. (Range: 1-2147483647 minutes)

Configure Method

- ◆ **Accounting Type** – Specifies the service as:
 - **802.1X** – Accounting for end users.
 - **Command** – Administrative accounting to apply to commands entered at specific CLI privilege levels.
 - **Exec** – Administrative accounting for local console, Telnet, or SSH connections.
- ◆ **Method Name** – Specifies an accounting method for service requests. The “default” methods are used for a requested service if no other methods have been defined. (Range: 1-64 characters)

Note that the method name is only used to describe the accounting method configured on the specified RADIUS or TACACS+ servers. No information is sent to the servers about the method to use.
- ◆ **Accounting Notice** – Records user activity from log-in to log-off point.
- ◆ **Server Group Name** - Specifies the accounting server group. (Range: 1-64 characters)

The group names “radius” and “tacacs+” specifies all configured RADIUS and TACACS+ hosts (see ["Configuring Local/Remote Logon Authentication" on page 311](#)). Any other group name refers to a server group configured on the Security > AAA > Server (Configure Group) page.

Configure Service

- ◆ **Accounting Type** – Specifies the service as 802.1X, Command or Exec as described in the preceding section.
- ◆ **802.1X**
 - **Method Name** – Specifies a user defined accounting method to apply to an interface. This method must be defined in the Configure Method page. (Range: 1-64 characters)
- ◆ **Command**
 - **Privilege Level** – The CLI privilege levels (0-15).

- **Console Method Name** – Specifies a user-defined method name to apply to commands entered at the specified CLI privilege level through the console interface.
- **VTY Method Name** – Specifies a user-defined method name to apply to commands entered at the specified CLI privilege level through Telnet or SSH.

◆ **Exec**

- **Console Method Name** – Specifies a user defined method name to apply to console connections.
- **VTY Method Name** – Specifies a user defined method name to apply to Telnet and SSH connections.

Show Information – Summary

- ◆ **Accounting Type** - Displays the accounting service.
- ◆ **Method Name** - Displays the user-defined or default accounting method.
- ◆ **Server Group Name** - Displays the accounting server group.
- ◆ **Interface** - Displays the port, console or Telnet interface to which these rules apply. (This field is null if the accounting method and associated server group has not been assigned to an interface.)

Show Information – Statistics

- ◆ **User Name** - Displays a registered user name.
- ◆ **Accounting Type** - Displays the accounting service.
- ◆ **Interface** - Displays the receive port number through which this user accessed the switch.
- ◆ **Time Elapsed** - Displays the length of time this entry has been active.

WEB INTERFACE

To configure global settings for AAA accounting:

1. Click Security, AAA, Accounting.
2. Select Configure Global from the Step list.
3. Enter the required update interval.
4. Click Apply.

Figure 156: Configuring Global Settings for AAA Accounting

Security > AAA > Accounting

Step: 1. Configure Global

Periodic Update (1-2147483647) 10 min

Apply Revert

To configure the accounting method applied to various service types and the assigned server group:

1. Click Security, AAA, Accounting.
2. Select Configure Method from the Step list.
3. Select Add from the Action list.
4. Select the accounting type (802.1X, Command, Exec).
5. Specify the name of the accounting method and server group name.
6. Click Apply.

Figure 157: Configuring AAA Accounting Methods

Security > AAA > Accounting

Step: 2. Configure Method Action: Add

Accounting Type 802.1X

Method Name default

Accounting Notice Start-Stop

Server Group Name radius

Apply Revert

To show the accounting method applied to various service types and the assigned server group:

1. Click Security, AAA, Accounting.
2. Select Configure Method from the Step list.
3. Select Show from the Action list.

Figure 158: Showing AAA Accounting Methods

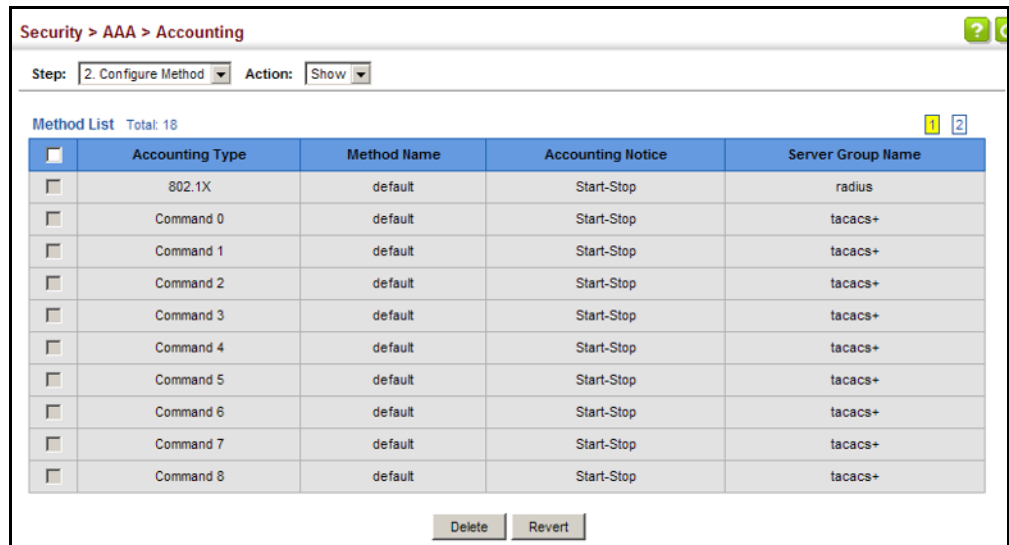

To configure the accounting method applied to specific interfaces, console commands entered at specific privilege levels, and local console, Telnet, or SSH connections:

1. Click Security, AAA, Accounting.
2. Select Configure Service from the Step list.
3. Select the accounting type (802.1X, Command, Exec).
4. Enter the required accounting method.
5. Click Apply.

Figure 159: Configuring AAA Accounting Service for 802.1X Service

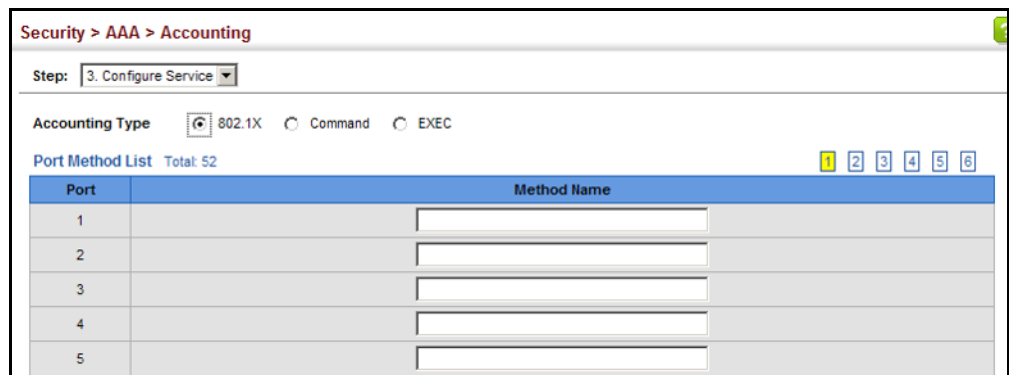

Figure 160: Configuring AAA Accounting Service for Exec Service

Security > AAA > Accounting

Step: 3. Configure Service

Accounting Type 802.1X Command EXEC

Console Method Name

VTY Method Name

Apply Revert

To display a summary of the configured accounting methods and assigned server groups for specified service types:

1. Click Security, AAA, Accounting.
2. Select Show Information from the Step list.
3. Click Summary.

Figure 161: Displaying a Summary of Applied AAA Accounting Methods

Security > AAA > Accounting

Step: 4. Show Information

Summary Statistics

Method List Total: 18

Accounting Type	Method Name	Server Group Name	Interface
802.1X	default	radius	
Command 0	default	tacacs+	
Command 1	default	tacacs+	
Command 2	default	tacacs+	
Command 3	default	tacacs+	
Command 4	default	tacacs+	
Command 5	default	tacacs+	
Command 6	default	tacacs+	
Command 7	default	tacacs+	
Command 8	default	tacacs+	

To display basic accounting information and statistics recorded for user sessions:

1. Click Security, AAA, Accounting.
2. Select Show Information from the Step list.
3. Click Statistics.

Figure 162: Displaying Statistics for AAA Accounting Sessions

The screenshot shows a web interface for displaying AAA Accounting Statistics. The breadcrumb is "Security > AAA > Accounting". The "Step" is "4. Show Information". There are two tabs: "Summary" (unselected) and "Statistics" (selected). Below the tabs, it says "Accounting Statistics Total: 2". A table displays the following data:

User Name	Accounting Type	Interface	Time Elapsed
Bob	802.1X	Eth1/1	3:44:55
Ted	802.1X	Eth1/5	1:24:51

CONFIGURING AAA AUTHORIZATION

Use the Security > AAA > Authorization page to enable authorization of requested services, and also to display the configured authorization methods, and the methods applied to specific interfaces.

CLI REFERENCES

- ◆ "AAA" on page 838

COMMAND USAGE

- ◆ This feature performs authorization to determine if a user is allowed to run an Exec shell.
- ◆ AAA authentication through a RADIUS or TACACS+ server must be enabled before authorization is enabled.

PARAMETERS

These parameters are displayed:

Configure Method

- ◆ **Authorization Type** – Specifies the service as:
 - **Command** – Administrative authorization to apply to commands entered at specific CLI privilege levels.
 - **Exec** – Administrative authorization for local console, Telnet, or SSH connections.
- ◆ **Method Name** – Specifies an authorization method for service requests. The "default" method is used for a requested service if no other methods have been defined. (Range: 1-64 characters)
- ◆ **Server Group Name** - Specifies the authorization server group. (Range: 1-64 characters)

The group name "tacacs+" specifies all configured TACACS+ hosts (see ["Configuring Local/Remote Logon Authentication" on page 311](#)). Any other group name refers to a server group configured on the TACACS+ Group Settings page. Authorization is only supported for TACACS+ servers.

Configure Service

- ◆ **Authorization Type** - Specifies EXEC authorization, or Command authorization for specific CLI privilege levels.
- ◆ **Console Method Name** - Specifies a user defined method name to apply to console connections.
- ◆ **VTY Method Name** - Specifies a user defined method name to apply to Telnet and SSH connections.

Show Information

- ◆ **Authorization Type** - Displays the authorization service.
- ◆ **Method Name** - Displays the user-defined or default accounting method.
- ◆ **Server Group Name** - Displays the authorization server group.
- ◆ **Interface** - Displays the console or Telnet interface to which these rules apply. (This field is null if the authorization method and associated server group has not been assigned to an interface.)

WEB INTERFACE

To configure the authorization method applied to the Exec service type and the assigned server group:

1. Click Security, AAA, Authorization.
2. Select Configure Method from the Step list.
3. Specify the name of the authorization method and server group name.
4. Click Apply.

Figure 163: Configuring AAA Authorization Methods

Security > AAA > Authorization

Step: 1. Configure Method Action: Add

Authorization Type: EXEC

Method Name: default

Server Group Name: tacacs+

Apply Revert

To show the authorization method applied to the EXEC service type and the assigned server group:

1. Click Security, AAA, Authorization.
2. Select Configure Method from the Step list.
3. Select Show from the Action list.

Figure 164: Showing AAA Authorization Methods

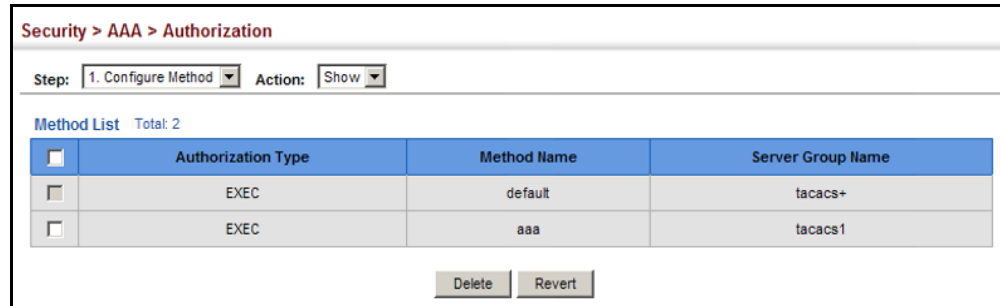

To configure the authorization method applied to local console, Telnet, or SSH connections:

1. Click Security, AAA, Authorization.
2. Select Configure Service from the Step list.
3. Enter the required authorization method.
4. Click Apply.

Figure 165: Configuring AAA Authorization Methods for Exec Service

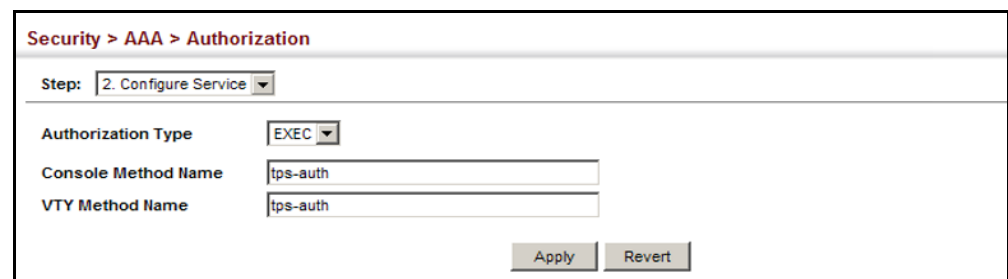

To display a the configured authorization method and assigned server groups for The Exec service type:

1. Click Security, AAA, Authorization.
2. Select Show Information from the Step list.

Figure 166: Displaying the Applied AAA Authorization Method

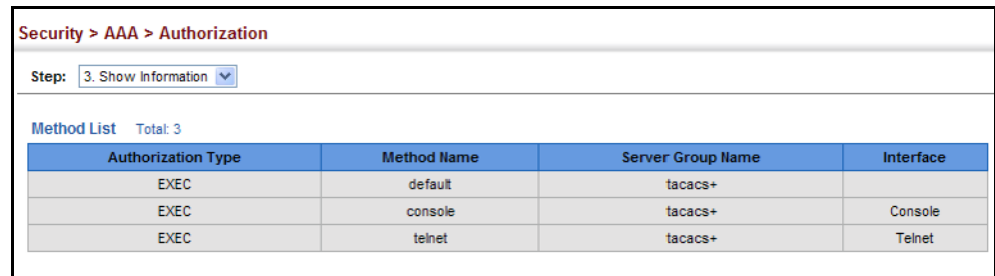

The screenshot shows the 'Security > AAA > Authorization' page. At the top, there is a breadcrumb trail and a 'Step:' dropdown menu set to '3. Show Information'. Below this is a 'Method List' section with a 'Total: 3' indicator. The table below lists three authorization methods:

Authorization Type	Method Name	Server Group Name	Interface
EXEC	default	tacacs+	
EXEC	console	tacacs+	Console
EXEC	telnet	tacacs+	Telnet

CONFIGURING USER ACCOUNTS

Use the Security > User Accounts page to control management access to the switch based on manually configured user names and passwords.

CLI REFERENCES

- ◆ ["User Accounts and Privilege Levels" on page 824](#)

COMMAND USAGE

- ◆ The default guest name is "guest" with the password "guest." The default administrator name is "admin" with the password "admin."
- ◆ The guest only has read access for most configuration parameters. However, the administrator has write access for all parameters governing the onboard agent. You should therefore assign a new administrator password as soon as possible, and store it in a safe place.

PARAMETERS

These parameters are displayed:

- ◆ **User Name** – The name of the user.
(Maximum length: 32 characters; maximum number of users: 16)
- ◆ **Access Level** – Specifies command access privileges. (Range: 0-15)
Level 0, 8 and 15 are designed for users (guest), managers (network maintenance), and administrators (top-level access). The other levels can be used to configured specialized access profiles.
Level 0-7 provide the same default access to a limited number of commands which display the current status of the switch, as well as several database clear and reset functions. These commands are equivalent to those available under Normal Exec command mode in the CLI.

Level 8-14 provide the same default access privileges, including additional commands beyond those provided for Levels 0-7 (equivalent to CLI Normal Exec command mode), and a subset of the configuration commands provided for Level 15 (equivalent to CLI Privileged Exec command mode).

Level 15 provides full access to all commands.

The privilege level associated with any command can be changed using the `privilege` command.

Any privilege level can access all of the commands assigned to lower privilege levels. For example, privilege level 8 can access all commands assigned to privilege levels 7-0 according to default settings, and to any other commands assigned to levels 7-0 using the `privilege` command.

◆ **Password Type** – Specifies the following options.

- **No Password** – No password is required for this user to log in.
- **Plain Password** – Plain text unencrypted password.
- **Encrypted Password** – Encrypted password.

The encrypted password is required for compatibility with legacy password settings (i.e., plain text or encrypted) when reading the configuration file during system bootup or when downloading the configuration file from a TFTP or FTP server. There is no need for you to manually configure encrypted passwords.

◆ **Password** – Specifies the user password. (Range: 0-32 characters, case sensitive)

◆ **Confirm Password** – Re-type the string entered in the previous field to ensure no errors were made. The switch will not change the password if these two fields do not match.

WEB INTERFACE

To configure user accounts:

1. Click Security, User Accounts.
2. Select Add from the Action list.
3. Specify a user name, select the user's access level, then enter a password if required and confirm it.
4. Click Apply.

Figure 167: Configuring User Accounts

Security > User Accounts

Action: Add

User Name: bob

Access Level: 15 (Privileged)

Password Type: Plain Password

Password:

Confirm Password:

Apply Revert

To show user accounts:

1. Click Security, User Accounts.
2. Select Show from the Action list.

Figure 168: Showing User Accounts

Security > User Accounts

Action: Show

User Account List Total: 3

<input type="checkbox"/>	User Name	Access Level
<input type="checkbox"/>	admin	15
<input type="checkbox"/>	guest	0
<input type="checkbox"/>	bob	15

Delete Revert

WEB AUTHENTICATION

Web authentication allows stations to authenticate and access the network in situations where 802.1X or Network Access authentication are infeasible or impractical. The web authentication feature allows unauthenticated hosts to request and receive a DHCP assigned IP address and perform DNS queries. All other traffic, except for HTTP protocol traffic, is blocked. The switch intercepts HTTP protocol traffic and redirects it to a switch-generated web page that facilitates user name and password authentication via RADIUS. Once authentication is successful, the web browser is forwarded on to the originally requested web page. Successful authentication is valid for all hosts connected to the port.



NOTE: RADIUS authentication must be activated and configured properly for the web authentication feature to work properly. (See "[Configuring Local/Remote Logon Authentication](#)" on page 311.)

NOTE: Web authentication cannot be configured on trunk ports.

CONFIGURING GLOBAL SETTINGS FOR WEB AUTHENTICATION

Use the Security > Web Authentication (Configure Global) page to edit the global parameters for web authentication.

CLI REFERENCES

- ◆ "[Web Authentication](#)" on page 909

PARAMETERS

These parameters are displayed:

- ◆ **Web Authentication Status** – Enables web authentication for the switch. (Default: Disabled)

Note that this feature must also be enabled for any port where required under the Configure Interface menu.
- ◆ **Session Timeout** – Configures how long an authenticated session stays active before it must re-authenticate itself. (Range: 300-3600 seconds; Default: 3600 seconds)
- ◆ **Quiet Period** – Configures how long a host must wait to attempt authentication again after it has exceeded the maximum allowable failed login attempts. (Range: 1-180 seconds; Default: 60 seconds)
- ◆ **Login Attempts** – Configures the amount of times a supplicant may attempt and fail authentication before it must wait the configured quiet period. (Range: 1-3 attempts; Default: 3 attempts)

WEB INTERFACE

To configure global parameters for web authentication:

1. Click Security, Web Authentication.
2. Select Configure Global from the Step list.
3. Enable web authentication globally on the switch, and adjust any of the protocol parameters as required.
4. Click Apply.

Figure 169: Configuring Global Settings for Web Authentication

Security > Web Authentication

Step: 1. Configure Global

Web Authentication Status Enabled

Session Timeout (300-3600) 3600 sec

Quiet Period (1-180) 60 sec

Login Attempts (1-3) 3

Apply Revert

CONFIGURING INTERFACE SETTINGS FOR WEB AUTHENTICATION

Use the Security > Web Authentication (Configure Interface) page to enable web authentication on a port, and display information for any connected hosts.

CLI REFERENCES

- ◆ ["Web Authentication" on page 909](#)

PARAMETERS

These parameters are displayed:

- ◆ **Port** – Indicates the port being configured.
- ◆ **Status** – Configures the web authentication status for the port.
- ◆ **Host IP Address** – Indicates the IP address of each connected host.
- ◆ **Remaining Session Time** – Indicates the remaining time until the current authorization session for the host expires.
- ◆ **Apply** – Enables web authentication if the Status box is checked.
- ◆ **Revert** – Restores the previous configuration settings.
- ◆ **Re-authenticate** – Ends all authenticated web sessions for selected host IP addresses in the Authenticated Host List, and forces the users to re-authenticate.

WEB INTERFACE

To enable web authentication for a port:

1. Click Security, Web Authentication.
2. Select Configure Interface from the Step list.
3. Set the status box to enabled for any port that requires web authentication, and click Apply

4. Mark the check box for any host addresses that need to be re-authenticated, and click Re-authenticate.

Figure 170: Configuring Interface Settings for Web Authentication

Security > Web Authentication

Step: 2. Configure Interface

Port: 1

Status: Enabled

Apply Revert

Authenticated Host List Total: 2

<input type="checkbox"/>	Host IP Address	Remaining Session Time (sec)
<input type="checkbox"/>	10.1.1.1	300
<input type="checkbox"/>	10.2.2.2	100

Re-authenticate Revert

NETWORK ACCESS (MAC ADDRESS AUTHENTICATION)

Some devices connected to switch ports may not be able to support 802.1X authentication due to hardware or software limitations. This is often true for devices such as network printers, IP phones, and some wireless access points. The switch enables network access from these devices to be controlled by authenticating device MAC addresses with a central RADIUS server.



NOTE: RADIUS authentication must be activated and configured properly for the MAC Address authentication feature to work properly. (See ["Configuring Remote Logon Authentication Servers"](#) on page 312.)

NOTE: MAC authentication cannot be configured on trunk ports.

CLI REFERENCES

- ◆ ["Network Access \(MAC Address Authentication\)"](#) on page 895

COMMAND USAGE

- ◆ MAC address authentication controls access to the network by authenticating the MAC address of each host that attempts to connect to a switch port. Traffic received from a specific MAC address is forwarded by the switch only if the source MAC address is successfully authenticated by a central RADIUS server. While authentication for a MAC address is in progress, all traffic is blocked until authentication is completed. On successful authentication, the RADIUS server may optionally assign VLAN and quality of service settings for the switch port.
- ◆ When enabled on a port, the authentication process sends a Password Authentication Protocol (PAP) request to a configured RADIUS server. The user name and password are both equal to the MAC address being

authenticated. On the RADIUS server, PAP user name and passwords must be configured in the MAC address format XX-XX-XX-XX-XX-XX (all in upper case).

- ◆ Authenticated MAC addresses are stored as dynamic entries in the switch secure MAC address table and are removed when the aging time expires. The maximum number of secure MAC addresses supported for the switch system is 1024.
- ◆ Configured static MAC addresses are added to the secure address table when seen on a switch port. Static addresses are treated as authenticated without sending a request to a RADIUS server.
- ◆ When port status changes to down, all MAC addresses mapped to that port are cleared from the secure MAC address table. Static VLAN assignments are not restored.
- ◆ The RADIUS server may optionally return a VLAN identifier list to be applied to the switch port. The following attributes need to be configured on the RADIUS server.
 - **Tunnel-Type** = VLAN
 - **Tunnel-Medium-Type** = 802
 - **Tunnel-Private-Group-ID** = 1u,2t [VLAN ID list]

The VLAN identifier list is carried in the RADIUS "Tunnel-Private-Group-ID" attribute. The VLAN list can contain multiple VLAN identifiers in the format "1u,2t,3u" where "u" indicates an untagged VLAN and "t" a tagged VLAN.

- ◆ The RADIUS server may optionally return dynamic QoS assignments to be applied to a switch port for an authenticated user. The "Filter-ID" attribute (attribute 11) can be configured on the RADIUS server to pass the following QoS information:

Table 19: Dynamic QoS Profiles

Profile	Attribute Syntax	Example
DiffServ	service-policy-in = <i>policy-map-name</i>	service-policy-in=p1
Rate Limit	rate-limit-input = <i>rate</i>	rate-limit-input=100 (Kbps)
	rate-limit-output = <i>rate</i>	rate-limit-output=200 (Kbps)
802.1p	switchport-priority-default = <i>value</i>	switchport-priority-default=2
IP ACL	ip-access-group-in = <i>ip-acl-name</i>	ip-access-group-in=ipV4acl
IPv6 ACL	ipv6-access-group-in = <i>ipv6-acl-name</i>	ipv6-access-group-in=ipV6acl
MAC ACL	mac-access-group-in = <i>mac-acl-name</i>	mac-access-group-in=macAcl

- ◆ Multiple profiles can be specified in the Filter-ID attribute by using a semicolon to separate each profile.

For example, the attribute "service-policy-in=pp1;rate-limit-input=100" specifies that the diffserv profile name is "pp1," and the ingress rate limit profile value is 100 kbps.

- ◆ If duplicate profiles are passed in the Filter-ID attribute, then only the first profile is used.
For example, if the attribute is "service-policy-in=p1;service-policy-in=p2", then the switch applies only the DiffServ profile "p1."
- ◆ Any unsupported profiles in the Filter-ID attribute are ignored.
For example, if the attribute is "map-ip-dscp=2:3;service-policy-in=p1," then the switch ignores the "map-ip-dscp" profile.
- ◆ When authentication is successful, the dynamic QoS information may not be passed from the RADIUS server due to one of the following conditions (authentication result remains unchanged):
 - The Filter-ID attribute cannot be found to carry the user profile.
 - The Filter-ID attribute is empty.
 - The Filter-ID attribute format for dynamic QoS assignment is unrecognizable (can not recognize the whole Filter-ID attribute).
- ◆ Dynamic QoS assignment fails and the authentication result changes from success to failure when the following conditions occur:
 - Illegal characters found in a profile value (for example, a non-digital character in an 802.1p profile value).
 - Failure to configure the received profiles on the authenticated port.
- ◆ When the last user logs off on a port with a dynamic QoS assignment, the switch restores the original QoS configuration for the port.
- ◆ When a user attempts to log into the network with a returned dynamic QoS profile that is different from users already logged on to the same port, the user is denied access.
- ◆ While a port has an assigned dynamic QoS profile, any manual QoS configuration changes only take effect after all users have logged off the port.

CONFIGURING GLOBAL SETTINGS FOR NETWORK ACCESS

MAC address authentication is configured on a per-port basis, however there are two configurable parameters that apply globally to all ports on the switch. Use the Security > Network Access (Configure Global) page to configure MAC address authentication aging and reauthentication time.

CLI REFERENCES

- ◆ ["Network Access \(MAC Address Authentication\)" on page 895](#)

PARAMETERS

These parameters are displayed:

- ◆ **Aging Status** – Enables aging for authenticated MAC addresses stored in the secure MAC address table. (Default: Disabled)

This parameter applies to authenticated MAC addresses configured by the MAC Address Authentication process described in this section, as well as to any secure MAC addresses authenticated by 802.1X, regardless of the 802.1X Operation Mode (Single-Host, Multi-Host, or MAC-Based authentication as described on [page 390](#)).

Authenticated MAC addresses are stored as dynamic entries in the switch's secure MAC address table and are removed when the aging time expires.

The maximum number of secure MAC addresses supported for the switch system is 1024.

- ◆ **Reauthentication Time** – Sets the time period after which a connected host must be reauthenticated. When the reauthentication time expires for a secure MAC address, it is reauthenticated with the RADIUS server. During the reauthentication process traffic through the port remains unaffected. (Range: 120-1000000 seconds; Default: 1800 seconds)

WEB INTERFACE

To configure aging status and reauthentication time for MAC address authentication:

1. Click Security, Network Access.
2. Select Configure Global from the Step list.
3. Enable or disable aging for secure addresses, and modify the reauthentication time as required.
4. Click Apply.

Figure 171: Configuring Global Settings for Network Access

The screenshot shows a web interface for configuring network access settings. At the top, it says "Security > Network Access". Below that, there is a "Step:" dropdown menu currently set to "1. Configure Global". The main configuration area has two rows: "Aging Status" with a checked checkbox and the text "Enabled", and "Reauthentication Time (120-1000000)" with a text input field containing "30000" and the unit "sec". At the bottom right of the configuration area are two buttons: "Apply" and "Revert".

CONFIGURING NETWORK ACCESS FOR PORTS

Use the Security > Network Access (Configure Interface - General) page to configure MAC authentication on switch ports, including enabling address authentication, setting the maximum MAC count, and enabling dynamic VLAN or dynamic QoS assignments.

CLI REFERENCES

- ◆ "[Network Access \(MAC Address Authentication\)](#)" on page 895

PARAMETERS

These parameters are displayed:

◆ **MAC Authentication**

- **Status** – Enables MAC authentication on a port. (Default: Disabled)
- **Intrusion** – Sets the port response to a host MAC authentication failure to either block access to the port or to pass traffic through. (Options: Block, Pass; Default: Block)
- **Max MAC Count**⁶ – Sets the maximum number of MAC addresses that can be authenticated on a port via MAC authentication; that is, the Network Access process described in this section. (Range: 1-1024; Default: 1024)

- ◆ **Network Access Max MAC Count**⁵ – Sets the maximum number of MAC addresses that can be authenticated on a port interface via all forms of authentication (including Network Access and IEEE 802.1X). (Range: 1-2048; Default: 1024)

- ◆ **Guest VLAN** – Specifies the VLAN to be assigned to the port when 802.1X Authentication or MAC authentication fails. (Range: 0-4094, where 0 means disabled; Default: Disabled)

The VLAN must already be created and active (see "[Configuring VLAN Groups](#)" on page 202). Also, when used with 802.1X authentication, intrusion action must be set for "Guest VLAN" (see "[Configuring Port Authenticator Settings for 802.1X](#)" on page 390).

- ◆ **Dynamic VLAN** – Enables dynamic VLAN assignment for an authenticated port. When enabled, any VLAN identifiers returned by the RADIUS server through the 802.1X authentication process are applied to the port, providing the VLANs have already been created on the switch. (GVRP is not used to create the VLANs.) (Default: Enabled)

The VLAN settings specified by the first authenticated MAC address are implemented for a port. Other authenticated MAC addresses on the port must have the same VLAN configuration, or they are treated as authentication failures.

If dynamic VLAN assignment is enabled on a port and the RADIUS server returns no VLAN configuration, the authentication is still treated as a success, and the host is assigned to the default untagged VLAN.

When the dynamic VLAN assignment status is changed on a port, all authenticated addresses mapped to that port are cleared from the secure MAC address table.

- ◆ **Dynamic QoS** – Enables dynamic QoS assignment for an authenticated port. (Default: Disabled)

- ◆ **MAC Filter ID** – Allows a MAC Filter to be assigned to the port. MAC addresses or MAC address ranges present in a selected MAC Filter are

6. The maximum number of MAC addresses per port is 1024, and the maximum number of secure MAC addresses supported for the switch system is 1024. When the limit is reached, all new MAC addresses are treated as authentication failures.

exempt from authentication on the specified port (as described under "Configuring a MAC Address Filter"). (Range: 1-64; Default: None)

WEB INTERFACE

To configure MAC authentication on switch ports:

1. Click Security, Network Access.
2. Select Configure Interface from the Step list.
3. Click the General button.
4. Make any configuration changes required to enable address authentication on a port, set the maximum number of secure addresses supported, the guest VLAN to use when MAC Authentication or 802.1X Authentication fails, and the dynamic VLAN and QoS assignments.
5. Click Apply.

Figure 172: Configuring Interface Settings for Network Access

Port	MAC Authentication			Network Access Max MAC Count (1-2048)	Guest VLAN (0-4093, 0: Disabled)	Dynamic VLAN	Dynamic QoS	MAC Filter ID (1-64)
	Status	Intrusion	Max MAC Count (1-1024)					
1	<input type="checkbox"/> Enabled	Block	1024	1024	0	<input checked="" type="checkbox"/> Enabled	<input type="checkbox"/> Enabled	<input type="checkbox"/>
2	<input checked="" type="checkbox"/> Enabled	Block	1024	1024	0	<input checked="" type="checkbox"/> Enabled	<input type="checkbox"/> Enabled	<input type="checkbox"/>
3	<input type="checkbox"/> Enabled	Block	1024	1024	0	<input checked="" type="checkbox"/> Enabled	<input type="checkbox"/> Enabled	<input type="checkbox"/>
4	<input type="checkbox"/> Enabled	Block	1024	1024	0	<input checked="" type="checkbox"/> Enabled	<input type="checkbox"/> Enabled	<input type="checkbox"/>
5	<input type="checkbox"/> Enabled	Block	1024	1024	0	<input checked="" type="checkbox"/> Enabled	<input type="checkbox"/> Enabled	<input type="checkbox"/>

CONFIGURING PORT LINK DETECTION Use the Security > Network Access (Configure Interface - Link Detection) page to send an SNMP trap and/or shut down a port when a link event occurs.

CLI REFERENCES

- ◆ "Network Access (MAC Address Authentication)" on page 895

PARAMETERS

These parameters are displayed:

- ◆ **Link Detection Status** – Configures whether Link Detection is enabled or disabled for a port.
- ◆ **Condition** – The link event type which will trigger the port action.
 - **Link up** – Only link up events will trigger the port action.
 - **Link down** – Only link down events will trigger the port action.

- **Link up and down** – All link up and link down events will trigger the port action.
- ◆ **Action** – The switch can respond in three ways to a link up or down trigger event.
 - **Trap** – An SNMP trap is sent.
 - **Trap and shutdown** – An SNMP trap is sent and the port is shut down.
 - **Shutdown** – The port is shut down.

WEB INTERFACE

To configure link detection on switch ports:

1. Click Security, Network Access.
2. Select Configure Interface from the Step list.
3. Click the Link Detection button.
4. Modify the link detection status, trigger condition, and the response for any port.
5. Click Apply.

Figure 173: Configuring Link Detection for Network Access

Port	Link Detection Status	Condition	Action
1	<input type="checkbox"/> Enabled	Link down	Trap
2	<input checked="" type="checkbox"/> Enabled	Link up and down	Trap
3	<input type="checkbox"/> Enabled	Link down	Trap
4	<input type="checkbox"/> Enabled	Link down	Trap
5	<input type="checkbox"/> Enabled	Link down	Trap

**CONFIGURING A
MAC ADDRESS FILTER**

Use the Security > Network Access (Configure MAC Filter) page to designate specific MAC addresses or MAC address ranges as exempt from authentication. MAC addresses present in MAC Filter tables activated on a port are treated as pre-authenticated on that port.

CLI REFERENCES

- ◆ "Network Access (MAC Address Authentication)" on page 895

COMMAND USAGE

- ◆ Specified MAC addresses are exempt from authentication.

- ◆ Up to 65 filter tables can be defined.
- ◆ There is no limitation on the number of entries used in a filter table.

PARAMETERS

These parameters are displayed:

- ◆ **Filter ID** – Adds a filter rule for the specified filter. (Range: 1-64)
- ◆ **MAC Address** – The filter rule will check ingress packets against the entered MAC address or range of MAC addresses (as defined by the MAC Address Mask).
- ◆ **MAC Address Mask** – The filter rule will check for the range of MAC addresses defined by the MAC bit mask. If you omit the mask, the system will assign the default mask of an exact match. (Range: 000000000000 - FFFFFFFF; Default: FFFFFFFF)

WEB INTERFACE

To add a MAC address filter for MAC authentication:

1. Click Security, Network Access.
2. Select Configure MAC Filter from the Step list.
3. Select Add from the Action list.
4. Enter a filter ID, MAC address, and optional mask.
5. Click Apply.

Figure 174: Configuring a MAC Address Filter for Network Access

The screenshot shows a web interface for configuring a MAC address filter. At the top, it says "Security > Network Access". Below that, there are two dropdown menus: "Step: 3. Configure MAC Filter" and "Action: Add". The main configuration area has three input fields: "Filter ID (1-64)" with the value "22", "MAC Address" with the value "11-22-33-44-55-66", and "MAC Address Mask" with the value "FFFFFFFF". At the bottom right of the form, there are two buttons: "Apply" and "Revert".

To show the MAC address filter table for MAC authentication:

1. Click Security, Network Access.
2. Select Configure MAC Filter from the Step list.
3. Select Show from the Action list.

Figure 175: Showing the MAC Address Filter Table for Network Access

The screenshot shows the 'Security > Network Access' configuration page. At the top, there is a breadcrumb trail 'Security > Network Access'. Below it, there are two dropdown menus: 'Step: 3. Configure MAC Filter' and 'Action: Show'. The main content area is titled 'MAC Filter List Total: 1'. It contains a table with the following data:

<input type="checkbox"/>	Filter ID	MAC Address	MAC Address Mask
<input type="checkbox"/>	22	11-22-33-44-55-66	FF-FF-FF-FF-FF-FF

At the bottom of the table, there are two buttons: 'Delete' and 'Revert'.

DISPLAYING SECURE MAC ADDRESS INFORMATION

Use the Security > Network Access (Show Information) page to display the authenticated MAC addresses stored in the secure MAC address table. Information on the secure MAC entries can be displayed and selected entries can be removed from the table.

CLI REFERENCES

- ◆ ["Network Access \(MAC Address Authentication\)" on page 895](#)

PARAMETERS

These parameters are displayed:

- ◆ **Query By** – Specifies parameters to use in the MAC address query.
 - **Sort Key** – Sorts the information displayed based on MAC address, port interface, or attribute.
 - **MAC Address** – Specifies a specific MAC address.
 - **Interface** – Specifies a port interface.
 - **Attribute** – Displays static or dynamic addresses.
- ◆ **Authenticated MAC Address List**
 - **MAC Address** – The authenticated MAC address.
 - **Interface** – The port interface associated with a secure MAC address.
 - **RADIUS Server** – The IP address of the RADIUS server that authenticated the MAC address.
 - **Time** – The time when the MAC address was last authenticated.

- **Attribute** – Indicates a static or dynamic address.

WEB INTERFACE

To display the authenticated MAC addresses stored in the secure MAC address table:

1. Click Security, Network Access.
2. Select Show Information from the Step list.
3. Use the sort key to display addresses based MAC address, interface, or attribute.
4. Restrict the displayed addresses by entering a specific address in the MAC Address field, specifying a port in the Interface field, or setting the address type to static or dynamic in the Attribute field.
5. Click Query.

Figure 176: Showing Addresses Authenticated for Network Access

Security > Network Access

Step: 4. Show Information

Query by:

Sort Key: MAC Address

MAC Address

Interface

Attribute

Query

Authenticated MAC Address List Total: 6

<input type="checkbox"/>	MAC Address	Interface	RADIUS Server	Time	Attribute
<input type="checkbox"/>	00-00-86-45-F2-23	Unit 1 / Port 23	10.2.2.10	2008y 20m 12d 11h 16m 12s	Dynamic
<input type="checkbox"/>	00-00-E8-5E-E1-DD	Unit 1 / Port 23	10.2.2.10	2008y 20m 12d 11h 32m 24s	Dynamic
<input type="checkbox"/>	00-00-E8-81-93-30	Unit 1 / Port 23	10.2.2.10	2008y 20m 12d 11h 40m 32s	Dynamic
<input type="checkbox"/>	00-01-80-31-B8-30	Unit 1 / Port 23	10.2.2.10	2008y 20m 12d 11h 18m 51s	Dynamic
<input type="checkbox"/>	00-01-80-36-95-D8	Unit 1 / Port 23	10.2.2.10	2008y 20m 12d 11h 32m 22s	Dynamic

CONFIGURING HTTPS

You can configure the switch to enable the Secure Hypertext Transfer Protocol (HTTPS) over the Secure Socket Layer (SSL), providing secure access (i.e., an encrypted connection) to the switch's web interface.

CONFIGURING GLOBAL SETTINGS FOR HTTPS Use the Security > HTTPS (Configure Global) page to enable or disable HTTPS and specify the TCP port used for this service.

CLI REFERENCES

- ◆ ["Web Server" on page 847](#)

COMMAND USAGE

- ◆ Both the HTTP and HTTPS service can be enabled independently on the switch. However, you cannot configure both services to use the same TCP port. (HTTP can only be configured through the CLI using the [ip http server](#) command described on [page 848](#).)
- ◆ If you enable HTTPS, you must indicate this in the URL that you specify in your browser: `https://device[:port_number]`
- ◆ When you start HTTPS, the connection is established in this way:
 - The client authenticates the server using the server's digital certificate.
 - The client and server negotiate a set of security protocols to use for the connection.
 - The client and server generate session keys for encrypting and decrypting data.
- ◆ The client and server establish a secure encrypted connection.
A padlock icon should appear in the status bar for Internet Explorer 6, Mozilla Firefox 4, or Google Chrome 29, or more recent versions.
- ◆ The following web browsers and operating systems currently support HTTPS:

Table 20: HTTPS System Support

Web Browser	Operating System
Internet Explorer 6.x or later	Windows 98, Windows NT (with service pack 6a), Windows 2000, XP, Vista, 7, 8
Mozilla Firefox 4 or later	Windows 2000, XP, Vista, 7, 8, Linux
Google Chrome 29 or later	Windows XP, Vista, 7, 8

- ◆ To specify a secure-site certificate, see ["Replacing the Default Secure-site Certificate" on page 342](#).



NOTE: Users are automatically logged off of the HTTP server or HTTPS server if no input is detected for 600 seconds.

NOTE: Connection to the web interface is not supported for HTTPS using an IPv6 link local address.

PARAMETERS

These parameters are displayed:

- ◆ **HTTPS Status** – Allows you to enable/disable the HTTPS server feature on the switch. (Default: Enabled)
- ◆ **HTTPS Port** – Specifies the TCP port number used for HTTPS connection to the switch’s web interface. (Default: Port 443)

WEB INTERFACE

To configure HTTPS:

1. Click Security, HTTPS.
2. Select Configure Global from the Step list.
3. Enable HTTPS and specify the port number if required.
4. Click Apply.

Figure 177: Configuring HTTPS

Security > HTTPS

Action:

HTTPS Status Enabled

HTTPS Port (1-65535)

REPLACING THE DEFAULT SECURE-SITE CERTIFICATE

Use the Security > HTTPS (Copy Certificate) page to replace the default secure-site certificate.

When you log onto the web interface using HTTPS (for secure access), a Secure Sockets Layer (SSL) certificate appears for the switch. By default, the certificate that the web browser displays will be associated with a warning that the site is not recognized as a secure site. This is because the certificate has not been signed by an approved certification authority. If you want this warning to be replaced by a message confirming that the connection to the switch is secure, you must obtain a unique certificate and a private key and password from a recognized certification authority.



CAUTION: For maximum security, we recommend you obtain a unique Secure Sockets Layer certificate at the earliest opportunity. This is because the default certificate for the switch is not unique to the hardware you have purchased.

When you have obtained these, place them on your TFTP server and transfer them to the switch to replace the default (unrecognized) certificate with an authorized one.



NOTE: The switch must be reset for the new certificate to be activated. To reset the switch, see ["Resetting the System" on page 150](#) or type "reload" at the command prompt: `Console#reload`

CLI REFERENCES

- ◆ ["Web Server" on page 847](#)

PARAMETERS

These parameters are displayed:

- ◆ **TFTP Server IP Address** – IP address of TFTP server which contains the certificate file.
- ◆ **Certificate Source File Name** – Name of certificate file stored on the TFTP server.
- ◆ **Private Key Source File Name** – Name of private key file stored on the TFTP server.
- ◆ **Private Password** – Password stored in the private key file. This password is used to verify authorization for certificate use, and is verified when downloading the certificate to the switch.
- ◆ **Confirm Password** – Re-type the string entered in the previous field to ensure no errors were made. The switch will not download the certificate if these two fields do not match.

WEB INTERFACE

To replace the default secure-site certificate:

1. Click Security, HTTPS.
2. Select Copy Certificate from the Step list.
3. Fill in the TFTP server, certificate and private key file name, and private password.
4. Click Apply.

Figure 178: Downloading the Secure-Site Certificate

The screenshot shows a web interface for configuring HTTPS. The breadcrumb is "Security > HTTPS". The "Action:" dropdown menu is set to "Copy Certificate". Below this are five input fields: "TFTP Server IP Address" with the value "192.168.0.4", "Certificate Source File Name" with "ES3510MA-site-certificate", "Private Key Source File Name" with "ES3510MA-private-key", "Private Password" with a masked password of seven dots, and "Confirm Password" with a masked password of seven dots. At the bottom right are "Apply" and "Revert" buttons.

CONFIGURING THE SECURE SHELL

The Berkeley-standard includes remote access tools originally designed for Unix systems. Some of these tools have also been implemented for Microsoft Windows and other environments. These tools, including commands such as *rlogin* (remote login), *rsh* (remote shell), and *rcp* (remote copy), are not secure from hostile attacks.

Secure Shell (SSH) includes server/client applications intended as a secure replacement for the older Berkeley remote access tools. SSH can also provide remote management access to this switch as a secure replacement for Telnet. When the client contacts the switch via the SSH protocol, the switch generates a public-key that the client uses along with a local user name and password for access authentication. SSH also encrypts all data transfers passing between the switch and SSH-enabled management station clients, and ensures that data traveling over the network arrives unaltered.



NOTE: You need to install an SSH client on the management station to access the switch for management via the SSH protocol.

NOTE: The switch supports both SSH Version 1.5 and 2.0 clients.

COMMAND USAGE

The SSH server on this switch supports both password and public key authentication. If password authentication is specified by the SSH client, then the password can be authenticated either locally or via a RADIUS or TACACS+ remote authentication server, as specified on the System Authentication page ([page 311](#)). If public key authentication is specified by the client, then you must configure authentication keys on both the client and the switch as described in the following section. Note that regardless of whether you use public key or password authentication, you still have to generate authentication keys on the switch (SSH Host Key Settings) and enable the SSH server (Authentication Settings).

To use the SSH server, complete these steps:

1. *Generate a Host Key Pair* – On the SSH Host Key Settings page, create a host public/private key pair.
2. *Provide Host Public Key to Clients* – Many SSH client programs automatically import the host public key during the initial connection setup with the switch. Otherwise, you need to manually create a known hosts file on the management station and place the host public key in it. An entry for a public key in the known hosts file would appear similar to the following example:

```
10.1.0.54 1024 35
15684995401867669259333946775054617325313674890836547254
15020245593199868544358361651999923329781766065830956
10825913212890233 76546801726272571413428762941301196195566782
59566410486957427888146206519417467729848654686157177393901647
79355942303577413098022737087794545240839717526463580581767167
09574804776117
```

3. *Import Client's Public Key to the Switch* – See "[Importing User Public Keys](#)" on [page 350](#), or use the `copy tftp public-key` command ([page 738](#)) to copy a file containing the public key for all the SSH client's granted management access to the switch. (Note that these clients must be configured locally on the switch via the User Accounts page as described on [page 326](#).) The clients are subsequently authenticated using these keys. The current firmware only accepts public key files based on standard UNIX format as shown in the following example for an RSA Version 1 key:

```
1024 35
13410816856098939210409449201554253476316419218729589211431738
80055536161631051775940838686311092912322268285192543746031009
37187721199696317813662774141689851320491172048303392543241016
37997592371449011938006090253948408482717819437228840253311595
2134861022902978982721353267131629432532818915045306393916643
steve@192.168.1.19
```

4. *Set the Optional Parameters* – On the SSH Settings page, configure the optional parameters, including the authentication timeout, the number of retries, and the server key size.

5. *Enable SSH Service* – On the SSH Settings page, enable the SSH server on the switch.
6. *Authentication* – One of the following authentication methods is employed:
 - Password Authentication (for SSH v1.5 or V2 Clients)*
 - a. The client sends its password to the server.
 - b. The switch compares the client's password to those stored in memory.
 - c. If a match is found, the connection is allowed.



NOTE: To use SSH with only password authentication, the host public key must still be given to the client, either during initial connection or manually entered into the known host file. However, you do not need to configure the client's keys.

Public Key Authentication – When an SSH client attempts to contact the switch, the SSH server uses the host key pair to negotiate a session key and encryption method. Only clients that have a private key corresponding to the public keys stored on the switch can access it. The following exchanges take place during this process:

Authenticating SSH v1.5 Clients

- a. The client sends its RSA public key to the switch.
- b. The switch compares the client's public key to those stored in memory.
- c. If a match is found, the switch uses its secret key to generate a random 256-bit string as a challenge, encrypts this string with the user's public key, and sends it to the client.
- d. The client uses its private key to decrypt the challenge string, computes the MD5 checksum, and sends the checksum back to the switch.
- e. The switch compares the checksum sent from the client against that computed for the original string it sent. If the two checksums match, this means that the client's private key corresponds to an authorized public key, and the client is authenticated.

Authenticating SSH v2 Clients

- a. The client first queries the switch to determine if DSA public key authentication using a preferred algorithm is acceptable.
- b. If the specified algorithm is supported by the switch, it notifies the client to proceed with the authentication process. Otherwise, it rejects the request.
- c. The client sends a signature generated using the private key to the switch.
- d. When the server receives this message, it checks whether the supplied key is acceptable for authentication, and if so, it then

checks whether the signature is correct. If both checks succeed, the client is authenticated.



NOTE: The SSH server supports up to eight client sessions. The maximum number of client sessions includes both current Telnet sessions and SSH sessions.

NOTE: The SSH server can be accessed using any configured IPv4 or IPv6 interface address on the switch.

CONFIGURING THE SSH SERVER

Use the Security > SSH (Configure Global) page to enable the SSH server and configure basic settings for authentication.



NOTE: A host key pair must be configured on the switch before you can enable the SSH server. See ["Generating the Host Key Pair" on page 348](#).

CLI REFERENCES

- ◆ ["Secure Shell" on page 853](#)

PARAMETERS

These parameters are displayed:

- ◆ **SSH Server Status** – Allows you to enable/disable the SSH server on the switch. (Default: Disabled)
- ◆ **Version** – The Secure Shell version number. Version 2.0 is displayed, but the switch supports management access via either SSH Version 1.5 or 2.0 clients.
- ◆ **Authentication Timeout** – Specifies the time interval in seconds that the SSH server waits for a response from a client during an authentication attempt. (Range: 1-120 seconds; Default: 120 seconds)
- ◆ **Authentication Retries** – Specifies the number of authentication attempts that a client is allowed before authentication fails and the client has to restart the authentication process. (Range: 1-5 times; Default: 3)
- ◆ **Server-Key Size** – Specifies the SSH server key size. (Range: 512-896 bits; Default: 768)
 - The server key is a private key that is never shared outside the switch.
 - The host key is shared with the SSH client, and is fixed at 1024 bits.

WEB INTERFACE

To configure the SSH server:

1. Click Security, SSH.
2. Select Configure Global from the Step list.
3. Enable the SSH server.
4. Adjust the authentication parameters as required.
5. Click Apply.

Figure 179: Configuring the SSH Server

The screenshot shows the 'Security > SSH' configuration page. At the top, there is a breadcrumb 'Security > SSH' and a 'Step:' dropdown menu set to '1. Configure Global'. Below this, there are several configuration fields: 'SSH Server Status' with a checked checkbox and the text 'Enabled'; 'Version' set to '2.0'; 'Authentication Timeout (1-120)' with a text input field containing '120' and the unit 'sec'; 'Authentication Retries (1-5)' with a text input field containing '3'; and 'Server-Key Size (512-896)' with a text input field containing '768'. At the bottom right of the configuration area, there are two buttons: 'Apply' and 'Revert'.

GENERATING THE HOST KEY PAIR

Use the Security > SSH (Configure Host Key - Generate) page to generate a host public/private key pair used to provide secure communications between an SSH client and the switch. After generating this key pair, you must provide the host public key to SSH clients and import the client's public key to the switch as described in the section ["Importing User Public Keys"](#) on page 350.



NOTE: A host key pair must be configured on the switch before you can enable the SSH server. See ["Configuring the SSH Server"](#) on page 347.

CLI REFERENCES

- ◆ ["Secure Shell"](#) on page 853

PARAMETERS

These parameters are displayed:

- ◆ **Host-Key Type** – The key type used to generate the host key pair (i.e., public and private keys). (Range: RSA (Version 1), DSA (Version 2), Both; Default: Both)

The SSH server uses RSA or DSA for key exchange when the client first establishes a connection with the switch, and then negotiates with the

client to select either DES (56-bit) or 3DES (168-bit) for data encryption.



NOTE: The switch uses only RSA Version 1 for SSHv1.5 clients and DSA Version 2 for SSHv2 clients.

- ◆ **Save Host-Key from Memory to Flash** – Saves the host key from RAM (i.e., volatile memory) to flash memory. Otherwise, the host key pair is stored to RAM by default. Note that you must select this item prior to generating the host-key pair. (Default: Disabled)

WEB INTERFACE

To generate the SSH host key pair:

1. Click Security, SSH.
2. Select Configure Host Key from the Step list.
3. Select Generate from the Action list.
4. Select the host-key type from the drop-down box.
5. Select the option to save the host key from memory to flash if required.
6. Click Apply.

Figure 180: Generating the SSH Host Key Pair

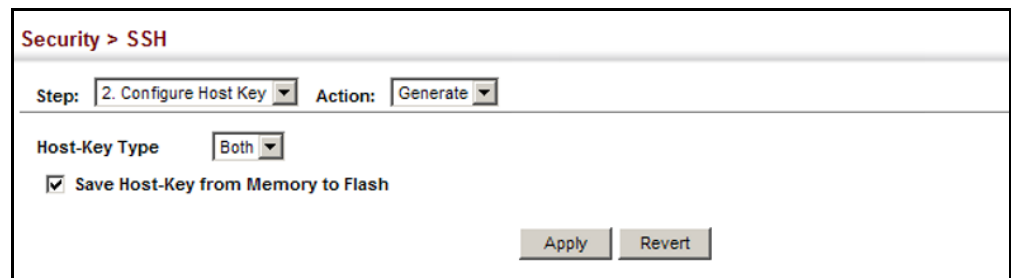

To display or clear the SSH host key pair:

1. Click Security, SSH.
2. Select Configure Host Key from the Step list.
3. Select Show from the Action list.
4. Select the host-key type to clear.
5. Click Clear.

Figure 181: Showing the SSH Host Key Pair

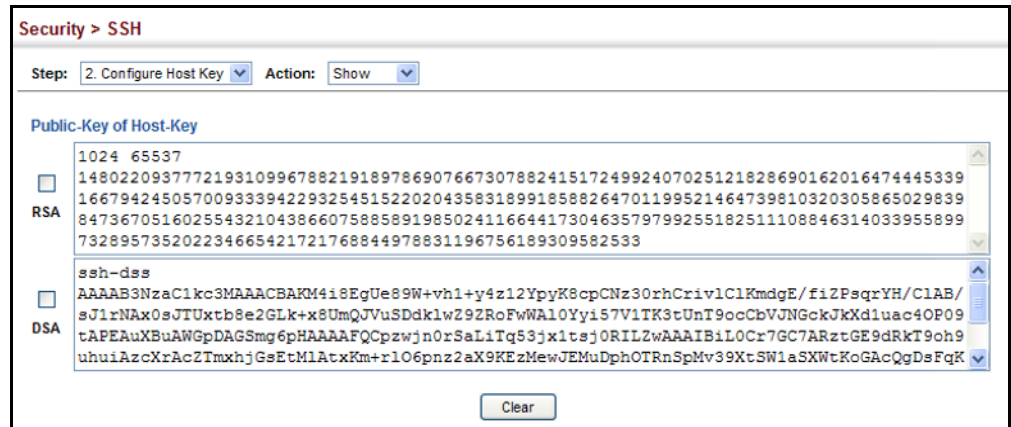

IMPORTING USER PUBLIC KEYS

Use the Security > SSH (Configure User Key - Copy) page to upload a user's public key to the switch. This public key must be stored on the switch for the user to be able to log in using the public key authentication mechanism. If the user's public key does not exist on the switch, SSH will revert to the interactive password authentication mechanism to complete authentication.

CLI REFERENCES

- ◆ "Secure Shell" on page 853

PARAMETERS

These parameters are displayed:

- ◆ **User Name** – This drop-down box selects the user who's public key you wish to manage. Note that you must first create users on the User Accounts page (see "Configuring User Accounts" on page 326).
- ◆ **User Key Type** – The type of public key to upload.
 - RSA: The switch accepts a RSA version 1 encrypted public key.
 - DSA: The switch accepts a DSA version 2 encrypted public key.

The SSH server uses RSA or DSA for key exchange when the client first establishes a connection with the switch, and then negotiates with the client to select either DES (56-bit) or 3DES (168-bit) for data encryption.

The switch uses only RSA Version 1 for SSHv1.5 clients and DSA Version 2 for SSHv2 clients.

- ◆ **TFTP Server IP Address** – The IP address of the TFTP server that contains the public key file you wish to import.
- ◆ **Source File Name** – The public key file to upload.

WEB INTERFACE

To copy the SSH user’s public key:

1. Click Security, SSH.
2. Select Configure User Key from the Step list.
3. Select Copy from the Action list.
4. Select the user name and the public-key type from the respective drop-down boxes, input the TFTP server IP address and the public key source file name.
5. Click Apply.

Figure 182: Copying the SSH User’s Public Key

The screenshot shows a web interface for configuring SSH settings. At the top, it says "Security > SSH". Below that, there are two dropdown menus: "Step:" set to "3. Configure User Key" and "Action:" set to "Copy". The main configuration area has four fields: "User Name" with a dropdown menu showing "steve", "User-Key Type" with a dropdown menu showing "RSA", "TFTP Server IP Address" with a text input field containing "192.168.0.61", and "Source File Name" with a text input field containing "rsa.pub". At the bottom right of the form are two buttons: "Apply" and "Revert".

To display or clear the SSH user’s public key:

1. Click Security, SSH.
2. Select Configure User Key from the Step list.
3. Select Show from the Action list.
4. Select a user from the User Name list.
5. Select the host-key type to clear.
6. Click Clear.

Figure 183: Showing the SSH User’s Public Key

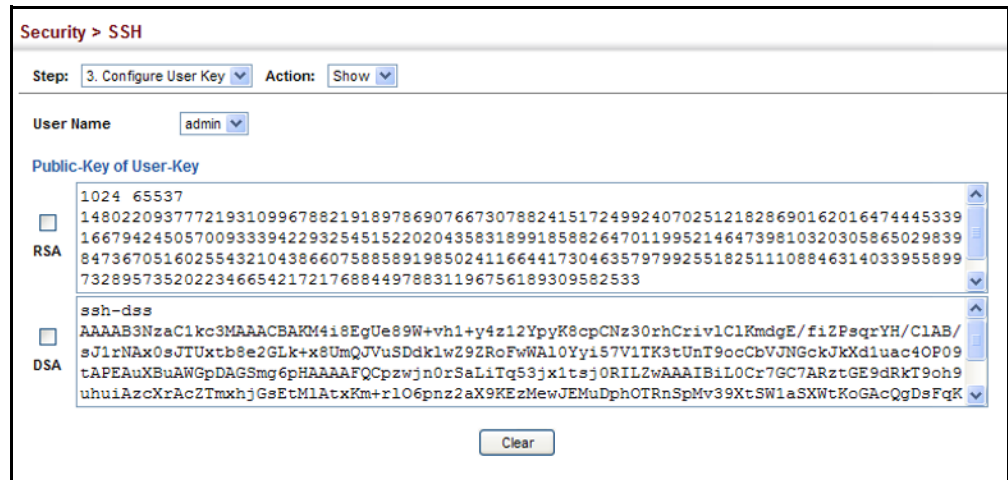

ACCESS CONTROL LISTS

Access Control Lists (ACL) provide packet filtering for IPv4/IPv6 frames (based on address, protocol, Layer 4 protocol port number or TCP control code), IPv6 frames (based on address, DSCP traffic class, or next header type), or any frames (based on MAC address or Ethernet type). To filter incoming packets, first create an access list, add the required rules, and then bind the list to a specific port.

Configuring Access Control Lists –

An ACL is a sequential list of permit or deny conditions that apply to IP addresses, MAC addresses, or other more specific criteria. This switch tests ingress packets against the conditions in an ACL one by one. A packet will be accepted as soon as it matches a permit rule, or dropped as soon as it matches a deny rule. If no rules match, the packet is accepted.

COMMAND USAGE

The following restrictions apply to ACLs:

- ◆ The maximum number of ACLs is 64.
- ◆ The maximum number of rules per system is 512 rules.
- ◆ An ACL can have up to 64 rules. However, due to resource restrictions, the average number of rules bound to the ports should not exceed 20.
- ◆ The maximum number of rules that can be bound to the ports is 64 for each of the following list types: MAC ACLs, IP ACLs (including Standard and Extended ACLs), IPv6 Standard ACLs, and IPv6 Extended ACLs.

The maximum number of rules (Access Control Entries, or ACEs) stated above is the worst case scenario. In practice, the switch compresses the ACEs in TCAM (a hardware table used to store ACEs), but the actual maximum number of ACEs possible depends on too many factors to be

precisely determined. It depends on the amount of hardware resources reserved at runtime for this purpose.

Auto ACE Compression is a software feature used to compress all the ACEs of an ACL to utilize hardware resources more efficiency. Without compression, one ACE would occupy a fixed number of entries in TCAM. So if one ACL includes 25 ACEs, the ACL would need $(25 * n)$ entries in TCAM, where "n" is the fixed number of TCAM entries needed for one ACE. When compression is employed, before writing the ACE into TCAM, the software compresses the ACEs to reduce the number of required TCAM entries. For example, one ACL may include 128 ACEs which classify a continuous IP address range like 192.168.1.0~255. If compression is disabled, the ACL would occupy $(128*n)$ entries of TCAM, using up nearly all of the hardware resources. When using compression, the 128 ACEs are compressed into one ACE classifying the IP address as 192.168.1.0/24, which requires only "n" entries in TCAM. The above example is an ideal case for compression. The worst case would be if no any ACE can be compressed, in which case the used number of TCAM entries would be the same as without compression. It would also require more time to process the ACEs.

The order in which active ACLs are checked is as follows:

1. User-defined rules in IP and MAC ACLs for ingress or egress ports are checked in parallel.
2. Rules within an ACL are checked in the configured order, from top to bottom.
3. If the result of checking an IP ACL is to permit a packet, but the result of a MAC ACL on the same packet is to deny it, the packet will be denied (because the decision to deny a packet has a higher priority for security reasons). A packet will also be denied if the IP ACL denies it and the MAC ACL accepts it.

SETTING A TIME RANGE Use the Security > ACL (Configure Time Range) page to sets a time range during which ACL functions are applied.

CLI REFERENCES

- ◆ ["Time Range" on page 782](#)

COMMAND USAGE

If both an absolute rule and one or more periodic rules are configured for the same time range (i.e., named entry), that entry will only take effect if the current time is within the absolute time range and one of the periodic time ranges.

PARAMETERS

These parameters are displayed:

Add

- ◆ **Time-Range Name** – Name of a time range. (Range: 1-16 characters)

Add Rule

- ◆ **Time-Range** – Name of a time range.
- ◆ **Mode**
 - **Absolute** – Specifies a specific time or time range.
 - **Start/End** – Specifies the hours, minutes, month, day, and year at which to start or end.
 - **Periodic** – Specifies a periodic interval.
 - **Start/To** – Specifies the days of the week, hours, and minutes at which to start or end.

WEB INTERFACE

To configure a time range:

1. Click Security, ACL.
2. Select Configure Time Range from the Step list.
3. Select Add from the Action list.
4. Enter the name of a time range.
5. Click Apply.

Figure 184: Setting the Name of a Time Range

The screenshot shows a web interface for configuring a time range. At the top, it says "Security > ACL". Below that, there are two dropdown menus: "Step:" with "1. Configure Time-Range" selected, and "Action:" with "Add" selected. Below these is a text input field labeled "Time-Range Name" containing the text "R&D". At the bottom right, there are two buttons: "Apply" and "Revert".

To show a list of time ranges:

1. Click Security, ACL.
2. Select Configure Time Range from the Step list.
3. Select Show from the Action list.

Figure 185: Showing a List of Time Ranges

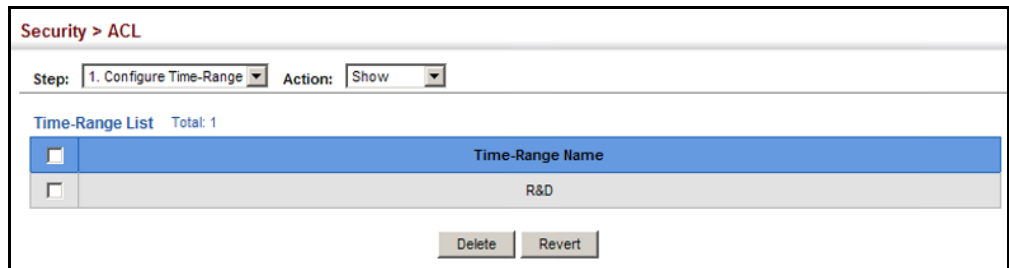

To configure a rule for a time range:

1. Click Security, ACL.
2. Select Configure Time Range from the Step list.
3. Select Add Rule from the Action list.
4. Select the name of time range from the drop-down list.
5. Select a mode option of Absolute or Periodic.
6. Fill in the required parameters for the selected mode.
7. Click Apply.

Figure 186: Add a Rule to a Time Range

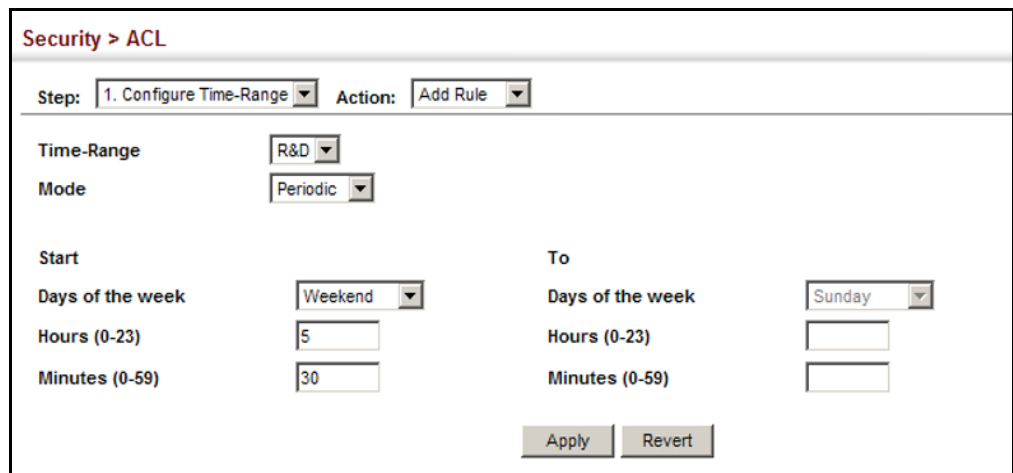

To show the rules configured for a time range:

1. Click Security, ACL.
2. Select Configure Time Range from the Step list.
3. Select Show Rule from the Action list.

Figure 187: Showing the Rules Configured for a Time Range

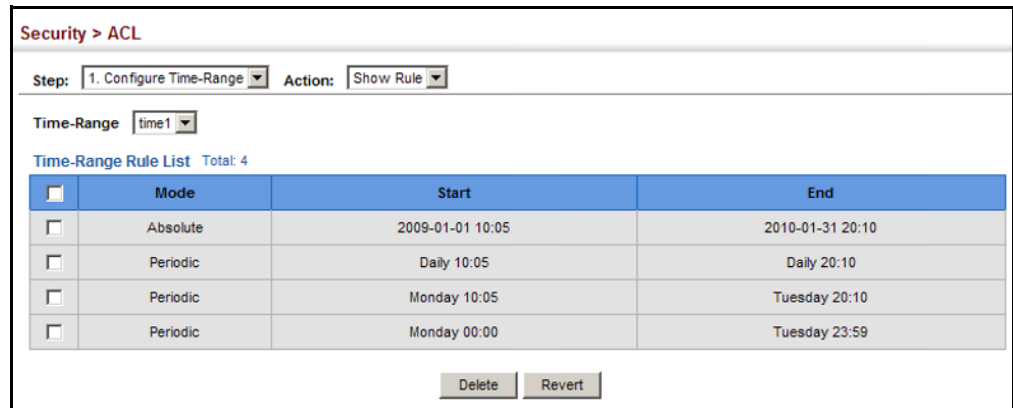

SHOWING TCAM UTILIZATION

Use the Security > ACL (Configure ACL - Show TCAM) page to show utilization parameters for TCAM (Ternary Content Addressable Memory), including the number policy control entries in use, the number of free entries, and the overall percentage of TCAM in use.

CLI REFERENCES

- ◆ "show access-list tcam-utilization" on page 728

COMMAND USAGE

Policy control entries (PCEs) are used by various system functions which rely on rule-based searches, including Access Control Lists (ACLs), IP Source Guard filter rules, Quality of Service (QoS) processes, QinQ, MAC-based VLANs, VLAN translation, or traps.

For example, when binding an ACL to a port, each rule in an ACL will use two PCEs; and when setting an IP Source Guard filter rule for a port, the system will also use two PCEs.

PARAMETERS

These parameters are displayed:

- ◆ **Total Policy Control Entries** – The number policy control entries in use.
- ◆ **Free Policy Control Entries** – The number of policy control entries available for use.
- ◆ **Entries Used by System** – The number of policy control entries used by the operating system.
- ◆ **Entries Used by User** – The number of policy control entries used by configuration settings, such as access control lists.
- ◆ **TCAM Utilization** – The overall percentage of TCAM in use.

WEB INTERFACE

To show information on TCAM utilization:

1. Click Security, ACL.
2. Select Configure ACL from the Step list.
3. Select Show TCAM from the Action list.

Figure 188: Showing TCAM Utilization

Security > ACL	
Step:	2. Configure ACL
Action:	Show TCAM
Total Policy Control Entries	512
Free Policy Control Entries	330
Entries Used by System	182
Entries Used by User	0
TCAM Utilization	35.54

SETTING THE ACL NAME AND TYPE Use the Security > ACL (Configure ACL - Add) page to create an ACL.

CLI REFERENCES

- ◆ "access-list ip" on page 970
- ◆ "show ip access-list" on page 976
- ◆ "access-list ipv6" on page 977
- ◆ "show ipv6 access-list" on page 982

PARAMETERS

These parameters are displayed:

- ◆ **ACL Name** – Name of the ACL. (Maximum length: 32 characters)
- ◆ **Type** – The following filter modes are supported:
 - **IP Standard:** IPv4 ACL mode filters packets based on the source IPv4 address.
 - **IP Extended:** IPv4 ACL mode filters packets based on the source or destination IPv4 address, as well as the protocol type and protocol port number. If the "TCP" protocol is specified, then you can also filter packets based on the TCP control code.
 - **IPv6 Standard:** IPv6 ACL mode filters packets based on the source IPv6 address.
 - **IPv6 Extended:** IPv6 ACL mode filters packets based on the source or destination IP address, as well as DSCP, and the next header type.

- **MAC** – MAC ACL mode filters packets based on the source or destination MAC address and the Ethernet frame type (RFC 1060).
- **ARP** – ARP ACL specifies static IP-to-MAC address bindings used for ARP inspection (see "[ARP Inspection](#)" on page 375).

WEB INTERFACE

To configure the name and type of an ACL:

1. Click Security, ACL.
2. Select Configure ACL from the Step list.
3. Select Add from the Action list.
4. Fill in the ACL Name field, and select the ACL type.
5. Click Apply.

Figure 189: Creating an ACL

Security > ACL

Step: 2. Configure ACL Action: Add

ACL Name R&D

Type IP Standard

Apply Revert

To show a list of ACLs:

1. Click Security, ACL.
2. Select Configure ACL from the Step list.
3. Select Show from the Action list.

Figure 190: Showing a List of ACLs

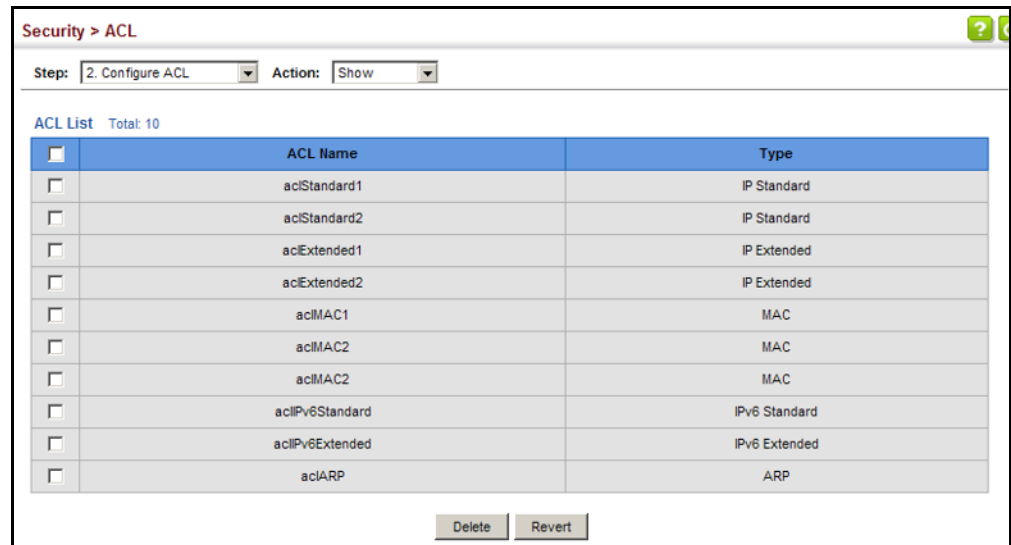

CONFIGURING A STANDARD IPV4 ACL Use the Security > ACL (Configure ACL - Add Rule - IP Standard) page to configure a Standard IPv4 ACL.

CLI REFERENCES

- ◆ "permit, deny (Standard IP ACL)" on page 971
- ◆ "show ip access-list" on page 976
- ◆ "Time Range" on page 782

PARAMETERS

These parameters are displayed:

- ◆ **Type** – Selects the type of ACLs to show in the Name list.
- ◆ **Name** – Shows the names of ACLs matching the selected type.
- ◆ **Action** – An ACL can contain any combination of rules which permit or deny a packet.
- ◆ **Address Type** – Specifies the source IP address. Use "Any" to include all possible addresses, "Host" to specify a specific host address in the Address field, or "IP" to specify a range of addresses with the Address and Subnet Mask fields. (Options: Any, Host, IP; Default: Any)
- ◆ **Source IP Address** – Source IP address.
- ◆ **Source Subnet Mask** – A subnet mask containing four integers from 0 to 255, each separated by a period. The mask uses 1 bits to indicate "match" and 0 bits to indicate "ignore." The mask is bitwise ANDed with the specified source IP address, and compared with the address for each IP packet entering the port(s) to which this ACL has been assigned.
- ◆ **Time Range** – Name of a time range.

WEB INTERFACE

To add rules to an IPv4 Standard ACL:

1. Click Security, ACL.
2. Select Configure ACL from the Step list.
3. Select Add Rule from the Action list.
4. Select IP Standard from the Type list.
5. Select the name of an ACL from the Name list.
6. Specify the action (i.e., Permit or Deny).
7. Select the address type (Any, Host, or IP).
8. If you select "Host," enter a specific address. If you select "IP," enter a subnet address and the mask for an address range.
9. Click Apply.

Figure 191: Configuring a Standard IPv4 ACL

The screenshot shows the 'Security > ACL' configuration page. At the top, the breadcrumb is 'Security > ACL'. Below it, the 'Step' is set to '2. Configure ACL' and the 'Action' is 'Add Rule'. The 'Type' section has radio buttons for 'IP Standard' (selected), 'IP Extended', 'MAC', 'IPv6 Standard', 'IPv6 Extended', and 'ARP'. The 'Name' field is 'R&D'. The 'Action' dropdown is set to 'Permit'. The 'Address Type' dropdown is set to 'Host'. The 'Source IP Address' field contains '10.1.1.21' and the 'Source Subnet Mask' field contains '255.255.255.255'. The 'Time-Range' checkbox is checked, and its dropdown is set to 'R&D'. At the bottom right, there are 'Apply' and 'Revert' buttons.

CONFIGURING AN EXTENDED IPv4 ACL

Use the Security > ACL (Configure ACL - Add Rule - IP Extended) page to configure an Extended IPv4 ACL.

CLI REFERENCES

- ◆ "permit, deny (Extended IPv4 ACL)" on page 972
- ◆ "show ip access-list" on page 976
- ◆ "Time Range" on page 782

COMMAND USAGE

Due to a ASIC limitation, the switch only checks the leftmost six priority bits. This presents no problem when checking DSCP or IP Precedence bits,

but limits the checking of ToS bits (underlined in the following example) to the leftmost three bits, ignoring the right most fourth bit.

For example, if you configured an access list to deny packets with a ToS of 7 (00001110), the highlighted bit would be ignored, and the access list would drop packets with a ToS of both 6 and 7.

Table 21: Priority Bits Processed by Extended IPv4 ACL

DSCP								
Precedence			ToS					
7	6	5	4	3	2	1	0	

PARAMETERS

These parameters are displayed:

- ◆ **Type** – Selects the type of ACLs to show in the Name list.
- ◆ **Name** – Shows the names of ACLs matching the selected type.
- ◆ **Action** – An ACL can contain any combination of rules which permit or deny a packet.
- ◆ **Source/Destination Address Type** – Specifies the source or destination IP address type. Use “Any” to include all possible addresses, “Host” to specify a specific host address in the Address field, or “IP” to specify a range of addresses with the Address and Subnet Mask fields. (Options: Any, Host, IP; Default: Any)
- ◆ **Source/Destination IP Address** – Source or destination IP address.
- ◆ **Source/Destination Subnet Mask** – Subnet mask for source or destination address. (See the description for Subnet Mask on [page 359](#).)
- ◆ **Source/Destination Port** – Source/destination port number for the specified protocol type. (Range: 0-65535)
- ◆ **Source/Destination Port Bit Mask** – Decimal number representing the port bits to match. (Range: 0-65535)
- ◆ **Protocol** – Specifies the protocol type to match as TCP, UDP or Others, where others indicates a specific protocol number (0-255). (Options: TCP, UDP, Others; Default: Others)
- ◆ **Service Type** – Packet priority settings based on the following criteria:
 - **Precedence** – IP precedence level. (Range: 0-7)
 - **DSCP** – DSCP priority level. (Range: 0-63)
- ◆ **Control Code** – Decimal number (representing a bit string) that specifies flag bits in byte 14 of the TCP header. (Range: 0-63)

- ◆ **Control Code Bit Mask** – Decimal number representing the code bits to match. (Range: 0-63)

The control bit mask is a decimal number (for an equivalent binary bit mask) that is applied to the control code. Enter a decimal number, where the equivalent binary bit "1" means to match a bit and "0" means to ignore a bit. The following bits may be specified:

- 1 (fin) – Finish
- 2 (syn) – Synchronize
- 4 (rst) – Reset
- 8 (psh) – Push
- 16 (ack) – Acknowledgement
- 32 (urg) – Urgent pointer

For example, use the code value and mask below to catch packets with the following flags set:

- SYN flag valid, use control-code 2, control bit mask 2
- Both SYN and ACK valid, use control-code 18, control bit mask 18
- SYN valid and ACK invalid, use control-code 2, control bit mask 18

- ◆ **Time Range** – Name of a time range.

WEB INTERFACE

To add rules to an IPv4 Extended ACL:

1. Click Security, ACL.
2. Select Configure ACL from the Step list.
3. Select Add Rule from the Action list.
4. Select IP Extended from the Type list.
5. Select the name of an ACL from the Name list.
6. Specify the action (i.e., Permit or Deny).
7. Select the address type (Any, Host, or IP).
8. If you select "Host," enter a specific address. If you select "IP," enter a subnet address and the mask for an address range.
9. Set any other required criteria, such as service type, protocol type, or control code.
10. Click Apply.

Figure 192: Configuring an Extended IPv4 ACL

The screenshot shows the 'Security > ACL' configuration page. At the top, the 'Step' is '2. Configure ACL' and the 'Action' is 'Add Rule'. The 'Type' is set to 'IP Extended'. The 'Name' is 'R&D#2'. The 'Action' is 'Permit'. The 'Source Address Type' is 'IP' with 'Source IP Address' '10.7.1.0' and 'Source Subnet Mask' '255.255.255.0'. The 'Destination Address Type' is 'Any' with 'Destination IP Address' '0.0.0.0' and 'Destination Subnet Mask' '0.0.0.0'. The 'Protocol' is 'TCP (6)'. The 'Service Type' is 'Precedence (0-7)'. There are 'Apply' and 'Revert' buttons at the bottom right.

CONFIGURING A STANDARD IPV6 ACL Use the Security > ACL (Configure ACL - Add Rule - IPv6 Standard) page to configure a Standard IPv6ACL.

CLI REFERENCES

- ◆ "permit, deny (Standard IPv6 ACL)" on page 978
- ◆ "show ipv6 access-list" on page 982
- ◆ "Time Range" on page 782

PARAMETERS

These parameters are displayed:

- ◆ **Type** – Selects the type of ACLs to show in the Name list.
- ◆ **Name** – Shows the names of ACLs matching the selected type.
- ◆ **Action** – An ACL can contain any combination of rules which permit or deny a packet.
- ◆ **Source Address Type** – Specifies the source IP address. Use "Any" to include all possible addresses, "Host" to specify a specific host address in the Address field, or "IPv6-Prefix" to specify a range of addresses. (Options: Any, Host, IPv6-Prefix; Default: Any)
- ◆ **Source IPv6 Address** – An IPv6 source address or network class. The address must be formatted according to RFC 2373 "IPv6 Addressing Architecture," using 8 colon-separated 16-bit hexadecimal values. One double colon may be used in the address to indicate the appropriate number of zeros required to fill the undefined fields.

- ◆ **Source Prefix-Length** – A decimal value indicating how many contiguous bits (from the left) of the address comprise the prefix (i.e., the network portion of the address). (Range: 0-128 bits)
- ◆ **Time Range** – Name of a time range.

WEB INTERFACE

To add rules to a Standard IPv6 ACL:

1. Click Security, ACL.
2. Select Configure ACL from the Step list.
3. Select Add Rule from the Action list.
4. Select IPv6 Standard from the Type list.
5. Select the name of an ACL from the Name list.
6. Specify the action (i.e., Permit or Deny).
7. Select the source address type (Any, Host, or IPv6-prefix).
8. If you select "Host," enter a specific address. If you select "IPv6-prefix," enter a subnet address and the prefix length.
9. Click Apply.

Figure 193: Configuring a Standard IPv6 ACL

The screenshot shows the 'Security > ACL' configuration page. At the top, the breadcrumb 'Security > ACL' is visible. Below it, the 'Step' is set to '2. Configure ACL' and the 'Action' is 'Add Rule'. The 'Type' section has radio buttons for 'IP Standard', 'IP Extended', 'MAC', 'IPv6 Standard' (which is selected), 'IPv6 Extended', and 'ARP'. The 'Name' field is a dropdown menu showing 'R&D#6S'. The 'Action' dropdown is set to 'Permit'. The 'Source Address Type' dropdown is set to 'Host'. The 'Source IPv6 Address' text box contains '2009:DB9:2229::79'. The 'Source Prefix Length (0-128)' text box contains '128'. There is a checkbox for 'Time-Range' which is unchecked, and a dropdown menu next to it showing 'R&D'. At the bottom right, there are 'Apply' and 'Revert' buttons.

CONFIGURING AN EXTENDED IPv6 ACL Use the Security > ACL (Configure ACL - Add Rule - IPv6 Extended) page to configure an Extended IPv6 ACL.

CLI REFERENCES

- ◆ "permit, deny (Extended IPv6 ACL)" on page 979
- ◆ "show ipv6 access-list" on page 982
- ◆ "Time Range" on page 782

PARAMETERS

These parameters are displayed:

- ◆ **Type** – Selects the type of ACLs to show in the Name list.
- ◆ **Name** – Shows the names of ACLs matching the selected type.
- ◆ **Action** – An ACL can contain any combination of rules which permit or deny a packet.
- ◆ **Source Address Type** – Specifies the source IP address type. Use "Any" to include all possible addresses, "Host" to specify a specific host address in the Address field, or "IPv6-Prefix" to specify a range of addresses. (Options: Any, Host, IPv6-Prefix; Default: Any)
- ◆ **Destination Address Type** – Specifies the destination IP address type. Use "Any" to include all possible addresses, or "IPv6-Prefix" to specify a range of addresses. (Options: Any, IPv6-Prefix; Default: Any)
- ◆ **Source/Destination IPv6 Address** – An IPv6 address or network class. The address must be formatted according to RFC 2373 "IPv6 Addressing Architecture," using 8 colon-separated 16-bit hexadecimal values. One double colon may be used in the address to indicate the appropriate number of zeros required to fill the undefined fields. (The switch only checks the first 64 bits of the destination address.)
- ◆ **Source/Destination Prefix-Length** – A decimal value indicating how many contiguous bits (from the left) of the address comprise the prefix; i.e., the network portion of the address. (Range: 0-128 bits for the source prefix, 0-8 bits for the destination prefix)
- ◆ **DSCP** – DSCP traffic class. (Range: 0-63)
- ◆ **Next Header** – Identifies the type of header immediately following the IPv6 header. (Range: 0-255)

Optional internet-layer information is encoded in separate headers that may be placed between the IPv6 header and the upper-layer header in a packet. There are a small number of such extension headers, each identified by a distinct Next Header value. IPv6 supports the values defined for the IPv4 Protocol field in RFC 1700, and includes these commonly used headers:

- 0: Hop-by-Hop Options (RFC 2460)
- 6: TCP Upper-layer Header (RFC 1700)
- 17: UDP Upper-layer Header (RFC 1700)

- 43: Routing (RFC 2460)
- 44: Fragment (RFC 2460)
- 50: Encapsulating Security Payload (RFC 2406)
- 51: Authentication (RFC 2402)
- 60: Destination Options (RFC 2460)

◆ **Time Range** – Name of a time range.

WEB INTERFACE

To add rules to an Extended IPv6 ACL:

1. Click Security, ACL.
2. Select Configure ACL from the Step list.
3. Select Add Rule from the Action list.
4. Select IPv6 Extended from the Type list.
5. Select the name of an ACL from the Name list.
6. Specify the action (i.e., Permit or Deny).
7. Select the address type (Any or IPv6-prefix).
8. If you select "Host," enter a specific address. If you select "IPv6-prefix," enter a subnet address and prefix length.
9. Set any other required criteria, such as DSCP or next header type.
10. Click Apply.

Figure 194: Configuring an Extended IPv6 ACL

The screenshot shows the configuration page for an IPv6 ACL. The breadcrumb is "Security > ACL". The "Step" is "2. Configure ACL" and the "Action" is "Add Rule".

Type: Radio buttons for IP Standard, IP Extended, MAC, IPv6 Standard, IPv6 Extended (selected), and ARP.

Name: A dropdown menu showing "ipv6e".

Action: A dropdown menu showing "Permit".

Source Address Type: A dropdown menu showing "IPv6-Prefix".

Source IPv6 Address: A text input field containing "2009:DB9:2229:79".

Source Prefix Length (0-128): A text input field containing "8".

Destination Address Type: A dropdown menu showing "Any".

Destination IPv6 Address: A text input field containing "::".

Destination Prefix Length (0-8): A text input field containing "0".

DSCP (0-63): A text input field.

Next-Header (0-255): A text input field.

Time-Range: A checkbox labeled "Time-Range" is unchecked, and a dropdown menu shows "R&D".

Buttons for "Apply" and "Revert" are at the bottom right.

CONFIGURING A MAC ACL Use the Security > ACL (Configure ACL - Add Rule - MAC) page to configure a MAC ACL based on hardware addresses, packet format, and Ethernet type.

CLI REFERENCES

- ◆ "permit, deny (MAC ACL)" on page 984
- ◆ "show ip access-list" on page 976
- ◆ "Time Range" on page 782

PARAMETERS

These parameters are displayed:

- ◆ **Type** – Selects the type of ACLs to show in the Name list.
- ◆ **Name** – Shows the names of ACLs matching the selected type.
- ◆ **Action** – An ACL can contain any combination of rules which permit or deny a packet.
- ◆ **Source/Destination Address Type** – Use "Any" to include all possible addresses, "Host" to indicate a specific MAC address, or "MAC" to specify an address range with the Address and Bit Mask fields. (Options: Any, Host, MAC; Default: Any)
- ◆ **Source/Destination MAC Address** – Source or destination MAC address.
- ◆ **Source/Destination Bit Mask** – Hexadecimal mask for source or destination MAC address.
- ◆ **Packet Format** – This attribute includes the following packet types:
 - **Any** – Any Ethernet packet type.
 - **Untagged-eth2** – Untagged Ethernet II packets.
 - **Untagged-802.3** – Untagged Ethernet 802.3 packets.
 - **Tagged-eth2** – Tagged Ethernet II packets.
 - **Tagged-802.3** – Tagged Ethernet 802.3 packets.
- ◆ **VID** – VLAN ID. (Range: 1-4094)
- ◆ **VID Bit Mask** – VLAN bit mask. (Range: 0-4095)
- ◆ **Ethernet Type** – This option can only be used to filter Ethernet II formatted packets. (Range: 0-ffff hex.)

A detailed listing of Ethernet protocol types can be found in RFC 1060. A few of the more common types include 0800 (IP), 0806 (ARP), 8137 (IPX).
- ◆ **Ethernet Type Bit Mask** – Protocol bit mask. (Range: 0-ffff hex.)

- ◆ **Internet Protocol** – Layer 3 or 4 information to match.
 - **No** – Not applied.
 - **IPv4** – See ["Configuring an Extended IPv4 ACL" on page 360.](#)
 - **IPv6** – See ["Configuring an Extended IPv6 ACL" on page 365.](#)
- ◆ **Time Range** – Name of a time range.

WEB INTERFACE

To add rules to a MAC ACL:

1. Click Security, ACL.
2. Select Configure ACL from the Step list.
3. Select Add Rule from the Action list.
4. Select MAC from the Type list.
5. Select the name of an ACL from the Name list.
6. Specify the action (i.e., Permit or Deny).
7. Select the address type (Any, Host, or MAC).
8. If you select "Host," enter a specific address (e.g., 11-22-33-44-55-66). If you select "MAC," enter a base address and a hexadecimal bit mask for an address range.
9. Set any other required criteria, such as VID, Ethernet type, or packet format.
10. Click Apply.

Figure 195: Configuring a MAC ACL

The screenshot shows the 'Security > ACL' configuration page. At the top, it indicates 'Step: 2. Configure ACL' and 'Action: Add Rule'. The 'Type' is set to 'MAC'. The 'Name' is 'mac'. The 'Action' is 'Permit'. The 'Source Address Type' is 'Any', 'Source MAC Address' is '00-00-00-00-00-00', and 'Source Bit Mask' is '00-00-00-00-00-00'. The 'Destination Address Type' is 'Any', 'Destination MAC Address' is '00-00-00-00-00-00', and 'Destination Bit Mask' is '00-00-00-00-00-00'. The 'Packet Format' is 'Any'. There are fields for 'VID (1-4094)', 'VID Bit Mask (0-4095)', 'Ethernet Type', and 'Ethernet Type Bit Mask'. The 'Internet Protocol' is set to 'No'. There is a 'Time-Range' checkbox and a dropdown menu. 'Apply' and 'Revert' buttons are at the bottom right.

CONFIGURING AN ARP ACL Use the Security > ACL (Configure ACL - Add Rule - ARP) page to configure ACLs based on ARP message addresses. ARP Inspection can then use these ACLs to filter suspicious traffic (see "[Configuring Global Settings for ARP Inspection](#)" on page 376).

CLI REFERENCES

- ◆ "permit, deny (ARP ACL)" on page 990
- ◆ "show ip access-list" on page 976
- ◆ "Time Range" on page 782

PARAMETERS

These parameters are displayed:

- ◆ **Type** – Selects the type of ACLs to show in the Name list.
- ◆ **Name** – Shows the names of ACLs matching the selected type.
- ◆ **Action** – An ACL can contain any combination of permit or deny rules.
- ◆ **Packet Type** – Indicates an ARP request, ARP response, or either type. (Range: IP, Request, Response; Default: IP)
- ◆ **Source/Destination IP Address Type** – Specifies the source or destination IPv4 address. Use "Any" to include all possible addresses, "Host" to specify a specific host address in the Address field, or "IP" to specify a range of addresses with the Address and Mask fields. (Options: Any, Host, IP; Default: Any)
- ◆ **Source/Destination IP Address** – Source or destination IP address.

- ◆ **Source/Destination IP Subnet Mask** – Subnet mask for source or destination address. (See the description for Subnet Mask on [page 359](#).)
- ◆ **Source/Destination MAC Address Type** – Use “Any” to include all possible addresses, “Host” to indicate a specific MAC address, or “MAC” to specify an address range with the Address and Mask fields. (Options: Any, Host, MAC; Default: Any)
- ◆ **Source/Destination MAC Address** – Source or destination MAC address.
- ◆ **Source/Destination MAC Bit Mask** – Hexadecimal mask for source or destination MAC address.
- ◆ **Log** – Logs a packet when it matches the access control entry.

WEB INTERFACE

To add rules to an ARP ACL:

1. Click Security, ACL.
2. Select Configure ACL from the Step list.
3. Select Add Rule from the Action list.
4. Select ARP from the Type list.
5. Select the name of an ACL from the Name list.
6. Specify the action (i.e., Permit or Deny).
7. Select the packet type (Request, Response, All).
8. Select the address type (Any, Host, or IP).
9. If you select “Host,” enter a specific address (e.g., 11-22-33-44-55-66). If you select “IP,” enter a base address and a hexadecimal bit mask for an address range.
10. Enable logging if required.
11. Click Apply.

Figure 196: Configuring a ARP ACL

The screenshot shows the 'Security > ACL' configuration page. At the top, 'Step: 2. Configure ACL' and 'Action: Add Rule' are displayed. The 'Type' section has radio buttons for IP Standard, IP Extended, MAC, IPv6 Standard, IPv6 Extended, and ARP (which is selected). The 'Name' field contains 'R&D#7ARP'. The 'Action' is set to 'Permit'. The 'Packet Type' is set to 'IP'. The 'Source IP Address Type' is 'Any', and the 'Destination IP Address Type' is 'Any'. Both source and destination IP addresses and subnet masks are set to '0.0.0.0'. The 'Source MAC Address Type' is 'Any', and the 'Destination MAC Address Type' is 'Any'. Both source and destination MAC addresses and bit masks are set to '00-00-00-00-00-00'. There is a 'Log' checkbox which is unchecked. 'Apply' and 'Revert' buttons are at the bottom right.

BINDING A PORT TO AN ACCESS CONTROL LIST

After configuring ACLs, use the Security > ACL (Configure Interface – Configure) page to bind the ports that need to filter traffic to the appropriate ACLs. Only one access list (IPv4, IPv6 or MAC) can be assigned to a port.

CLI REFERENCES

- ◆ "ip access-group" on page 975
- ◆ "show ip access-group" on page 975
- ◆ "mac access-group" on page 987
- ◆ "show mac access-group" on page 988
- ◆ "Time Range" on page 782

COMMAND USAGE

- ◆ This switch supports ACLs for ingress filtering only.
- ◆ You only bind one ACL to any port for ingress filtering.

PARAMETERS

These parameters are displayed:

- ◆ **Type** – Selects the type of ACLs to bind to a port.
- ◆ **Port** – Port identifier.
- ◆ **ACL** – ACL used for ingress packets.
- ◆ **Time Range** – Name of a time range.
- ◆ **Counter** – Enables counter for ACL statistics.

WEB INTERFACE

To bind an ACL to a port:

1. Click Security, ACL.
2. Select Configure Interface from the Step list.
3. Select Configure from the Action list.
4. Select IP, MAC or IPv6 from the Type options.
5. Select a port.
6. Select the name of an ACL from the ACL list.
7. Click Apply.

Figure 197: Binding a Port to an ACL

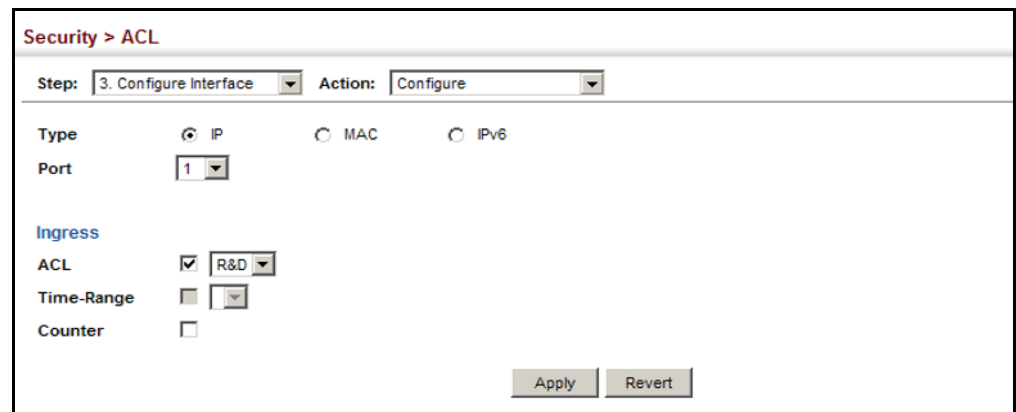

CONFIGURING ACL MIRRORING

After configuring ACLs, use the Security > ACL (Configure Interface – Add Mirror) page to mirror traffic matching an ACL from one or more source ports to a target port for real-time analysis. You can then attach a logic analyzer or RMON probe to the target port and study the traffic crossing the source VLAN(s) in a completely unobtrusive manner.

CLI REFERENCES

- ◆ ["Local Port Mirroring Commands" on page 1045](#)

COMMAND USAGE

ACL-based mirroring is only used for ingress traffic. To mirror an ACL, follow these steps:

1. Create an ACL as described in the preceding sections.
2. Add one or more mirrored ports to ACL as described under ["Binding a Port to an Access Control List" on page 371](#).

3. Use the Add Mirror page to specify the ACL and the destination port to which matching traffic will be mirrored.

PARAMETERS

These parameters are displayed:

- ◆ **Port** – Port identifier.
- ◆ **ACL** – ACL used for ingress packets.

WEB INTERFACE

To bind an ACL to a port:

1. Click Security, ACL.
2. Select Configure Interface from the Step list.
3. Select Add Mirror from the Action list.
4. Select a port.
5. Select the name of an ACL from the ACL list.
6. Click Apply.

Figure 198: Configuring ACL Mirroring

The screenshot shows a web interface for configuring ACL mirroring. At the top, it says "Security > ACL". Below that, there are two dropdown menus: "Step:" with "3. Configure Interface" selected, and "Action:" with "Add Mirror" selected. Underneath, there are two more dropdown menus: "Port" with "1" selected, and "ACL" with "ips" selected. At the bottom right, there are two buttons: "Apply" and "Revert".

To show the ACLs to be mirrored:

1. Select Configure Interface from the Step list.
2. Select Show Mirror from the Action list.
3. Select a port.

Figure 199: Showing the VLANs to Mirror

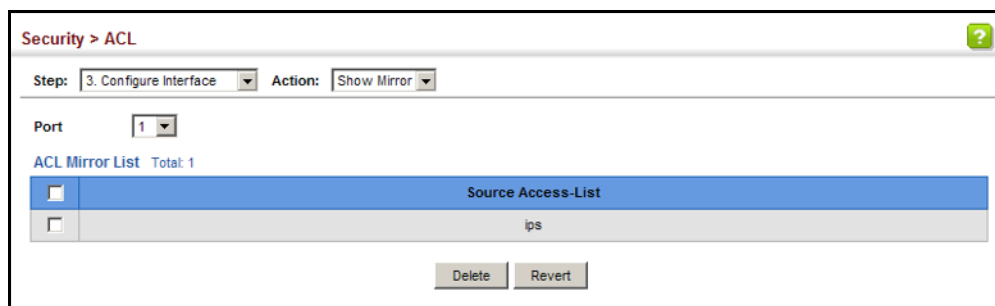

SHOWING ACL HARDWARE COUNTERS

Use the Security > ACL > Configure Interface (Show Hardware Counters) page to show statistics for ACL hardware counters.

CLI REFERENCES

- ◆ "show access-list" on page 993
- ◆ "clear access-list hardware counters" on page 992

PARAMETERS

These parameters are displayed:

- ◆ **Port** – Port identifier. (Range: 1-28/52)
- ◆ **Type** – Selects the type of ACL.
- ◆ **Direction** – Displays statistics for ingress.
- ◆ **ACL Name** – The ACL bound this port.
- ◆ **Action** – Shows if action is to permit or deny specified packets.
- ◆ **Rules** – Shows the rules for the ACL bound to this port.
- ◆ **Time-Range** – Name of a time range.
- ◆ **Hits** – Shows the number of packets matching this ACL.⁷
- ◆ **Clear Counter** – Clears the hit counter for the specified ACL.

WEB INTERFACE

To show statistics for ACL hardware counters:

1. Click Security, ACL.
2. Select Configure Interface from the Step list.
3. Select Show Hardware Counters from the Action list.
4. Select a port.

7. Due to a hardware limitation, statistics are only displayed for permit rules.

5. Select ingress or egress traffic.

Figure 200: Showing ACL Statistics

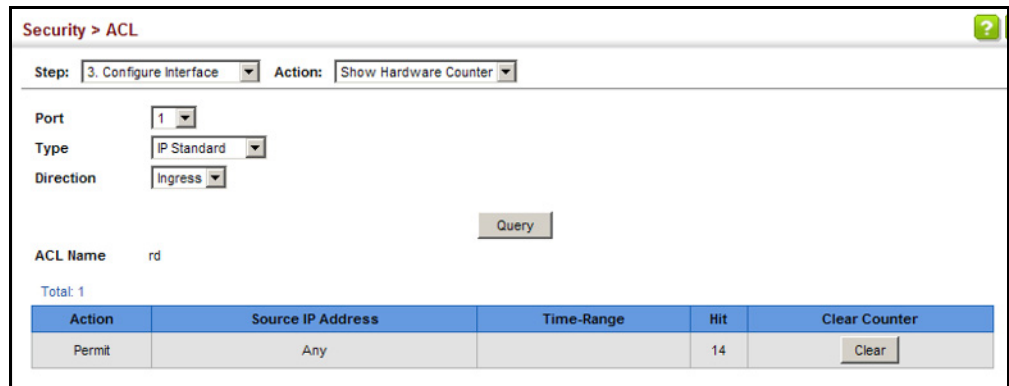

ARP INSPECTION

ARP Inspection is a security feature that validates the MAC Address bindings for Address Resolution Protocol packets. It provides protection against ARP traffic with invalid MAC-to-IP address bindings, which forms the basis for certain “man-in-the-middle” attacks. This is accomplished by intercepting all ARP requests and responses and verifying each of these packets before the local ARP cache is updated or the packet is forwarded to the appropriate destination. Invalid ARP packets are dropped.

ARP Inspection determines the validity of an ARP packet based on valid IP-to-MAC address bindings stored in a trusted database – the DHCP snooping binding database (see ["DHCP Snooping Global Configuration" on page 415](#)). This database is built by DHCP snooping if it is enabled on globally on the switch and on the required VLANs. ARP Inspection can also validate ARP packets against user-configured ARP access control lists (ACLs) for hosts with statically configured addresses (see ["Configuring an ARP ACL" on page 369](#)).

COMMAND USAGE

Enabling & Disabling ARP Inspection

- ◆ ARP Inspection is controlled on a global and VLAN basis.
- ◆ By default, ARP Inspection is disabled both globally and on all VLANs.
 - If ARP Inspection is globally enabled, then it becomes active only on the VLANs where it has been enabled.
 - When ARP Inspection is enabled globally, all ARP request and reply packets on inspection-enabled VLANs are redirected to the CPU and their switching behavior handled by the ARP Inspection engine.
 - If ARP Inspection is disabled globally, then it becomes inactive for all VLANs, including those where inspection is enabled.

- When ARP Inspection is disabled, all ARP request and reply packets will bypass the ARP Inspection engine and their switching behavior will match that of all other packets.
 - Disabling and then re-enabling global ARP Inspection will not affect the ARP Inspection configuration of any VLANs.
 - When ARP Inspection is disabled globally, it is still possible to configure ARP Inspection for individual VLANs. These configuration changes will only become active after ARP Inspection is enabled globally again.
- ◆ The ARP Inspection engine in the current firmware version does not support ARP Inspection on trunk ports.

CONFIGURING GLOBAL SETTINGS FOR ARP INSPECTION

Use the Security > ARP Inspection (Configure General) page to enable ARP inspection globally for the switch, to validate address information in each packet, and configure logging.

CLI REFERENCES

- ◆ ["ARP Inspection" on page 948](#)

COMMAND USAGE

ARP Inspection Validation

- ◆ By default, ARP Inspection Validation is disabled.
- ◆ Specifying at least one of the following validations enables ARP Inspection Validation globally. Any combination of the following checks can be active concurrently.
 - Destination MAC – Checks the destination MAC address in the Ethernet header against the target MAC address in the ARP body. This check is performed for ARP responses. When enabled, packets with different MAC addresses are classified as invalid and are dropped.
 - IP – Checks the ARP body for invalid and unexpected IP addresses. These addresses include 0.0.0.0, 255.255.255.255, and all IP multicast addresses. Sender IP addresses are checked in all ARP requests and responses, while target IP addresses are checked only in ARP responses.
 - Source MAC – Checks the source MAC address in the Ethernet header against the sender MAC address in the ARP body. This check is performed on both ARP requests and responses. When enabled, packets with different MAC addresses are classified as invalid and are dropped.

ARP Inspection Logging

- ◆ By default, logging is active for ARP Inspection, and cannot be disabled.
- ◆ The administrator can configure the log facility rate.
- ◆ When the switch drops a packet, it places an entry in the log buffer, then generates a system message on a rate-controlled basis. After the system message is generated, the entry is cleared from the log buffer.
- ◆ Each log entry contains flow information, such as the receiving VLAN, the port number, the source and destination IP addresses, and the source and destination MAC addresses.
- ◆ If multiple, identical invalid ARP packets are received consecutively on the same VLAN, then the logging facility will only generate one entry in the log buffer and one corresponding system message.
- ◆ If the log buffer is full, the oldest entry will be replaced with the newest entry.

PARAMETERS

These parameters are displayed:

- ◆ **ARP Inspection Status** – Enables ARP Inspection globally.
(Default: Disabled)
- ◆ **ARP Inspection Validation** – Enables extended ARP Inspection Validation if any of the following options are enabled.
(Default: Disabled)
 - **Dst-MAC** – Validates the destination MAC address in the Ethernet header against the target MAC address in the body of ARP responses.
 - **IP** – Checks the ARP body for invalid and unexpected IP addresses. Sender IP addresses are checked in all ARP requests and responses, while target IP addresses are checked only in ARP responses.
 - **Allow Zeros** – Allows sender IP address to be 0.0.0.0.
 - **Src-MAC** – Validates the source MAC address in the Ethernet header against the sender MAC address in the ARP body. This check is performed on both ARP requests and responses.
- ◆ **Log Message Number** – The maximum number of entries saved in a log message. (Range: 0-256; Default: 5)
- ◆ **Log Interval** – The interval at which log messages are sent. (Range: 0-86400 seconds; Default: 1 second)

WEB INTERFACE

To configure global settings for ARP Inspection:

1. Click Security, ARP Inspection.
2. Select Configure General from the Step list.
3. Enable ARP inspection globally, enable any of the address validation options, and adjust any of the logging parameters if required.
4. Click Apply.

Figure 201: Configuring Global Settings for ARP Inspection

Security > ARP Inspection

Step: 1. Configure General

ARP Inspection Status Enabled

ARP Inspection Validation Dst-MAC IP Allow Zeros Src-MAC

Log Message Number (0-256) 5

Log Interval (0-86400) 1 sec

Apply Revert

CONFIGURING VLAN SETTINGS FOR ARP INSPECTION

Use the Security > ARP Inspection (Configure VLAN) page to enable ARP inspection for any VLAN and to specify the ARP ACL to use.

CLI REFERENCES

- ◆ "ARP Inspection" on page 948

COMMAND USAGE

ARP Inspection VLAN Filters (ACLs)

- ◆ By default, no ARP Inspection ACLs are configured and the feature is disabled.
- ◆ ARP Inspection ACLs are configured within the ARP ACL configuration page (see [page 369](#)).
- ◆ ARP Inspection ACLs can be applied to any configured VLAN.
- ◆ ARP Inspection uses the DHCP snooping bindings database for the list of valid IP-to-MAC address bindings. ARP ACLs take precedence over entries in the DHCP snooping bindings database. The switch first compares ARP packets to any specified ARP ACLs.
- ◆ If *Static* is specified, ARP packets are only validated against the selected ACL – packets are filtered according to any matching rules, packets not matching any rules are dropped, and the DHCP snooping bindings database check is bypassed.

- ◆ If *Static* is not specified, ARP packets are first validated against the selected ACL; if no ACL rules match the packets, then the DHCP snooping bindings database determines their validity.

PARAMETERS

These parameters are displayed:

- ◆ **ARP Inspection VLAN ID** – Selects any configured VLAN. (Default: 1)
- ◆ **ARP Inspection VLAN Status** – Enables ARP Inspection for the selected VLAN. (Default: Disabled)
- ◆ **ARP Inspection ACL Name**
 - *ARP ACL* – Allows selection of any configured ARP ACLs. (Default: None)
 - **Static** – When an ARP ACL is selected, and static mode also selected, the switch only performs ARP Inspection and bypasses validation against the DHCP Snooping Bindings database. When an ARP ACL is selected, but static mode is not selected, the switch first performs ARP Inspection and then validation against the DHCP Snooping Bindings database. (Default: Disabled)

WEB INTERFACE

To configure VLAN settings for ARP Inspection:

1. Click Security, ARP Inspection.
2. Select Configure VLAN from the Step list.
3. Enable ARP inspection for the required VLANs, select an ARP ACL filter to check for configured addresses, and select the Static option to bypass checking the DHCP snooping bindings database if required.
4. Click Apply.

Figure 202: Configuring VLAN Settings for ARP Inspection

Security > ARP Inspection

Step: 2. Configure VLAN

ARP Inspection VLAN ID: 1

ARP Inspection VLAN Status: Enabled

ARP Inspection ACL Name: aaa Static

Apply Revert

CONFIGURING INTERFACE SETTINGS FOR ARP INSPECTION

Use the Security > ARP Inspection (Configure Interface) page to specify the ports that require ARP inspection, and to adjust the packet inspection rate.

CLI REFERENCES

- ◆ ["ARP Inspection" on page 948](#)

PARAMETERS

These parameters are displayed:

- ◆ **Interface** – Port or trunk identifier.
- ◆ **Trust Status** – Configures the port as trusted or untrusted. (Default: Untrusted)

By default, all untrusted ports are subject to ARP packet rate limiting, and all trusted ports are exempt from ARP packet rate limiting.

Packets arriving on trusted interfaces bypass all ARP Inspection and ARP Inspection Validation checks and will always be forwarded, while those arriving on untrusted interfaces are subject to all configured ARP inspection tests.

- ◆ **Packet Rate Limit** – Sets the maximum number of ARP packets that can be processed by CPU per second on trusted or untrusted ports. (Range: 0-2048; Default: 15)

Setting the rate limit to "0" means that there is no restriction on the number of ARP packets that can be processed by the CPU.

The switch will drop all ARP packets received on a port which exceeds the configured ARP-packets-per-second rate limit.

WEB INTERFACE

To configure interface settings for ARP Inspection:

1. Click Security, ARP Inspection.
2. Select Configure Interface from the Step list.
3. Specify any untrusted ports which require ARP inspection, and adjust the packet inspection rate.
4. Click Apply.

Figure 203: Configuring Interface Settings for ARP Inspection

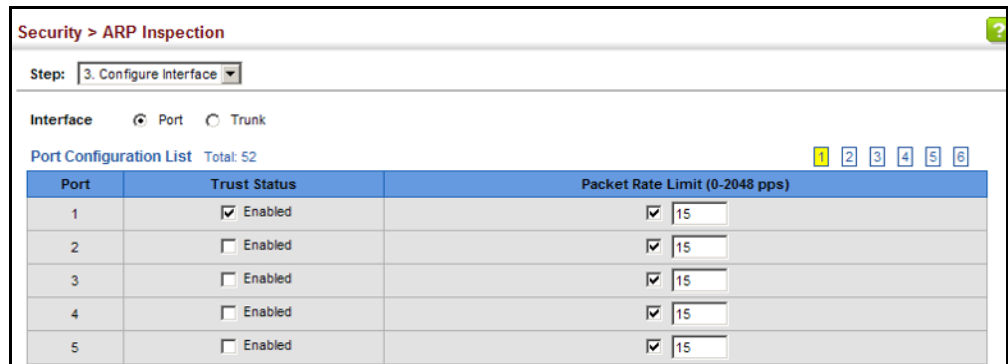

DISPLAYING ARP INSPECTION STATISTICS Use the Security > ARP Inspection (Show Information - Show Statistics) page to display statistics about the number of ARP packets processed, or dropped for various reasons.

CLI REFERENCES

- ◆ "show ip arp inspection statistics" on page 956

PARAMETERS

These parameters are displayed:

Table 22: ARP Inspection Statistics

Parameter	Description
Received ARP packets before ARP inspection rate limit	Count of ARP packets received but not exceeding the ARP Inspection rate limit.
Dropped ARP packets in the process of ARP inspection rate limit	Count of ARP packets exceeding (and dropped by) ARP rate limiting.
ARP packets dropped by additional validation (IP)	Count of ARP packets that failed the IP address test.
ARP packets dropped by additional validation (Dst-MAC)	Count of packets that failed the destination MAC address test.
Total ARP packets processed by ARP inspection	Count of all ARP packets processed by the ARP Inspection engine.
ARP packets dropped by additional validation (Src-MAC)	Count of packets that failed the source MAC address test.
ARP packets dropped by ARP ACLs	Count of ARP packets that failed validation against ARP ACL rules.
ARP packets dropped by DHCP snooping	Count of packets that failed validation against the DHCP Snooping Binding database.

WEB INTERFACE

To display statistics for ARP Inspection:

1. Click Security, ARP Inspection.
2. Select Show Information from the Step list.
3. Select Show Statistics from the Action list.

Figure 204: Displaying Statistics for ARP Inspection

Security > ARP Inspection	
Step:	4. Show Information
Action:	Show Statistics
Received ARP packets before ARP inspection rate limit	1000
Dropped ARP packets in processing ARP inspection rate limit	5
Total ARP packets processed by ARP inspection	200
ARP packets dropped by additional validation (Src-MAC)	300
ARP packets dropped by additional validation (Dst-MAC)	2000
ARP packets dropped by additional validation (IP)	100
ARP packets dropped by ARP ACLs	5
ARP packets dropped by DHCP snooping	5

DISPLAYING THE ARP INSPECTION LOG

Use the Security > ARP Inspection (Show Information - Show Log) page to show information about entries stored in the log, including the associated VLAN, port, and address components.

CLI REFERENCES

- ◆ ["show ip arp inspection log" on page 956](#)

PARAMETERS

These parameters are displayed:

Table 23: ARP Inspection Log

Parameter	Description
VLAN ID	The VLAN where this packet was seen.
Port	The port where this packet was seen.
Src. IP Address	The source IP address in the packet.
Dst. IP Address	The destination IP address in the packet.
Src. MAC Address	The source MAC address in the packet.
Dst. MAC Address	The destination MAC address in the packet.

WEB INTERFACE

To display the ARP Inspection log:

1. Click Security, ARP Inspection.
2. Select Show Information from the Step list.
3. Select Show Log from the Action list.

Figure 205: Displaying the ARP Inspection Log

The screenshot shows the 'Security > ARP Inspection' page. At the top, there are two dropdown menus: 'Step: 4. Show Information' and 'Action: Show Log'. Below this is a table titled 'ARP Inspection Log List' with a 'Total: 2' indicator. The table has six columns: VLAN ID, Port, Src. IP Address, Dst. IP Address, Src. MAC Address, and Dst. MAC Address. It contains two rows of data.

VLAN ID	Port	Src. IP Address	Dst. IP Address	Src. MAC Address	Dst. MAC Address
1	15	192.168.1.1	192.168.1.5	11-22-33-44-55-66	AA-BB-CC-DD-EE-FF
1	17	192.168.1.3	192.168.1.23	11-4E-33-75-55-BB	A0-3B-C9-DD-4E-1F

FILTERING IP ADDRESSES FOR MANAGEMENT ACCESS

Use the Security > IP Filter page to create a list of up to 15 IP addresses or IP address groups that are allowed management access to the switch through the web interface, SNMP, or Telnet.

CLI REFERENCES

- ◆ ["Management IP Filter" on page 878](#)

COMMAND USAGE

- ◆ The management interfaces are open to all IP addresses by default. Once you add an entry to a filter list, access to that interface is restricted to the specified addresses.
- ◆ If anyone tries to access a management interface on the switch from an invalid address, the switch will reject the connection, enter an event message in the system log, and send a trap message to the trap manager.
- ◆ IP address can be configured for SNMP, web and Telnet access respectively. Each of these groups can include up to five different sets of addresses, either individual addresses or address ranges.
- ◆ When entering addresses for the same group (i.e., SNMP, web or Telnet), the switch will not accept overlapping address ranges. When entering addresses for different groups, the switch will accept overlapping address ranges.
- ◆ You cannot delete an individual address from a specified range. You must delete the entire range, and reenter the addresses.

- ◆ You can delete an address range just by specifying the start address, or by specifying both the start address and end address.

PARAMETERS

These parameters are displayed:

- ◆ **Mode**

- **Web** – Configures IP address(es) for the web group.
- **SNMP** – Configures IP address(es) for the SNMP group.
- **Telnet** – Configures IP address(es) for the Telnet group.
- **All** – Configures IP address(es) for all groups.

- ◆ **Start IP Address** – A single IP address, or the starting address of a range.

- ◆ **End IP Address** – The end address of a range.

WEB INTERFACE

To create a list of IP addresses authorized for management access:

1. Click Security, IP Filter.
2. Select Add from the Action list.
3. Select the management interface to filter (Web, SNMP, Telnet, All).
4. Enter the IP addresses or range of addresses that are allowed management access to an interface.
5. Click Apply

Figure 206: Creating an IP Address Filter for Management Access

The screenshot shows the 'Security > IP Filter' configuration page. At the top, there is a breadcrumb 'Security > IP Filter'. Below it, the 'Action' is set to 'Add'. The 'Mode' section has four radio buttons: 'Web' (selected), 'SNMP', 'Telnet', and 'All'. The 'Start IP Address' field contains '10.1.2.3' and the 'End IP Address' field is empty. At the bottom right, there are 'Apply' and 'Revert' buttons.

To show a list of IP addresses authorized for management access:

1. Click Security, IP Filter.
2. Select Show from the Action list.

Figure 207: Showing IP Addresses Authorized for Management Access

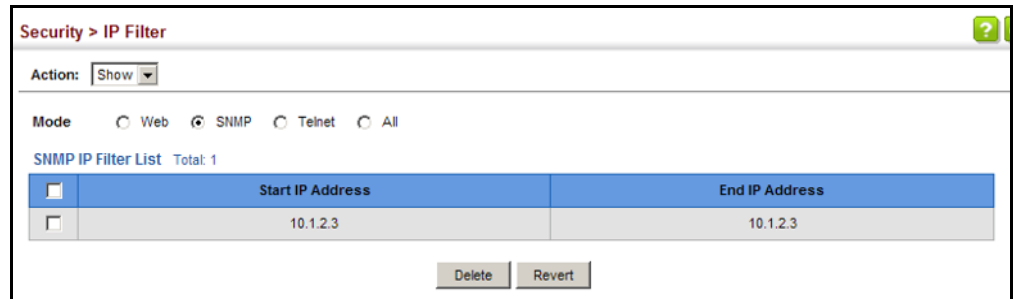

CONFIGURING PORT SECURITY

Use the Security > Port Security page to configure the maximum number of device MAC addresses that can be learned by a switch port, stored in the address table, and authorized to access the network.

When port security is enabled on a port, the switch stops learning new MAC addresses on the specified port when it has reached a configured maximum number. Only incoming traffic with source addresses already stored in the address table will be authorized to access the network through that port. If a device with an unauthorized MAC address attempts to use the switch port, the intrusion will be detected and the switch can automatically take action by disabling the port and sending a trap message.

CLI REFERENCES

- ◆ "Port Security" on page 890

COMMAND USAGE

- ◆ The default maximum number of MAC addresses allowed on a secure port is zero (that is, disabled). To use port security, you must configure the maximum number of addresses allowed on a port.
- ◆ To configure the maximum number of address entries which can be learned on a port, and then specify the maximum number of dynamic addresses allowed. The switch will learn up to the maximum number of allowed address pairs <source MAC address, VLAN> for frames received on the port. When the port has reached the maximum number of MAC addresses, the port will stop learning new addresses. The MAC addresses already in the address table will be retained and will not be aged out.

Note that you can manually add additional secure addresses to a port using the Static Address Table (page 233).

- ◆ When the port security state is changed from enabled to disabled, all dynamically learned entries are cleared from the address table.
- ◆ If port security is enabled, and the maximum number of allowed addresses are set to a non-zero value, any device not in the address table that attempts to use the port will be prevented from accessing the switch.
- ◆ If a port is disabled (shut down) due to a security violation, it must be manually re-enabled from the Interface > Port > General page ([page 156](#)).
- ◆ A secure port has the following restrictions:
 - It cannot be used as a member of a static or dynamic trunk.
 - It should not be connected to a network interconnection device.
 - RSPAN and port security are mutually exclusive functions. If port security is enabled on a port, that port cannot be set as an RSPAN uplink port, source port, or destination port. Also, when a port is configured as an RSPAN uplink port, source port, or destination port, port security cannot be enabled on that port.

PARAMETERS

These parameters are displayed:

- ◆ **Port** – Port identifier.
- ◆ **Security Status** – Enables or disables port security on the port. (Default: Disabled)
- ◆ **Port Status** – The operational status:
 - Secure/Down – Port security is disabled.
 - Secure/Up – Port security is enabled.
 - Shutdown – Port is shut down due to a response to a port security violation.
- ◆ **Action** – Indicates the action to be taken when a port security violation is detected:
 - **None**: No action should be taken. (This is the default.)
 - **Trap**: Send an SNMP trap message.
 - **Shutdown**: Disable the port.
 - **Trap and Shutdown**: Send an SNMP trap message and disable the port.
- ◆ **Max MAC Count** – The maximum number of MAC addresses that can be learned on a port. (Range: 0 - 1024, where 0 means disabled)
The maximum address count is effective when port security is enabled or disabled.

- ◆ **Current MAC Count** – The number of MAC addresses currently associated with this interface.
- ◆ **MAC Filter** – Shows if MAC address filtering has been set under Security > Network Access (Configure MAC Filter) as described on page 337.
- ◆ **MAC Filter ID** – The identifier for a MAC address filter.
- ◆ **Last Intrusion MAC** – The last unauthorized MAC address detected.
- ◆ **Last Time Detected Intrusion MAC** – The last time an unauthorized MAC address was detected.

WEB INTERFACE

To configure port security:

1. Click Security, Port Security.
2. Mark the check box in the Security Status column to enable security, set the action to take when an invalid address is detected on a port, and set the maximum number of MAC addresses allowed on the port.
3. Click Apply.

Figure 208: Configuring Port Security

The screenshot shows the 'Security > Port Security' web interface. At the top, it says 'Port Security List Total: 52'. Below this is a table with 10 columns: Port, Security Status, Port Status, Action, Max MAC Count (0-1024), Current MAC Count, MAC Filter, MAC Filter ID, Last Intrusion MAC, and Last Time Detected Intrusion MAC. There are five rows representing ports 1 through 5. Port 1 has Security Status 'Enabled', Port Status 'Secure/Up', Action 'Trap and Shutdown', Max MAC Count '0', Current MAC Count '0', MAC Filter 'Disabled', MAC Filter ID '0', Last Intrusion MAC 'NA', and Last Time Detected Intrusion MAC 'NA'. Port 2 has Security Status 'Enabled', Port Status 'Secure/Up', Action 'Trap', Max MAC Count '0', Current MAC Count '0', MAC Filter 'Enabled', MAC Filter ID '1', Last Intrusion MAC 'NA', and Last Time Detected Intrusion MAC 'NA'. Ports 3, 4, and 5 all have Security Status 'Enabled', Port Status 'Secure/Down', Action 'None', Max MAC Count '0', Current MAC Count '0', MAC Filter 'Disabled', MAC Filter ID '0', Last Intrusion MAC 'NA', and Last Time Detected Intrusion MAC 'NA'.

Port	Security Status	Port Status	Action	Max MAC Count (0-1024)	Current MAC Count	MAC Filter	MAC Filter ID	Last Intrusion MAC	Last Time Detected Intrusion MAC
1	<input checked="" type="checkbox"/> Enabled	Secure/Up	Trap and Shutdown	0	0	Disabled	0	NA	NA
2	<input checked="" type="checkbox"/> Enabled	Secure/Up	Trap	0	0	Enabled	1	NA	NA
3	<input type="checkbox"/> Enabled	Secure/Down	None	0	0	Disabled	0	NA	NA
4	<input type="checkbox"/> Enabled	Secure/Down	None	0	0	Disabled	0	NA	NA
5	<input type="checkbox"/> Enabled	Secure/Down	None	0	0	Disabled	0	NA	NA

CONFIGURING 802.1X PORT AUTHENTICATION

Network switches can provide open and easy access to network resources by simply attaching a client PC. Although this automatic configuration and access is a desirable feature, it also allows unauthorized personnel to easily intrude and possibly gain access to sensitive network data.

The IEEE 802.1X (dot1X) standard defines a port-based access control procedure that prevents unauthorized access to a network by requiring

users to first submit credentials for authentication. Access to all switch ports in a network can be centrally controlled from a server, which means that authorized users can use the same credentials for authentication from any point within the network.

This switch uses the Extensible Authentication Protocol over LANs (EAPOL) to exchange authentication protocol messages with the client, and a remote RADIUS authentication server to verify user identity and access rights. When a client (i.e., Supplicant) connects to a switch port, the switch (i.e., Authenticator) responds with an EAPOL identity request. The client provides its identity (such as a user name) in an EAPOL response to the switch, which it forwards to the RADIUS server. The RADIUS server verifies the client identity and sends an access challenge back to the client. The EAP packet from the RADIUS server contains not only the challenge, but the authentication method to be used. The client can reject the authentication method and request another, depending on the configuration of the client software and the RADIUS server. The encryption method used to pass authentication messages can be MD5 (Message-Digest 5), TLS (Transport Layer Security), PEAP (Protected Extensible Authentication Protocol), or TTLS (Tunneled Transport Layer Security). The client responds to the appropriate method with its credentials, such as a password or certificate. The RADIUS server verifies the client credentials and responds with an accept or reject packet. If authentication is successful, the switch allows the client to access the network. Otherwise, non-EAP traffic on the port is blocked or assigned to a guest VLAN based on the "intrusion-action" setting. In "multi-host" mode, only one host connected to a port needs to pass authentication for all other hosts to be granted network access. Similarly, a port can become unauthorized for all hosts if one attached host fails re-authentication or sends an EAPOL logoff message.

Figure 209: Configuring Port Authentication

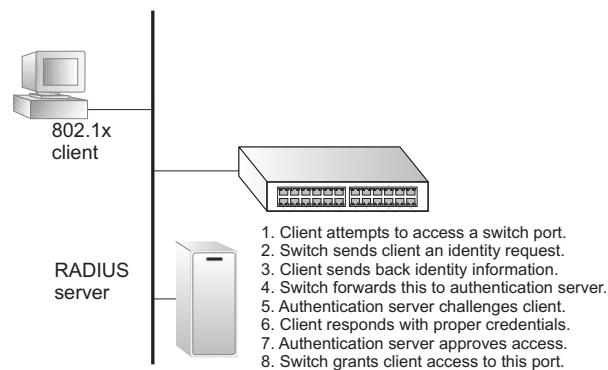

The operation of 802.1X on the switch requires the following:

- ◆ The switch must have an IP address assigned.
- ◆ RADIUS authentication must be enabled on the switch and the IP address of the RADIUS server specified.
- ◆ 802.1X must be enabled globally for the switch.

- ◆ Each switch port that will be used must be set to dot1X "Auto" mode.
- ◆ Each client that needs to be authenticated must have dot1X client software installed and properly configured.
- ◆ The RADIUS server and 802.1X client support EAP. (The switch only supports EAPOL in order to pass the EAP packets from the server to the client.)
- ◆ The RADIUS server and client also have to support the same EAP authentication type – MD5, PEAP, TLS, or TTLS. (Native support for these encryption methods is provided in Windows 8, 7, Vista and XP, and in Windows 2000 with Service Pack 4. To support these encryption methods in Windows 95 and 98, you can use the AEGIS dot1x client or other comparable client software)

CONFIGURING 802.1X GLOBAL SETTINGS

Use the Security > Port Authentication (Configure Global) page to configure IEEE 802.1X port authentication. The 802.1X protocol must be enabled globally for the switch system before port settings are active.

CLI REFERENCES

- ◆ ["802.1X Port Authentication" on page 862](#)

PARAMETERS

These parameters are displayed:

- ◆ **System Authentication Control** – Sets the global setting for 802.1X. (Default: Disabled)
- ◆ **EAPOL Pass Through** – Passes EAPOL frames through to all ports in STP forwarding state when dot1x is globally disabled. (Default: Disabled)

When this device is functioning as intermediate node in the network and does not need to perform dot1x authentication, **EAPOL Pass Through** can be enabled to allow the switch to forward EAPOL frames from other switches on to the authentication servers, thereby allowing the authentication process to still be carried out by switches located on the edge of the network.

When this device is functioning as an edge switch but does not require any attached clients to be authenticated, **EAPOL Pass Through** can be disabled to discard unnecessary EAPOL traffic.

- ◆ **Identity Profile User Name** – The dot1x supplicant user name. (Range: 1-8 characters)

The global supplicant user name and password are used to identify this switch as a supplicant when responding to an MD5 challenge from the authenticator. These parameters must be set when this switch passes client authentication requests to another authenticator on the network (see ["Configuring Port Supplicant Settings for 802.1X" on page 394](#)).

- ◆ **Set Password** – Allows the dot1x supplicant password to be entered.

- ◆ **Identity Profile Password** – The dot1x supplicant password used to identify this switch as a supplicant when responding to an MD5 challenge from the authenticator. (Range: 1-8 characters)
- ◆ **Confirm Profile Password** – This field is used to confirm the dot1x supplicant password.
- ◆ **Default** – Sets all configurable 802.1X global and port settings to their default values.

WEB INTERFACE

To configure global settings for 802.1X:

1. Click Security, Port Authentication.
2. Select Configure Global from the Step list.
3. Enable 802.1X globally for the switch, and configure EAPOL Pass Through if required. Then set the user name and password to use when the switch responds an MD5 challenge from the authentication server.
4. Click Apply

Figure 210: Configuring Global Settings for 802.1X Port Authentication

The screenshot shows the 'Security > Port Authentication' configuration page. At the top, the 'Step' is set to '1. Configure Global'. Below this, there are several configuration options:

- System Authentication Control**: Enabled
- EAPOL Pass Through**: Enabled
- Identity Profile User Name**:
- Set Password**:
- Identity Profile Password**:
- Confirm Profile Password**:

At the bottom right, there are 'Apply' and 'Revert' buttons. At the bottom left, there is a 'Default' button with a tooltip that says 'Click this button to set 802.1X global/port settings to default values.'

CONFIGURING PORT AUTHENTICATOR SETTINGS FOR 802.1X

Use the Security > Port Authentication (Configure Interface – Authenticator) page to configure 802.1X port settings for the switch as the local authenticator. When 802.1X is enabled, you need to configure the parameters for the authentication process that runs between the client and the switch (i.e., authenticator), as well as the client identity lookup process that runs between the switch and authentication server.

CLI REFERENCES

- ◆ "802.1X Port Authentication" on page 862

COMMAND USAGE

- ◆ When the switch functions as a local authenticator between supplicant devices attached to the switch and the authentication server, configure the parameters for the exchange of EAP messages between the authenticator and clients on the Authenticator configuration page.
- ◆ When devices attached to a port must submit requests to another authenticator on the network, configure the Identity Profile parameters on the Configure Global page (see "[Configuring 802.1X Global Settings](#)" on page 389) which identify this switch as a supplicant, and configure the supplicant parameters for those ports which must authenticate clients through the remote authenticator (see "[Configuring Port Supplicant Settings for 802.1X](#)" on page 394).
- ◆ This switch can be configured to serve as the authenticator on selected ports by setting the Control Mode to Auto on this configuration page, and as a supplicant on other ports by the setting the control mode to Force-Authorized on this page and enabling the PAE supplicant on the Supplicant configuration page.

PARAMETERS

These parameters are displayed:

- ◆ **Port** – Port number.
- ◆ **Status** – Indicates if authentication is enabled or disabled on the port. The status is disabled if the control mode is set to Force-Authorized.
- ◆ **Authorized** – Displays the 802.1X authorization status of connected clients.
 - **Yes** – Connected client is authorized.
 - **N/A** – Connected client is not authorized, or port is not connected.
- ◆ **Control Mode** – Sets the authentication mode to one of the following options:
 - **Auto** – Requires a dot1x-aware client to be authorized by the authentication server. Clients that are not dot1x-aware will be denied access.
 - **Force-Authorized** – Forces the port to grant access to all clients, either dot1x-aware or otherwise. (This is the default setting.)
 - **Force-Unauthorized** – Forces the port to deny access to all clients, either dot1x-aware or otherwise.
- ◆ **Operation Mode** – Allows single or multiple hosts (clients) to connect to an 802.1X-authorized port. (Default: Single-Host)
 - **Single-Host** – Allows only a single host to connect to this port.
 - **Multi-Host** – Allows multiple host to connect to this port.

In this mode, only one host connected to a port needs to pass authentication for all other hosts to be granted network access. Similarly, a port can become unauthorized for all hosts if one attached host fails re-authentication or sends an EAPOL logoff message.

- **MAC-Based** – Allows multiple hosts to connect to this port, with each host needing to be authenticated.

In this mode, each host connected to a port needs to pass authentication. The number of hosts allowed access to a port operating in this mode is limited only by the available space in the secure address table (i.e., up to 1024 addresses).

- ◆ **Max Count** – The maximum number of hosts that can connect to a port when the Multi-Host operation mode is selected. (Range: 1-1024; Default: 5)
- ◆ **Max Request** – Sets the maximum number of times the switch port will retransmit an EAP request packet to the client before it times out the authentication session. (Range: 1-10; Default 2)
- ◆ **Quiet Period** – Sets the time that a switch port waits after the Max Request Count has been exceeded before attempting to acquire a new client. (Range: 1-65535 seconds; Default: 60 seconds)
- ◆ **Tx Period** – Sets the time period during an authentication session that the switch waits before re-transmitting an EAP packet. (Range: 1-65535; Default: 30 seconds)
- ◆ **Supplicant Timeout** – Sets the time that a switch port waits for a response to an EAP request from a client before re-transmitting an EAP packet. (Range: 1-65535; Default: 30 seconds)

This command attribute sets the timeout for EAP-request frames other than EAP-request/identity frames. If dot1x authentication is enabled on a port, the switch will initiate authentication when the port link state comes up. It will send an EAP-request/identity frame to the client to request its identity, followed by one or more requests for authentication information. It may also send other EAP-request frames to the client during an active connection as required for reauthentication.

- ◆ **Server Timeout** – Sets the time that a switch port waits for a response to an EAP request from an authentication server before re-transmitting an EAP packet. (Default: 0 seconds)

A RADIUS server must be set before the correct operational value of 10 seconds will be displayed in this field. (See "[Configuring Remote Logon Authentication Servers](#)" on page 312.)

- ◆ **Re-authentication Status** – Sets the client to be re-authenticated after the interval specified by the Re-authentication Period. Re-authentication can be used to detect if a new device is plugged into a switch port. (Default: Disabled)

- ◆ **Re-authentication Period** – Sets the time period after which a connected client must be re-authenticated. (Range: 1-65535 seconds; Default: 3600 seconds)
- ◆ **Re-authentication Max Retries** – The maximum number of times the switch port will retransmit an EAP request/identity packet to the client before it times out the authentication session. (Range: 1-10; Default: 2)
- ◆ **Intrusion Action** – Sets the port's response to a failed authentication.
 - **Block Traffic** – Blocks all non-EAP traffic on the port. (This is the default setting.)
 - **Guest VLAN** – All traffic for the port is assigned to a guest VLAN. The guest VLAN must be separately configured (See "[Configuring VLAN Groups](#)" on page 202) and mapped on each port (See "[Configuring Network Access for Ports](#)" on page 334).

Supplicant List

- ◆ **Supplicant** – MAC address of authorized client.

Authenticator PAE State Machine

- ◆ **State** – Current state (including initialize, disconnected, connecting, authenticating, authenticated, aborting, held, force_authorized, force_unauthorized).
- ◆ **Reauth Count** – Number of times connecting state is re-entered.
- ◆ **Current Identifier** – Identifier sent in each EAP Success, Failure or Request packet by the Authentication Server.

Backend State Machine

- ◆ **State** – Current state (including request, response, success, fail, timeout, idle, initialize).
- ◆ **Request Count** – Number of EAP Request packets sent to the Supplicant without receiving a response.
- ◆ **Identifier (Server)** – Identifier carried in the most recent EAP Success, Failure or Request packet received from the Authentication Server.

Reauthentication State Machine

- ◆ **State** – Current state (including initialize, reauthenticate).

WEB INTERFACE

To configure port authenticator settings for 802.1X:

1. Click Security, Port Authentication.
2. Select Configure Interface from the Step list.
3. Click Authenticator.
4. Modify the authentication settings for each port as required.
5. Click Apply

Figure 211: Configuring Interface Settings for 802.1X Port Authenticator

The screenshot shows the 'Security > Port Authentication' web interface. The 'Step' dropdown is set to '2. Configure Interface'. Under 'Type', 'Authenticator' is selected. The 'Port' is set to '1', 'Status' is 'Disabled', and 'Authorized' is 'Yes'. 'Control Mode' is 'Force-Authorized' and 'Operation Mode' is 'Single-Host'. Other settings include: Max Count (1-16384) = 5, Max Request (1-10) = 2, Quiet Period (1-65535) = 60 sec, Tx Period (1-65535) = 30 sec, Supplicant Timeout (1-65535) = 30 sec, Server Timeout = 0 sec, Re-authentication Status = Enabled, Re-authentication Period (1-65535) = 3600 sec, Re-authentication Max Retries (1-10) = 2, and Intrusion Action = Block Traffic.

Below the settings is a 'Supplicant List' table with a total of 1 entry:

Supplicant	Authenticator PAE State Machine			Backend State Machine		Reauthentication State Machine	
	State	Reauth Count	Current Identifier	State	Request Count	Identifier (Server)	State
00-00-00-00-00-00	Initialize	0	0	Initialize	0	0	Initialize

'Apply' and 'Revert' buttons are located at the bottom right of the interface.

CONFIGURING PORT SUPPLICANT SETTINGS FOR 802.1X

Use the Security > Port Authentication (Configure Interface – Supplicant) page to configure 802.1X port settings for supplicant requests issued from a port to an authenticator on another device. When 802.1X is enabled and the control mode is set to Force-Authorized (see ["Configuring Port Authenticator Settings for 802.1X" on page 390](#)), you need to configure the parameters for the client supplicant process if the client must be authenticated through another device in the network.

CLI REFERENCES

- ◆ ["802.1X Port Authentication" on page 862](#)

COMMAND USAGE

- ◆ When devices attached to a port must submit requests to another authenticator on the network, configure the Identity Profile parameters on the Configure Global page (see ["Configuring 802.1X Global Settings" on page 389](#)) which identify this switch as a supplicant, and configure the supplicant parameters for those ports which must authenticate clients through the remote authenticator on this configuration page. When PAE supplicant mode is enabled on a port, it will not respond to dot1x messages meant for an authenticator.
- ◆ This switch can be configured to serve as the authenticator on selected ports by setting the Control Mode to Auto on the Authenticator configuration page, and as a supplicant on other ports by the setting the control mode to Force-Authorized on that configuration page and enabling the PAE supplicant on the Supplicant configuration page.

PARAMETERS

These parameters are displayed:

- ◆ **Port** – Port number.
- ◆ **PAE Supplicant** – Enables PAE supplicant mode. (Default: Disabled)
If the attached client must be authenticated through another device in the network, supplicant status must be enabled.
Supplicant status can only be enabled if PAE Control Mode is set to "Force-Authorized" on this port (see ["Configuring Port Authenticator Settings for 802.1X" on page 390](#)).
PAE supplicant status cannot be enabled if a port is a member of trunk or LACP is enabled on the port.
- ◆ **Authentication Period** – The time that a supplicant port waits for a response from the authenticator. (Range: 1-65535 seconds; Default: 30 seconds)
- ◆ **Held Period** – The time that a supplicant port waits before re-sending its credentials to find a new an authenticator. (Range: 1-65535 seconds; Default: 30 seconds)
- ◆ **Start Period** – The time that a supplicant port waits before re-sending an EAPOL start frame to the authenticator. (Range: 1-65535 seconds; Default: 30 seconds)
- ◆ **Maximum Start** – The maximum number of times that a port supplicant will send an EAP start frame to the client before assuming that the client is 802.1X unaware. (Range: 1-65535; Default: 3)
- ◆ **Authenticated** – Shows whether or not the supplicant has been authenticated.

WEB INTERFACE

To configure port authenticator settings for 802.1X:

1. Click Security, Port Authentication.
2. Select Configure Interface from the Step list.
3. Click Supplicant.
4. Modify the supplicant settings for each port as required.
5. Click Apply

Figure 212: Configuring Interface Settings for 802.1X Port Supplicant

DISPLAYING 802.1X STATISTICS Use the Security > Port Authentication (Show Statistics) page to display statistics for dot1x protocol exchanges for any port.

CLI REFERENCES

- ◆ ["show dot1x" on page 875](#)

PARAMETERS

These parameters are displayed:

Table 24: 802.1X Statistics

Parameter	Description
<i>Authenticator</i>	
Rx EAPOL Start	The number of EAPOL Start frames that have been received by this Authenticator.
Rx EAPOL Logoff	The number of EAPOL Logoff frames that have been received by this Authenticator.
Rx EAPOL Invalid	The number of EAPOL frames that have been received by this Authenticator in which the frame type is not recognized.
Rx EAPOL Total	The number of valid EAPOL frames of any type that have been received by this Authenticator.

Table 24: 802.1X Statistics (Continued)

Parameter	Description
Rx Last EAPOLVer	The protocol version number carried in the most recent EAPOL frame received by this Authenticator.
Rx Last EAPOLSrc	The source MAC address carried in the most recent EAPOL frame received by this Authenticator.
Rx EAP Resp/Id	The number of EAP Resp/Id frames that have been received by this Authenticator.
Rx EAP Resp/Oth	The number of valid EAP Response frames (other than Resp/Id frames) that have been received by this Authenticator.
Rx EAP LenError	The number of EAPOL frames that have been received by this Authenticator in which the Packet Body Length field is invalid.
Tx EAP Req/Id	The number of EAP Req/Id frames that have been transmitted by this Authenticator.
Tx EAP Req/Oth	The number of EAP Request frames (other than Rq/Id frames) that have been transmitted by this Authenticator.
Tx EAPOL Total	The number of EAPOL frames of any type that have been transmitted by this Authenticator.
<i>Supplicant</i>	
Rx EAPOL Invalid	The number of EAPOL frames that have been received by this Supplicant in which the frame type is not recognized.
Rx EAPOL Total	The number of valid EAPOL frames of any type that have been received by this Supplicant.
Rx Last EAPOLVer	The protocol version number carried in the most recent EAPOL frame received by this Supplicant.
Rx Last EAPOLSrc	The source MAC address carried in the most recent EAPOL frame received by this Supplicant.
Rx EAP Resp/Id	The number of EAP Resp/Id frames that have been received by this Supplicant.
Rx EAP Resp/Oth	The number of valid EAP Response frames (other than Resp/Id frames) that have been received by this Supplicant.
Rx EAP LenError	The number of EAPOL frames that have been received by this Supplicant in which the Packet Body Length field is invalid.
Tx EAPOL Total	The number of EAPOL frames of any type that have been transmitted by this Supplicant.
Tx EAPOL Start	The number of EAPOL Start frames that have been transmitted by this Supplicant.
Tx EAPOL Logoff	The number of EAPOL Logoff frames that have been transmitted by this Supplicant.
Tx EAP Req/Id	The number of EAP Req/Id frames that have been transmitted by this Supplicant.
Tx EAP Req/Oth	The number of EAP Request frames (other than Rq/Id frames) that have been transmitted by this Supplicant.

WEB INTERFACE

To display port authenticator statistics for 802.1X:

1. Click Security, Port Authentication.
2. Select Show Statistics from the Step list.
3. Click Authenticator.

Figure 213: Showing Statistics for 802.1X Port Authenticator

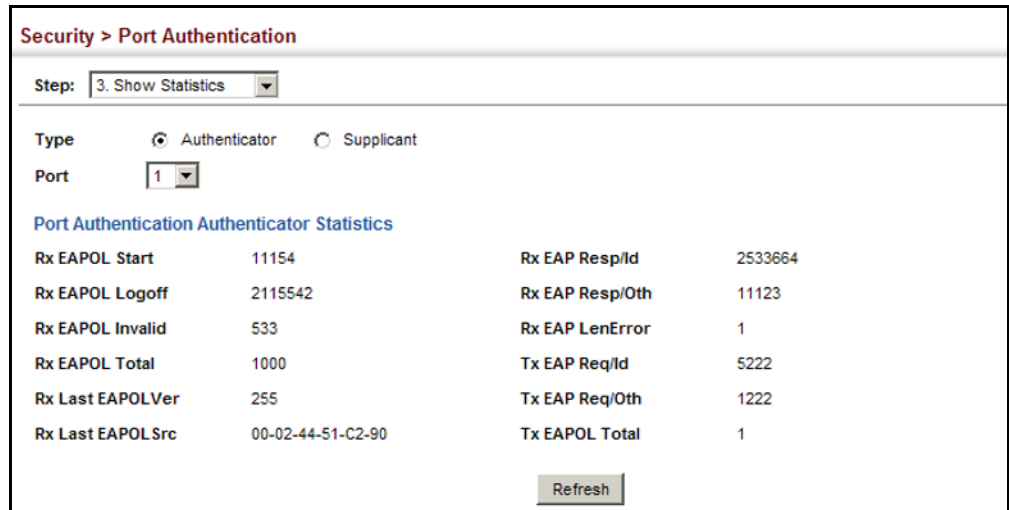

To display port supplicant statistics for 802.1X:

1. Click Security, Port Authentication.
2. Select Show Statistics from the Step list.
3. Click Supplicant.

Figure 214: Showing Statistics for 802.1X Port Supplicant

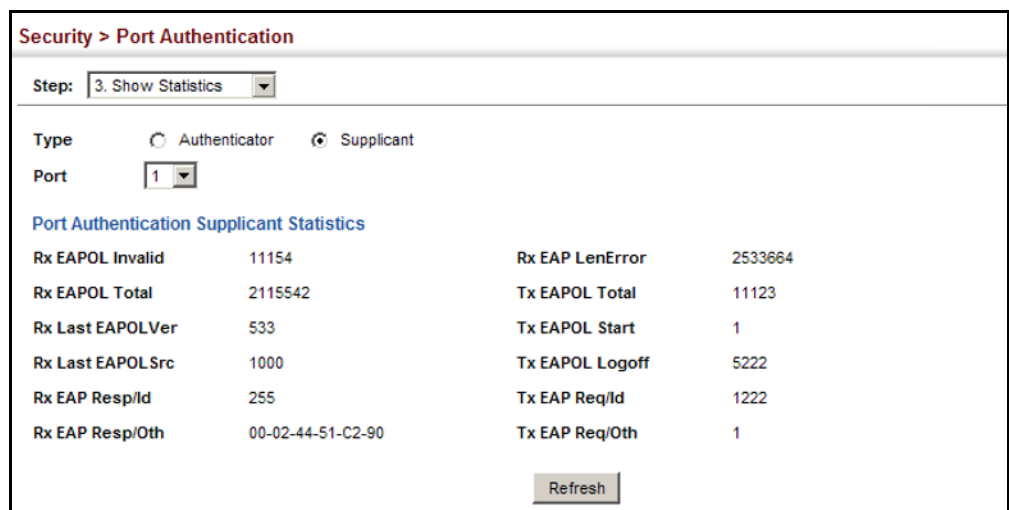

DoS PROTECTION

Use the Security > DoS Protection page to protect against denial-of-service (DoS) attacks. A DoS attack is an attempt to block the services provided by a computer or network resource. This kind of attack tries to prevent an Internet site or service from functioning efficiently or at all. In general, DoS attacks are implemented by either forcing the target to reset, to consume most of its resources so that it can no longer provide its intended service, or to obstruct the communication media between the intended users and the target so that they can no longer communicate adequately. This section describes how to protect against DoS attacks.

CLI REFERENCES

- ◆ ["Denial of Service Protection" on page 957](#)

PARAMETERS

These parameters are displayed:

- ◆ **Echo/Chargen Attack** – Attacks in which the echo service repeats anything sent to it, and the chargen (character generator) service generates a continuous stream of data. When used together, they create an infinite loop and result in a denial-of-service. (Default: Disabled)
- ◆ **Echo/Chargen Attack Rate** – Maximum allowed rate. (Range: 64-2000 kbits/second; Default: 1000 kbits/second)
- ◆ **Smurf Attack** – Attacks in which a perpetrator generates a large amount of spoofed ICMP Echo Request traffic to the broadcast destination IP address (255.255.255.255), all of which uses a spoofed source address of the intended victim. The victim should crash due to the many interrupts required to send ICMP Echo response packets. (Default: Enabled)
- ◆ **TCP Flooding Attack** – Attacks in which a perpetrator sends a succession of TCP SYN requests (with or without a spoofed-Source IP) to a target and never returns ACK packets. These half-open connections will bind resources on the target, and no new connections can be made, resulting in a denial of service. (Default: Disabled)
- ◆ **TCP Flooding Attack Rate** – Maximum allowed rate. (Range: 64-2000 kbits/second; Default: 1000 kbits/second)
- ◆ **TCP Null Scan** – A TCP NULL scan message is used to identify listening TCP ports. The scan uses a series of strangely configured TCP packets which contain a sequence number of 0 and no flags. If the target's TCP port is closed, the target replies with a TCP RST (reset) packet. If the target TCP port is open, it simply discards the TCP NULL scan. (Default: Enabled)
- ◆ **TCP-SYN/FIN Scan** – A TCP SYN/FIN scan message is used to identify listening TCP ports. The scan uses a series of strangely configured TCP packets which contain SYN (synchronize) and FIN (finish) flags. If the

target's TCP port is closed, the target replies with a TCP RST (reset) packet. If the target TCP port is open, it simply discards the TCP SYN FIN scan. (Default: Enabled)

- ◆ **TCP Xmas Scan** – A so-called TCP XMAS scan message is used to identify listening TCP ports. This scan uses a series of strangely configured TCP packets which contain a sequence number of 0 and the URG, PSH and FIN flags. If the target's TCP port is closed, the target replies with a TCP RST packet. If the target TCP port is open, it simply discards the TCP XMAS scan. (Default: Enabled)
- ◆ **UDP Flooding Attack** – Attacks in which a perpetrator sends a large number of UDP packets (with or without a spoofed-Source IP) to random ports on a remote host. The target will determine that application is listening at that port, and reply with an ICMP Destination Unreachable packet. It will be forced to send many ICMP packets, eventually leading it to be unreachable by other clients. (Default: Disabled)
- ◆ **UDP Flooding Attack Rate** – Maximum allowed rate. (Range: 64-2000 kbits/second; Default: 1000 kbits/second)
- ◆ **WinNuke Attack** – Attacks in which affected the Microsoft Windows 3.1x/95/NT operating systems. In this type of attack, the perpetrator sends the string of OOB out-of-band (OOB) packets contained a TCP URG flag to the target computer on TCP port 139 (NetBIOS), causing it to lock up and display a “Blue Screen of Death.” This did not cause any damage to, or change data on, the computer’s hard disk, but any unsaved data would be lost. Microsoft made patches to prevent the WinNuke attack, but the OOB packets. (Default: Disabled)
- ◆ **WinNuke Attack Rate** – Maximum allowed rate. (Range: 64-2000 kbits/second; Default: 1000 kbits/second)

WEB INTERFACE

To protect against DoS attacks:

1. Click Security, DoS Protection.
2. Enable protection for specific DoS attacks, and set the maximum allowed rate as required.
3. Click Apply

Figure 215: Protecting Against DoS Attacks

Security > DoS Protection	
Echo/Chargen Attack	<input type="checkbox"/> Enabled
Echo/Chargen Attack Rate (64-2000)	<input type="text" value="1000"/> kbps
Smurf Attack	<input checked="" type="checkbox"/> Enabled
TCP Flooding Attack	<input type="checkbox"/> Enabled
TCP Flooding Attack Rate (64-2000)	<input type="text" value="1000"/> kbps
TCP Null Scan	<input checked="" type="checkbox"/> Enabled
TCP SYN/FIN Scan	<input checked="" type="checkbox"/> Enabled
TCP Xmas Scan	<input checked="" type="checkbox"/> Enabled
UDP Flooding Attack	<input type="checkbox"/> Enabled
UDP Flooding Attack Rate (64-2000)	<input type="text" value="1000"/> kbps
WinNuke Attack	<input type="checkbox"/> Enabled
WinNuke Attack Rate (64-2000)	<input type="text" value="1000"/> kbps

IPv4 SOURCE GUARD

IPv4 Source Guard is a security feature that filters IP traffic on network interfaces based on manually configured entries in the IP Source Guard table, or dynamic entries in the DHCP Snooping table when enabled (see ["DHCP Snooping" on page 412](#)). IP source guard can be used to prevent traffic attacks caused when a host tries to use the IP address of a neighbor to access the network. This section describes how to configure IP Source Guard.

CONFIGURING PORTS FOR IPv4 SOURCE GUARD

Use the Security > IP Source Guard > Port Configuration page to set the filtering type based on source IP address, or source IP address and MAC address pairs.

IP Source Guard is used to filter traffic on an insecure port which receives messages from outside the network or fire wall, and therefore may be subject to traffic attacks caused by a host trying to use the IP address of a neighbor.

CLI REFERENCES

- ◆ ["ip source-guard" on page 938](#)

COMMAND USAGE

- ◆ Setting source guard mode to SIP (Source IP) or SIP-MAC (Source IP and MAC) enables this function on the selected port. Use the SIP option to check the VLAN ID, source IP address, and port number against all entries in the binding table. Use the SIP-MAC option to check these same parameters, plus the source MAC address. If no matching entry is found, the packet is dropped.



NOTE: Multicast addresses cannot be used by IP Source Guard.

- ◆ When enabled, traffic is filtered based upon dynamic entries learned via DHCP snooping (see "[DHCP Snooping](#)" on page 412), or static addresses configured in the source guard binding table.
- ◆ If IP source guard is enabled, an inbound packet's IP address (SIP option) or both its IP address and corresponding MAC address (SIP-MAC option) will be checked against the binding table. If no matching entry is found, the packet will be dropped.
- ◆ Filtering rules are implemented as follows:
 - If DHCP snooping is disabled (see page 415), IP source guard will check the VLAN ID, source IP address, port number, and source MAC address (for the SIP-MAC option). If a matching entry is found in the binding table and the entry type is static IP source guard binding, the packet will be forwarded.
 - If DHCP snooping is enabled, IP source guard will check the VLAN ID, source IP address, port number, and source MAC address (for the SIP-MAC option). If a matching entry is found in the binding table and the entry type is static IP source guard binding, or dynamic DHCP snooping binding, the packet will be forwarded.
 - If IP source guard is enabled on an interface for which IP source bindings have not yet been configured (neither by static configuration in the IP source guard binding table nor dynamically learned from DHCP snooping), the switch will drop all IP traffic on that port, except for DHCP packets.

PARAMETERS

These parameters are displayed:

- ◆ **Filter Type** – Configures the switch to filter inbound traffic based source IP address, or source IP address and corresponding MAC address. (Default: None)
 - **None** – Disables IP source guard filtering on the port.
 - **SIP** – Enables traffic filtering based on IP addresses stored in the binding table.
 - **SIP-MAC** – Enables traffic filtering based on IP addresses and corresponding MAC addresses stored in the binding table.
- ◆ **Max Binding Entry** – The maximum number of entries that can be bound to an interface. (Range: 1-5; Default: 5)

This parameter sets the maximum number of address entries that can be mapped to an interface in the binding table, including both dynamic entries discovered by DHCP snooping (see "[DHCP Snooping](#)" on

page 412) and static entries set by IP source guard (see "Configuring Static Bindings for IPv4 Source Guard" on page 403).

WEB INTERFACE

To set the IP Source Guard filter for ports:

1. Click Security, IP Source Guard, Port Configuration.
2. Set the required filtering type for each port.
3. Click Apply

Figure 216: Setting the Filter Type for IPv4 Source Guard

Port	Filter Type	Max Binding Entry (1-5)
1	None	5
2	None	5
3	None	5
4	None	5
5	SIP	3

CONFIGURING STATIC BINDINGS FOR IPV4 SOURCE GUARD

Use the Security > IP Source Guard > Static Binding page to bind a static address to a port. Table entries include a MAC address, IP address, lease time, entry type (Static, Dynamic), VLAN identifier, and port identifier. All static entries are configured with an infinite lease time, which is indicated with a value of zero in the table.

CLI REFERENCES

- ◆ "ip source-guard binding" on page 936

COMMAND USAGE

- ◆ Static addresses entered in the source guard binding table are automatically configured with an infinite lease time. Dynamic entries learned via DHCP snooping are configured by the DHCP server itself.
- ◆ Static bindings are processed as follows:
 - If there is no entry with the same VLAN ID and MAC address, a new entry is added to the binding table using the type "static IP source guard binding."
 - If there is an entry with the same VLAN ID and MAC address, and the type of entry is static IP source guard binding, then the new entry will replace the old one.
 - If there is an entry with the same VLAN ID and MAC address, and the type of the entry is dynamic DHCP snooping binding, then the new entry will replace the old one and the entry type will be changed to static IP source guard binding.

- Only unicast addresses are accepted for static bindings.

PARAMETERS

These parameters are displayed:

Add

- ◆ **Port** – The port to which a static entry is bound.
- ◆ **VLAN** – ID of a configured VLAN (Range: 1-4094)
- ◆ **MAC Address** – A valid unicast MAC address.
- ◆ **IP Address** – A valid unicast IP address, including classful types A, B or C.

Show

- ◆ **VLAN** – VLAN to which this entry is bound.
- ◆ **MAC Address** – Physical address associated with the entry.
- ◆ **Interface** – The port to which this entry is bound.
- ◆ **IP Address** – IP address corresponding to the client.
- ◆ **Lease Time** – The time for which this IP address is leased to the client. (This value is zero for all static addresses.)

WEB INTERFACE

To configure static bindings for IP Source Guard:

1. Click Security, IP Source Guard, Static Binding.
2. Select Add from the Action list.
3. Enter the required bindings for each port.
4. Click Apply

Figure 217: Configuring Static Bindings for IPv4 Source Guard

Security > IP Source Guard > Static Binding

Action: Add

Port: 1

VLAN: 1

MAC Address: 00-10-B5-F4-00-01

IP Address: 10.2.44.96

Apply Revert

To display static bindings for IP Source Guard:

1. Click Security, IP Source Guard, Static Binding.
2. Select Show from the Action list.

Figure 218: Displaying Static Bindings for IPv4 Source Guard

<input type="checkbox"/>	VLAN	MAC Address	Interface	IP Address	Lease Time (sec)
<input type="checkbox"/>	1	00-10-B5-F4-00-01	Unit 1 / Port 1	192.168.0.23	0

**DISPLAYING
INFORMATION FOR
DYNAMIC IPv4
SOURCE GUARD
BINDINGS**

Use the Security > IP Source Guard > Dynamic Binding page to display the source-guard binding table for a selected interface.

CLI REFERENCES

- ◆ "show ip source-guard binding" on page 942

PARAMETERS

These parameters are displayed:

Query by

- ◆ **Port** – A port on this switch.
- ◆ **VLAN** – ID of a configured VLAN (Range: 1-4094)
- ◆ **MAC Address** – A valid unicast MAC address.
- ◆ **IP Address** – A valid unicast IP address, including classful types A, B or C.

Dynamic Binding List

- ◆ **VLAN** – VLAN to which this entry is bound.
- ◆ **MAC Address** – Physical address associated with the entry.
- ◆ **Interface** – Port to which this entry is bound.
- ◆ **IP Address** – IP address corresponding to the client.
- ◆ **Lease Time** – The time for which this IP address is leased to the client.

WEB INTERFACE

To display the binding table for IP Source Guard:

1. Click Security, IP Source Guard, Dynamic Binding.
2. Mark the search criteria, and enter the required values.
3. Click Query

Figure 219: Showing the IPv4 Source Guard Binding Table

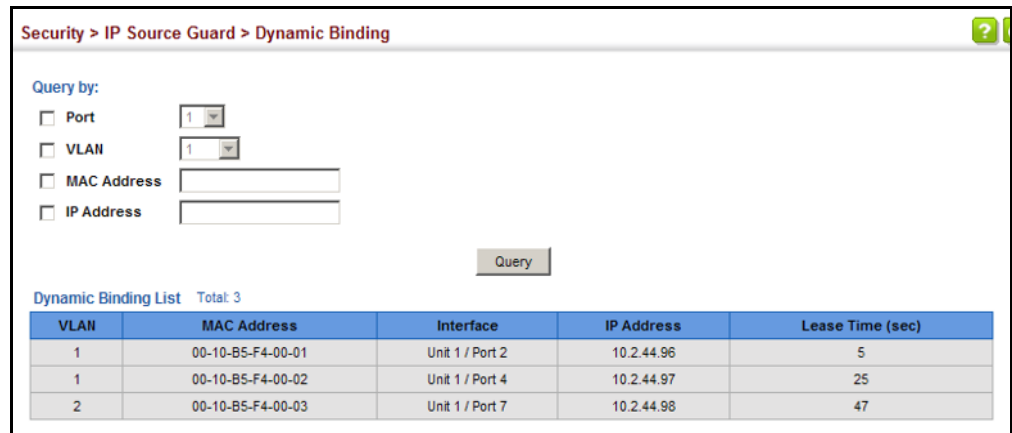

IPv6 SOURCE GUARD

IPv6 Source Guard is a security feature that filters IPv6 traffic on non-routed, Layer 2 network interfaces based on manually configured entries in the IPv6 Source Guard table, or dynamic entries in the Neighbor Discovery Snooping table or DHCPv6 Snooping table when either snooping protocol is enabled (see the [DHCPv6 Snooping](#) commands). IPv6 source guard can be used to prevent traffic attacks caused when a host tries to use the IPv6 address of a neighbor to access the network. This section describes how to configure IPv6 Source Guard.

CONFIGURING PORTS FOR IPv6 SOURCE GUARD

Use the Security > IPv6 Source Guard > Port Configuration page to filter inbound traffic based on the source IPv6 address stored in the binding table.

IPv6 Source Guard is used to filter traffic on an insecure port which receives messages from outside the network or fire wall, and therefore may be subject to traffic attacks caused by a host trying to use the IPv6 address of a neighbor.

CLI REFERENCES

- ◆ "[ipv6 source-guard](#)" on page 945

COMMAND USAGE

- ◆ Setting source guard mode to SIP (Source IP) enables this function on the selected port. Use the SIP option to check the VLAN ID, IPv6 global unicast source IP address, and port number against all entries in the binding table.
- ◆ After IPv6 source guard is enabled on an interface, the switch initially blocks all IPv6 traffic received on that interface, except for ND packets allowed by ND snooping and DHCPv6 packets allowed by DHCPv6 snooping. A port access control list (ACL) is applied to the interface. Traffic is then filtered based upon dynamic entries learned via ND snooping or DHCPv6 snooping, or static addresses configured in the source guard binding table. The port allows only IPv6 traffic with a matching entry in the binding table and denies all other IPv6 traffic.
- ◆ Table entries include a MAC address, IPv6 global unicast address, entry type (Static-IPv6-SG-Binding, Dynamic-ND-Binding, Dynamic-DHCPv6-Binding), VLAN identifier, and port identifier.
- ◆ Static addresses entered in the source guard binding table (using the Static Binding page) are automatically configured with an infinite lease time. Dynamic entries learned via DHCPv6 snooping are configured by the DHCPv6 server itself.
- ◆ If IPv6 source guard is enabled, an inbound packet's source IPv6 address will be checked against the binding table. If no matching entry is found, the packet will be dropped.
- ◆ Filtering rules are implemented as follows:
 - If ND snooping and DHCPv6 snooping are disabled, IPv6 source guard will check the VLAN ID, source IPv6 address, and port number. If a matching entry is found in the binding table and the entry type is static IPv6 source guard binding, the packet will be forwarded.
 - If ND snooping or DHCP snooping is enabled, IPv6 source guard will check the VLAN ID, source IP address, and port number. If a matching entry is found in the binding table and the entry type is static IPv6 source guard binding, dynamic ND snooping binding, or dynamic DHCPv6 snooping binding, the packet will be forwarded.
 - If IP source guard is enabled on an interface for which IPv6 source bindings (dynamically learned via ND snooping or DHCPv6 snooping, or manually configured) are not yet configured, the switch will drop all IPv6 traffic on that port, except for ND packets and DHCPv6 packets.
 - Only IPv6 global unicast addresses are accepted for static bindings.

PARAMETERS

These parameters are displayed:

- ◆ **Port** – Port identifier (Range: 1-28/52)

- ◆ **Filter Type** – Configures the switch to filter inbound traffic based on the following options. (Default: Disabled)
 - **Disabled** – Disables IPv6 source guard filtering on the port.
 - **SIP** – Enables traffic filtering based on IPv6 global unicast source IPv6 addresses stored in the binding table.

- ◆ **Max Binding Entry** – The maximum number of entries that can be bound to an interface. (Range: 1-5; Default: 5)
 - This parameter sets the maximum number of IPv6 global unicast source IPv6 address entries that can be mapped to an interface in the binding table, including both dynamic entries discovered by ND snooping, DHCPv6 snooping (see the [DHCPv6 Snooping](#) commands), and static entries set by IPv6 Source Guard (see ["Configuring Static Bindings for IPv6 Source Guard"](#) on page 409).
 - IPv6 source guard maximum bindings must be set to a value higher than DHCPv6 snooping maximum bindings and ND snooping maximum bindings.
 - If IPv6 source guard, ND snooping, and DHCPv6 snooping are enabled on a port, the dynamic bindings used by ND snooping, DHCPv6 snooping, and IPv6 source guard static bindings cannot exceed the maximum allowed bindings set by this parameter. In other words, no new entries will be added to the IPv6 source guard binding table.
 - If IPv6 source guard is enabled on a port, and the maximum number of allowed bindings is changed to a lower value, precedence is given to deleting entries learned through DHCPv6 snooping, ND snooping, and then manually configured IPv6 source guard static bindings, until the number of entries in the binding table reaches the newly configured maximum number of allowed bindings.

WEB INTERFACE

To set the IPv6 Source Guard filter for ports:

1. Click Security, IPv6 Source Guard, Port Configuration.
2. Set the required filtering type for each port.
3. Click Apply

Figure 220: Setting the Filter Type for IPv6 Source Guard

Interface	Filter Type	Max Binding Entry (1-5)
Eth 1/1	Disabled	5
Eth 1/2	Disabled	5
Eth 1/3	Disabled	5
Eth 1/4	Disabled	5
Eth 1/5	Disabled	5

CONFIGURING STATIC BINDINGS FOR IPv6 SOURCE GUARD

Use the Security > IPv6 Source Guard > Static Configuration page to bind a static address to a port. Table entries include a MAC address, IPv6 global unicast address, entry type (Static-IPv6-SG-Binding, Dynamic-ND-Binding, Dynamic-DHCPv6-Binding), VLAN identifier, and port identifier.

CLI REFERENCES

- ◆ ["ipv6 source-guard binding" on page 943](#)

COMMAND USAGE

- ◆ Traffic filtering is based only on the source IPv6 address, VLAN ID, and port number.
- ◆ Static addresses entered in the source guard binding table are automatically configured with an infinite lease time.
- ◆ When source guard is enabled, traffic is filtered based upon dynamic entries learned via ND snooping, DHCPv6 snooping, or static addresses configured in the source guard binding table.
- ◆ Static bindings are processed as follows:
 - If there is no entry with same MAC address and IPv6 address, a new entry is added to binding table using static IPv6 source guard binding.
 - If there is an entry with same MAC address and IPv6 address, and the type of entry is static IPv6 source guard binding, then the new entry will replace the old one.
 - If there is an entry with same MAC address and IPv6 address, and the type of the entry is either a dynamic ND snooping binding or DHCPv6 snooping binding, then the new entry will replace the old one and the entry type will be changed to static IPv6 source guard binding.
 - Only unicast addresses are accepted for static bindings.

PARAMETERS

These parameters are displayed:

Add

- ◆ **Port** – The port to which a static entry is bound.
- ◆ **VLAN** – ID of a configured VLAN (Range: 1-4094)
- ◆ **MAC Address** – A valid unicast MAC address.
- ◆ **IPv6 Address** – A valid global unicast IPv6 address. This address must be entered according to RFC 2373 "IPv6 Addressing Architecture," using 8 colon-separated 16-bit hexadecimal values. One double colon may be used in the address to indicate the appropriate number of zeros required to fill the undefined fields.

Show

- ◆ **VLAN** – VLAN to which this entry is bound.
- ◆ **MAC Address** – Physical address associated with the entry.
- ◆ **Interface** – The port to which this entry is bound.
- ◆ **IPv6 Address** – IPv6 address corresponding to the client.
- ◆ **Type** – Shows the entry type:
 - **DHCP** – Dynamic DHCPv6 binding, stateful address.
 - **ND** – Dynamic Neighbor Discovery binding, stateless address.
 - **STA** – Static IPv6 Source Guard binding.

WEB INTERFACE

To configure static bindings for IPv6 Source Guard:

1. Click Security, IPv6 Source Guard, Static Configuration.
2. Select Add from the Action list.
3. Enter the required bindings for each port.
4. Click Apply

Figure 221: Configuring Static Bindings for IPv6 Source Guard

Security > IPv6 Source Guard > Static Binding

Action: Add

Port: 1

VLAN: 1

MAC Address: 00-10-B5-F4-00-01

IPv6 Address: 2001::1

Apply Revert

To display static bindings for IPv6 Source Guard:

1. Click Security, IPv6 Source Guard, Static Configuration.
2. Select Show from the Action list.

Figure 222: Displaying Static Bindings for IPv6 Source Guard

Security > IPv6 Source Guard > Static Binding					
Action: <input type="button" value="Show"/>					
Static Binding List Total: 3					
<input type="checkbox"/>	VLAN	MAC Address	Interface	IPv6 Address	Type
<input type="checkbox"/>	1	00-10-B5-F4-00-01	Eth 1/2	2001:DB8:2222:7272::26	STA
<input type="checkbox"/>	1	00-10-B5-F4-00-02	Eth 1/4	2001:DB8:2222:7272::56	DHCP
<input type="checkbox"/>	2	00-10-B5-F4-00-03	Eth 1/7	2001:DB8:2222:7272::36	ND

**DISPLAYING
INFORMATION FOR
DYNAMIC IPv6
SOURCE GUARD
BINDINGS**

Use the Security > IPv6 Source Guard > Dynamic Binding page to display the source-guard binding table for a selected interface.

CLI REFERENCES

- ◆ "show ipv6 source-guard binding" on page 948

PARAMETERS

These parameters are displayed:

Query by

- ◆ **Port** – A port on this switch.
- ◆ **VLAN** – ID of a configured VLAN (Range: 1-4094)
- ◆ **MAC Address** – A valid unicast MAC address.
- ◆ **IPv6 Address** – A valid global unicast IPv6 address.

Dynamic Binding List

- ◆ **VLAN** – VLAN to which this entry is bound.
- ◆ **MAC Address** – Physical address associated with the entry.
- ◆ **Interface** – Port to which this entry is bound.
- ◆ **IPv6 Address** – IPv6 address corresponding to the client.
- ◆ **Type** – Shows the entry type:
 - **DHCP** – Dynamic DHCPv6 binding, stateful address.
 - **ND** – Dynamic Neighbor Discovery binding, stateless address.

WEB INTERFACE

To display the binding table for IPv6 Source Guard:

1. Click Security, IPv6 Source Guard, Dynamic Binding.
2. Mark the search criteria, and enter the required values.
3. Click Query

Figure 223: Showing the IPv6 Source Guard Binding Table

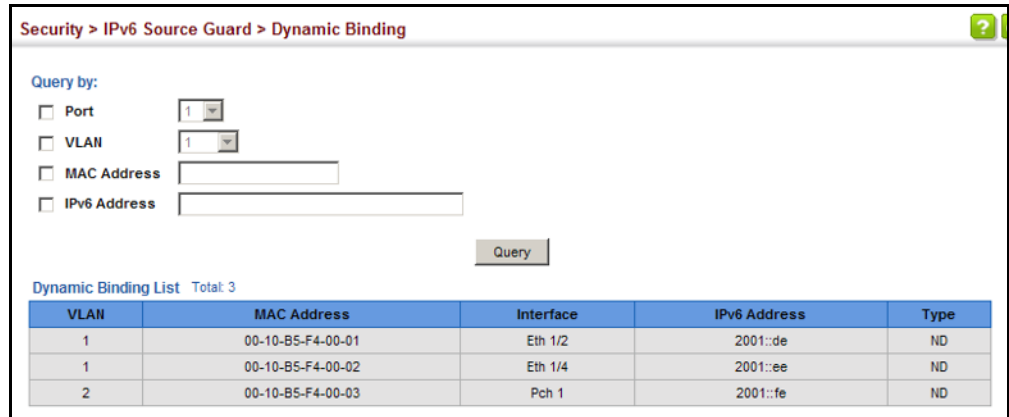

DHCP SNOOPING

The addresses assigned to DHCP clients on insecure ports can be carefully controlled using the dynamic bindings registered with DHCP Snooping (or using the static bindings configured with IP Source Guard). DHCP snooping allows a switch to protect a network from rogue DHCP servers or other devices which send port-related information to a DHCP server. This information can be useful in tracking an IP address back to a physical port.

COMMAND USAGE

DHCP Snooping Process

- ◆ Network traffic may be disrupted when malicious DHCP messages are received from an outside source. DHCP snooping is used to filter DHCP messages received on a non-secure interface from outside the network or fire wall. When DHCP snooping is enabled globally and enabled on a VLAN interface, DHCP messages received on an untrusted interface from a device not listed in the DHCP snooping table will be dropped.
- ◆ Table entries are only learned for trusted interfaces. An entry is added or removed dynamically to the DHCP snooping table when a client receives or releases an IP address from a DHCP server. Each entry includes a MAC address, IP address, lease time, VLAN identifier, and port identifier.

- ◆ The rate limit for the number of DHCP messages that can be processed by the switch is 100 packets per second. Any DHCP packets in excess of this limit are dropped.
- ◆ When DHCP snooping is enabled, DHCP messages entering an untrusted interface are filtered based upon dynamic entries learned via DHCP snooping.
- ◆ Filtering rules are implemented as follows:
 - If the global DHCP snooping is disabled, all DHCP packets are forwarded.
 - If DHCP snooping is enabled globally, and also enabled on the VLAN where the DHCP packet is received, all DHCP packets are forwarded for a *trusted* port. If the received packet is a DHCP ACK message, a dynamic DHCP snooping entry is also added to the binding table.
 - If DHCP snooping is enabled globally, and also enabled on the VLAN where the DHCP packet is received, but the port is *not trusted*, it is processed as follows:
 - If the DHCP packet is a reply packet from a DHCP server (including OFFER, ACK or NAK messages), the packet is dropped.
 - If the DHCP packet is from a client, such as a DECLINE or RELEASE message, the switch forwards the packet only if the corresponding entry is found in the binding table.
 - If the DHCP packet is from a client, such as a DISCOVER, REQUEST, INFORM, DECLINE or RELEASE message, the packet is forwarded if MAC address verification is disabled. However, if MAC address verification is enabled, then the packet will only be forwarded if the client's hardware address stored in the DHCP packet is the same as the source MAC address in the Ethernet header.
 - If the DHCP packet is not a recognizable type, it is dropped.
 - If a DHCP packet from a client passes the filtering criteria above, it will only be forwarded to trusted ports in the same VLAN.
 - If a DHCP packet is from server is received on a trusted port, it will be forwarded to both trusted and untrusted ports in the same VLAN.
 - If the DHCP snooping is globally disabled, all dynamic bindings are removed from the binding table.
 - *Additional considerations when the switch itself is a DHCP client* – The port(s) through which the switch submits a client request to the DHCP server must be configured as trusted. Note that the switch will not add a dynamic entry for itself to the binding table when it receives an ACK message from a DHCP server. Also, when the switch sends out DHCP client packets for itself, no filtering takes place. However, when the switch receives any messages from a

DHCP server, any packets received from untrusted ports are dropped.

DHCP Snooping Option 82

- ◆ DHCP provides a relay mechanism for sending information about its DHCP clients or the relay agent itself to the DHCP server. Also known as DHCP Option 82, it allows compatible DHCP servers to use the information when assigning IP addresses, or to set other services or policies for clients. It is also an effective tool in preventing malicious network attacks from attached clients on DHCP services, such as IP Spoofing, Client Identifier Spoofing, MAC Address Spoofing, and Address Exhaustion.
- ◆ DHCP Snooping must be enabled for Option 82 information to be inserted into request packets.
- ◆ When the DHCP Snooping Information Option 82 is enabled, the requesting client (or an intermediate relay agent that has used the information fields to describe itself) can be identified in the DHCP request packets forwarded by the switch and in reply packets sent back from the DHCP server. This information may specify the MAC address or IP address of the requesting device (that is, the switch in this context).
By default, the switch also fills in the Option 82 circuit-id field with information indicating the local interface over which the switch received the DHCP client request, including the port and VLAN ID. This allows DHCP client-server exchange messages to be forwarded between the server and client without having to flood them to the entire VLAN.
- ◆ If DHCP Snooping Information Option 82 is enabled on the switch, information may be inserted into a DHCP request packet received over any VLAN (depending on DHCP snooping filtering rules). The information inserted into the relayed packets includes the circuit-id and remote-id, as well as the gateway Internet address.
- ◆ When the switch receives DHCP packets from clients that already include DHCP Option 82 information, the switch can be configured to set the action policy for these packets. The switch can either drop the DHCP packets, keep the existing information, or replace it with the switch's relay information.

DHCP SNOOPING GLOBAL CONFIGURATION Use the IP Service > DHCP > Snooping (Configure Global) page to enable DHCP Snooping globally on the switch, or to configure MAC Address Verification.

CLI REFERENCES

- ◆ "DHCPv4 Snooping" on page 915

PARAMETERS

These parameters are displayed:

- ◆ **DHCP Snooping Status** – Enables DHCP snooping globally. (Default: Disabled)
- ◆ **DHCP Snooping MAC-Address Verification** – Enables or disables MAC address verification. If the source MAC address in the Ethernet header of the packet is not same as the client's hardware address in the DHCP packet, the packet is dropped. (Default: Enabled)
- ◆ **DHCP Snooping Information Option Status** – Enables or disables DHCP Option 82 information relay. (Default: Disabled)
- ◆ **DHCP Snooping Information Option Sub-option Format** – Enables or disables use of sub-type and sub-length fields in circuit-ID (CID) and remote-ID (RID) in Option 82 information.
- ◆ **DHCP Snooping Information Option Remote ID** – Specifies the MAC address, IP address, or arbitrary identifier of the requesting device (i.e., the switch in this context).
 - **MAC Address** – Inserts a MAC address in the remote ID sub-option for the DHCP snooping agent (i.e., the MAC address of the switch's CPU). This attribute can be encoded in Hexadecimal or ASCII.
 - **IP Address** – Inserts an IP address in the remote ID sub-option for the DHCP snooping agent (i.e., the IP address of the management interface). This attribute can be encoded in Hexadecimal or ASCII.
 - *string* – An arbitrary string inserted into the remote identifier field. (Range: 1-32 characters)
- ◆ **DHCP Snooping Information Option Policy** – Specifies how to handle DHCP client request packets which already contain Option 82 information.
 - **Drop** – Drops the client's request packet instead of relaying it.
 - **Keep** – Retains the Option 82 information in the client request, and forwards the packets to trusted ports.
 - **Replace** – Replaces the Option 82 information circuit-id and remote-id fields in the client's request with information about the relay agent itself, inserts the relay agent's address (when DHCP snooping is enabled), and forwards the packets to trusted ports. (This is the default policy.)

WEB INTERFACE

To configure global settings for DHCP Snooping:

1. Click IP Service, DHCP, Snooping.
2. Select Configure Global from the Step list.
3. Select the required options for the general DHCP snooping process and for the DHCP snooping information policy.
4. Click Apply

Figure 224: Configuring Global Settings for DHCP Snooping

The screenshot shows the configuration interface for DHCP Snooping. The breadcrumb is 'IP Service > DHCP > Snooping'. The 'Step' dropdown is set to '1. Configure Global'. The 'General' section includes 'DHCP Snooping Status' (disabled) and 'DHCP Snooping MAC-Address Verification' (enabled). The 'Information' section includes 'DHCP Snooping Information Option Status' (disabled), 'DHCP Snooping Information Option Sub-option Format' (Extra Subtype Included), 'DHCP Snooping Information Option Remote ID' (MAC Address (Hex Encoded)), and 'DHCP Snooping Information Option Policy' (Replace). 'Apply' and 'Revert' buttons are at the bottom.

DHCP SNOOPING VLAN CONFIGURATION

Use the IP Service > DHCP > Snooping (Configure VLAN) page to enable or disable DHCP snooping on specific VLANs.

CLI REFERENCES

- ◆ ["ip dhcp snooping vlan" on page 921](#)

COMMAND USAGE

- ◆ When DHCP snooping is enabled globally on the switch, and enabled on the specified VLAN, DHCP packet filtering will be performed on any untrusted ports within the VLAN.
- ◆ When the DHCP snooping is globally disabled, DHCP snooping can still be configured for specific VLANs, but the changes will not take effect until DHCP snooping is globally re-enabled.
- ◆ When DHCP snooping is globally enabled, and DHCP snooping is then disabled on a VLAN, all dynamic bindings learned for this VLAN are removed from the binding table.

PARAMETERS

These parameters are displayed:

- ◆ **VLAN** – ID of a configured VLAN. (Range: 1-4094)

- ◆ **DHCP Snooping Status** – Enables or disables DHCP snooping for the selected VLAN. When DHCP snooping is enabled globally on the switch, and enabled on the specified VLAN, DHCP packet filtering will be performed on any untrusted ports within the VLAN. (Default: Disabled)

WEB INTERFACE

To configure global settings for DHCP Snooping:

1. Click IP Service, DHCP, Snooping.
2. Select Configure VLAN from the Step list.
3. Enable DHCP Snooping on any existing VLAN.
4. Click Apply

Figure 225: Configuring DHCP Snooping on a VLAN



CONFIGURING PORTS FOR DHCP SNOOPING

Use the IP Service > DHCP > Snooping (Configure Interface) page to configure switch ports as trusted or untrusted.

CLI REFERENCES

- ◆ ["ip dhcp snooping trust" on page 923](#)

COMMAND USAGE

- ◆ A trusted interface is an interface that is configured to receive only messages from within the network. An untrusted interface is an interface that is configured to receive messages from outside the network or fire wall.
- ◆ When DHCP snooping is enabled both globally and on a VLAN, DHCP packet filtering will be performed on any untrusted ports within the VLAN.
- ◆ When an untrusted port is changed to a trusted port, all the dynamic DHCP snooping bindings associated with this port are removed.
- ◆ Set all ports connected to DHCP servers within the local network or fire wall to trusted state. Set all other ports outside the local network or fire wall to untrusted state.

PARAMETERS

These parameters are displayed:

- ◆ **Trust Status** – Enables or disables a port as trusted. (Default: Disabled)
- ◆ **Circuit ID** – Specifies DHCP Option 82 circuit ID suboption information.
 - **Mode** – Specifies the default string “VLAN-Unit-Port” or an arbitrary string. (Default: VLAN-Unit-Port)
 - **Value** – An arbitrary string inserted into the circuit identifier field. (Range: 1-32 characters)

WEB INTERFACE

To configure global settings for DHCP Snooping:

1. Click IP Service, DHCP, Snooping.
2. Select Configure Interface from the Step list.
3. Set any ports within the local network or firewall to trusted.
4. Specify the mode used for sending circuit ID information, and an arbitrary string if required.
5. Click Apply

Figure 226: Configuring the Port Mode for DHCP Snooping

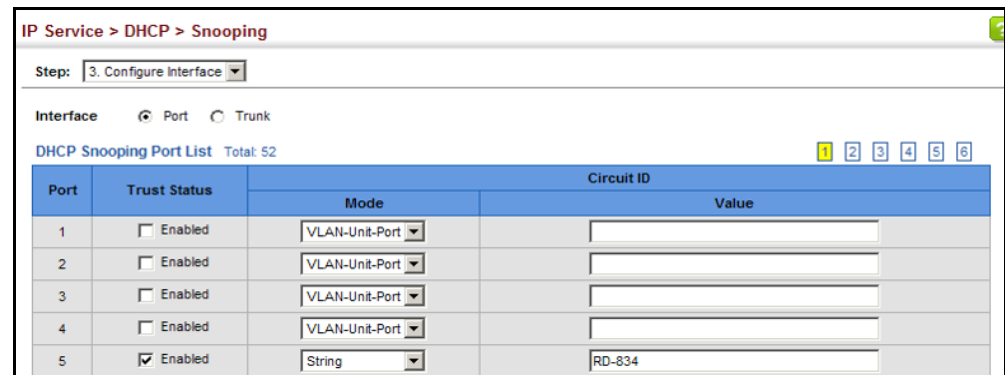

DISPLAYING DHCP SNOOPING BINDING INFORMATION

Use the IP Service > DHCP > Snooping (Show Information) page to display entries in the binding table.

CLI REFERENCES

- ◆ "show ip dhcp snooping binding" on page 926

PARAMETERS

These parameters are displayed:

- ◆ **MAC Address** – Physical address associated with the entry.
- ◆ **IP Address** – IP address corresponding to the client.
- ◆ **Lease Time** – The time for which this IP address is leased to the client.
- ◆ **Type** – Entry types include:
 - **DHCP-Snooping** – Dynamically snooped.
 - **Static-DHCPSNP** – Statically configured.
- ◆ **VLAN** – VLAN to which this entry is bound.
- ◆ **Interface** – Port or trunk to which this entry is bound.
- ◆ **Store** – Writes all dynamically learned snooping entries to flash memory. This function can be used to store the currently learned dynamic DHCP snooping entries to flash memory. These entries will be restored to the snooping table when the switch is reset. However, note that the lease time shown for a dynamic entry that has been restored from flash memory will no longer be valid.
- ◆ **Clear** – Removes all dynamically learned snooping entries from flash memory.

WEB INTERFACE

To display the binding table for DHCP Snooping:

1. Click IP Service, DHCP, Snooping.
2. Select Show Information from the Step list.
3. Use the Store or Clear function if required.

Figure 227: Displaying the Binding Table for DHCP Snooping

The screenshot shows a web interface for 'IP Service > DHCP > Snooping'. A dropdown menu is set to '4. Show Information'. Below this is a table titled 'DHCP Snooping Binding List' with a total of 6 entries. The table has the following data:

MAC Address	IP Address	Lease Time (seconds)	Type	VLAN	Interface
00-10-B5-F4-00-01	10.2.44.96	5	DHCP-Snooping	1	Trunk 1
00-10-B5-F4-00-02	10.3.44.96	15	Static-DHCPSNP	1	Unit 1 / Port 2
00-10-B5-F4-00-03	10.4.44.96	25	DHCP-Snooping	1	Unit 1 / Port 3
00-10-B5-F4-00-04	10.5.44.96	10	Static-DHCPSNP	1	Trunk 4
00-10-B5-F4-00-05	10.6.44.96	10	DHCP-Snooping	1	Unit 1 / Port 5
00-10-B5-F4-00-06	10.7.44.96	5	Static-DHCPSNP	1	Unit 1 / Port 6

Below the table are two buttons: 'Store' with the text 'Click the button to Store DHCP Snooping binding entries to flash.' and 'Clear' with the text 'Click the button to Clear DHCP Snooping binding entries from flash.'

This chapter describes basic administration tasks including:

- ◆ **Event Logging** – Sets conditions for logging event messages to system memory or flash memory, configures conditions for sending trap messages to remote log servers, and configures trap reporting to remote hosts using Simple Mail Transfer Protocol (SMTP).
- ◆ **Link Layer Discovery Protocol (LLDP)** – Configures advertisement of basic information about the local switch, or discovery of information about neighboring devices on the local broadcast domain.
- ◆ **Power over Ethernet⁸** – Sets the priority and power budget for each port.
- ◆ **Simple Network Management Protocol (SNMP)** – Configures switch management through SNMPv1, SNMPv2c or SNMPv3.
- ◆ **Remote Monitoring (RMON)** – Configures local collection of detailed statistics or events which can be subsequently retrieved through SNMP.
- ◆ **Switch Clustering** – Configures centralized management by a single unit over a group of switches connected to the same local network.
- ◆ **Ethernet Ring Protection Switching (ERPS)** – Configures a protection switching mechanism and protocol for Ethernet layer network rings.
- ◆ **Connectivity Fault Management (CFM)** – This protocol provides proactive connectivity monitoring using continuity check messages, fault verification through loop back messages, and fault isolation by examining end-to-end connections between provider edge devices or between customer edge devices.
- ◆ **Operation, Administration and Maintenance (OAM)** – Provides remote management tools required to monitor and maintain the links to subscriber CPEs (Customer Premise Equipment).

8. ECS4110-28P/52P

CONFIGURING EVENT LOGGING

The switch allows you to control the logging of error messages, including the type of events that are recorded in switch memory, logging to a remote System Log (syslog) server, and displays a list of recent event messages.

SYSTEM LOG CONFIGURATION

Use the Administration > Log > System (Configure Global) page to enable or disable event logging, and specify which levels are logged to RAM or flash memory.

Severe error messages that are logged to flash memory are permanently stored in the switch to assist in troubleshooting network problems. Up to 4096 log entries can be stored in the flash memory, with the oldest entries being overwritten first when the available log memory (256 kilobytes) has been exceeded.

The System Logs page allows you to configure and limit system messages that are logged to flash or RAM memory. The default is for event levels 0 to 3 to be logged to flash and levels 0 to 7 to be logged to RAM.

CLI REFERENCES

- ◆ ["Event Logging" on page 759](#)

PARAMETERS

These parameters are displayed:

- ◆ **System Log Status** – Enables/disables the logging of debug or error messages to the logging process. (Default: Enabled)
- ◆ **Flash Level** – Limits log messages saved to the switch's permanent flash memory for all levels up to the specified level. For example, if level 3 is specified, all messages from level 0 to level 3 will be logged to flash. (Range: 0-7, Default: 3)

Table 25: Logging Levels

Level	Severity Name	Description
7	Debug	Debugging messages
6	Informational	Informational messages only
5	Notice	Normal but significant condition, such as cold start
4	Warning	Warning conditions (e.g., return false, unexpected return)
3	Error	Error conditions (e.g., invalid input, default used)
2	Critical	Critical conditions (e.g., memory allocation, or free memory error - resource exhausted)
1	Alert	Immediate action needed
0	Emergency	System unusable

* There are only Level 2, 5 and 6 error messages for the current firmware release.

- ◆ **RAM Level** – Limits log messages saved to the switch’s temporary RAM memory for all levels up to the specified level. For example, if level 7 is specified, all messages from level 0 to level 7 will be logged to RAM. (Range: 0-7, Default: 7)



NOTE: The Flash Level must be equal to or less than the RAM Level.

NOTE: All log messages are retained in RAM and Flash after a warm restart (i.e., power is reset through the command interface).

NOTE: All log messages are retained in Flash and purged from RAM after a cold restart (i.e., power is turned off and then on through the power source).

WEB INTERFACE

To configure the logging of error messages to system memory:

1. Click Administration, Log, System.
2. Select Configure Global from the Step list.
3. Enable or disable system logging, set the level of event messages to be logged to flash memory and RAM.
4. Click Apply.

Figure 228: Configuring Settings for System Memory Logs

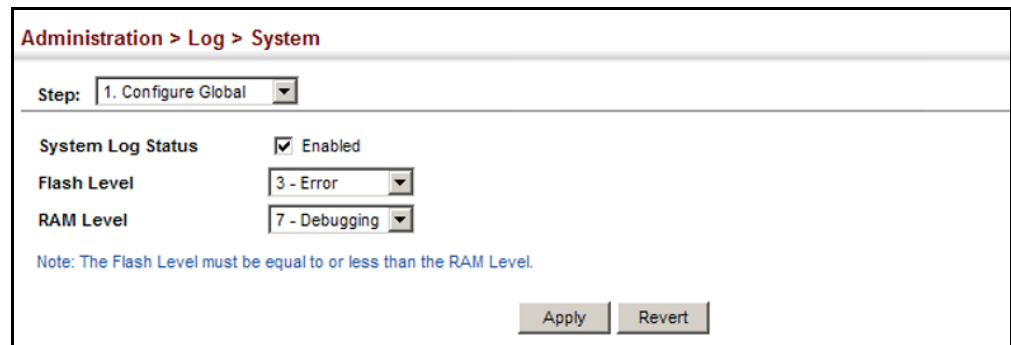

To show the error messages logged to system or flash memory:

1. Click Administration, Log, System.
2. Select Show System Logs from the Step list.
3. Click RAM to display log messages stored in system memory, or Flash to display messages stored in flash memory.

This page allows you to scroll through the logged system and event messages. The switch can store up to 2048 log entries in temporary random access memory (RAM; i.e., memory flushed on power reset) and up to 4096 entries in permanent flash memory.

Figure 229: Showing Error Messages Logged to System Memory

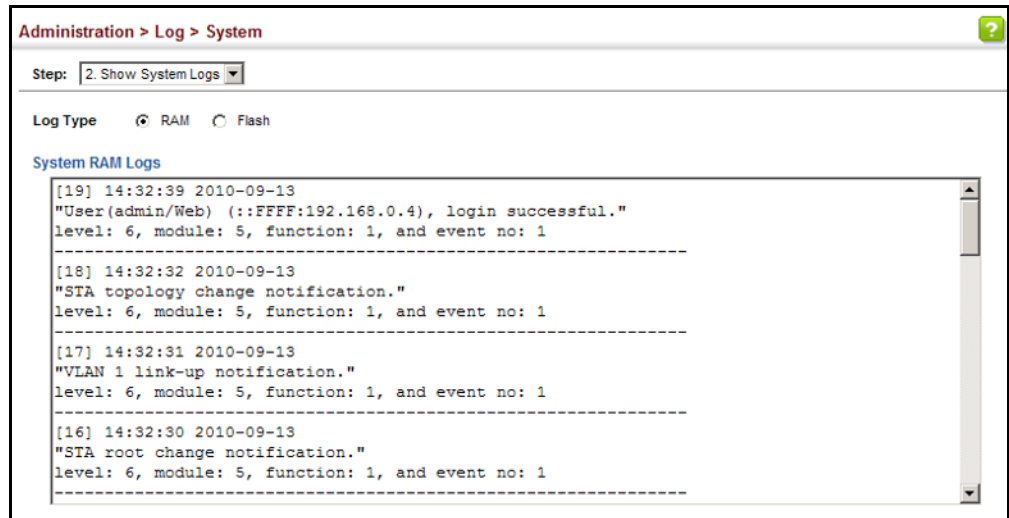

REMOTE LOG CONFIGURATION Use the Administration > Log > Remote page to send log messages to syslog servers or other management stations. You can also limit the event messages sent to only those messages below a specified level.

CLI REFERENCES

- ◆ "Event Logging" on page 759

PARAMETERS

These parameters are displayed:

- ◆ **Remote Log Status** – Enables/disables the logging of debug or error messages to the remote logging process. (Default: Disabled)
- ◆ **Logging Facility** – Sets the facility type for remote logging of syslog messages. There are eight facility types specified by values of 16 to 23. The facility type is used by the syslog server to dispatch log messages to an appropriate service.

The attribute specifies the facility type tag sent in syslog messages (see RFC 3164). This type has no effect on the kind of messages reported by the switch. However, it may be used by the syslog server to process messages, such as sorting or storing messages in the corresponding database. (Range: 16-23, Default: 23)
- ◆ **Logging Trap Level** – Limits log messages that are sent to the remote syslog server for all levels up to the specified level. For example, if level 3 is specified, all messages from level 0 to level 3 will be sent to the remote server. (Range: 0-7, Default: 7)
- ◆ **Server IP Address** – Specifies the IPv4 or IPv6 address of a remote server which will be sent syslog messages.
- ◆ **Port** – Specifies the UDP port number used by the remote server. (Range: 1-65535; Default: 514)

WEB INTERFACE

To configure the logging of error messages to remote servers:

1. Click Administration, Log, Remote.
2. Enable remote logging, specify the facility type to use for the syslog messages. and enter the IP address of the remote servers.
3. Click Apply.

Figure 230: Configuring Settings for Remote Logging of Error Messages

The screenshot shows the 'Administration > Log > Remote' configuration page. It includes the following fields and values:

- Remote Log Status: Enabled
- Logging Facility: 23 - Local use 7
- Logging Trap Level: 7 - Debugging messages
- Server IP Address 1: 192.168.0.4
- Port 1: 514
- Server IP Address 2: (empty)
- Port 2: (empty)
- Server IP Address 3: (empty)
- Port 3: (empty)
- Server IP Address 4: (empty)
- Port 4: (empty)
- Server IP Address 5: (empty)
- Port 5: (empty)

Buttons: Apply, Revert

SENDING SIMPLE MAIL TRANSFER PROTOCOL ALERTS

Use the Administration > Log > SMTP page to alert system administrators of problems by sending SMTP (Simple Mail Transfer Protocol) email messages when triggered by logging events of a specified level. The messages are sent to specified SMTP servers on the network and can be retrieved using POP or IMAP clients.

CLI REFERENCES

- ◆ "SMTP Alerts" on page 766

PARAMETERS

These parameters are displayed:

- ◆ **SMTP Status** – Enables/disables the SMTP function. (Default: Enabled)
- ◆ **Severity** – Sets the syslog severity threshold level (see table on page 422) used to trigger alert messages. All events at this level or higher will be sent to the configured email recipients. For example, using Level 7 will report all events from level 7 to level 0. (Default: Level 7)
- ◆ **Email Source Address** – Sets the email address used for the "From" field in alert messages. You may use a symbolic email address that identifies the switch, or the address of an administrator responsible for the switch. (Range: 1-41 characters)

- ◆ **Email Destination Address** – Specifies the email recipients of alert messages. You can specify up to five recipients.
- ◆ **Server IP Address** – Specifies a list of up to three recipient SMTP servers. IPv4 or IPv6 addresses may be specified. The switch attempts to connect to the listed servers in sequential order if the first server fails to respond.

For host name-to-IP address translation to function properly, host name lookup must be enabled (["Configuring General DNS Service Parameters" on page 663](#)), and one or more DNS servers specified (see ["Configuring a List of Name Servers" on page 666](#), or ["Configuring Static DNS Host to Address Entries" on page 667](#)).

WEB INTERFACE

To configure SMTP alert messages:

1. Click Administration, Log, SMTP.
2. Enable SMTP, specify a source email address, and select the minimum severity level. Specify the source and destination email addresses, and one or more SMTP servers.
3. Click Apply.

Figure 231: Configuring SMTP Alert Messages

Administration > Log > SMTP

SMTP Status	<input checked="" type="checkbox"/> Enabled
Severity	3 - Error
E-mail Source Address	big-wheels@matel.com
E-mail Destination Address 1	chris@matel.com
E-mail Destination Address 2	
E-mail Destination Address 3	
E-mail Destination Address 4	
E-mail Destination Address 5	
Server IP Address 1	192.168.1.4
Server IP Address 2	
Server IP Address 3	

Apply Revert

LINK LAYER DISCOVERY PROTOCOL

Link Layer Discovery Protocol (LLDP) is used to discover basic information about neighboring devices on the local broadcast domain. LLDP is a Layer 2 protocol that uses periodic broadcasts to advertise information about the sending device. Advertised information is represented in Type Length Value (TLV) format according to the IEEE 802.1AB standard, and can include details such as device identification, capabilities and configuration settings. LLDP also defines how to store and maintain information gathered about the neighboring network nodes it discovers.

Link Layer Discovery Protocol - Media Endpoint Discovery (LLDP-MED) is an extension of LLDP intended for managing endpoint devices such as Voice over IP phones and network switches. The LLDP-MED TLVs advertise information such as network policy, power, inventory, and device location details. LLDP and LLDP-MED information can be used by SNMP applications to simplify troubleshooting, enhance network management, and maintain an accurate network topology.

SETTING LLDP TIMING ATTRIBUTES

Use the Administration > LLDP (Configure Global) page to set attributes for general functions such as globally enabling LLDP on the switch, setting the message ageout time, and setting the frequency for broadcasting general advertisements or reports about changes in the LLDP MIB.

CLI REFERENCES

- ◆ ["LLDP Commands" on page 1323](#)

PARAMETERS

These parameters are displayed:

- ◆ **LLDP** – Enables LLDP globally on the switch. (Default: Enabled)
- ◆ **Transmission Interval** – Configures the periodic transmit interval for LLDP advertisements. (Range: 5-32768 seconds; Default: 30 seconds)
- ◆ **Hold Time Multiplier** – Configures the time-to-live (TTL) value sent in LLDP advertisements as shown in the formula below. (Range: 2-10; Default: 4)

The time-to-live tells the receiving LLDP agent how long to retain all information pertaining to the sending LLDP agent if it does not transmit updates in a timely manner.

TTL in seconds is based on the following rule:
minimum value ((Transmission Interval * Holdtime Multiplier), or 65535)

Therefore, the default TTL is $4 * 30 = 120$ seconds.

- ◆ **Delay Interval** – Configures a delay between the successive transmission of advertisements initiated by a change in local LLDP MIB variables. (Range: 1-8192 seconds; Default: 2 seconds)

The transmit delay is used to prevent a series of successive LLDP transmissions during a short period of rapid changes in local LLDP MIB

objects, and to increase the probability that multiple, rather than single changes, are reported in each transmission.

This attribute must comply with the rule:
 $(4 * \text{Delay Interval}) \leq \text{Transmission Interval}$

- ◆ **Reinitialization Delay** – Configures the delay before attempting to re-initialize after LLDP ports are disabled or the link goes down. (Range: 1-10 seconds; Default: 2 seconds)

When LLDP is re-initialized on a port, all information in the remote systems LLDP MIB associated with this port is deleted.

- ◆ **Notification Interval** – Configures the allowed interval for sending SNMP notifications about LLDP MIB changes. (Range: 5-3600 seconds; Default: 5 seconds)

This parameter only applies to SNMP applications which use data stored in the LLDP MIB for network monitoring or management.

Information about changes in LLDP neighbors that occur between SNMP notifications is not transmitted. Only state changes that exist at the time of a notification are included in the transmission. An SNMP agent should therefore periodically check the value of `IldpStatsRemTableLastChangeTime` to detect any `IldpRemTablesChange` notification-events missed due to throttling or transmission loss.

- ◆ **MED Fast Start Count** – Configures the amount of LLDP MED Fast Start LLDPDUs to transmit during the activation process of the LLDP-MED Fast Start mechanism. (Range: 1-10 packets; Default: 4 packets)

The MED Fast Start Count parameter is part of the timer which ensures that the LLDP-MED Fast Start mechanism is active for the port. LLDP-MED Fast Start is critical to the timely startup of LLDP, and therefore integral to the rapid availability of Emergency Call Service.

WEB INTERFACE

To configure LLDP timing attributes:

1. Click Administration, LLDP.
2. Select Configure Global from the Step list.
3. Enable LLDP, and modify any of the timing parameters as required.
4. Click Apply.

Figure 232: Configuring LLDP Timing Attributes

CONFIGURING LLDP INTERFACE ATTRIBUTES

Use the Administration > LLDP (Configure Interface – Configure General) page to specify the message attributes for individual interfaces, including whether messages are transmitted, received, or both transmitted and received, whether SNMP notifications are sent, and the type of information advertised.

CLI REFERENCES

- ◆ ["LLDP Commands" on page 1323](#)

PARAMETERS

These parameters are displayed:

- ◆ **Admin Status** – Enables LLDP message transmit and receive modes for LLDP Protocol Data Units. (Options: Tx only, Rx only, TxRx, Disabled; Default: TxRx)

- ◆ **SNMP Notification** – Enables the transmission of SNMP trap notifications about LLDP and LLDP-MED changes. (Default: Enabled)

This option sends out SNMP trap notifications to designated target stations at the interval specified by the Notification Interval in the preceding section. Trap notifications include information about state changes in the LLDP MIB (IEEE 802.1AB), the LLDP-MED MIB (ANSI/TIA-1057), or vendor-specific LLDP-EXT-DOT1 and LLDP-EXT-DOT3 MIBs.

For information on defining SNMP trap destinations, see ["Specifying Trap Managers" on page 472](#).

Information about additional changes in LLDP neighbors that occur between SNMP notifications is not transmitted. Only state changes that exist at the time of a trap notification are included in the transmission. An SNMP agent should therefore periodically check the value of `lldpStatsRemTableLastChangeTime` to detect any `lldpRemTablesChange` notification-events missed due to throttling or transmission loss.

- ◆ **MED Notification** – Enables the transmission of SNMP trap notifications about LLDP-MED changes. (Default: Disabled)
- ◆ **Basic Optional TLVs** – Configures basic information included in the TLV field of advertised messages.
 - **Management Address** – The management address protocol packet includes the IPv4 address of the switch. If no management address is available, the address should be the MAC address for the CPU or for the port sending this advertisement.

The management address TLV may also include information about the specific interface associated with this address, and an object identifier indicating the type of hardware component or protocol entity associated with this address. The interface number and OID are included to assist SNMP applications in the performance of network discovery by indicating enterprise specific or other starting points for the search, such as the Interface or Entity MIB.

Since there are typically a number of different addresses associated with a Layer 3 device, an individual LLDP PDU may contain more than one management address TLV.

Every management address TLV that reports an address that is accessible on a port and protocol VLAN through the particular port should be accompanied by a port and protocol VLAN TLV that indicates the VLAN identifier (VID) associated with the management address reported by this TLV.
 - **Port Description** – The port description is taken from the ifDescr object in RFC 2863, which includes information about the manufacturer, the product name, and the version of the interface hardware/software.
 - **System Capabilities** – The system capabilities identifies the primary function(s) of the system and whether or not these primary functions are enabled. The information advertised by this TLV is described in IEEE 802.1AB.
 - **System Description** – The system description is taken from the sysDescr object in RFC 3418, which includes the full name and version identification of the system's hardware type, software operating system, and networking software.
 - **System Name** – The system name is taken from the sysName object in RFC 3418, which contains the system's administratively assigned name. To configure the system name, see ["Displaying System Information" on page 123](#).
- ◆ **802.1 Organizationally Specific TLVs** – Configures IEEE 802.1 information included in the TLV field of advertised messages.
 - **Protocol Identity** – The protocols that are accessible through this interface (see ["Protocol VLANs" on page 220](#)).

- **VLAN ID** – The port’s default VLAN identifier (PVID) indicates the VLAN with which untagged or priority-tagged frames are associated (see ["IEEE 802.1Q VLANs" on page 199](#)).
 - **VLAN Name** – The name of all VLANs to which this interface has been assigned (see ["IEEE 802.1Q VLANs" on page 199](#)).
 - **Port and Protocol VLAN ID** – The port-based protocol VLANs configured on this interface (see ["Protocol VLANs" on page 220](#)).
- ◆ **802.3 Organizationally Specific TLVs** – Configures IEEE 802.3 information included in the TLV field of advertised messages.
- **Link Aggregation** – The link aggregation capabilities, aggregation status of the link, and the IEEE 802.3 aggregated port identifier if this interface is currently a link aggregation member.
 - **Max Frame Size** – The maximum frame size. (See ["Configuring Support for Jumbo Frames" on page 126](#) for information on configuring the maximum frame size for this switch
 - **PoE⁹** – Power-over-Ethernet capabilities, including whether or not PoE is supported, currently enabled, if the port pins through which power is delivered can be controlled, the port pins selected to deliver power, and the power class.
 - **MAC/PHY Configuration/Status** – The MAC/PHY configuration and status which includes information about auto-negotiation support/capabilities, and operational Multistation Access Unit (MAU) type.
- ◆ **MED TLVs** – Configures general information included in the MED TLV field of advertised messages.
- **Capabilities** – This option advertises LLDP-MED TLV capabilities, allowing Media Endpoint and Connectivity Devices to efficiently discover which LLDP-MED related TLVs are supported on the switch.
 - **Extended Power⁹** – This option advertises extended Power-over-Ethernet capability details, such as power availability from the switch, and power state of the switch, including whether the switch is operating from primary or backup power (the Endpoint Device could use this information to decide to enter power conservation mode).
 - **Inventory** – This option advertises device details useful for inventory management, such as manufacturer, model, software version and other pertinent information.
 - **Location** – This option advertises location identification details.
 - **Network Policy** – This option advertises network policy configuration information, aiding in the discovery and diagnosis of

9. ES4110-28P/52P

VLAN configuration mismatches on a port. Improper network policy configurations frequently result in voice quality degradation or complete service disruption.

- ◆ **MED-Location Civic Address** – Configures information for the location of the attached device included in the MED TLV field of advertised messages, including the country and the device type.
 - **Country** – The two-letter ISO 3166 country code in capital ASCII letters. (Example: DK, DE or US)
 - **Device entry refers to** – The type of device to which the location applies:
 - Location of DHCP server.
 - Location of network element closest to client.
 - Location of client. (This is the default.)

WEB INTERFACE

To configure LLDP interface attributes:

1. Click Administration, LLDP.
2. Select Configure Interface from the Step list.
3. Select Configure General from the Action list.
4. Select an interface from the Port or Trunk list.
5. Set the LLDP transmit/receive mode, specify whether or not to send SNMP trap messages, and select the information to advertise in LLDP messages.
6. Click Apply.

Figure 233: Configuring LLDP Interface Attributes

The screenshot shows the 'Administration > LLDP' configuration page. At the top, it indicates 'Step: 2. Configure Interface' and 'Action: Configure General'. The interface is set to 'Port 1'. Under 'Admin Status', 'Tx Rx' is selected. 'SNMP Notification' is checked and 'MED Notification' is unchecked. There are sections for 'Basic Optional TLVs', '802.1 Organizationally Specific TLVs', '802.3 Organizationally Specific TLVs', and 'MED TLVs', each with several checkboxes. The 'MED-Location Civic Address' section is expanded, showing 'Country' as 'US' and 'Device entry refers to' as 'Location of the client'. A note at the bottom states: 'Note: The country string shall be a two-letter ISO 3166 country code, e.g. US'. 'Apply' and 'Revert' buttons are at the bottom right.

CONFIGURING LLDP INTERFACE CIVIC-ADDRESS

Use the Administration > LLDP (Configure Interface – Add CA-Type) page to specify the physical location of the device attached to an interface.

CLI REFERENCES

- ◆ "lldp med-location civic-addr" on page 1336

COMMAND USAGE

- ◆ Use the Civic Address type (CA-Type) to advertise the physical location of the device attached to an interface, including items such as the city, street number, building and room information. The address location is specified as a type and value pair, with the civic address type defined in RFC 4776. The following table describes some of the CA type numbers and provides examples.

Table 26: LLDP MED Location CA Types

CA Type	Description	CA Value Example
1	National subdivisions (state, canton, province)	California
2	County, parish	Orange
3	City, township	Irvine
4	City division, borough, city district	West Irvine
5	Neighborhood, block	Riverside
6	Group of streets below the neighborhood level	Exchange

Table 26: LLDP MED Location CA Types (Continued)

CA Type	Description	CA Value Example
18	Street suffix or type	Avenue
19	House number	320
20	House number suffix	A
21	Landmark or vanity address	Tech Center
26	Unit (apartment, suite)	Apt 519
27	Floor	5
28	Room	509B

- ◆ Any number of CA type and value pairs can be specified for the civic address location, as long as the total does not exceed 250 characters.

PARAMETERS

These parameters are displayed:

- ◆ **CA-Type** – Descriptor of the data civic address value. (Range: 0-255)
- ◆ **CA-Value** – Description of a location. (Range: 1-32 characters)

WEB INTERFACE

To specify the physical location of the attached device:

1. Click Administration, LLDP.
2. Select Configure Interface from the Step list.
3. Select Add CA-Type from the Action list.
4. Select an interface from the Port or Trunk list.
5. Specify a CA-Type and CA-Value pair.
6. Click Apply.

Figure 234: Configuring the Civic Address for an LLDP Interface

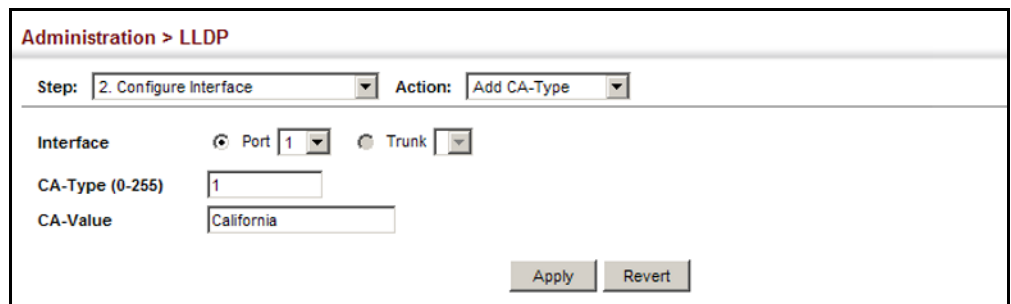

To show the physical location of the attached device:

1. Click Administration, LLDP.
2. Select Configure Interface from the Step list.
3. Select Show CA-Type from the Action list.
4. Select an interface from the Port or Trunk list.

Figure 235: Showing the Civic Address for an LLDP Interface

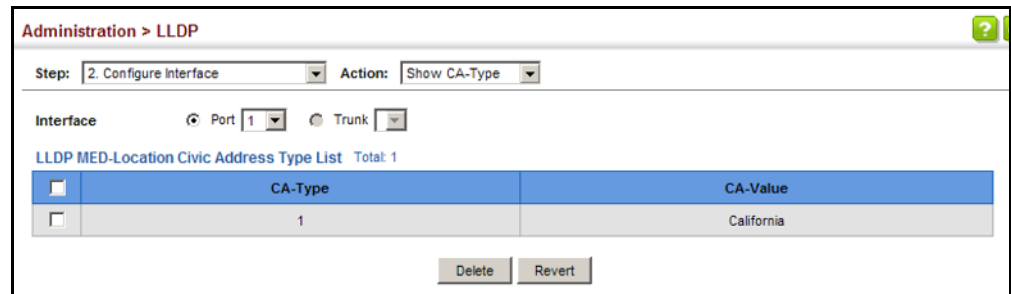

DISPLAYING LLDP LOCAL DEVICE INFORMATION

Use the Administration > LLDP (Show Local Device Information) page to display information about the switch, such as its MAC address, chassis ID, management IP address, and port information.

CLI REFERENCES

- ◆ "show lldp info local-device" on page 1343

PARAMETERS

These parameters are displayed:

Global Settings

- ◆ **Chassis Type** – Identifies the chassis containing the IEEE 802 LAN entity associated with the transmitting LLDP agent. There are several ways in which a chassis may be identified and a chassis ID subtype is used to indicate the type of component being referenced by the chassis ID field.

Table 27: Chassis ID Subtype

ID Basis	Reference
Chassis component	EntPhysicalAlias when entPhysClass has a value of 'chassis(3)' (IETF RFC 2737)
Interface alias	IfAlias (IETF RFC 2863)
Port component	EntPhysicalAlias when entPhysicalClass has a value 'port(10)' or 'backplane(4)' (IETF RFC 2737)
MAC address	MAC address (IEEE Std 802-2001)
Network address	networkAddress

Table 27: Chassis ID Subtype (Continued)

ID Basis	Reference
Interface name	ifName (IETF RFC 2863)
Locally assigned	locally assigned

- ◆ **Chassis ID** – An octet string indicating the specific identifier for the particular chassis in this system.
- ◆ **System Name** – A string that indicates the system’s administratively assigned name (see ["Displaying System Information" on page 123](#)).
- ◆ **System Description** – A textual description of the network entity. This field is also displayed by the **show system** command.
- ◆ **System Capabilities Supported** – The capabilities that define the primary function(s) of the system.

Table 28: System Capabilities

ID Basis	Reference
Other	—
Repeater	IETF RFC 2108
Bridge	IETF RFC 2674
WLAN Access Point	IEEE 802.11 MIB
Router	IETF RFC 1812
Telephone	IETF RFC 2011
DOCSIS cable device	IETF RFC 2669 and IETF RFC 2670
End Station Only	IETF RFC 2011

- ◆ **System Capabilities Enabled** – The primary function(s) of the system which are currently enabled. Refer to the preceding table.
- ◆ **Management Address** – The management address associated with the local system. If no management address is available, the address should be the MAC address for the CPU or for the port sending this advertisement.

Interface Settings

The attributes listed below apply to both port and trunk interface types. When a trunk is listed, the descriptions apply to the first port of the trunk.

- ◆ **Port/Trunk Description** – A string that indicates the port or trunk description. If RFC 2863 is implemented, the ifDescr object should be used for this field.
- ◆ **Port/Trunk ID** – A string that contains the specific identifier for the port or trunk from which this LLDPDU was transmitted.

Interface Details

The attributes listed below apply to both port and trunk interface types. When a trunk is listed, the descriptions apply to the first port of the trunk.

- ◆ **Local Port/Trunk** – Local interface on this switch.
- ◆ **Port/Trunk ID Type** – There are several ways in which a port may be identified. A port ID subtype is used to indicate how the port is being referenced in the Port ID TLV.

Table 29: Port ID Subtype

ID Basis	Reference
Interface alias	IfAlias (IETF RFC 2863)
Port component	EntPhysicalAlias when entPhysicalClass has a value 'port(10)' or 'backplane(4)' (IETF RFC 4133)
MAC address	MAC address (IEEE Std 802-2001)
Network address	networkAddress
Interface name	ifName (IETF RFC 2863)
Agent circuit ID	agent circuit ID (IETF RFC 3046)
Locally assigned	locally assigned

- ◆ **Port/Trunk ID** – A string that contains the specific identifier for the local interface based on interface subtype used by this switch.
- ◆ **Port/Trunk Description** – A string that indicates the port or trunk description. If RFC 2863 is implemented, the ifDescr object should be used for this field.
- ◆ **MED Capability** – The supported set of capabilities that define the primary function(s) of the interface:
 - LLDP-MED Capabilities
 - Network Policy
 - Location Identification
 - Extended Power via MDI – PSE
 - Extended Power via MDI – PD
 - Inventory

WEB INTERFACE

To display LLDP information for the local device:

1. Click Administration, LLDP.
2. Select Show Local Device Information from the Step list.
3. Select General, Port, Port Details, Trunk, or Trunk Details.

Figure 236: Displaying Local Device Information for LLDP (General)

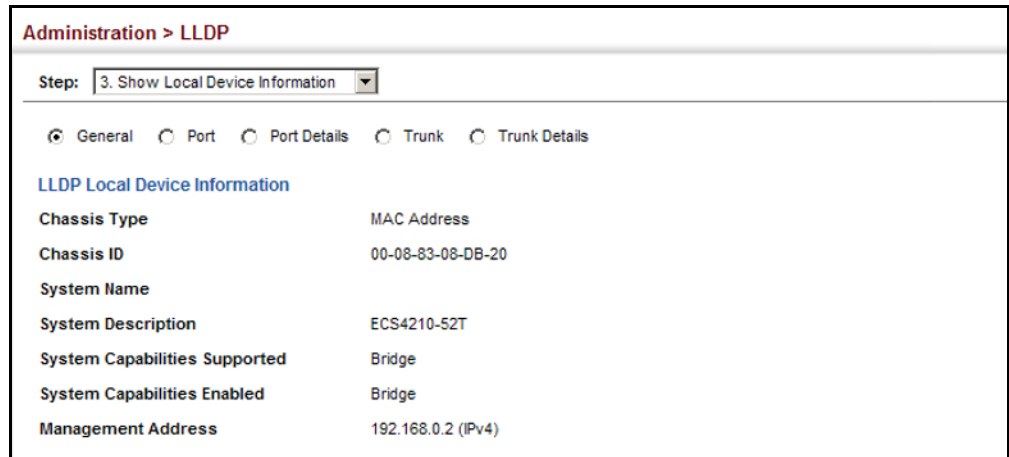

Figure 237: Displaying Local Device Information for LLDP (Port)

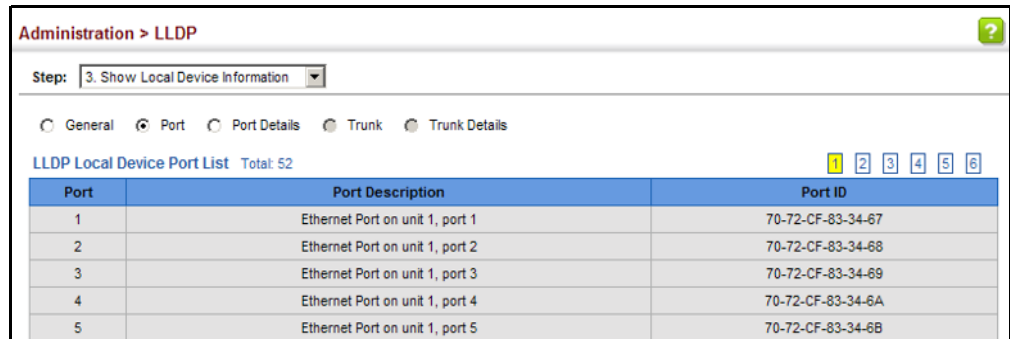
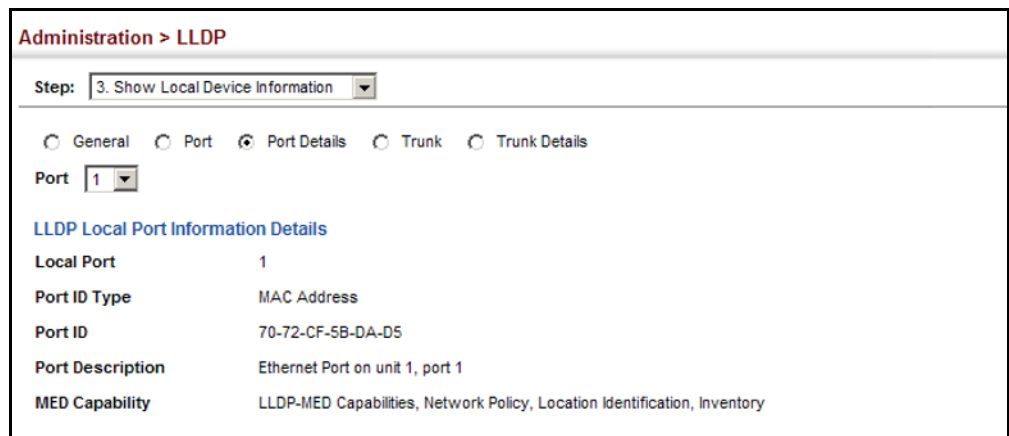

Figure 238: Displaying Local Device Information for LLDP (Port Details)



**DISPLAYING LLDP
REMOTE DEVICE
INFORMATION**

Use the Administration > LLDP (Show Remote Device Information) page to display information about devices connected directly to the switch’s ports which are advertising information through LLDP, or to display detailed information about an LLDP-enabled device connected to a specific port on the local switch.

CLI REFERENCES

- ◆ ["show lldp info remote-device" on page 1344](#)

PARAMETERS

These parameters are displayed:

Port

- ◆ **Local Port** – The local port to which a remote LLDP-capable device is attached.
- ◆ **Chassis ID** – An octet string indicating the specific identifier for the particular chassis in this system.
- ◆ **Port ID** – A string that contains the specific identifier for the port from which this LLDPDU was transmitted.
- ◆ **System Name** – A string that indicates the system’s administratively assigned name.

Port Details

- ◆ **Port** – Port identifier on local switch.
- ◆ **Remote Index** – Index of remote device attached to this port.
- ◆ **Local Port** – The local port to which a remote LLDP-capable device is attached.
- ◆ **Chassis Type** – Identifies the chassis containing the IEEE 802 LAN entity associated with the transmitting LLDP agent. There are several ways in which a chassis may be identified and a chassis ID subtype is used to indicate the type of component being referenced by the chassis ID field. (See [Table 27, "Chassis ID Subtype," on page 435.](#))
- ◆ **Chassis ID** – An octet string indicating the specific identifier for the particular chassis in this system.
- ◆ **System Name** – A string that indicates the system’s assigned name.
- ◆ **System Description** – A textual description of the network entity.
- ◆ **Port Type** – Indicates the basis for the identifier that is listed in the Port ID field. (See [Table 29, "Port ID Subtype," on page 437.](#))
- ◆ **Port Description** – A string that indicates the port’s description. If RFC 2863 is implemented, the ifDescr object should be used for this field.
- ◆ **Port ID** – A string that contains the specific identifier for the port from which this LLDPDU was transmitted.
- ◆ **System Capabilities Supported** – The capabilities that define the primary function(s) of the system. (See [Table 28, "System Capabilities," on page 436.](#))

- ◆ **System Capabilities Enabled** – The primary function(s) of the system which are currently enabled. (See [Table 28, "System Capabilities,"](#) on page 436.)
- ◆ **Management Address List** – The management addresses for this device. Since there are typically a number of different addresses associated with a Layer 3 device, an individual LLDP PDU may contain more than one management address TLV.

If no management address is available, the address should be the MAC address for the CPU or for the port sending this advertisement.

Port Details – 802.1 Extension Information

- ◆ **Remote Port VID** – The port’s default VLAN identifier (PVID) indicates the VLAN with which untagged or priority-tagged frames are associated.
- ◆ **Remote Port-Protocol VLAN List** – The port-based protocol VLANs configured on this interface, whether the given port (associated with the remote system) supports port-based protocol VLANs, and whether the port-based protocol VLANs are enabled on the given port associated with the remote system.
- ◆ **Remote VLAN Name List** – VLAN names associated with a port.
- ◆ **Remote Protocol Identity List** – Information about particular protocols that are accessible through a port. This object represents an arbitrary local integer value used by this agent to identify a particular protocol identity, and an octet string used to identify the protocols associated with a port of the remote system.

Port Details – 802.3 Extension Port Information

- ◆ **Remote Port Auto-Neg Supported** – Shows whether the given port (associated with remote system) supports auto-negotiation.
- ◆ **Remote Port Auto-Neg Adv-Capability** – The value (bitmap) of the ifMauAutoNegCapAdvertisedBits object (defined in IETF RFC 3636) which is associated with a port on the remote system.

Table 30: Remote Port Auto-Negotiation Advertised Capability

Bit	Capability
0	other or unknown
1	10BASE-T half duplex mode
2	10BASE-T full duplex mode
3	100BASE-T4
4	100BASE-TX half duplex mode
5	100BASE-TX full duplex mode
6	100BASE-T2 half duplex mode
7	100BASE-T2 full duplex mode

Table 30: Remote Port Auto-Negotiation Advertised Capability

Bit	Capability
8	PAUSE for full-duplex links
9	Asymmetric PAUSE for full-duplex links
10	Symmetric PAUSE for full-duplex links
11	Asymmetric and Symmetric PAUSE for full-duplex links
12	1000BASE-X, -LX, -SX, -CX half duplex mode
13	1000BASE-X, -LX, -SX, -CX full duplex mode
14	1000BASE-T half duplex mode
15	1000BASE-T full duplex mode

- ◆ **Remote Port Auto-Neg Status** – Shows whether port auto-negotiation is enabled on a port associated with the remote system.
- ◆ **Remote Port MAU Type** – An integer value that indicates the operational MAU type of the sending device. This object contains the integer value derived from the list position of the corresponding dot3MauType as listed in IETF RFC 3636 and is equal to the last number in the respective dot3MauType OID.

Port Details – 802.3 Extension Power Information

- ◆ **Remote Power Class** – The port Class of the given port associated with the remote system (PSE – Power Sourcing Equipment or PD – Powered Device).
- ◆ **Remote Power MDI Status** – Shows whether MDI power is enabled on the given port associated with the remote system.
- ◆ **Remote Power Pairs** – “Signal” means that the signal pairs only are in use, and “Spare” means that the spare pairs only are in use.
- ◆ **Remote Power MDI Supported** – Shows whether MDI power is supported on the given port associated with the remote system.
- ◆ **Remote Power Pair Controllable** – Indicates whether the pair selection can be controlled for sourcing power on the given port associated with the remote system.
- ◆ **Remote Power Classification** – This classification is used to tag different terminals on the Power over LAN network according to their power consumption. Devices such as IP telephones, WLAN access points and others, will be classified according to their power requirements.

Port Details – 802.3 Extension Trunk Information

- ◆ **Remote Link Aggregation Capable** – Shows if the remote port is not in link aggregation state and/or it does not support link aggregation.

- ◆ **Remote Link Aggregation Status** – The current aggregation status of the link.
- ◆ **Remote Link Port ID** – This object contains the IEEE 802.3 aggregated port identifier, aAggPortID (IEEE 802.3-2002, 30.7.2.1.1), derived from the ifNumber of the ifIndex for the port component associated with the remote system. If the remote port is not in link aggregation state and/or it does not support link aggregation, this value should be zero.

Port Details – 802.3 Extension Frame Information

- ◆ **Remote Max Frame Size** – An integer value indicating the maximum supported frame size in octets on the port component associated with the remote system.

Port Details – LLDP-MED Capability ¹⁰

- ◆ **Device Class** – Any of the following categories of endpoint devices:
 - Class 1 – The most basic class of endpoint devices.
 - Class 2 – Endpoint devices that supports media stream capabilities.
 - Class 3 – Endpoint devices that directly supports end users of the IP communication systems.
 - Network Connectivity Device – Devices that provide access to the IEEE 802 based LAN infrastructure for LLDP-MED endpoint devices. These may be any LAN access device including LAN switch/router, IEEE 802.1 bridge, IEEE 802.3 repeater, IEEE 802.11 wireless access point, or any device that supports the IEEE 802.1AB and MED extensions defined by this Standard and can relay IEEE 802 frames via any method.
- ◆ **Supported Capabilities** – The supported set of capabilities that define the primary function(s) of the port:
 - LLDP-MED Capabilities
 - Network Policy
 - Location Identification
 - Extended Power via MDI – PSE
 - Extended Power via MDI – PD
 - Inventory
- ◆ **Current Capabilities** – The set of capabilities that define the primary function(s) of the port which are currently enabled.

10. These fields are only displayed for end-node devices advertising LLDP-MED TLVs.

Port Details – Network Policy¹⁰

- ◆ **Application Type** – The primary application(s) defined for this network policy:
 - Voice
 - Voice Signaling
 - Guest Signaling
 - Guest Voice Signaling
 - Softphone Voice
 - Video Conferencing
 - Streaming Video
 - Video Signaling
- ◆ **Tagged Flag** – Indicates whether the specified application type is using a tagged or untagged VLAN.
- ◆ **Layer 2 Priority** – The Layer 2 priority to be used for the specified application type. This field may specify one of eight priority levels (0-7), where a value of 0 represents use of the default priority.
- ◆ **Unknown Policy Flag** – Indicates that an endpoint device wants to explicitly advertise that this policy is required by the device, but is currently unknown.
- ◆ **VLAN ID** – The VLAN identifier (VID) for the port as defined in IEEE 802.1Q. A value of zero indicates that the port is using priority tagged frames, meaning that only the IEEE 802.1D priority level is significant and the default PVID of the ingress port is used instead.
- ◆ **DSCP Value** – The DSCP value to be used to provide Diffserv node behavior for the specified application type. This field may contain one of 64 code point values (0-63). A value of 0 represents use of the default DSCP value as defined in RFC 2475.

Port Details – Location Identification¹⁰

- ◆ **Location Data Format** – Any of these location ID data formats:
 - Coordinate-based LCI¹¹ – Defined in RFC 3825, includes latitude resolution, latitude, longitude resolution, longitude, altitude type, altitude resolution, altitude, and datum.
 - Civic Address LCI¹¹ – Includes What, Country code, CA type, CA length and CA value. “What” is described as the field entry “Device entry refers to” under [“Configuring LLDP Interface Attributes.”](#) The other items and described under [“Configuring LLDP Interface Civic-Address.”](#)

11. Location Configuration Information

- ECS ELIN – Emergency Call Service Emergency Location Identification Number supports traditional PSAP-based Emergency Call Service in North America.
- ◆ **Country Code** – The two-letter ISO 3166 country code in capital ASCII letters. (Example: DK, DE or US)
- ◆ **What** – The type of device to which the location applies as described for the field entry “Device entry refers to” under “[Configuring LLDP Interface Attributes](#).”

Port Details – Inventory¹⁰

- ◆ **Hardware Revision** – The hardware revision of the end-point device.
- ◆ **Software Revision** – The software revision of the end-point device.
- ◆ **Manufacture Name** – The manufacturer of the end-point device.
- ◆ **Asset ID** – The asset identifier of the end-point device. End-point devices are typically assigned asset identifiers to facilitate inventory management and assets tracking.
- ◆ **Firmware Revision** – The firmware revision of the end-point device.
- ◆ **Serial Number** – The serial number of the end-point device.
- ◆ **Model Name** – The model name of the end-point device.

WEB INTERFACE

To display LLDP information for a remote port:

1. Click Administration, LLDP.
2. Select Show Remote Device Information from the Step list.
3. Select Port, Port Details, Trunk, or Trunk Details.
4. When the next page opens, select a port on this switch and the index for a remote device attached to this port.
5. Click Query.

Figure 239: Displaying Remote Device Information for LLDP (Port)

Local Port	Chassis ID	Port ID	System Name
1	70-72-CF-32-DD-FD	70-72-CF-32-DD-FF	RD93

Administration > LLDP

Step: 4. Show Remote Device Information

Port
 Port Details
 Trunk
 Trunk Details

Port: 1

Remote Index: 2

Query

Figure 240: Displaying Remote Device Information for LLDP (Port Details)

Administration > LLDP

Step: 4. Show Remote Device Information

Port
 Port Details
 Trunk
 Trunk Details

Port: 2

LLDP Remote Device Port Information

Local Port	2	Port Type	MAC Address
Chassis Type	MAC Address	Port Description	Ethernet Port on unit 1, port 1
Chassis ID	00-E0-0C-00-00-FE	Port ID	00-E0-0C-00-00-FF
System Name		System Capabilities Supported	Bridge
System Description		System Capabilities Enabled	Bridge

Management Address List Total: 1

Address	Address Type
192.168.0.3	IPv4 Address

802.1 Extension Information

Remote Port VID: 1

Remote Port-Protocol VLAN List Total: 1

VLAN	Support	Status
3	Yes	Enabled

Remote VLAN Name List Total: 3

VLAN	Name
1	DefaultVlan
2	R&D
3	Protocol

Remote Protocol Identity List Total: 1

Remote Protocol Identity
88-CC

802.3 Extension Port Information

Remote Port Auto-Neg Supported	Yes	Remote Port Auto-Neg Status	Enabled
Remote Port Auto-Neg Adv-Capability	0000	Remote Port MAU Type	6

802.3 Extension Power Information

Remote Power Class	PSE	Remote Power MDI Supported	Yes
Remote Power MDI Status	Enabled	Remote Power Pair Controlable	No
Remote Power Pairs	Spare	Remote Power Classification	Class1

802.3 Extension Trunk Information

Remote Link Aggregation Capable	Yes	Remote Link Aggregation Status	Disabled
Remote Link Port ID	0		

802.3 Extension Frame Information

Remote Max Frame Size	1518
-----------------------	------

Additional information displayed by an end-point device which advertises LLDP-MED TLVs is shown in the following figure.

Figure 241: Displaying Remote Device Information for LLDP (End Node)

Administration > LLDP			
Step: 4. Show Remote Device Information			
LLDP-MED Capability			
Device Class	Network Connectivity		
Supported Capabilities	LLDP-MED Capabilities, Network Policy, Location Identification, Inventory		
Current Capabilities	LLDP-MED Capabilities, Network Policy, Location Identification, Inventory		
Network Policy			
Application Type	Guest Voice Signaling	Unknown Policy Flag	Disabled
Tagged Flag	Disabled	VLAN ID	7
Layer 2 Priority	2	DSCP Value	62
Location Identification			
Location Data Format	Coordinate-based LCI		
Country Code	TW	What	2
Inventory			
Hardware Revision	R01	Firmware Revision	1.0.0.2
Software Revision	1.0.0.2	Serial Number	LN11360051
Manufacture Name		Model Name	
Asset ID	1		

DISPLAYING DEVICE STATISTICS

Use the Administration > LLDP (Show Device Statistics) page to display statistics for LLDP-capable devices attached to the switch, and for LLDP protocol messages transmitted or received on all local interfaces.

CLI REFERENCES

- ◆ "show lldp info statistics" on page 1346

PARAMETERS

These parameters are displayed:

General Statistics on Remote Devices

- ◆ **Neighbor Entries List Last Updated** – The time the LLDP neighbor entry list was last updated.
- ◆ **New Neighbor Entries Count** – The number of LLDP neighbors for which the remote TTL has not yet expired.
- ◆ **Neighbor Entries Deleted Count** – The number of LLDP neighbors which have been removed from the LLDP remote systems MIB for any reason.
- ◆ **Neighbor Entries Dropped Count** – The number of times which the remote database on this switch dropped an LLDPDU because of insufficient resources.

- ◆ **Neighbor Entries Age-out Count** – The number of times that a neighbor’s information has been deleted from the LLDP remote systems MIB because the remote TTL timer has expired.

Port/Trunk

- ◆ **Frames Discarded** – Number of frames discarded because they did not conform to the general validation rules as well as any specific usage rules defined for the particular TLV.
- ◆ **Frames Invalid** – A count of all LLDPDUs received with one or more detectable errors.
- ◆ **Frames Received** – Number of LLDP PDUs received.
- ◆ **Frames Sent** – Number of LLDP PDUs transmitted.
- ◆ **TLVs Unrecognized** – A count of all TLVs not recognized by the receiving LLDP local agent.
- ◆ **TLVs Discarded** – A count of all LLDPDUs received and then discarded due to insufficient memory space, missing or out-of-sequence attributes, or any other reason.
- ◆ **Neighbor Ageouts** – A count of the times that a neighbor’s information has been deleted from the LLDP remote systems MIB because the remote TTL timer has expired.

WEB INTERFACE

To display statistics for LLDP-capable devices attached to the switch:

1. Click Administration, LLDP.
2. Select Show Device Statistics from the Step list.
3. Select General, Port, or Trunk.

Figure 242: Displaying LLDP Device Statistics (General)

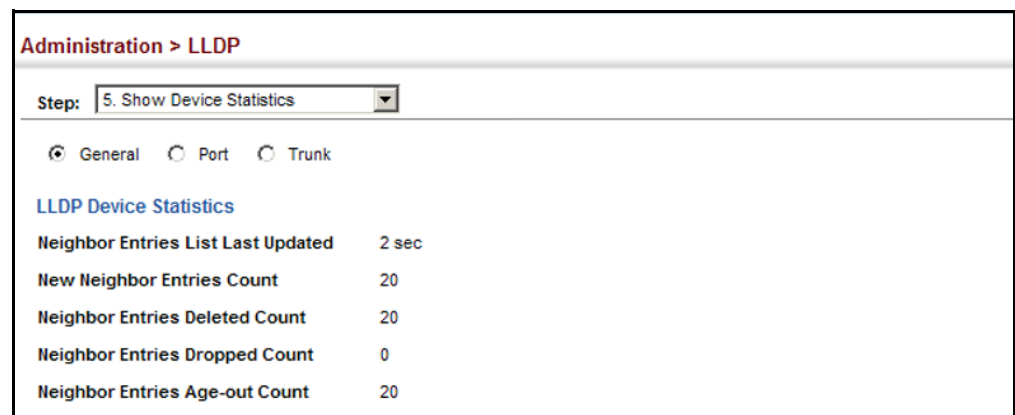
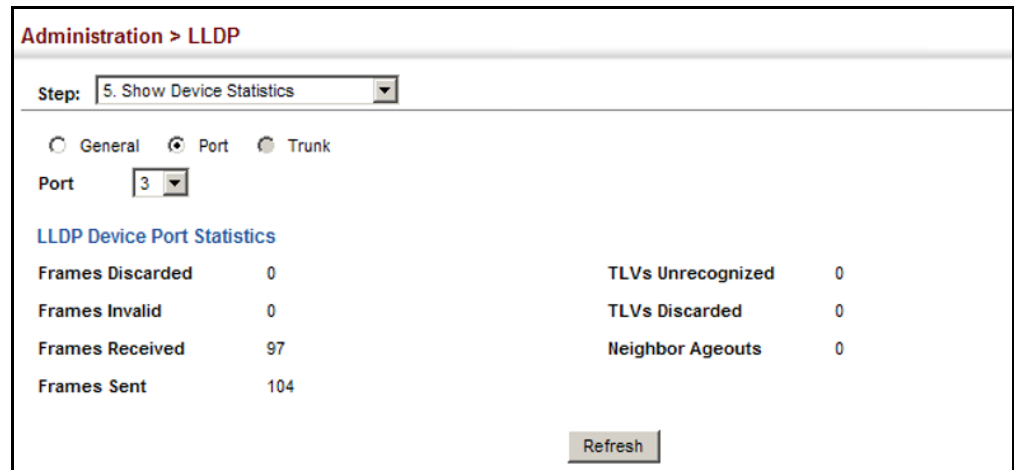

Figure 243: Displaying LLDP Device Statistics (Port)



POWER OVER ETHERNET

The ECS4110-28P/52P can provide DC power to a wide range of connected devices, eliminating the need for an additional power source and cutting down on the amount of cables attached to each device. Once configured to supply power, an automatic detection process is initialized by the switch that is authenticated by a PoE signature from the connected device. Detection and authentication prevent damage to non-compliant devices (prior to IEEE 802.3af).

The switch's power management enables individual port power to be controlled within the switch's power budget. Port power can be automatically turned on and off for connected devices, and a per-port power priority can be set so that the switch never exceeds its power budget. When a device is connected to a switch port, its power requirements are detected by the switch before power is supplied. If the power required by a device exceeds the power budget of the port or the whole switch, power is not supplied.

Ports can be set to one of three power priority levels, critical, high, or low. To control the power supply within the switch's budget, ports set at critical to high priority have power enabled in preference to those ports set at low priority. For example, when a device connected to a port is set to critical priority, the switch supplies the required power, if necessary by denying power to ports set for a lower priority during bootup.



NOTE: For more information on using the PoE provided by this switch refer to the *Installation Guide*.

SETTING THE SWITCH'S OVERALL PoE POWER BUDGET

Use the Administration > PoE > PSE (Configure Global) page to set the maximum PoE power budget for the switch (power available to all Gigabit Ethernet ports). If the power demand from devices connected to the switch exceeds the power budget, the switch uses port power priority settings to limit the supplied power.

CLI REFERENCES

- ◆ ["Power over Ethernet Commands" on page 1035](#)

PARAMETERS

These parameters are displayed:

- ◆ **PoE Maximum Available Power** – The power budget for the switch. If devices connected to the switch require more power than the switch budget, the port power priority settings are used to control the supplied power. (ECS4110-28P: 50000-390000 milliwatts; Default: 390000 milliwatts; ECS4110-52P: 50000-400000 milliwatts; Default: 400000 milliwatts)
- ◆ **System Operation Status** – Status of the PoE power service provided to the switch ports.
- ◆ **PoE Power Consumption** – The amount of power being consumed by PoE devices connected to the switch.
- ◆ **Software Version** – The version of software running on the PoE controller subsystem in the switch.
- ◆ **Compatible Mode** – Allows the switch to detect and provide power to powered devices that were designed prior to the IEEE 802.3af PoE standard. (Default: Disabled)

The switch automatically detects attached PoE devices by periodically transmitting test voltages that over the Gigabit Ethernet copper-media ports. When an IEEE 802.3af or 802.3at compatible device is plugged into one of these ports, the powered device reflects the test voltage back to the switch, which may then turn on the power to this device. When the compatibility mode is enabled, this switch can detect IEEE 802.3af or 802.3at compliant devices and the more recent 802.3af non-compliant devices that also reflect the test voltages back to the switch. It cannot detect other legacy devices that do not reflect back the test voltages.

For legacy devices to be supported by this switch, they must be able to accept power over the data pairs connected to the RJ-45 ports.

WEB INTERFACE

To set the overall PoE power budget for switch:

1. Click Administration, PoE, PSE.
2. Select Configure Global from the Step list.

3. Set the maximum PoE power provided by the switch, and enable the compatible mode if required.
4. Click Apply.

Figure 244: Setting the Switch’s PoE Budget

**SETTING THE PORT
PoE POWER BUDGET**

Use the Administration > PoE > PSE (Configure Interface) page to set the maximum power provided to a port.

CLI REFERENCES

- ◆ "Power over Ethernet Commands" on page 1035
- ◆ "Time Range" on page 782

COMMAND USAGE

- ◆ This switch supports both the IEEE 802.3af PoE and IEEE 802.3at-2009 PoE Plus standards. To ensure that the correct power is supplied to powered devices (PD) compliant with these standards, the first detection pulse from the switch is based on 802.3af to which the 802.3af PDs will respond normally. It then sends a second PoE Plus pulse that causes an 802.3at PD to respond as a Class 4 device and draw Class 4 current. Afterwards, the switch exchanges information with the PD such as duty-cycle, peak and average power needs.
- ◆ For the ECS4110-28P, the total PoE power delivered by all ports cannot exceed the maximum power budget of 390W. For the ECS4110-52P, the total PoE power delivered by all ports cannot exceed the maximum power budget of 400W. All the RJ-45 ports support both the IEEE 802.3af and IEEE 802.3at standards. The maximum number of ports which can supply power simultaneously at the specified levels are shown in the following table.

Table 31: Maximum Number of Ports Providing Simultaneous Power

Switch	34.2W (802.3at)	15.4W (802.3af)	7.5W (802.3af)
ECS4110-28P	11	24	24
ECS4110-52P	11	25	48

- ◆ If a device is connected to a switch port and the switch detects that it requires more than the power budget set for the port or to the overall switch, no power is supplied to the device (i.e., port power remains off).
- ◆ If the power demand from devices connected to all switch ports exceeds the power budget set for the switch, the port power priority settings are used to control the supplied power. For example:
 - If a device is connected to a low-priority port and causes the switch to exceed its budget, power to this port is not turned on.
 - If a device is connected to a critical or high-priority port and would cause the switch to exceed its power budget as determined during bootup, power is provided to the port only if the switch can drop power to one or more lower-priority ports and thereby remain within its overall budget.
 - If a device is connected to a port after the switch has finished booting up and would cause the switch to exceed its budget, power will not be provided to that port regardless of its priority setting.
 - If priority is not set for any ports, and PoE consumption exceeds the maximum power provided by the switch, power is shut down in the following sequence:

Table 32: PoE Shut Down Sequence

Switch	PoE Port Shut Down Sequence
ECS4110-28P	12, 11, 10, 9, 8, 7, 6, 5, 4, 3, 2, 1, 24, 23, 22, 21, 20, 19, 18, 17, 16, 15, 14, 13
ECS4110-52P	12, 11, 10, 9, 8, 7, 6, 5, 4, 3, 2, 1, 24, 23, 22, 21, 20, 19, 18, 17, 16, 15, 14, 13, 36, 35, 34, 33, 32, 31, 30, 29, 28, 27, 26, 25, 48, 47, 46, 45, 44, 43, 42, 41, 40, 39, 38, 37

PARAMETERS

These parameters are displayed:

- ◆ **Port** – The port number on the switch.
- ◆ **Admin Status** – Enables PoE power on a port. Power is automatically supplied when a device is detected on a port, providing that the power demanded does not exceed the switch or port power budget. (Default: Enabled)
- ◆ **Mode** – Shows whether or not PoE power is being supplied to a port.
- ◆ **Time Range Name** – Name of a time range. If a time range is set, then PoE will be provided to an interface during the specified period. (Range: 1-16 characters)
- ◆ **Time Range Status** – Indicates if a time range has been applied to an interface, and whether it is currently active or inactive.

- ◆ **Priority** – Sets the power priority for a port. (Options: Low, High, or Critical; Default: Low)
- ◆ **Power Allocation** – Sets the power budget for a port. (Range: 3000-34200 milliwatts; Default: 34200 milliwatts)
- ◆ **Power Consumption** – Current power consumption on a port.

WEB INTERFACE

To set the PoE power budget for a port:

1. Click Administration, PoE, PSE.
2. Enable PoE power on selected ports. Set the priority and the power budget. And specify a time range during which PoE will be provided to an interface.
3. Click Apply.

Figure 245: Setting a Port’s PoE Budget

Administration > PoE > PSE

Step: 2. Configure Interface

PoE Port List Total: 48

Port	Admin Status	Mode	Time-Range Name	Time-Range Status	Priority	Power Allocation	Power Consumption (milliwatts)
1	<input checked="" type="checkbox"/> Enabled	On	<input type="checkbox"/> R&D	NA	Low	34200	6800
2	<input checked="" type="checkbox"/> Enabled	off	<input type="checkbox"/> R&D	NA	Low	34200	0
3	<input checked="" type="checkbox"/> Enabled	off	<input type="checkbox"/> R&D	NA	Low	34200	0
4	<input checked="" type="checkbox"/> Enabled	off	<input type="checkbox"/> R&D	NA	Low	34200	0
5	<input checked="" type="checkbox"/> Enabled	off	<input type="checkbox"/> R&D	NA	Low	34200	0
6	<input checked="" type="checkbox"/> Enabled	off	<input type="checkbox"/> R&D	NA	Low	34200	0
7	<input checked="" type="checkbox"/> Enabled	off	<input type="checkbox"/> R&D	NA	Low	34200	0
8	<input checked="" type="checkbox"/> Enabled	off	<input type="checkbox"/> R&D	NA	Low	34200	0
9	<input checked="" type="checkbox"/> Enabled	off	<input type="checkbox"/> R&D	NA	Low	34200	0
10	<input checked="" type="checkbox"/> Enabled	off	<input type="checkbox"/> R&D	NA	Low	34200	0

Apply Revert

SIMPLE NETWORK MANAGEMENT PROTOCOL

Simple Network Management Protocol (SNMP) is a communication protocol designed specifically for managing devices on a network. Equipment commonly managed with SNMP includes switches, routers and host computers. SNMP is typically used to configure these devices for proper operation in a network environment, as well as to monitor them to evaluate performance or detect potential problems.

Managed devices supporting SNMP contain software, which runs locally on the device and is referred to as an agent. A defined set of variables, known as managed objects, is maintained by the SNMP agent and used to manage

the device. These objects are defined in a Management Information Base (MIB) that provides a standard presentation of the information controlled by the agent. SNMP defines both the format of the MIB specifications and the protocol used to access this information over the network.

The switch includes an onboard agent that supports SNMP versions 1, 2c, and 3. This agent continuously monitors the status of the switch hardware, as well as the traffic passing through its ports. A network management station can access this information using network management software. Access to the onboard agent from clients using SNMP v1 and v2c is controlled by community strings. To communicate with the switch, the management station must first submit a valid community string for authentication.

Access to the switch from clients using SNMPv3 provides additional security features that cover message integrity, authentication, and encryption; as well as controlling user access to specific areas of the MIB tree.

The SNMPv3 security structure consists of security models, with each model having its own security levels. There are three security models defined, SNMPv1, SNMPv2c, and SNMPv3. Users are assigned to "groups" that are defined by a security model and specified security levels. Each group also has a defined security access to set of MIB objects for reading and writing, which are known as "views." The switch has a default view (all MIB objects) and default groups defined for security models v1 and v2c. The following table shows the security models and levels available and the system default settings.

Table 33: SNMPv3 Security Models and Levels

Model	Level	Group	Read View	Write View	Notify View	Security
v1	noAuthNoPriv	public (read only)	defaultview	none	none	Community string only
v1	noAuthNoPriv	private (read/write)	defaultview	defaultview	none	Community string only
v1	noAuthNoPriv	<i>user defined</i>	<i>user defined</i>	<i>user defined</i>	<i>user defined</i>	Community string only
v2c	noAuthNoPriv	public (read only)	defaultview	none	none	Community string only
v2c	noAuthNoPriv	private (read/write)	defaultview	defaultview	none	Community string only
v2c	noAuthNoPriv	<i>user defined</i>	<i>user defined</i>	<i>user defined</i>	<i>user defined</i>	Community string only
v3	noAuthNoPriv	<i>user defined</i>	<i>user defined</i>	<i>user defined</i>	<i>user defined</i>	A user name match only
v3	AuthNoPriv	<i>user defined</i>	<i>user defined</i>	<i>user defined</i>	<i>user defined</i>	Provides user authentication via MD5 or SHA algorithms
v3	AuthPriv	<i>user defined</i>	<i>user defined</i>	<i>user defined</i>	<i>user defined</i>	Provides user authentication via MD5 or SHA algorithms and data privacy using DES 56-bit encryption



NOTE: The predefined default groups and view can be deleted from the system. You can then define customized groups and views for the SNMP clients that require access.

COMMAND USAGE

Configuring SNMPv1/2c Management Access

To configure SNMPv1 or v2c management access to the switch, follow these steps:

1. Use the Administration > SNMP (Configure Global) page to enable SNMP on the switch, and to enable trap messages.
2. Use the Administration > SNMP (Configure User - Add Community) page to configure the community strings authorized for management access.
3. Use the Administration > SNMP (Configure Trap) page to specify trap managers so that key events are reported by this switch to your management station.

Configuring SNMPv3 Management Access

1. Use the Administration > SNMP (Configure Global) page to enable SNMP on the switch, and to enable trap messages.
2. Use the Administration > SNMP (Configure Trap) page to specify trap managers so that key events are reported by this switch to your management station.
3. Use the Administration > SNMP (Configure Engine) page to change the local engine ID. If you want to change the default engine ID, it must be changed before configuring other parameters.
4. Use the Administration > SNMP (Configure View) page to specify read and write access views for the switch MIB tree.
5. Use the Administration > SNMP (Configure User) page to configure SNMP user groups with the required security model (i.e., SNMP v1, v2c or v3) and security level (i.e., authentication and privacy).
6. Use the Administration > SNMP (Configure Group) page to assign SNMP users to groups, along with their specific authentication and privacy passwords.

CONFIGURING GLOBAL SETTINGS FOR SNMP

Use the Administration > SNMP (Configure Global) page to enable SNMPv3 service for all management clients (i.e., versions 1, 2c, 3), and to enable trap messages.

CLI REFERENCES

- ◆ ["snmp-server" on page 795](#)
- ◆ ["snmp-server enable traps" on page 798](#)

PARAMETERS

These parameters are displayed:

- ◆ **Agent Status** – Enables SNMP on the switch. (Default: Enabled)
- ◆ **Authentication Traps**¹² – Issues a notification message to specified IP trap managers whenever an invalid community string is submitted during the SNMP access authentication process. (Default: Enabled)
- ◆ **Link-up and Link-down Traps**¹² – Issues a notification message whenever a port link is established or broken. (Default: Enabled)
- ◆ **MAC Notification Traps** – Issues a trap when a dynamic MAC address is added or removed.
- ◆ **MAC Notification Trap Interval** – Specifies the interval between issuing two consecutive traps. (Range: 1-3600 seconds; Default: 1 second)

WEB INTERFACE

To configure global settings for SNMP:

1. Click Administration, SNMP.
2. Select Configure Global from the Step list.
3. Enable SNMP and the required trap types.
4. Click Apply

Figure 246: Configuring Global Settings for SNMP

The screenshot shows a web configuration page for SNMP. At the top, it says 'Administration > SNMP'. Below that is a 'Step:' dropdown menu set to '1. Configure Global'. The main content area contains several settings:

- Agent Status**: Enabled
- Authentication Traps**: Enabled
- Link-up and Link-down Traps**: Enabled
- MAC Notification Traps**: Enabled
- MAC Notification Trap Interval (1 - 3600)**: sec

At the bottom right, there are two buttons: 'Apply' and 'Revert'.

12. These are legacy notifications and therefore when used for SNMPv3 hosts, they must be enabled in conjunction with the corresponding entries in the Notification View (page 458).

SETTING THE LOCAL ENGINE ID

Use the Administration > SNMP (Configure Engine - Set Engine ID) page to change the local engine ID. An SNMPv3 engine is an independent SNMP agent that resides on the switch. This engine protects against message replay, delay, and redirection. The engine ID is also used in combination with user passwords to generate the security keys for authenticating and encrypting SNMPv3 packets.

CLI REFERENCES

- ◆ "snmp-server engine-id" on page 803

COMMAND USAGE

- ◆ A local engine ID is automatically generated that is unique to the switch. This is referred to as the default engine ID. If the local engine ID is deleted or changed, all SNMP users will be cleared. You will need to reconfigure all existing users.

PARAMETERS

These parameters are displayed:

- ◆ **Engine ID** – A new engine ID can be specified by entering 9 to 64 hexadecimal characters (5 to 32 octets in hexadecimal format). If an odd number of characters are specified, a trailing zero is added to the value to fill in the last octet. For example, the value "123456789" is equivalent to "1234567890".
- ◆ **Engine Boots** – The number of times that the engine has (re-)initialized since the SNMP Engine ID was last configured.

WEB INTERFACE

To configure the local SNMP engine ID:

1. Click Administration, SNMP.
2. Select Configure Engine from the Step list.
3. Select Set Engine ID from the Action list.
4. Enter an ID of a least 9 hexadecimal characters.
5. Click Apply

Figure 247: Configuring the Local Engine ID for SNMP

The screenshot shows the web interface for configuring the local engine ID. The breadcrumb is "Administration > SNMP". The "Step" dropdown is set to "2. Configure Engine" and the "Action" dropdown is set to "Set Engine ID". The "Engine ID" field contains the hexadecimal value "800001030300000c000fd0000". The "Engine Boots" field is set to "5". At the bottom right, there are "Default" and "Save" buttons.

SPECIFYING A REMOTE ENGINE ID

Use the Administration > SNMP (Configure Engine - Add Remote Engine) page to configure a engine ID for a remote management station. To allow management access from an SNMPv3 user on a remote device, you must first specify the engine identifier for the SNMP agent on the remote device where the user resides. The remote engine ID is used to compute the security digest for authentication and encryption of packets passed between the switch and a user on the remote host.

CLI REFERENCES

- ◆ ["snmp-server engine-id" on page 803](#)

COMMAND USAGE

- ◆ SNMP passwords are localized using the engine ID of the authoritative agent. For informs, the authoritative SNMP agent is the remote agent. You therefore need to configure the remote agent's SNMP engine ID before you can send proxy requests or informs to it. (See ["Configuring Remote SNMPv3 Users" on page 469.](#))

PARAMETERS

These parameters are displayed:

- ◆ **Remote Engine ID** – The engine ID can be specified by entering 9 to 64 hexadecimal characters (5 to 32 octets in hexadecimal format). If an odd number of characters are specified, a trailing zero is added to the value to fill in the last octet. For example, the value "123456789" is equivalent to "1234567890".
- ◆ **Remote IP Host** – The IPv4 or IPv6 address of a remote management station which is using the specified engine ID.

WEB INTERFACE

To configure a remote SNMP engine ID:

1. Click Administration, SNMP.
2. Select Configure Engine from the Step list.
3. Select Add Remote Engine from the Action list.
4. Enter an ID of a least 9 hexadecimal characters, and the IP address of the remote host.
5. Click Apply

Figure 248: Configuring a Remote Engine ID for SNMP

To show the remote SNMP engine IDs:

1. Click Administration, SNMP.
2. Select Configure Engine from the Step list.
3. Select Show Remote Engine from the Action list.

Figure 249: Showing Remote Engine IDs for SNMP

SNMPv3 Remote Engine List <small>Total: 1</small>		
<input type="checkbox"/>	Remote Engine ID	Remote IP Host
<input type="checkbox"/>	5432100000	192.168.1.19

**SETTING
SNMPv3 VIEWS**

Use the Administration > SNMP (Configure View) page to configure SNMPv3 views which are used to restrict user access to specified portions of the MIB tree. The predefined view "defaultview" includes access to the entire MIB tree.

CLI REFERENCES

- ◆ "snmp-server view" on page 806

PARAMETERS

These parameters are displayed:

Add View

- ◆ **View Name** – The name of the SNMP view. (Range: 1-32 characters)
- ◆ **OID Subtree** – Specifies the initial object identifier of a branch within the MIB tree. Wild cards can be used to mask a specific portion of the OID string. Use the Add OID Subtree page to configure additional object identifiers. (Range: 1-64 characters)
- ◆ **Type** – Indicates if the object identifier of a branch within the MIB tree is included or excluded from the SNMP view.

Add OID Subtree

- ◆ **View Name** – Lists the SNMP views configured in the Add View page. (Range: 1-32 characters)
- ◆ **OID Subtree** – Adds an additional object identifier of a branch within the MIB tree to the selected View. Wild cards can be used to mask a specific portion of the OID string. (Range: 1-64 characters)
- ◆ **Type** – Indicates if the object identifier of a branch within the MIB tree is included or excluded from the SNMP view.

WEB INTERFACE

To configure an SNMP view of the switch’s MIB database:

1. Click Administration, SNMP.
2. Select Configure View from the Step list.
3. Select Add View from the Action list.
4. Enter a view name and specify the initial OID subtree in the switch’s MIB database to be included or excluded in the view. Use the Add OID Subtree page to add additional object identifier branches to the view.
5. Click Apply

Figure 250: Creating an SNMP View

The screenshot shows a web interface for configuring an SNMP view. At the top, the breadcrumb is "Administration > SNMP". Below this, there are two dropdown menus: "Step" is set to "3. Configure View" and "Action" is set to "Add View". The main form has three fields: "View Name" with the value "ifEntry.a", "OID Subtree" with the value "1.3.6.1.2.1.2.2.1.1.*", and "Type" with a dropdown menu set to "Included". At the bottom right of the form, there are two buttons: "Apply" and "Revert".

To show the SNMP views of the switch’s MIB database:

1. Click Administration, SNMP.
2. Select Configure View from the Step list.
3. Select Show View from the Action list.

Figure 251: Showing SNMP Views

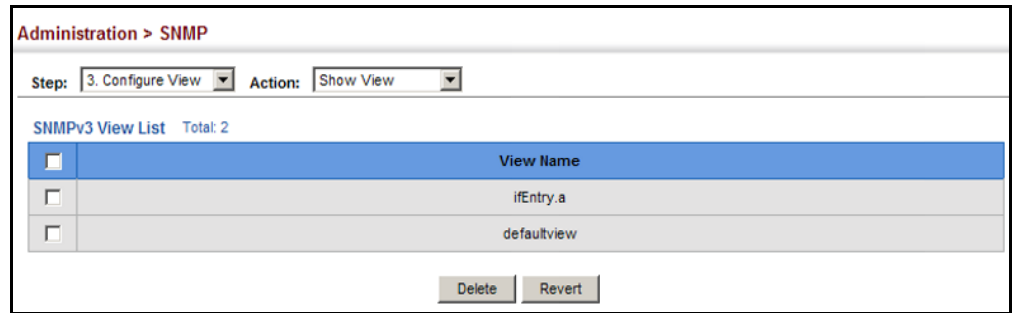

To add an object identifier to an existing SNMP view of the switch's MIB database:

1. Click Administration, SNMP.
2. Select Configure View from the Step list.
3. Select Add OID Subtree from the Action list.
4. Select a view name from the list of existing views, and specify an additional OID subtree in the switch's MIB database to be included or excluded in the view.
5. Click Apply

Figure 252: Adding an OID Subtree to an SNMP View

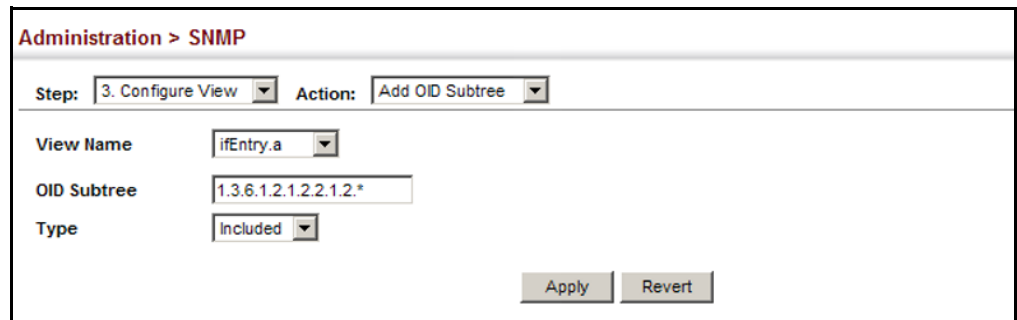

To show the OID branches configured for the SNMP views of the switch's MIB database:

1. Click Administration, SNMP.
2. Select Configure View from the Step list.
3. Select Show OID Subtree from the Action list.
4. Select a view name from the list of existing views.

Figure 253: Showing the OID Subtree Configured for SNMP Views

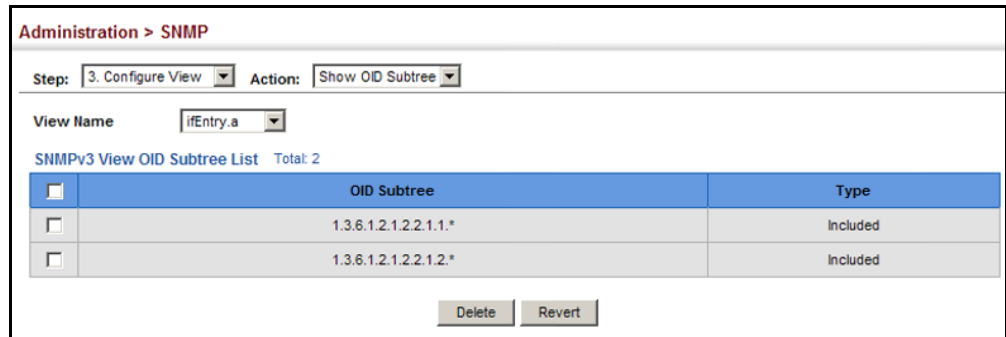

CONFIGURING SNMPv3 GROUPS

Use the Administration > SNMP (Configure Group) page to add an SNMPv3 group which can be used to set the access policy for its assigned users, restricting them to specific read, write, and notify views. You can use the pre-defined default groups or create new groups to map a set of SNMP users to SNMP views.

CLI REFERENCES

- ◆ ["show snmp group" on page 808](#)

PARAMETERS

These parameters are displayed:

- ◆ **Group Name** – The name of the SNMP group to which the user is assigned. (Range: 1-32 characters)
- ◆ **Security Model** – The user security model; SNMP v1, v2c or v3.
- ◆ **Security Level** – The following security levels are only used for the groups assigned to the SNMP security model:
 - **noAuthNoPriv** – There is no authentication or encryption used in SNMP communications. (This is the default security level.)
 - **AuthNoPriv** – SNMP communications use authentication, but the data is not encrypted.
 - **AuthPriv** – SNMP communications use both authentication and encryption.
- ◆ **Read View** – The configured view for read access. (Range: 1-32 characters)
- ◆ **Write View** – The configured view for write access. (Range: 1-32 characters)
- ◆ **Notify View** – The configured view for notifications. (Range: 1-32 characters)

Table 34: Supported Notification Messages

Model	Level	Group
<i>RFC 1493 Traps</i>		
newRoot	1.3.6.1.2.1.17.0.1	The newRoot trap indicates that the sending agent has become the new root of the Spanning Tree; the trap is sent by a bridge soon after its election as the new root, e.g., upon expiration of the Topology Change Timer immediately subsequent to its election.
topologyChange	1.3.6.1.2.1.17.0.2	A topologyChange trap is sent by a bridge when any of its configured ports transitions from the Learning state to the Forwarding state, or from the Forwarding state to the Discarding state. The trap is not sent if a newRoot trap is sent for the same transition.
<i>SNMPv2 Traps</i>		
coldStart	1.3.6.1.6.3.1.1.5.1	A coldStart trap signifies that the SNMPv2 entity, acting in an agent role, is reinitializing itself and that its configuration may have been altered.
warmStart	1.3.6.1.6.3.1.1.5.2	A warmStart trap signifies that the SNMPv2 entity, acting in an agent role, is reinitializing itself such that its configuration is unaltered.
linkDown*	1.3.6.1.6.3.1.1.5.3	A linkDown trap signifies that the SNMP entity, acting in an agent role, has detected that the ifOperStatus object for one of its communication links is about to enter the down state from some other state (but not from the notPresent state). This other state is indicated by the included value of ifOperStatus.
linkUp*	1.3.6.1.6.3.1.1.5.4	A linkUp trap signifies that the SNMP entity, acting in an agent role, has detected that the ifOperStatus object for one of its communication links left the down state and transitioned into some other state (but not into the notPresent state). This other state is indicated by the included value of ifOperStatus.
authenticationFailure*	1.3.6.1.6.3.1.1.5.5	An authenticationFailure trap signifies that the SNMPv2 entity, acting in an agent role, has received a protocol message that is not properly authenticated. While all implementations of the SNMPv2 must be capable of generating this trap, the snmpEnableAuthenTraps object indicates whether this trap will be generated.
<i>RMON Events (V2)</i>		
risingAlarm	1.3.6.1.2.1.16.0.1	The SNMP trap that is generated when an alarm entry crosses its rising threshold and generates an event that is configured for sending SNMP traps.
fallingAlarm	1.3.6.1.2.1.16.0.2	The SNMP trap that is generated when an alarm entry crosses its falling threshold and generates an event that is configured for sending SNMP traps.

Table 34: Supported Notification Messages (Continued)

Model	Level	Group
<i>Private Traps</i>		
swPowerStatusChangeTrap	1.3.6.1.4.1.259.10.1.39.2.1.0.1	This trap is sent when the power state changes.
swPortSecurityTrap	1.3.6.1.4.1.259.10.1.39.2.1.0.36	This trap is sent when the port is being intruded. This trap will only be sent when the portSecActionTrap is enabled.
swIpFilterRejectTrap	1.3.6.1.4.1.259.10.1.39.2.1.0.40	This trap is sent when an incorrect IP address is rejected by the IP filter.
swAtcBcastStormAlarmFireTrap	1.3.6.1.4.1.259.10.1.39.2.1.0.70	When broadcast traffic is detected as a storm, this trap is fired.
swAtcBcastStormAlarmClearTrap	1.3.6.1.4.1.259.10.1.39.2.1.0.71	When a broadcast storm is detected as normal traffic, this trap is fired.
swAtcBcastStormTcApplyTrap	1.3.6.1.4.1.259.10.1.39.2.1.0.72	When ATC is activated, this trap is fired.
swAtcBcastStormTcReleaseTrap	1.3.6.1.4.1.259.10.1.39.2.1.0.73	When ATC is released, this trap is fired.
swAtcMcastStormAlarmFireTrap	1.3.6.1.4.1.259.10.1.39.2.1.0.74	When multicast traffic is detected as the storm, this trap is fired.
swAtcMcastStormAlarmClearTrap	1.3.6.1.4.1.259.10.1.39.2.1.0.75	When multicast storm is detected as normal traffic, this trap is fired.
swAtcMcastStormTcApplyTrap	1.3.6.1.4.1.259.10.1.39.2.1.0.76	When ATC is activated, this trap is fired.
swAtcMcastStormTcReleaseTrap	1.3.6.1.4.1.259.10.1.39.2.1.0.77	When ATC is released, this trap is fired.
stpBpduGuardPortShutdownTrap	1.3.6.1.4.1.259.10.1.39.2.1.0.91	This trap will be sent when an interface is shut down because of BPDU guard.
swLoopbackDetectionTrap	1.3.6.1.4.1.259.10.1.39.2.1.0.95	This trap is sent when loopback BPDUs have been detected.
networkAccessPortLinkDetectionTrap	1.3.6.1.4.1.259.10.1.39.2.1.0.96	This trap is sent when a networkAccessPortLinkDetection event is triggered.
dot1agCfmMepUpTrap	1.3.6.1.4.1.259.10.1.39.2.1.0.97	This trap is sent when a new remote MEP is discovered.
dot1agCfmMepDownTrap	1.3.6.1.4.1.259.10.1.39.2.1.0.98	This trap is sent when port status or interface status TLV received from remote MEP indicates it is not up.
dot1agCfmConfigFailTrap	1.3.6.1.4.1.259.10.1.39.2.1.0.99	This trap is sent when a MEP receives a CCM with MPID which already exists on the same MA in this switch.
dot1agCfmLoopFindTrap	1.3.6.1.4.1.259.10.1.39.2.1.0.100	This trap is sent when a MEP receives its own CCMs.
dot1agCfmMepUnknownTrap	1.3.6.1.4.1.259.10.1.39.2.1.0.101	This trap is sent when a CCM is received from an unexpected MEP.
dot1agCfmMepMissingTrap	1.3.6.1.4.1.259.10.1.39.2.1.0.102	This trap is sent when the cross-check enable timer expires and no CCMs were received from an expected (configured) MEP.
dot1agCfmMaUpTrap	1.3.6.1.4.1.259.10.1.39.2.1.0.103	This trap is sent when all expected remote MEPs are up.
autoUpgradeTrap	1.3.6.1.4.1.259.10.1.39.2.1.0.104	This trap is sent when auto upgrade is executed.

Table 34: Supported Notification Messages (Continued)

Model	Level	Group
swCpuUtiRisingNotification	1.3.6.1.4.1.259.10.1.39.2.1.0.107	This notification indicates that the CPU utilization has risen from <code>cpuUtiFallingThreshold</code> to <code>cpuUtiRisingThreshold</code> .
swCpuUtiFallingNotification	1.3.6.1.4.1.259.10.1.39.2.1.0.108	This notification indicates that the CPU utilization has fallen from <code>cpuUtiRisingThreshold</code> to <code>cpuUtiFallingThreshold</code> .
swMemoryUtiRisingThresholdNotification	1.3.6.1.4.1.259.10.1.39.2.1.0.109	This notification indicates that the memory utilization has risen from <code>memoryUtiFallingThreshold</code> to <code>memoryUtiRisingThreshold</code> .
swMemoryUtiFallingThresholdNotification	1.3.6.1.4.1.259.10.1.39.2.1.0.110	This notification indicates that the memory utilization has fallen from <code>memoryUtiRisingThreshold</code> to <code>memoryUtiFallingThreshold</code> .
dhcpRogueServerAttackTrap	1.3.6.1.4.1.259.10.1.39.2.1.0.114	This trap is sent when receiving a DHCP packet from a rogue server.
macNotificationTrap	1.3.6.1.4.1.259.10.1.39.2.1.0.138	This trap is sent when there are changes of the dynamic MAC addresses on the switch.
lbdDetectionTrap	1.3.6.1.4.1.259.10.1.39.2.1.0.141	This trap is sent when a loopback condition is detected by LBD.
lbdRecoveryTrap	1.3.6.1.4.1.259.10.1.39.2.1.0.142	This trap is sent when a recovery is done by LBD.
sfpThresholdAlarmWarnTrap	1.3.6.1.4.1.259.10.1.39.2.1.0.189	This trap is sent when the SFP's monitored value is not within alarm/warning thresholds.
udldPortShutdownTrap	1.3.6.1.4.1.259.10.1.39.2.1.0.192	This trap is sent when the port is shut down by UDLD.
userAuthenticationFailureTrap	1.3.6.1.4.1.259.10.1.39.2.1.0.199	This trap will be triggered if authentication fails.
userAuthenticationSuccessTrap	1.3.6.1.4.1.259.10.1.39.2.1.0.200	This trap will be triggered if authentication is successful.
loginTrap	1.3.6.1.4.1.259.10.1.39.2.1.0.201	This trap is sent when user logs in.
logoutTrap	1.3.6.1.4.1.259.10.1.39.2.1.0.202	This trap is sent when user logs out.
fileCopyTrap	1.3.6.1.4.1.259.10.1.39.2.1.0.208	This trap is sent when file copy is executed. If the copy action is triggered by the system, the login user information (<code>trapVarLoginUserName/ trapVarSessionType/ trapVarLoginInetAddressTypes/ trapVarLoginInetAddress</code>) will be a null value.
userauthCreateUserTrap	1.3.6.1.4.1.259.10.1.39.2.1.0.209	This trap is sent when a user account is created.
userauthDeleteUserTrap	1.3.6.1.4.1.259.10.1.39.2.1.0.210	This trap is sent when a user account is deleted.
userauthModifyUserPrivilegeTrap	1.3.6.1.4.1.259.10.1.39.2.1.0.211	This trap is sent when user privilege is modified.

* These are legacy notifications and therefore must be enabled in conjunction with the corresponding traps on the SNMP Configuration menu.

WEB INTERFACE

To configure an SNMP group:

1. Click Administration, SNMP.
2. Select Configure Group from the Step list.
3. Select Add from the Action list.
4. Enter a group name, assign a security model and level, and then select read, write, and notify views.
5. Click Apply

Figure 254: Creating an SNMP Group

To show SNMP groups:

1. Click Administration, SNMP.
2. Select Configure Group from the Step list.
3. Select Show from the Action list.

Figure 255: Showing SNMP Groups

<input type="checkbox"/>	Group Name	Model	Level	Read View	Write View	Notify View
<input type="checkbox"/>	public	v1	noAuthNoPriv	defaultview	none	none
<input type="checkbox"/>	public	v2c	noAuthNoPriv	defaultview	none	none
<input type="checkbox"/>	private	v1	noAuthNoPriv	defaultview	defaultview	none
<input type="checkbox"/>	private	v2c	noAuthNoPriv	defaultview	defaultview	none
<input type="checkbox"/>	secure-users	v3	authPriv	ifEntry.a	ifEntry.a	ifEntry.a

Delete Revert

SETTING COMMUNITY ACCESS STRINGS Use the Administration > SNMP (Configure User - Add Community) page to configure up to five community strings authorized for management access by clients using SNMP v1 and v2c. For security reasons, you should consider removing the default strings.

CLI REFERENCES

- ◆ "snmp-server community" on page 795

PARAMETERS

These parameters are displayed:

- ◆ **Community String** – A community string that acts like a password and permits access to the SNMP protocol.
Range: 1-32 characters, case sensitive
Default strings: "public" (Read-Only), "private" (Read/Write)
- ◆ **Access Mode** – Specifies the access rights for the community string:
 - **Read-Only** – Authorized management stations are only able to retrieve MIB objects.
 - **Read/Write** – Authorized management stations are able to both retrieve and modify MIB objects.

WEB INTERFACE

To set a community access string:

1. Click Administration, SNMP.
2. Select Configure User from the Step list.
3. Select Add Community from the Action list.
4. Add new community strings as required, and select the corresponding access rights from the Access Mode list.
5. Click Apply

Figure 256: Setting Community Access Strings

The screenshot shows a web interface for configuring SNMP community strings. At the top, it displays the breadcrumb "Administration > SNMP". Below this, there are two dropdown menus: "Step:" set to "5. Configure User" and "Action:" set to "Add Community". The main configuration area contains two fields: "Community String" with the value "spiderman" and "Access Mode" with the value "Read/Write". At the bottom right of the form, there are two buttons: "Apply" and "Revert".

To show the community access strings:

1. Click Administration, SNMP.
2. Select Configure User from the Step list.
3. Select Show Community from the Action list.

Figure 257: Showing Community Access Strings

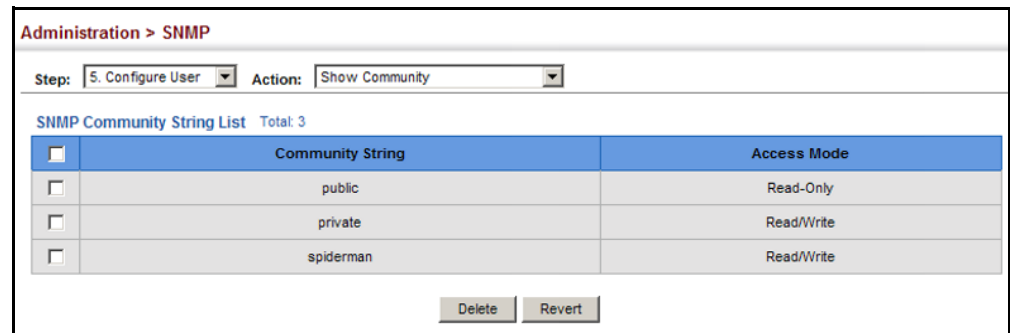

CONFIGURING LOCAL SNMPV3 USERS

Use the Administration > SNMP (Configure User - Add SNMPv3 Local User) page to authorize management access for SNMPv3 clients, or to identify the source of SNMPv3 trap messages sent from the local switch. Each SNMPv3 user is defined by a unique name. Users must be configured with a specific security level and assigned to a group. The SNMPv3 group restricts users to a specific read, write, and notify view.

CLI REFERENCES

- ◆ ["snmp-server user" on page 805](#)

PARAMETERS

These parameters are displayed:

- ◆ **User Name** – The name of user connecting to the SNMP agent. (Range: 1-32 characters)
- ◆ **Group Name** – The name of the SNMP group to which the user is assigned. (Range: 1-32 characters)
- ◆ **Security Model** – The user security model; SNMP v1, v2c or v3.
- ◆ **Security Level** – The following security levels are only used for the groups assigned to the SNMP security model:
 - **noAuthNoPriv** – There is no authentication or encryption used in SNMP communications. (This is the default security level.)
 - **AuthNoPriv** – SNMP communications use authentication, but the data is not encrypted.

- **AuthPriv** – SNMP communications use both authentication and encryption.
- ◆ **Authentication Protocol** – The method used for user authentication. (Options: MD5, SHA; Default: MD5)
- ◆ **Authentication Password** – Enter plain text characters for the authentication password. (Range: 8-32 characters)
- ◆ **Privacy Protocol** – The encryption algorithm use for data privacy; only 56-bit DES is currently available.
- ◆ **Privacy Password** – Enter plain text characters for the privacy password. (Range: 8-32 characters)

WEB INTERFACE

To configure a local SNMPv3 user:

1. Click Administration, SNMP.
2. Select Configure User from the Step list.
3. Select Add SNMPv3 Local User from the Action list.
4. Enter a name and assign it to a group. If the security model is set to SNMPv3 and the security level is authNoPriv or authPriv, then an authentication protocol and password must be specified. If the security level is authPriv, a privacy password must also be specified.
5. Click Apply

Figure 258: Configuring Local SNMPv3 Users

Administration > SNMP

Step: 5. Configure User Action: Add SNMPv3 Local User

SNMPv3 User

User Name: chris

Group Name: public r&d

Security Model: v3

Security Level: authPriv

User Authentication

Authentication Protocol: MD5

Authentication Password: greenpeace

Data Privacy

Privacy Protocol: DES56

Privacy Password: einstien

Apply Revert

To show local SNMPv3 users:

1. Click Administration, SNMP.
2. Select Configure User from the Step list.
3. Select Show SNMPv3 Local User from the Action list.

Figure 259: Showing Local SNMPv3 Users

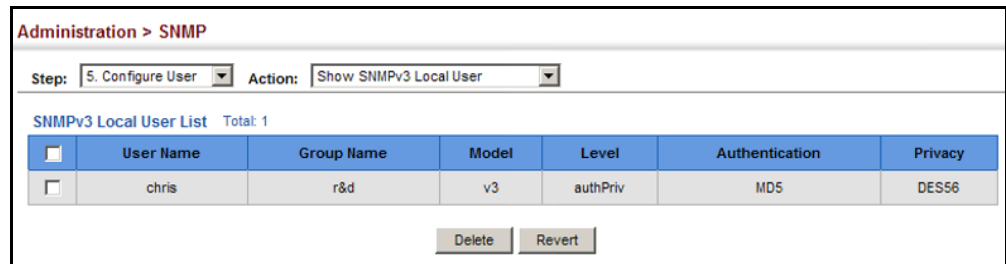

CONFIGURING REMOTE SNMPv3 USERS

Use the Administration > SNMP (Configure User - Add SNMPv3 Remote User) page to identify the source of SNMPv3 inform messages sent from the local switch. Each SNMPv3 user is defined by a unique name. Users must be configured with a specific security level and assigned to a group. The SNMPv3 group restricts users to a specific read, write, and notify view.

CLI REFERENCES

- ◆ ["snmp-server user" on page 805](#)

COMMAND USAGE

- ◆ To grant management access to an SNMPv3 user on a remote device, you must first specify the engine identifier for the SNMP agent on the remote device where the user resides. The remote engine ID is used to compute the security digest for authentication and encryption of packets passed between the switch and the remote user. (See ["Specifying Trap Managers" on page 472](#) and ["Specifying a Remote Engine ID" on page 457.](#))

PARAMETERS

These parameters are displayed:

- ◆ **User Name** – The name of user connecting to the SNMP agent. (Range: 1-32 characters)
- ◆ **Group Name** – The name of the SNMP group to which the user is assigned. (Range: 1-32 characters)
- ◆ **Remote IP** – The IPv4 or IPv6 address of the remote device where the user resides.
- ◆ **Security Model** – The user security model; SNMP v1, v2c or v3. (Default: v3)

- ◆ **Security Level** – The following security levels are only used for the groups assigned to the SNMP security model:
 - **noAuthNoPriv** – There is no authentication or encryption used in SNMP communications. (This is the default security level.)
 - **AuthNoPriv** – SNMP communications use authentication, but the data is not encrypted.
 - **AuthPriv** – SNMP communications use both authentication and encryption.
- ◆ **Authentication Protocol** – The method used for user authentication. (Options: MD5, SHA; Default: MD5)
- ◆ **Authentication Password** – Enter plain text characters for the authentication password. (Range: 8-32 characters)
- ◆ **Privacy Protocol** – The encryption algorithm use for data privacy; only 56-bit DES is currently available.
- ◆ **Privacy Password** – Enter plain text characters for the privacy password. (Range: 8-32 characters)

WEB INTERFACE

To configure a remote SNMPv3 user:

1. Click Administration, SNMP.
2. Select Configure User from the Step list.
3. Select Add SNMPv3 Remote User from the Action list.
4. Enter a name and assign it to a group. Enter the IP address to identify the source of SNMPv3 inform messages sent from the local switch. If the security model is set to SNMPv3 and the security level is authNoPriv or authPriv, then an authentication protocol and password must be specified. If the security level is authPriv, a privacy password must also be specified.
5. Click Apply

Figure 260: Configuring Remote SNMPv3 Users

Administration > SNMP

Step: 5. Configure User Action: Add SNMPv3 Remote User

SNMPv3 User

User Name: mark

Group Name: public r&d

Remote IP: 192.168.1.19

Security Model: v3

Security Level: authPriv

User Authentication

Authentication Protocol: MD5

Authentication Password: greenpeace

Data Privacy

Privacy Protocol: DES56

Privacy Password: einstien

Apply Revert

To show remote SNMPv3 users:

1. Click Administration, SNMP.
2. Select Configure User from the Step list.
3. Select Show SNMPv3 Remote User from the Action list.

Figure 261: Showing Remote SNMPv3 Users

Administration > SNMP

Step: 5. Configure User Action: Show SNMPv3 Remote User

SNMPv3 Remote User List Total: 1

<input type="checkbox"/>	User Name	Group Name	Engine ID	Model	Level	Authentication	Privacy
<input type="checkbox"/>	mark	r&d	5432100000	v3	authPriv	MD5	DES56

Delete Revert

SPECIFYING TRAP MANAGERS

Use the Administration > SNMP (Configure Trap) page to specify the host devices to be sent traps and the types of traps to send. Traps indicating status changes are issued by the switch to the specified trap managers. You must specify trap managers so that key events are reported by this switch to your management station (using network management software). You can specify up to five management stations that will receive authentication failure messages and other trap messages from the switch.

CLI REFERENCES

- ◆ "snmp-server host" on page 799
- ◆ "snmp-server enable traps" on page 798

COMMAND USAGE

- ◆ Notifications are issued by the switch as trap messages by default. The recipient of a trap message does not send a response to the switch. Traps are therefore not as reliable as inform messages, which include a request for acknowledgement of receipt. Informs can be used to ensure that critical information is received by the host. However, note that informs consume more system resources because they must be kept in memory until a response is received. Informs also add to network traffic. You should consider these effects when deciding whether to issue notifications as traps or informs.

To send an inform to a SNMPv2c host, complete these steps:

1. Enable the SNMP agent ([page 454](#)).
2. Create a view with the required notification messages ([page 458](#)).
3. Configure the group (matching the community string specified on the Configure Trap - Add page) to include the required notify view ([page 461](#)).
4. Enable trap informs as described in the following pages.

To send an inform to a SNMPv3 host, complete these steps:

1. Enable the SNMP agent ([page 454](#)).
2. Create a remote SNMPv3 user to use in the message exchange process ([page 467](#)). If the user specified in the trap configuration page does not exist, an SNMPv3 group will be automatically created using the name of the specified remote user, and default settings for the read, write, and notify view.
3. Create a view with the required notification messages ([page 458](#)).
4. Create a group that includes the required notify view ([page 461](#)).
5. Enable trap informs as described in the following pages.

PARAMETERS

These parameters are displayed:

SNMP Version 1

- ◆ **IP Address** – IPv4 or IPv6 address of a new management station to receive notification message (i.e., the targeted recipient).
- ◆ **Version** – Specifies whether to send notifications as SNMP v1, v2c, or v3 traps. (Default: v1)
- ◆ **Community String** – Specifies a valid community string for the new trap manager entry. (Range: 1-32 characters, case sensitive)
Although you can set this string in the Configure Trap – Add page, we recommend defining it in the Configure User – Add Community page.
- ◆ **UDP Port** – Specifies the UDP port number used by the trap manager. (Default: 162)

SNMP Version 2c

- ◆ **IP Address** – IPv4 or IPv6 address of a new management station to receive notification message (i.e., the targeted recipient).
- ◆ **Version** – Specifies whether to send notifications as SNMP v1, v2c, or v3 traps.
- ◆ **Notification Type**
 - **Traps** – Notifications are sent as trap messages.
 - **Inform** – Notifications are sent as inform messages. Note that this option is only available for version 2c and 3 hosts. (Default: traps are used)
 - **Timeout** – The number of seconds to wait for an acknowledgment before resending an inform message. (Range: 0-2147483647 centiseconds; Default: 1500 centiseconds)
 - **Retry times** – The maximum number of times to resend an inform message if the recipient does not acknowledge receipt. (Range: 0-255; Default: 3)
- ◆ **Community String** – Specifies a valid community string for the new trap manager entry. (Range: 1-32 characters, case sensitive)
Although you can set this string in the Configure Trap – Add page, we recommend defining it in the Configure User – Add Community page.
- ◆ **UDP Port** – Specifies the UDP port number used by the trap manager. (Default: 162)

SNMP Version 3

- ◆ **IP Address** – IPv4 or IPv6 address of a new management station to receive notification message (i.e., the targeted recipient).
- ◆ **Version** – Specifies whether to send notifications as SNMP v1, v2c, or v3 traps.
- ◆ **Notification Type**
 - **Traps** – Notifications are sent as trap messages.
 - **Inform** – Notifications are sent as inform messages. Note that this option is only available for version 2c and 3 hosts. (Default: traps are used)
 - **Timeout** – The number of seconds to wait for an acknowledgment before resending an inform message. (Range: 0-2147483647 centiseconds; Default: 1500 centiseconds)
 - **Retry times** – The maximum number of times to resend an inform message if the recipient does not acknowledge receipt. (Range: 0-255; Default: 3)
- ◆ **Local User Name** – The name of a local user which is used to identify the source of SNMPv3 trap messages sent from the local switch. (Range: 1-32 characters)

If an account for the specified user has not been created ([page 467](#)), one will be automatically generated.
- ◆ **Remote User Name** – The name of a remote user which is used to identify the source of SNMPv3 inform messages sent from the local switch. (Range: 1-32 characters)

If an account for the specified user has not been created ([page 469](#)), one will be automatically generated.
- ◆ **UDP Port** – Specifies the UDP port number used by the trap manager. (Default: 162)
- ◆ **Security Level** – When trap version 3 is selected, you must specify one of the following security levels. (Default: noAuthNoPriv)
 - **noAuthNoPriv** – There is no authentication or encryption used in SNMP communications.
 - **AuthNoPriv** – SNMP communications use authentication, but the data is not encrypted.
 - **AuthPriv** – SNMP communications use both authentication and encryption.

WEB INTERFACE

To configure trap managers:

1. Click Administration, SNMP.
2. Select Configure Trap from the Step list.
3. Select Add from the Action list.
4. Fill in the required parameters based on the selected SNMP version.
5. Click Apply

Figure 262: Configuring Trap Managers (SNMPv1)

Administration > SNMP

Step: 6. Configure Trap Action: Add

IP Address: 192.168.0.3

Version: v1

Community String: private

UDP Port (1-65535): 162

Apply Revert

Figure 263: Configuring Trap Managers (SNMPv2c)

Administration > SNMP

Step: 6. Configure Trap Action: Add

IP Address: 192.168.2.9

Version: v2c

Notification Type: Inform

Timeout (0-2147483647): centiseconds

Retry Times (0-255):

Community String: venus

UDP Port (1-65535):

Apply Revert

Figure 264: Configuring Trap Managers (SNMPv3)

Administration > SNMP

Step: 6. Configure Trap Action: Add

IP Address: 192.168.2.9

Version: v3

Notification Type: Inform

Timeout (0-2147483647): centiseconds

Retry Times (0-255):

Remote User Name:

UDP Port (1-65535):

Security Level: authPriv

Apply Revert

To show configured trap managers:

1. Click Administration, SNMP.
2. Select Configure Trap from the Step list.
3. Select Show from the Action list.

Figure 265: Showing Trap Managers

Administration > SNMP

Step: 6. Configure Trap Action: Show

SNMP Trap Manager List Total: 5

<input type="checkbox"/>	IP Address	Version	Community String/User Name	UDP Port	Security Level	Timeout	Retry Times
<input type="checkbox"/>	192.168.0.4	v3	steve	162	noAuthNoPriv		
<input type="checkbox"/>	192.168.0.5	v3	bobby	162	noAuthNoPriv		
<input type="checkbox"/>	192.168.0.6	v3	betty	162	authNoPriv		
<input type="checkbox"/>	192.168.2.9	v2c	venus	162		1600	5
<input type="checkbox"/>	192.168.5.8	v3	margaret	162	authPriv	1600	5

Delete Revert

CREATING SNMP NOTIFICATION LOGS

Use the Administration > SNMP (Configure Notify Filter - Add) page to create an SNMP notification log.

CLI REFERENCES

- ◆ "nlm" on page 810
- ◆ "snmp-server notify-filter" on page 811
- ◆ "show nlm oper-status" on page 812
- ◆ "show snmp notify-filter" on page 813

COMMAND USAGE

- ◆ Systems that support SNMP often need a mechanism for recording Notification information as a hedge against lost notifications, whether there are Traps or Informs that may be exceeding retransmission limits.

The Notification Log MIB (NLM, RFC 3014) provides an infrastructure in which information from other MIBs may be logged.

- ◆ Given the service provided by the NLM, individual MIBs can now bear less responsibility to record transient information associated with an event against the possibility that the Notification message is lost, and applications can poll the log to verify that they have not missed any important Notifications.
- ◆ If notification logging is not configured, when the switch reboots, some SNMP traps (such as warm start) cannot be logged.
- ◆ To avoid this problem, notification logging should be configured as described in this section, and these commands stored in the startup configuration file using the System > File (Copy – Running-Config) page as described on [page 131](#). Then when the switch reboots, SNMP traps (such as warm start) can now be logged.
- ◆ Based on the default settings used in RFC 3014, a notification log can contain up to 256 entries, and the entry aging time is 1440 minutes. Information recorded in a notification log, and the entry aging time can only be configured using SNMP from a network management station.
- ◆ When a trap host is created using the Administration > SNMP (Configure Trap – Add) page described on [page 472](#), a default notify filter will be created.

PARAMETERS

These parameters are displayed:

- ◆ **IP Address** – The IPv4 or IPv6 address of a remote device. The specified target host must already have been configured using the Administration > SNMP (Configure Trap – Add) page.

The notification log is stored locally. It is not sent to a remote device. This remote host parameter is only required to complete mandatory fields in the SNMP Notification MIB.

- ◆ **Filter Profile Name** – Notification log profile name. (Range: 1-32 characters)

WEB INTERFACE

To create an SNMP notification log:

1. Click Administration, SNMP.
2. Select Configure Notify Filter from the Step list.
3. Select Add from the Action list.
4. Fill in the IP address of a configured trap manager and the filter profile name.

5. Click Apply

Figure 266: Creating SNMP Notification Logs

Administration > SNMP

Step: 7. Configure Notify Filter Action: Add

IP Address: 192.168.0.99

Filter Profile Name: R&D

Apply Revert

To show configured SNMP notification logs:

1. Click Administration, SNMP.
2. Select Configure Notify Filter from the Step list.
3. Select Show from the Action list.

Figure 267: Showing SNMP Notification Logs

Administration > SNMP

Step: 7. Configure Notify Filter Action: Show

SNMP Notify Filter List Total: 1

<input type="checkbox"/>	Filter profile name	IP Address
<input type="checkbox"/>	R&D	192.168.0.99

Delete Revert

SHOWING SNMP STATISTICS

Use the Administration > SNMP (Show Statistics) page to show counters for SNMP input and output protocol data units.

CLI REFERENCES

- ◆ "show snmp" on page 797

PARAMETERS

The following counters are displayed:

- ◆ **SNMP packets input** – The total number of messages delivered to the SNMP entity from the transport service.
- ◆ **Bad SNMP version errors** – The total number of SNMP messages which were delivered to the SNMP entity and were for an unsupported SNMP version.
- ◆ **Unknown community name** – The total number of SNMP messages delivered to the SNMP entity which used a SNMP community name not known to said entity.

- ◆ **Illegal operation for community name supplied** – The total number of SNMP messages delivered to the SNMP entity which represented an SNMP operation which was not allowed by the SNMP community named in the message.
- ◆ **Encoding errors** – The total number of ASN.1 or BER errors encountered by the SNMP entity when decoding received SNMP messages.
- ◆ **Number of requested variables** – The total number of MIB objects which have been retrieved successfully by the SNMP protocol entity as the result of receiving valid SNMP Get-Request and Get-Next PDUs.
- ◆ **Number of altered variables** – The total number of MIB objects which have been altered successfully by the SNMP protocol entity as the result of receiving valid SNMP Set-Request PDUs.
- ◆ **Get-request PDUs** – The total number of SNMP Get-Request PDUs which have been accepted and processed, or generated, by the SNMP protocol entity.
- ◆ **Get-next PDUs** – The total number of SNMP Get-Next PDUs which have been accepted and processed, or generated, by the SNMP protocol entity.
- ◆ **Set-request PDUs** – The total number of SNMP Set-Request PDUs which have been accepted and processed, or generated, by the SNMP protocol entity.
- ◆ **SNMP packets output** – The total number of SNMP Messages which were passed from the SNMP protocol entity to the transport service.
- ◆ **Too big errors** – The total number of SNMP PDUs which were generated by the SNMP protocol entity and for which the value of the error-status field is "tooBig."
- ◆ **No such name errors** – The total number of SNMP PDUs which were delivered to, or generated by, the SNMP protocol entity and for which the value of the error-status field is "noSuchName."
- ◆ **Bad values errors** – The total number of SNMP PDUs which were delivered to, or generated by, the SNMP protocol entity and for which the value of the error-status field is "badValue."
- ◆ **General errors** – The total number of SNMP PDUs which were delivered to, or generated by, the SNMP protocol entity and for which the value of the error-status field is "genErr."
- ◆ **Response PDUs** – The total number of SNMP Get-Response PDUs which have been accepted and processed by, or generated by, the SNMP protocol entity.
- ◆ **Trap PDUs** – The total number of SNMP Trap PDUs which have been accepted and processed by, or generated by, the SNMP protocol entity.

WEB INTERFACE

To show SNMP statistics:

1. Click Administration, SNMP.
2. Select Show Statistics from the Step list.

Figure 268: Showing SNMP Statistics

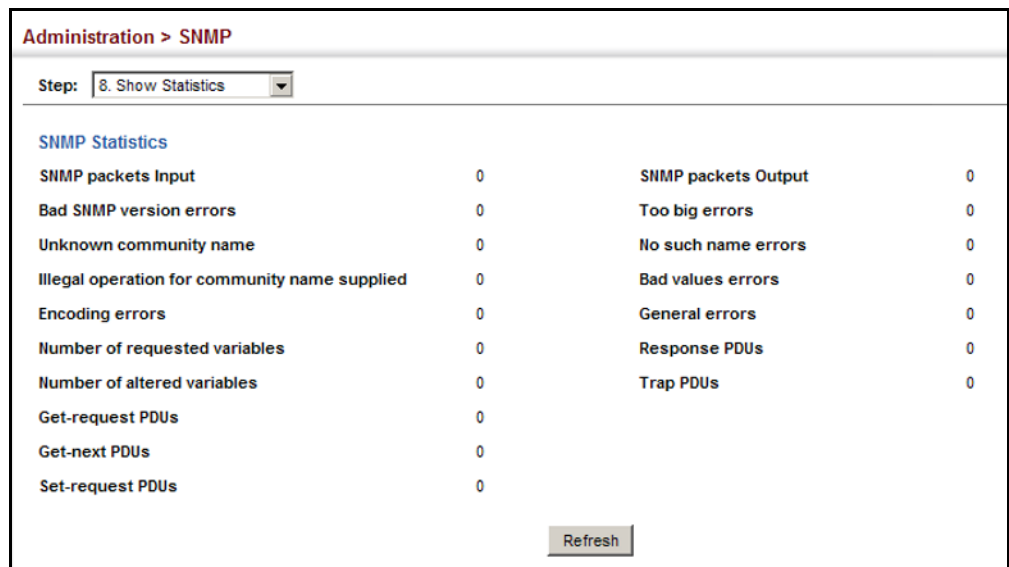

REMOTE MONITORING

Remote Monitoring allows a remote device to collect information or respond to specified events on an independent basis. This switch is an RMON-capable device which can independently perform a wide range of tasks, significantly reducing network management traffic. It can continuously run diagnostics and log information on network performance. If an event is triggered, it can automatically notify the network administrator of a failure and provide historical information about the event. If it cannot connect to the management agent, it will continue to perform any specified tasks and pass data back to the management station the next time it is contacted.

The switch supports mini-RMON, which consists of the Statistics, History, Event and Alarm groups. When RMON is enabled, the system gradually builds up information about its physical interfaces, storing this information in the relevant RMON database group. A management agent then periodically communicates with the switch using the SNMP protocol. However, if the switch encounters a critical event, it can automatically send a trap message to the management agent which can then respond to the event if so configured.

CONFIGURING RMON ALARMS

Use the Administration > RMON (Configure Global - Add - Alarm) page to define specific criteria that will generate response events. Alarms can be set to test data over any specified time interval, and can monitor absolute or changing values (such as a statistical counter reaching a specific value, or a statistic changing by a certain amount over the set interval). Alarms can be set to respond to rising or falling thresholds. (However, note that after an alarm is triggered it will not be triggered again until the statistical value crosses the opposite bounding threshold and then back across the trigger threshold.

CLI REFERENCES

- ◆ "Remote Monitoring Commands" on page 815

COMMAND USAGE

- ◆ If an alarm is already defined for an index, the entry must be deleted before any changes can be made.

PARAMETERS

These parameters are displayed:

- ◆ **Index** – Index to this entry. (Range: 1-65535)
- ◆ **Variable** – The object identifier of the MIB variable to be sampled. Only variables of the type etherStatsEntry.n.n may be sampled.
Note that etherStatsEntry.n uniquely defines the MIB variable, and etherStatsEntry.n.n defines the MIB variable, plus the etherStatsIndex. For example, 1.3.6.1.2.1.16.1.1.1.6.1 denotes etherStatsBroadcastPkts, plus the etherStatsIndex of 1.
- ◆ **Interval** – The polling interval. (Range: 1-31622400 seconds)
- ◆ **Sample Type** – Tests for absolute or relative changes in the specified variable.
 - **Absolute** – The variable is compared directly to the thresholds at the end of the sampling period.
 - **Delta** – The last sample is subtracted from the current value and the difference is then compared to the thresholds.
- ◆ **Rising Threshold** – If the current value is greater than or equal to the rising threshold, and the last sample value was less than this threshold, then an alarm will be generated. After a rising event has been generated, another such event will not be generated until the sampled value has fallen below the rising threshold, reaches the falling threshold, and again moves back up to the rising threshold. (Range: 0-2147483647)
- ◆ **Rising Event Index** – The index of the event to use if an alarm is triggered by monitored variables reaching or crossing above the rising threshold. If there is no corresponding entry in the event control table, then no event will be generated. (Range: 0-65535)

- ◆ **Falling Threshold** – If the current value is less than or equal to the falling threshold, and the last sample value was greater than this threshold, then an alarm will be generated. After a falling event has been generated, another such event will not be generated until the sampled value has risen above the falling threshold, reaches the rising threshold, and again moves back down to the failing threshold. (Range: 0-2147483647)
- ◆ **Falling Event Index** – The index of the event to use if an alarm is triggered by monitored variables reaching or crossing below the falling threshold. If there is no corresponding entry in the event control table, then no event will be generated. (Range: 0-65535)
- ◆ **Owner** – Name of the person who created this entry. (Range: 1-127 characters)

WEB INTERFACE

To configure an RMON alarm:

1. Click Administration, RMON.
2. Select Configure Global from the Step list.
3. Select Add from the Action list.
4. Click Alarm.
5. Enter an index number, the MIB object to be polled (etherStatsEntry.n.n), the polling interval, the sample type, the thresholds, and the event to trigger.
6. Click Apply

Figure 269: Configuring an RMON Alarm

The screenshot shows the 'Administration > RMON' configuration page. At the top, there are two dropdown menus: 'Step: 1. Configure Global' and 'Action: Add'. Below these are two radio buttons: 'Alarm' (selected) and 'Event'. The main configuration area contains several fields:

Index (1-65535)	1
Variable	6.1
Interval (1-31622400)	15 sec
Sample Type	Delta
Rising Threshold (0-2147483647)	100
Rising Event Index (0-65535)	30
Falling Threshold (0-2147483647)	1
Falling Event Index (0-65535)	2
Owner	bill

At the bottom right, there are two buttons: 'Apply' and 'Revert'.

To show configured RMON alarms:

1. Click Administration, RMON.
2. Select Configure Global from the Step list.
3. Select Show from the Action list.
4. Click Alarm.

Figure 270: Showing Configured RMON Alarms

<input type="checkbox"/>	Index	Status	Variable	Interval	Type	Last Value	Rising Threshold	Rising Event Index	Falling Threshold	Falling Event Index	Owner
<input type="checkbox"/>	1	Valid	1.3.6.1.2.1.16.1.1.1.6.1	30	Delta	23	892800	0	446400	0	
<input type="checkbox"/>	2	Valid	1.3.6.1.2.1.16.1.1.1.6.2	30	Delta	0	892800	0	446400	0	
<input type="checkbox"/>	3	Valid	1.3.6.1.2.1.16.1.1.1.6.3	30	Delta	0	892800	0	446400	0	
<input type="checkbox"/>	4	Valid	1.3.6.1.2.1.16.1.1.1.6.4	30	Delta	0	892800	0	446400	0	
<input type="checkbox"/>	5	Valid	1.3.6.1.2.1.16.1.1.1.6.5	30	Delta	0	892800	0	446400	0	

CONFIGURING RMON EVENTS

Use the Administration > RMON (Configure Global - Add - Event) page to set the action to take when an alarm is triggered. The response can include logging the alarm or sending a message to a trap manager. Alarms and corresponding events provide a way of immediately responding to critical network problems.

CLI REFERENCES

- ◆ ["Remote Monitoring Commands" on page 815](#)

COMMAND USAGE

- ◆ If an alarm is already defined for an index, the entry must be deleted before any changes can be made.
- ◆ One default event is configured as follows:
 - event Index = 1
 - Description: RMON_TRAP_LOG
 - Event type: log & trap
 - Event community name is public
 - Owner is RMON_SNMP

PARAMETERS

These parameters are displayed:

- ◆ **Index** – Index to this entry. (Range: 1-65535)

- ◆ **Type** – Specifies the type of event to initiate:
 - **None** – No event is generated.
 - **Log** – Generates an RMON log entry when the event is triggered. Log messages are processed based on the current configuration settings for event logging (see "[System Log Configuration](#)" on page 422).
 - **Trap** – Sends a trap message to all configured trap managers (see "[Specifying Trap Managers](#)" on page 472).
 - **Log and Trap** – Logs the event and sends a trap message.
- ◆ **Community** – A password-like community string sent with the trap operation to SNMP v1 and v2c hosts.

Although the community string can be set on this configuration page, it is recommended that it be defined on the SNMP trap configuration page (see "[Setting Community Access Strings](#)" on page 466) prior to configuring it here. (Range: 1-127 characters)
- ◆ **Description** – A comment that describes this event. (Range: 1-127 characters)
- ◆ **Owner** – Name of the person who created this entry. (Range: 1-127 characters)

WEB INTERFACE

To configure an RMON event:

1. Click Administration, RMON.
2. Select Configure Global from the Step list.
3. Select Add from the Action list.
4. Click Event.
5. Enter an index number, the type of event to initiate, the community string to send with trap messages, the name of the person who created this event, and a brief description of the event.
6. Click Apply

Figure 271: Configuring an RMON Event

To show configured RMON events:

1. Click Administration, RMON.
2. Select Configure Global from the Step list.
3. Select Show from the Action list.
4. Click Event.

Figure 272: Showing Configured RMON Events

<input type="checkbox"/>	Index	Status	Type	Community	Description	Owner	Last Fired
<input type="checkbox"/>	1	Valid	None		None	None	00:00:00
<input type="checkbox"/>	2	Valid	Log		Log	Log	00:00:00
<input type="checkbox"/>	3	Valid	Trap	Trap	Trap	Trap	00:00:00
<input type="checkbox"/>	4	Valid	Log and Trap	Log and Trap	Log and Trap	Log and Trap	00:00:00

CONFIGURING RMON HISTORY SAMPLES

Use the Administration > RMON (Configure Interface - Add - History) page to collect statistics on a physical interface to monitor network utilization, packet types, and errors. A historical record of activity can be used to track down intermittent problems. The record can be used to establish normal baseline activity, which may reveal problems associated with high traffic levels, broadcast storms, or other unusual events. It can also be used to predict network growth and plan for expansion before your network becomes too overloaded.

CLI REFERENCES

- ◆ "Remote Monitoring Commands" on page 815

COMMAND USAGE

- ◆ Each index number equates to a port on the switch.
- ◆ If history collection is already enabled on an interface, the entry must be deleted before any changes can be made.
- ◆ The information collected for each sample includes:
input octets, packets, broadcast packets, multicast packets, undersize packets, oversize packets, fragments, jabbers, CRC alignment errors, collisions, drop events, and network utilization.

For a description of the statistics displayed on the Show Details page, refer to ["Showing Port or Trunk Statistics" on page 166](#).
- ◆ The switch reserves two index entries for each port. If a default index entry is re-assigned to another port using the Add page, this index will not appear in the Show nor Show Details page for the port to which is normally assigned. For example, if control entry 15 is assigned to port 5, this index entry will be removed from the Show and Show Details page for port 8.

PARAMETERS

These parameters are displayed:

- ◆ **Port** - The port number on the switch.
- ◆ **Index** - Index to this entry. (Range: 1-65535)
- ◆ **Interval** - The polling interval. (Range: 1-3600 seconds; Default: 1800 seconds)
- ◆ **Buckets** - The number of buckets requested for this entry. (Range: 1-65536; Default: 50)

The number of buckets granted are displayed on the Show page.
- ◆ **Owner** - Name of the person who created this entry. (Range: 1-127 characters)

WEB INTERFACE

To periodically sample statistics on a port:

1. Click Administration, RMON.
2. Select Configure Interface from the Step list.
3. Select Add from the Action list.
4. Click History.
5. Select a port from the list as the data source.
6. Enter an index number, the sampling interval, the number of buckets to use, and the name of the owner for this entry.

7. Click Apply

Figure 273: Configuring an RMON History Sample

The screenshot shows the 'Administration > RMON' configuration page. At the top, 'Step: 2. Configure Interface' and 'Action: Add' are selected. Below this, there are radio buttons for 'History' (selected) and 'Statistics'. A 'Port' dropdown is set to '2'. The 'Index (1-65535)' field contains '100', 'Interval (1-3600)' contains '60' with 'sec' to its right, 'Buckets (1-65535)' contains '10', and 'Owner' contains 'david'. At the bottom right, there are 'Apply' and 'Revert' buttons.

To show configured RMON history samples:

1. Click Administration, RMON.
2. Select Configure Interface from the Step list.
3. Select Show from the Action list.
4. Select a port from the list.
5. Click History.

Figure 274: Showing Configured RMON History Samples

The screenshot shows the 'Administration > RMON' configuration page with 'Step: 2. Configure Interface' and 'Action: Show' selected. Below the configuration fields, there is a table titled 'RMON History Port List' with a 'Total: 2' indicator. The table has columns for Index, Status, Interval, Requested Buckets, Granted Buckets, and Owner. Two rows are shown, both with a 'Valid' status. Below the table are 'Delete' and 'Revert' buttons.

<input type="checkbox"/>	Index	Status	Interval	Requested Buckets	Granted Buckets	Owner
<input type="checkbox"/>	1	Valid	1800	8	8	
<input type="checkbox"/>	2	Valid	30	8	8	

To show collected RMON history samples:

1. Click Administration, RMON.
2. Select Configure Interface from the Step list.
3. Select Show Details from the Action list.
4. Select a port from the list.

5. Click History.

Figure 275: Showing Collected RMON History Samples

History Index	Sample Index	Interval Start	Octets	Packets	Broadcast Packets	Multicast Packets	Undersize Packets	Oversize Packets	Fragments	Jabbers	CRC Align Errors	Collisions	Drop Events	Network Utilization
1	1	00:00:01	756105	3218	91	894	0	0	0	0	0	0	0	0
2	71	00:35:01	21490	76	0	15	0	0	0	0	0	0	0	0
2	72	00:35:31	46521	120	0	15	0	0	0	0	0	0	0	0
2	73	00:36:01	21682	79	0	15	0	0	0	0	0	0	0	0
2	74	00:36:31	21554	77	0	15	0	0	0	0	0	0	0	0

CONFIGURING RMON STATISTICAL SAMPLES

Use the Administration > RMON (Configure Interface - Add - Statistics) page to collect statistics on a port, which can subsequently be used to monitor the network for common errors and overall traffic rates.

CLI REFERENCES

- ◆ "Remote Monitoring Commands" on page 815

COMMAND USAGE

- ◆ If statistics collection is already enabled on an interface, the entry must be deleted before any changes can be made.
- ◆ The information collected for each entry includes:
input octets, packets, broadcast packets, multicast packets, undersize packets, oversize packets, CRC alignment errors, jabbers, fragments, collisions, drop events, and frames of various sizes.

PARAMETERS

These parameters are displayed:

- ◆ **Port** – The port number on the switch.
- ◆ **Index** - Index to this entry. (Range: 1-65535)
- ◆ **Owner** - Name of the person who created this entry. (Range: 1-127 characters)

WEB INTERFACE

To enable regular sampling of statistics on a port:

1. Click Administration, RMON.
2. Select Configure Interface from the Step list.
3. Select Add from the Action list.

4. Click Statistics.
5. Select a port from the list as the data source.
6. Enter an index number, and the name of the owner for this entry
7. Click Apply

Figure 276: Configuring an RMON Statistical Sample

Administration > RMON

Step: 2. Configure Interface Action: Add

History Statistics

Port 2

Index (1-65535) 100

Owner mary

Apply Revert

To show configured RMON statistical samples:

1. Click Administration, RMON.
2. Select Configure Interface from the Step list.
3. Select Show from the Action list.
4. Select a port from the list.
5. Click Statistics.

Figure 277: Showing Configured RMON Statistical Samples

Administration > RMON

Step: 2. Configure Interface Action: Show

History Statistics

Port 2

RMON Statistics Port List Total: 2

<input type="checkbox"/>	Index	Status	Owner
<input type="checkbox"/>	1	Valid	abc
<input type="checkbox"/>	2	Valid	test

Delete Revert

To show collected RMON statistical samples:

1. Click Administration, RMON.
2. Select Configure Interface from the Step list.

3. Select Show Details from the Action list.
4. Select a port from the list.
5. Click Statistics.

Figure 278: Showing Collected RMON Statistical Samples

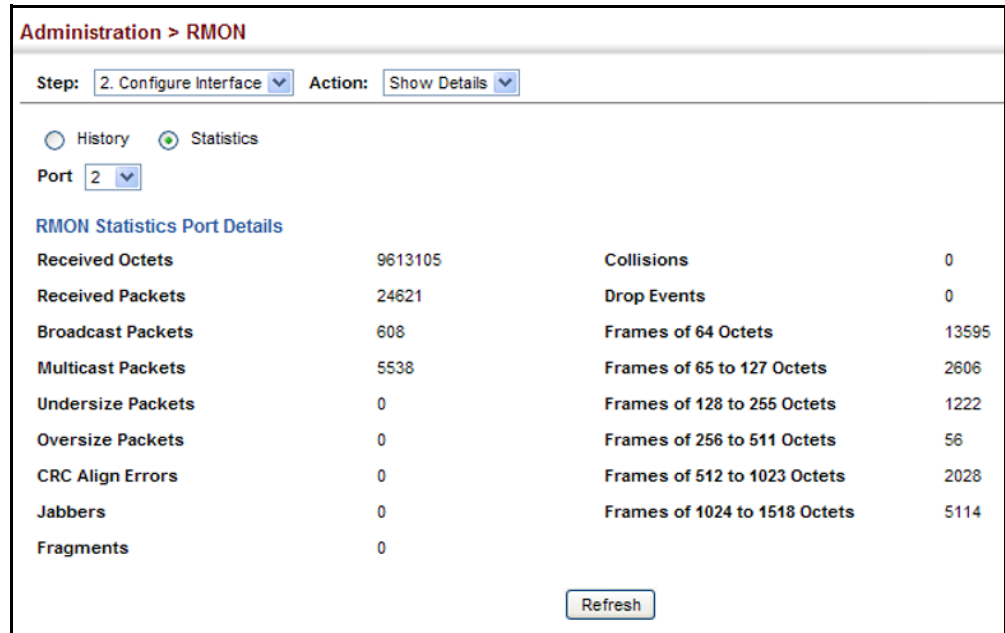

SWITCH CLUSTERING

Switch clustering is a method of grouping switches together to enable centralized management through a single unit. Switches that support clustering can be grouped together regardless of physical location or switch type, as long as they are connected to the same local network.

COMMAND USAGE

- ◆ A switch cluster has a primary unit called the "Commander" which is used to manage all other "Member" switches in the cluster. The management station can use either Telnet or the web interface to communicate directly with the Commander through its IP address, and then use the Commander to manage Member switches through the cluster's "internal" IP addresses.
- ◆ Clustered switches must be in the same Ethernet broadcast domain. In other words, clustering only functions for switches which can pass information between the Commander and potential Candidates or active Members through VLAN 4093.
- ◆ Once a switch has been configured to be a cluster Commander, it automatically discovers other cluster-enabled switches in the network. These "Candidate" switches only become cluster Members when

manually selected by the administrator through the management station.

- ◆ There can be up to 100 candidates and 36 member switches in one cluster.
- ◆ A switch can only be a member of one cluster.
- ◆ The cluster VLAN 4093 is not configured by default. Before using clustering, take the following actions to set up this VLAN:
 1. Create VLAN 4093 (see ["Configuring VLAN Groups" on page 202](#)).
 2. Add the participating ports to this VLAN (see ["Adding Static Members to VLANs" on page 205](#)), and set them to hybrid mode, tagged members, PVID = 1, and acceptable frame type = all.
- ◆ After the Commander and Members have been configured, any switch in the cluster can be managed from the web agent by choosing the desired Member ID from the Show Member page.

CONFIGURING GENERAL SETTINGS FOR CLUSTERS

Use the Administration > Cluster (Configure Global) page to create a switch cluster.

CLI REFERENCES

- ◆ ["Switch Clustering" on page 786](#)

COMMAND USAGE

First be sure that clustering is enabled on the switch (the default is disabled), then set the switch as a Cluster Commander. Set a Cluster IP Pool that does not conflict with the network IP subnet. Cluster IP addresses are assigned to switches when they become Members and are used for communication between Member switches and the Commander.

PARAMETERS

These parameters are displayed:

- ◆ **Cluster Status** – Enables or disables clustering on the switch. (Default: Disabled)
- ◆ **Commander Status** – Enables or disables the switch as a cluster Commander. (Default: Disabled)
- ◆ **IP Pool** – An "internal" IP address pool that is used to assign IP addresses to Member switches in the cluster. Internal cluster IP addresses are in the form 10.x.x.member-ID. Only the base IP address of the pool needs to be set since Member IDs can only be between 1 and 36. Note that you cannot change the cluster IP pool when the switch is currently in Commander mode. Commander mode must first be disabled. (Default: 10.254.254.1)
- ◆ **Role** – Indicates the current role of the switch in the cluster; either Commander, Member, or Candidate. (Default: Candidate)

- ◆ **Number of Members** – The current number of Member switches in the cluster.
- ◆ **Number of Candidates** – The current number of Candidate switches discovered in the network that are available to become Members.

WEB INTERFACE

To configure a switch cluster:

1. Click Administration, Cluster.
2. Select Configure Global from the Step list.
3. Set the required attributes for a Commander or a managed candidate.
4. Click Apply

Figure 279: Configuring a Switch Cluster

The screenshot shows the 'Administration > Cluster' configuration page. At the top, there is a breadcrumb 'Administration > Cluster' and a 'Step:' dropdown menu set to '1. Configure Global'. Below this, the configuration parameters are listed:

Cluster Status	<input checked="" type="checkbox"/> Enabled
Commander Status	<input checked="" type="checkbox"/> Enabled
IP Pool	<input type="text" value="10.254.254.1"/>
Role	Commander
Number of Members	2
Number of Candidates	3

At the bottom right of the form, there are two buttons: 'Apply' and 'Revert'.

CLUSTER MEMBER CONFIGURATION Use the Administration > Cluster (Configure Member - Add) page to add Candidate switches to the cluster as Members.

CLI REFERENCES

- ◆ ["Switch Clustering" on page 786](#)

PARAMETERS

These parameters are displayed:

- ◆ **Member ID** – Specify a Member ID number for the selected Candidate switch. (Range: 1-36)
- ◆ **MAC Address** – Select a discovered switch MAC address from the Candidate Table, or enter a specific MAC address of a known switch.

WEB INTERFACE

To configure cluster members:

1. Click Administration, Cluster.
2. Select Configure Member from the Step list.
3. Select Add from the Action list.
4. Select one of the cluster candidates discovered by this switch, or enter the MAC address of a candidate.
5. Click Apply.

Figure 280: Configuring a Cluster Members

To show the cluster members:

1. Click Administration, Cluster.
2. Select Configure Member from the Step list.
3. Select Show from the Action list.

Figure 281: Showing Cluster Members

<input type="checkbox"/>	Member ID	Role	IP Address	MAC Address	Description
<input type="checkbox"/>	1	Active Member	10.254.254.2	11-22-33-44-55-33	ECS4210-52T
<input type="checkbox"/>	2	Candidate	10.254.254.3	11-22-33-44-55-77	ECS4210-52T

To show cluster candidates:

1. Click Administration, Cluster.
2. Select Configure Member from the Step list.
3. Select Show Candidate from the Action list.

Figure 282: Showing Cluster Candidates

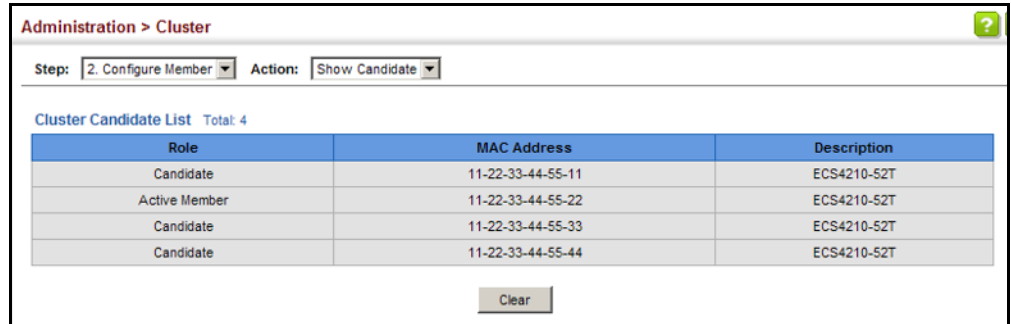

MANAGING CLUSTER MEMBERS

Use the Administration > Cluster (Show Member) page to manage another switch in the cluster.

CLI REFERENCES

◆ "Switch Clustering" on page 786

PARAMETERS

These parameters are displayed:

Member ID – The ID number of the Member switch. (Range: 1-36)

Role – Indicates the current status of the switch in the cluster.

IP Address – The internal cluster IP address assigned to the Member switch.

MAC Address – The MAC address of the Member switch.

Description – The system description string of the Member switch.

Operate – Remotely manage a cluster member.

WEB INTERFACE

To manage a cluster member:

1. Click Administration, Cluster.
2. Select Show Member from the Step list.
3. Select an entry from the Cluster Member List.
4. Click Operate.

Figure 283: Managing a Cluster Member

The screenshot shows a web interface for managing a cluster. At the top, it says "Administration > Cluster" with a help icon. Below that, a "Step:" dropdown menu is set to "3. Show Member". The main content is a "Cluster Member List" table with a "Total: 2" label. The table has six columns: Member ID, Role, IP Address, MAC Address, and Description. There are two rows of data. Below the table is an "Operate" button.

	Member ID	Role	IP Address	MAC Address	Description
<input checked="" type="radio"/>	1	Active Member	10.254.254.2	11-22-33-44-55-33	ECS4210-52T
<input type="radio"/>	2	Candidate	10.254.254.3	11-22-33-44-55-77	ECS4210-52T

ETHERNET RING PROTECTION SWITCHING



NOTE: Information in this section is based on ITU-T G.8032/Y.1344.

The ITU G.8032 recommendation specifies a protection switching mechanism and protocol for Ethernet layer network rings. Ethernet rings can provide wide-area multipoint connectivity more economically due to their reduced number of links. The mechanisms and protocol defined in G.8032 achieve highly reliable and stable protection; and never form loops, which would fatally affect network operation and service availability.

The G.8032 recommendation, also referred to as Ethernet Ring Protection Switching (ERPS), can be used to increase the availability and robustness of Ethernet rings. An Ethernet ring built using ERPS can provide resilience at a lower cost and than that provided by SONET or EAPS rings.

ERPS is more economical than EAPS in that only one physical link is required between each node in the ring. However, since it can tolerate only one break in the ring, it is not as robust as EAPS. ERPS supports up to 255 nodes in the ring structure. ERPS requires a higher convergence time when more than 16 nodes are used, but should always run under than 500 ms.

Operational Concept

Loop avoidance in the ring is achieved by guaranteeing that, at any time, traffic may flow on all but one of the ring links. This particular link is called the ring protection link (RPL), and under normal conditions this link is blocked to traffic. One designated node, the RPL owner, is responsible for blocking traffic over the RPL. When a ring failure occurs, the RPL owner is responsible for unblocking the RPL, allowing this link to be used for traffic.

Ring nodes may be in one of two states:

- Idle – normal operation, no link/node faults detected in ring
- Protection – Protection switching in effect after identifying a signal fault

In Idle state, the physical topology has all nodes connected in a ring. The logical topology guarantees that all nodes are connected without a loop by

blocking the RPL. Each link is monitored by its two adjacent nodes using Connectivity Fault Management (CFM) protocol messages.

Protection switching (opening the RPL to traffic) occurs when a signal failure message generated by the Connectivity Fault Management (CFM) protocol is declared on one of the ring links, and the detected failure has a higher priority than any other request; or a Ring – Automatic Protection Switching protocol request (R-APS, as defined in Y.1731) is received which has a higher priority than any other local request.

A link/node failure is detected by the nodes adjacent to the failure. These nodes block the failed link and report the failure to the ring using R-APS (SF) messages. This message triggers the RPL owner to unblock the RPL, and all nodes to flush their forwarding database. The ring is now in protection state, but it remains connected in a logical topology.

When the failed link recovers, the traffic is kept blocked on the nodes adjacent to the recovered link. The nodes adjacent to the recovered link transmit R-APS (NR - no request) message indicating they have no local request. When the RPL owner receives an R-APS (NR) message it starts the Wait-To-Recover (WTR) timer. Once WTR timer expires, the RPL owner blocks the RPL and transmits an R-APS (NR, RB - ring blocked) message. Nodes receiving this message flush the forwarding database and unblock their previously blocked ports. The ring is now returned to Idle state.

Figure 284: ERPS Ring Components

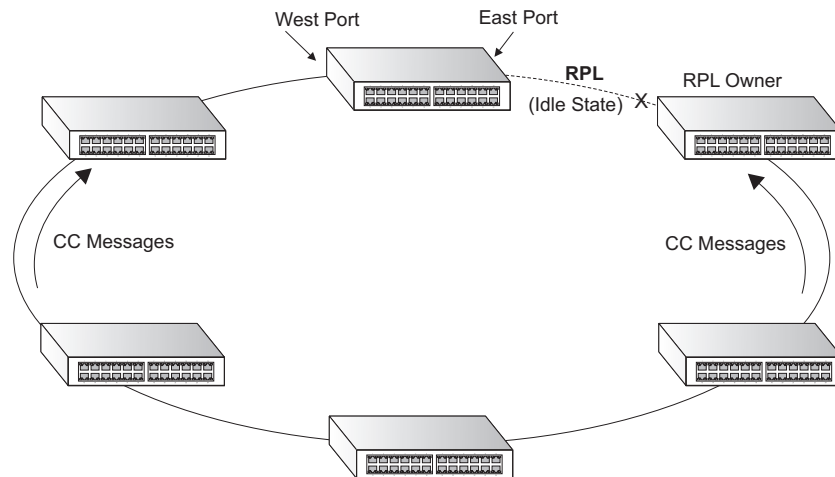

Multi-ring/Ladder Network – ERPSv2 also supports multipoint-to-multipoint connectivity within interconnected rings, called a “multi-ring/ladder network” topology. This arrangement consists of conjoined rings connected by one or more interconnection points, and is based on the following criteria:

- ◆ The R-APS channels are not shared across Ethernet Ring interconnections.
- ◆ On each ring port, each traffic channel and each R-APS channel are controlled (e.g., for blocking or flushing) by the Ethernet Ring Protection Control Process (ERP Control Process) of only one ring.
- ◆ Each Major Ring or Sub-Ring must have its own RPL.

[Figure 285 on page 498](#) (Normal Condition) depicts an example of a multi-ring/ladder network. If the network is in normal operating condition, the RPL owner node of each ring blocks the transmission and reception of traffic over the RPL for that ring. This figure presents the configuration when no failure exists on any ring link.

In the figure for the Normal Condition there are two interconnected rings. Ring ERP1 is composed of ring nodes A, B, C and D and the ring links between these nodes. Ring ERP2 is composed of ring nodes C, D, E and F and the ring links C-to-F, F-to-E, E-to-D. The ring link between D and C is used for traffic on rings ERP1 and ERP2. On their own ERP2 ring links do not form a closed loop. A closed loop may be formed by the ring links of ERP2 and the ring link between the interconnection nodes that is controlled by ERP1. ERP2 is a sub-ring. Ring node A is the RPL owner node for ERP1, and ring node E is the RPL owner node for ERP2. These ring nodes (A and E) are responsible for blocking the traffic channel on the RPL for ERP1 and ERP2 respectively. There is no restriction on which ring link on an ring may be set as the RPL. For example the RPL of ERP1 could be set as the link between ring node C and D.

Ring nodes C and D, that are common to both ERP1 and ERP2, are called interconnection nodes. The ring link between the interconnection nodes are controlled and protected by the ring it belongs to. In the example for the Normal Condition, the ring link between ring nodes C and D is part of ERP1, and, as such, are controlled and protected by ERP1. Ethernet characteristic information traffic corresponding to the traffic channel may be transferred over a common Ethernet connection for ERP1 and ERP2 through the interconnection nodes C and D. Interconnection nodes C and D have separate ERP Control Processes for each Ethernet Ring.

[Figure 285 on page 498](#) (Signal Fail Condition) illustrates a situation where protection switching has occurred due to an SF condition on the ring link between interconnection nodes C and D. The failure of this ring link triggers protection only on the ring to which it belongs, in this case ERP1. The traffic and R-APS channels are blocked bi-directionally on the ports where the failure is detected and bi-directionally unblocked at the RPL connection point on ERP1. The traffic channels remain bi-directionally blocked at the RPL connection point on ERP2. This prevents the formation of a loop.

Figure 285: Ring Interconnection Architecture (Multi-ring/Ladder Network)

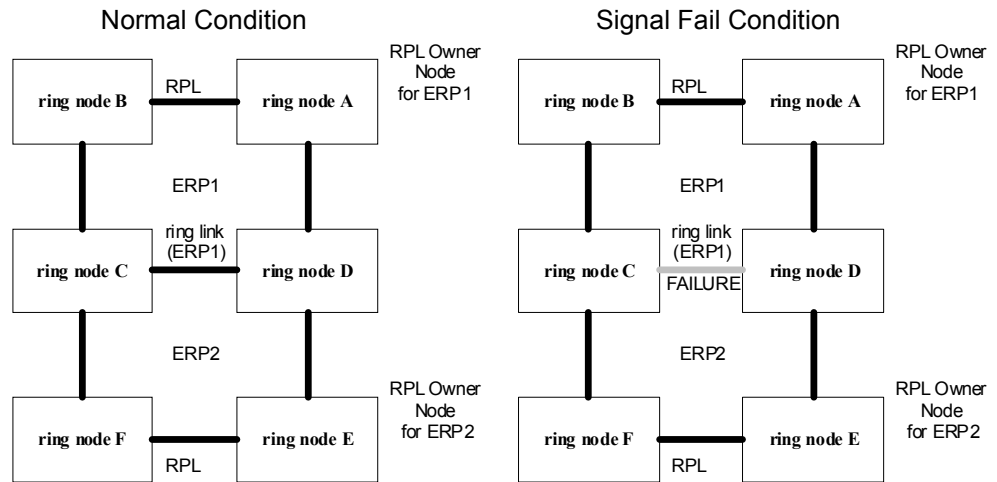

Configuration Guidelines for ERPS

1. Create an ERPS ring ([Configure Domain – Add](#)): The ring name is used as an index in the G.8032 database.
2. Configure the east and west interfaces ([Configure Domain – Configure Details](#)): Each node on the ring connects to it through two ring ports. Configure one port connected to the next node in the ring to the east (or clockwise direction) and another port facing west in the ring.
3. Configure the RPL owner ([Configure Domain – Configure Details](#)): Configure one node in the ring as the Ring Protection Link (RPL) owner. When this switch is configured as the RPL owner, the west ring port is set as being connected to the RPL. Under normal operations (Idle state), the RPL is blocked to ensure that a loop cannot form in the ring. If a signal failure brings down any other link in the ring, the RPL will be unblocked (Protection state) to ensure proper connectivity among all ring nodes until the failure is recovered.
4. Configure ERPS timers ([Configure Domain – Configure Details](#)): Set the Guard timer to prevent ring nodes from receiving outdated R-APS messages, the Hold-off timer to filter out intermittent link faults, and the WTR timer to verify that the ring has stabilized before blocking the RPL after recovery from a signal failure.
5. Configure the ERPS Control VLAN ([Configure Domain – Configure Details](#)): Specify the Control VLAN (CVLAN) used to pass R-APS ring maintenance commands. The CVLAN must NOT be configured with an IP address. In addition, only ring ports may be added to the CVLAN (prior to configuring the VLAN as a CVLAN). No other ports can be members of this VLAN (once set as a CVLAN). Also, the ring ports of the CVLAN must be tagged. Failure to observe these restrictions can result in a loop in the network.

6. Enable ERPS ([Configure Global](#)): Before enabling a ring as described in the next step, first globally enable ERPS on the switch. If ERPS has not yet been enabled or has been disabled, no ERPS rings will work.
7. Enable an ERPS ring ([Configure Domain – Configure Details](#)): Before an ERPS ring can work, it must be enabled. When configuration is completed and the ring enabled, R-APS messages will start flowing in the control VLAN, and normal traffic will begin to flow in the data VLANs. A ring can be stopped by disabling the Admin Status on any node.
8. Display ERPS status information ([Configure Domain – Show](#)): Display ERPS status information for all configured rings.

Configuration Limitations for ERPS

The following configuration limitations apply to ERPS:

- ◆ One switch supports up to 26 ERPS rings – each ring must have one Control VLAN, and at most 255 Data VLANs.
- ◆ Ring ports can not be a member of a trunk, nor an LACP-enabled port.
- ◆ Dynamic VLANs are not supported as protected data ports.
- ◆ Exclusive use of STP or ERPS on any port.
- ◆ The switch takes about 350 ms to detect link-up on 1000Base-T copper ports, so the convergence time on this port type is more than 50 ms.
- ◆ One VLAN must be added to an ERPS domain as the CVLAN. This can be designated as any VLAN, other than the management VLAN. The CVLAN should only contain ring ports, and must not be configured with an IP address.

ERPS GLOBAL CONFIGURATION Use the Administration > ERPS (Configure Global) page to globally enable or disable ERPS on the switch.

CLI REFERENCES

- ◆ ["erps" on page 1121](#)

PARAMETERS

These parameters are displayed:

- ◆ **ERPS Status** – Enables ERPS on the switch. (Default: Disabled)

WEB INTERFACE

To globally enable ERPS on the switch:

1. Click Administration, ERPS.
2. Select Configure Global from the Step list.

3. Mark the ERPS Status check box.
4. Click Apply.

Figure 286: Setting ERPS Global Status

The screenshot shows a web interface for configuring ERPS. At the top, it says 'Administration > ERPS'. Below that is a 'Step:' dropdown menu set to '1. Configure Global'. The main configuration area has 'ERPS Status' with a checked checkbox and the text 'Enabled'. At the bottom right, there are two buttons: 'Apply' and 'Revert'.

ERPS RING CONFIGURATION Use the Administration > ERPS (Configure Domain) pages to configure ERPS rings.

CLI REFERENCES

- ◆ ["ERPS Commands" on page 1119](#)

COMMAND USAGE

Ring Initialization

An ERPS ring containing one Control VLAN and one or more protected Data VLANs must be configured, and the global ERPS function enabled on the switch (see ["ERPS Global Configuration" on page 499](#)) before a ring can start running. Once enabled, the RPL owner node and non-owner node state machines will start, and the ring will enter the active state.

Limitations

When configuring a ring port, note that these ports cannot be part of a spanning tree, nor can they be members of a static or dynamic trunk.

PARAMETERS

These parameters are displayed:

Add

- ◆ **Domain Name** – Name of an ERPS ring. (Range: 1-12 characters)
- ◆ **Domain ID** – ERPS ring identifier used in R-APS messages. (Range: 1-255)

Show

- ◆ **Domain Name** – Name of a configured ERPS ring.
- ◆ **ID** – ERPS ring identifier used in R-APS messages.
- ◆ **Admin Status** – Shows whether ERPS is enabled on the switch.
- ◆ **Ver** – Shows the ERPS version.

- ◆ **MEG Level** – The maintenance entity group (MEG) level providing a communication channel for ring automatic protection switching (R-APS) information.
- ◆ **Control VLAN** – Shows the Control VLAN ID.
- ◆ **Node State** – Shows the following ERPS states:
 - Init – The ERPS ring has started but has not yet determined the status of the ring.
 - Idle – If all nodes in a ring are in this state, it means that all the links in the ring are up. This state will switch to protection state if a link failure occurs.
 - Protection – If a node in this state, it means that a link failure has occurred. This state will switch to idle state if all the failed links recover.
- ◆ **Type** – Shows node type as None, RPL Owner or RPL Neighbor.
- ◆ **Revertive** – Shows if revertive or non-revertive recovery is selected.
- ◆ **W/E** – Shows information on the west and east ring port for this node.
- ◆ **West Port** – Shows the west ring port for this node.
- ◆ **East Port** – Shows the east ring port for this node.
- ◆ **Interface** – The port or trunk which is configured as a ring port.
- ◆ **Port State** – The operational state:
 - Blocking – The transmission and reception of traffic is blocked and the forwarding of R-APS messages is blocked, but the transmission of locally generated R-APS messages is allowed and the reception of all R-APS messages is allowed.
 - Forwarding – The transmission and reception of traffic is allowed; transmission, reception and forwarding of R-APS messages is allowed.
 - Unknown – The interface is not in a known state (includes the domain being disabled).
- ◆ **Local SF** – A signal fault generated on a link to the local node.
- ◆ **Local FS** – Shows if a forced switch command was issued on this interface.
- ◆ **Local MS** – Shows if a manual switch command was issued on this interface.
- ◆ **MEP** – The CFM MEP used to monitor the status on this link.
- ◆ **RPL** – Shows if this node is connected to the RPL.

Configure Details

- ◆ **Domain Name** – Name of a configured ERPS ring. (Range: 1-12 characters)

Service Instances within each ring are based on a unique maintenance association for the specific users, distinguished by the ring name, maintenance level, maintenance association's name, and assigned VLAN. Up to 26 ERPS rings can be configured on the switch.

- ◆ **Domain ID** – ERPS ring identifier used in R-APS messages. (Range: 1-255; Default: None)

R-APS information is carried in an R-APS PDUs. The last octet of the MAC address is designated as the Ring ID (01-19-A7-00-00-[Ring ID]). If use of the default MAC address is disabled for the R-APS Def MAC parameter, then the Domain ID will be used in R-APS PDUs.

- ◆ **Admin Status** – Activates the current ERPS ring. (Default: Disabled)

Before enabling a ring, the global ERPS function should be enabled see ("[ERPS Global Configuration](#)" on page 499), the east and west ring ports configured on each node, the RPL owner specified, and the control VLAN configured.

Once enabled, the RPL owner node and non-owner node state machines will start, and the ring will enter idle state if no signal failures are detected.

- ◆ **Version** – Specifies compatibility with the following ERPS versions:
 - 1 - ERPS version 1 based on ITU-T G.8032/Y.1344.
 - 2 - ERPS version 2 based on ITU-T G.8032/Y.1344 Version 2. (This is the default setting.)

In addition to the basic features provided by version 1, version 2 also supports:

- Multi-ring/ladder network support
- Revertive/Non-revertive recovery
- Forced Switch (FS) and Manual Switch (MS) commands for manually blocking a particular ring port
- Flush FDB (forwarding database) logic which reduces amount of flush FDB operations in the ring
- Support of multiple ERP instances on a single ring

Version 2 is backward compatible with Version 1. If version 2 is specified, the inputs and commands are forwarded transparently. If set to version 1, MS and FS operator commands are filtered, and the switch set to revertive mode.

The version number is automatically set to "1" when a ring node, supporting only the functionalities of G.8032v1, exists on the same ring with other nodes that support G.8032v2.

When ring nodes running G.8032v1 and G.8032v2 co-exist on a ring, the ring ID of each node is configured as "1".

In version 1, the MAC address 01-19-A7-00-00-01 is used for the node identifier. The R-APS Def MAC parameter has no effect.

- ◆ **MEG Level** – The maintenance entity group (MEG) level which provides a communication channel for ring automatic protection switching (R-APS) information. (Range: 0-7)

This parameter is used to ensure that received R-APS PDUs are directed for this ring. A unique level should be configured for each local ring if there are many R-APS PDUs passing through this switch.

- ◆ **Control VLAN** – A dedicated VLAN used for sending and receiving E-APS protocol messages. (Range: 1-4094)

Configure one control VLAN for each ERPS ring. First create the VLAN to be used as the control VLAN (see ["Configuring VLAN Groups" on page 202](#)), add the ring ports for the east and west interface as tagged members to this VLAN (see ["Adding Static Members to VLANs" on page 205](#)), and then use this parameter to add it to the ring.

The following restrictions are recommended to avoid creating a loop in the network or other problems which may occur under some situations:

- The Control VLAN must not be configured as a Layer 3 interface (with an IP address), a dynamic VLAN (with GVRP enabled), nor as a private VLAN.
- In addition, only ring ports may be added to the Control VLAN. No other ports can be members of this VLAN.
- Also, the ring ports of the Control VLAN must be tagged.

Once the ring has been activated, the configuration of the control VLAN cannot be modified. Use the Admin Status parameter to stop the ERPS ring before making any configuration changes to the control VLAN.

- ◆ **Node State** – Refer to the parameters for the Show page.

- ◆ **Node Type** – Shows ERPS node type as one of the following:

- **None** – Node is neither Ring Protection Link (RPL) owner nor neighbor. (This is the default setting.)
- **RPL Owner** – Specifies a ring node to be the RPL owner.
 - Only one RPL owner can be configured on a ring. The owner blocks traffic on the RPL during Idle state, and unblocks it during Protection state (that is, when a signal fault is detected on the ring or the protection state is enabled with the Forced Switch or Manual Switch commands on the Configure Operation page).
 - The east and west connections to the ring must be specified for all ring nodes. When this switch is configured as the RPL owner, the west ring port is automatically set as being connected to the RPL.

- **RPL Neighbor** – Specifies a ring node to be the RPL neighbor.
 - The RPL neighbor node, when configured, is a ring node adjacent to the RPL that is responsible for blocking its end of the RPL under normal conditions (i.e., the ring is established and no requests are present in the ring) in addition to the block at the other end by the RPL Owner Node. The RPL neighbor node may participate in blocking or unblocking its end of the RPL, but is not responsible for activating the reversion behavior.
 - Only one RPL owner can be configured on a ring. If the switch is set as the RPL owner for an ERPS domain, the west ring port is set as one end of the RPL. If the switch is set as the RPL neighbor for an ERPS domain, the east ring port is set as the other end of the RPL.
 - The east and west connections to the ring must be specified for all ring nodes. When this switch is configured as the RPL neighbor, the east ring port is set as being connected to the RPL.
 - Note that is not mandatory to declare a RPL neighbor.
- ◆ **Revertive** – Sets the method of recovery to Idle State through revertive or non-revertive mode. (Default: Enabled)
 - Revertive behavior allows the switch to automatically return the RPL from Protection state to Idle state through the exchange of protocol messages.

Non-revertive behavior for Protection, Forced Switch (FS), and Manual Switch (MS) states are basically the same. Non-revertive behavior requires the RPL to be restored from Protection state to Idle state using the Clear command (Configure Operation page).
 - Recovery for Protection Switching – A ring node that has one or more ring ports in an SF (Signal Fail) condition, upon detecting the SF condition cleared, keeps at least one of its ring ports blocked for the traffic channel and for the R-APS channel, until the RPL is blocked as a result of ring protection reversion, or until there is another higher priority request (e.g., an SF condition) in the ring.

A ring node that has one ring port in an SF condition and detects the SF condition cleared, continuously transmits the R-APS (NR – no request) message with its own Node ID as the priority information over both ring ports, informing that no request is present at this ring node and initiates a guard timer. When another recovered ring node (or nodes) holding the link block receives this message, it compares the Node ID information with its own Node ID. If the received R-APS (NR) message has the higher priority, this ring node unblocks its ring ports. Otherwise, the block remains unchanged. As a result, there is only one link with one end blocked.

The ring nodes stop transmitting R-APS (NR) messages when they accept an R-APS (NR, RB – RPL Blocked), or when another higher priority request is received.

- Recovery with Revertive Mode – When all ring links and ring nodes have recovered and no external requests are active, reversion is handled in the following way:
 - a. The reception of an R-APS (NR) message causes the RPL Owner Node to start the WTR (Wait-to-Restore) timer.
 - b. The WTR timer is cancelled if during the WTR period a higher priority request than NR is accepted by the RPL Owner Node or is declared locally at the RPL Owner Node.
 - c. When the WTR timer expires, without the presence of any other higher priority request, the RPL Owner Node initiates reversion by blocking its traffic channel over the RPL, transmitting an R-APS (NR, RB) message over both ring ports, informing the ring that the RPL is blocked, and performing a flush FDB action.
 - d. The acceptance of the R-APS (NR, RB) message causes all ring nodes to unblock any blocked non-RPL link that does not have an SF condition. If it is an R-APS (NR, RB) message without a DNF (do not flush) indication, all ring nodes flush the FDB.

- Recovery with Non-revertive Mode – In non-revertive operation, the ring does not automatically revert when all ring links and ring nodes have recovered and no external requests are active. Non-revertive operation is handled in the following way:
 - a. The RPL Owner Node does not generate a response on reception of an R-APS (NR) messages.
 - b. When other healthy ring nodes receive the NR (Node ID) message, no action is taken in response to the message.
 - c. When the operator issues the Clear command (Configure Operation page) for non-revertive mode at the RPL Owner Node, the non-revertive operation is cleared, the RPL Owner Node blocks its RPL port, and transmits an R-APS (NR, RB) message in both directions, repeatedly.
 - d. Upon receiving an R-APS (NR, RB) message, any blocking node should unblock its non-failed ring port. If it is an R-APS (NR, RB) message without a DNF indication, all ring nodes flush the FDB.

- Recovery for Forced Switching – A Forced Switch command is removed by issuing the Clear command (Configure Operation page) to the same ring node where Forced Switch mode is in effect. The clear command removes any existing local operator commands, and triggers reversion if the ring is in revertive behavior mode.

The ring node where the Forced Switch was cleared continuously transmits the R-APS (NR) message on both ring ports, informing other nodes that no request is present at this ring node. The ring nodes stop transmitting R-APS (NR) messages when they

accept an RAPS (NR, RB) message, or when another higher priority request is received.

If the ring node where the Forced Switch was cleared receives an R-APS (NR) message with a Node ID higher than its own Node ID, it unblocks any ring port which does not have an SF condition and stops transmitting R-APS (NR) message over both ring ports.

- Recovery with revertive mode is handled as follows:
 - a. The reception of an R-APS (NR) message causes the RPL Owner Node to start the WTB timer.
 - b. The WTB timer is cancelled if during the WTB period a higher priority request than NR is accepted by the RPL Owner Node or is declared locally at the RPL Owner Node.
 - c. When the WTB timer expires, in the absence of any other higher priority request, the RPL Owner Node initiates reversion by blocking the traffic channel over the RPL, transmitting an R-APS (NR, RB) message over both ring ports, informing the ring that the RPL is blocked, and flushes the FDB.
 - d. The acceptance of the R-APS (NR, RB) message causes all ring nodes to unblock any blocked non-RPL that does not have an SF condition. If it is an R-APS (NR, RB) message without a DNF indication, all ring nodes flush their FDB. This action unblocks the ring port which was blocked as a result of an operator command.
- Recovery with non-revertive mode is handled as follows:
 - a. The RPL Owner Node, upon reception of an R-APS(NR) message and in the absence of any other higher priority request does not perform any action.
 - b. Then, after the operator issues the Clear command (Configure Operation page) at the RPL Owner Node, this ring node blocks the ring port attached to the RPL, transmits an R-APS (NR, RB) message on both ring ports, informing the ring that the RPL is blocked, and flushes its FDB.
 - c. The acceptance of the R-APS (NR, RB) message triggers all ring nodes to unblock any blocked non-RPL which does not have an SF condition. If it is an R-APS (NR, RB) message without a DNF indication, all ring nodes flush their FDB. This action unblocks the ring port which was blocked as result of an operator command.
- Recovery for Manual Switching – A Manual Switch command is removed by issuing the Clear command (Configure Operation page) at the same ring node where the Manual Switch is in effect. The clear command removes any existing local operator

commands, and triggers reversion if the ring is in revertive behavior mode.

The ring node where the Manual Switch was cleared keeps the ring port blocked for the traffic channel and for the R-APS channel, due to the previous Manual Switch command. This ring port is kept blocked until the RPL is blocked as a result of ring protection reversion, or until there is another higher priority request (e.g., an SF condition) in the ring.

The Ethernet Ring Node where the Manual Switch was cleared continuously transmits the R-APS (NR) message on both ring ports, informing that no request is present at this ring node. The ring nodes stop transmitting R-APS (NR) messages when they accept an RAPS (NR, RB) message, or when another higher priority request is received.

If the ring node where the Manual Switch was cleared receives an R-APS (NR) message with a Node ID higher than its own Node ID, it unblocks any ring port which does not have an SF condition and stops transmitting R-APS (NR) message on both ring ports.

- Recovery with revertive mode is handled as follows:
 - a. The RPL Owner Node, upon reception of an R-APS (NR) message and in the absence of any other higher priority request, starts the WTB timer and waits for it to expire. While the WTB timer is running, any latent R-APS (MS) message is ignored due to the higher priority of the WTB running signal.
 - b. When the WTB timer expires, it generates the WTB expire signal. The RPL Owner Node, upon reception of this signal, initiates reversion by blocking the traffic channel on the RPL, transmitting an R-APS (NR, RB) message over both ring ports, informing the ring that the RPL is blocked, and flushes its FDB.
 - c. The acceptance of the R-APS (NR, RB) message causes all ring nodes to unblock any blocked non-RPL that does not have an SF condition. If it is an R-APS (NR, RB) message without a DNF indication, all Ethernet Ring Nodes flush their FDB. This action unblocks the ring port which was blocked as a result of an operator command.

- Recovery with non-revertive mode is handled as follows:
 - a. The RPL Owner Node, upon reception of an R-APS (NR) message and in the absence of any other higher priority request does not perform any action.
 - b. Then, after the operator issues the Clear command (Configure Operation page) at the RPL Owner Node, this ring node blocks the ring port attached to the RPL, transmits an R-APS (NR, RB) message over both ring ports, informing the ring that the RPL is blocked, and flushes its FDB.

- c. The acceptance of the R-APS (NR, RB) message triggers all ring nodes to unblock any blocked non-RPL which does not have an SF condition. If it is an R-APS (NR, RB) message without a DNF indication, all ring nodes flush their FDB. This action unblocks the ring port which was blocked as result of an operator command.

- ◆ **Major Domain** – The ERPS ring used for sending control packets.

This switch can support up to six rings. However, ERPS control packets can only be sent on one ring. This parameter is used to indicate that the current ring is a secondary ring, and to specify the major ring which will be used to send ERPS control packets.

The Ring Protection Link (RPL) is always the west port. So the physical port on a secondary ring must be the west port. In other words, if a domain has two physical ring ports, this ring can only be a major ring, not a secondary ring (or sub-domain) which can have only one physical ring port. The major domain therefore cannot be set if the east port is already configured.

- ◆ **Node ID** – A MAC address unique to the ring node. The MAC address must be specified in the format xx-xx-xx-xx-xx-xx or xxxxxxxxxxxx. (Default: CPU MAC address)

The ring node identifier is used to identify a node in R-APS messages for both automatic and manual switching recovery operations.

For example, a node that has one ring port in SF condition and detects that the condition has been cleared, will continuously transmit R-APS (NR) messages with its own Node ID as priority information over both ring ports, informing its neighbors that no request is present at this node. When another recovered node holding the link blocked receives this message, it compares the Node ID information with its own. If the received R-APS (NR) message has a higher priority, this unblocks its ring ports. Otherwise, the block remains unchanged.

The node identifier may also be used for debugging, such as to distinguish messages when a node is connected to more than one ring.

- ◆ **R-APS with VC** – Configures an R-APS virtual channel to connect two interconnection points on a sub-ring, allowing ERPS protocol traffic to be tunneled across an arbitrary Ethernet network. (Default: Enabled)

- A sub-ring may be attached to a primary ring with or without a virtual channel. A virtual channel is used to connect two interconnection points on the sub-ring, tunneling R-APS control messages across an arbitrary Ethernet network topology. If a virtual channel is not used to cross the intermediate Ethernet network, data in the traffic channel will still flow across the network, but the all R-APS messages will be terminated at the interconnection points.
- Sub-ring with R-APS Virtual Channel – When using a virtual channel to tunnel R-APS messages between interconnection points on a sub-ring, the R-APS virtual channel may or may not follow the same path as the traffic channel over the network. R-APS messages that

are forwarded over the sub-ring's virtual channel are broadcast or multicast over the interconnected network. For this reason the broadcast/multicast domain of the virtual channel should be limited to the necessary links and nodes. For example, the virtual channel could span only the interconnecting rings or sub-rings that are necessary for forwarding R-APS messages of this sub-ring. Care must also be taken to ensure that the local RAPS messages of the sub-ring being transported over the virtual channel into the interconnected network can be uniquely distinguished from those of other interconnected ring R-APS messages. This can be achieved by, for example, by using separate VIDs for the virtual channels of different sub-rings.

Note that the R-APS virtual channel requires a certain amount of bandwidth to forward R-APS messages on the interconnected Ethernet network where a sub-ring is attached. Also note that the protection switching time of the sub-ring may be affected if R-APS messages traverse a long distance over an R-APS virtual channel.

Figure 287: Sub-ring with Virtual Channel

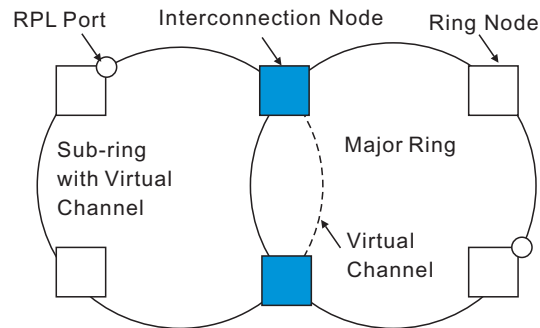

- Sub-ring without R-APS Virtual Channel – Under certain circumstances it may not be desirable to use a virtual channel to interconnect the sub-ring over an arbitrary Ethernet network. In this situation, the R-APS messages are terminated on the interconnection points. Since the sub-ring does not provide an R-APS channel nor R-APS virtual channel beyond the interconnection points, R-APS channel blocking is not employed on the normal ring links to avoid channel segmentation. As a result, a failure at any ring link in the sub-ring will cause the R-APS channel of the sub-ring to be segmented, thus preventing R-APS message exchange between some of the sub-ring's ring nodes.

No R-APS messages are inserted or extracted by other rings or sub-rings at the interconnection nodes where a sub-ring is attached. Hence there is no need for either additional bandwidth or for different VIDs/Ring IDs for the ring interconnection. Furthermore, protection switching time for a sub-ring is independent from the configuration or topology of the interconnected rings. In addition, this option always ensures that an interconnected network forms a tree topology regardless of its interconnection configuration. This means that it is not necessary to take precautions against forming a loop which is potentially composed of a whole interconnected network.

Figure 288: Sub-ring without Virtual Channel

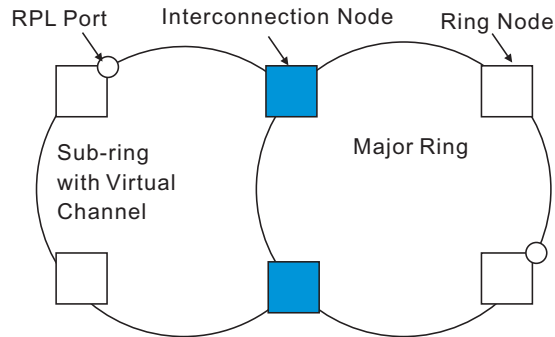

- ◆ **R-APS Def MAC** – Sets the switch’s MAC address to be used as the node identifier in R-APS messages. (Default: Enabled)

When ring nodes running ERPSv1 and ERPSv2 co-exist on the same ring, the Ring ID of each ring node must be configured as “1”.

If this command is disabled, the following strings are used as the node identifier:

- ERPSv1: 01-19-A7-00-00-01
- ERPSv2: 01-19-A7-00-00-[Ring ID]

- ◆ **Propagate TC** – Enables propagation of topology change messages from a secondary ring to the primary ring. (Default: Disabled)

When a secondary ring detects a topology change, it can pass a message about this event to the major ring. When the major ring receives this kind of message from a secondary ring, it can clear the MAC addresses on its ring ports to help the secondary ring restore its connections more quickly through protection switching.

When the MAC addresses are cleared, data traffic may flood onto the major ring. The data traffic will become stable after the MAC addresses are learned again. The major ring will not be broken, but the bandwidth of data traffic on the major ring may suffer for a short period of time due to this flooding behavior.

- ◆ **Non-ERPS Device Protection** – Sends non-standard health-check packets when an owner node enters protection state without any link down event having been detected through Signal Fault messages. (Default: Disabled)
 - The RPL owner node detects a failed link when it receives R-APS (SF - signal fault) messages from nodes adjacent to the failed link. The owner then enters protection state by unblocking the RPL. However, using this standard recovery procedure may cause a non-ERPS device to become isolated when the ERPS device adjacent to it detects a continuity check message (CCM) loss event and blocks the link between the non-ERPS device and ERPS device.

CCMs are propagated by the Connectivity Fault Management (CFM) protocol as described under "[Connectivity Fault Management](#)" on [page 520](#). If the standard recovery procedure were used as shown

in the following figure, and node E detected CCM loss, it would send an R-APS (SF) message to the RPL owner and block the link to node D, isolating that non-ERPS device.

Figure 289: Non-ERPS Device Protection

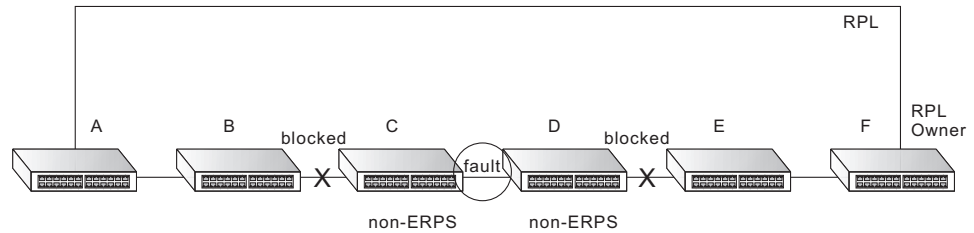

When non-ERPS device protection is enabled on the ring, the ring ports on the RPL owner node and non-owner nodes will not be blocked when signal loss is detected by CCM loss events.

- When non-ERPS device protection is enabled on an RPL owner node, it will send non-standard health-check packets to poll the ring health when it enters the protection state. It does not use the normal procedure of waiting to receive an R-APS (NR - no request) message from nodes adjacent to the recovered link. Instead, it waits to see if the non-standard health-check packets loop back. If they do, indicating that the fault has been resolved, the RPL will be blocked.

After blocking the RPL, the owner node will still transmit an R-APS (NR, RB - ring blocked) message. ERPS-compliant nodes receiving this message flush their forwarding database and unblock previously blocked ports. The ring is now returned to Idle state.

- ◆ **Holdoff Timer** – The hold-off timer is used to filter out intermittent link faults. Faults will only be reported to the ring protection mechanism if this timer expires. (Range: 0-10000 milliseconds, in steps of 100 milliseconds)

In order to coordinate timing of protection switches at multiple layers, a hold-off timer may be required. Its purpose is to allow, for example, a server layer protection switch to have a chance to fix the problem before switching at a client layer.

When a new defect or more severe defect occurs (new Signal Failure), this event will not be reported immediately to the protection switching mechanism if the provisioned hold-off timer value is non-zero. Instead, the hold-off timer will be started. When the timer expires, whether a defect still exists or not, the timer will be checked. If one does exist, that defect will be reported to the protection switching mechanism. The reported defect need not be the same one that started the timer.

- ◆ **Guard Timer** – The guard timer is used to prevent ring nodes from receiving outdated R-APS messages. During the duration of the guard timer, all received R-APS messages are ignored by the ring protection control process, giving time for old messages still circulating on the ring to expire. (Range: 10-2000 milliseconds, in steps of 10 milliseconds)

The guard timer duration should be greater than the maximum expected forwarding delay for an R-APS message to pass around the

ring. A side-effect of the guard timer is that during its duration, a node will be unaware of new or existing ring requests transmitted from other nodes.

- ◆ **WTB Timer** – The Wait to Block (WTB) timer is used when clearing Forced Switch (FS) and Manual Switch (MS) commands. As multiple FS commands are allowed to co-exist in a ring, the WTB timer ensures that clearing of a single FS command does not trigger re-blocking of the RPL. When clearing an MS command, the WTB timer prevents the formation of a closed loop due to possible a timing anomaly where the RPL owner node receives an outdated remote MS request during the recovery process.

When recovering from an FS or MS command, the delay timer must be long enough to receive any latent remote FS or MS commands. This delay timer called the WTB timer is defined to be 5 seconds longer than the guard timer. This is enough time to allow a reporting ring node to transmit two R-APS messages and allow the ring to identify the latent condition.

This delay timer is activated on the RPL owner node. When the relevant delay timer expires, the RPL owner node initiates the reversion process by transmitting an R-APS (NR, RB) message. The delay timer, (i.e., WTR or WTB) is deactivated when any higher priority request preempts this delay timer.

The delay timers (i.e. WTR and WTB) may be started and stopped by the system. A request to start running the delay timer does not restart the delay timer. A request to stop the delay timer stops the delay timer and resets its value. The Clear command (Configure Operation page) can be used to stop the delay timer.

- ◆ **WTR Timer** – The wait-to-restore timer is used to verify that the ring has stabilized before blocking the RPL after recovery from a signal failure. (Range: 5-12 minutes)

If the switch goes into ring protection state due to a signal failure, after the failure condition is cleared, the RPL owner will start the wait-to-restore timer and wait until it expires to verify that the ring has stabilized before blocking the RPL and returning to the Idle (normal operating) state.

- ◆ **WTB Expire** – The time before the wait-to-block timer expires.
- ◆ **WTR Expire** – The time before the wait-to-restore timer expires.
- ◆ **West/East** – Connects to next ring node to the west/east.

Each node must be connected to two neighbors on the ring. For convenience, the ports connected are referred to as east and west ports. Alternatively, the closest neighbor to the east should be the next node in the ring in a clockwise direction, and the closest neighbor to the west should be the next node in the ring in a counter-clockwise direction.

- ◆ **Interface** – The port or trunk attached to the west or east ring port.

Note that a ring port cannot be configured as a member of a spanning tree, a dynamic trunk, or a static trunk.

- ◆ **Port State** – Once configured, this field shows the operational state of the ring ports for this node:
 - Blocking – The transmission and reception of traffic is blocked and the forwarding of R-APS messages is blocked, but the transmission of locally generated R-APS messages is allowed and the reception of all R-APS messages is allowed.
 - Forwarding – The transmission and reception of traffic is allowed; transmission, reception and forwarding of R-APS messages is allowed.
 - Unknown – The interface is not in a known state.
- ◆ **Local SF** – Shows if a signal fault exists on a link to the local node.
- ◆ **Local FS** – Shows if a forced switch command was issued on this interface.
- ◆ **Local MS** – Shows if a manual switch command was issued on this interface.
- ◆ **MEP** – Specifies the CCM MEPs used to monitor the link on a ring node.

If a MEP is used to monitor the link status of an ERPS node with CFM continuity check messages, then the MEG Level parameter on this configuration page must match the authorized maintenance level of the CFM domain to which the specified MEP belongs. (See "[Configuring CFM Maintenance Domains](#)" on page 527.)

To ensure complete monitoring of a ring node, specify the CFM MEPs used to monitor both the east and west ports of the ring node.

If CFM determines that a MEP node which has been configured to monitor a ring port with this command has gone down, this information is passed to ERPS, which in turn processes it as a ring node failure. For more information on how ERPS recovers from a node failure, refer to the description of the Revertive parameter on this configuration page.

- ◆ **RPL** – If node is connected to the RPL, this shows by which interface.

WEB INTERFACE

To create an ERPS ring:

1. Click Administration, ERPS.
2. Select Configure Domain from the Step list.
3. Select Add from the Action list.
4. Enter a name and optional identifier for the ring.

5. Click Apply.

Figure 290: Creating an ERPS Ring

The screenshot shows a web-based configuration interface for ERPS. At the top, it says "Administration > ERPS". Below that, there are two dropdown menus: "Step:" with "2. Configure Domain" selected, and "Action:" with "Add" selected. Underneath, there are two input fields: "Domain Name" with the text "rd1" entered, and "Domain ID (1-255)" with a checked checkbox and the number "1" entered. At the bottom right of the form, there are two buttons: "Apply" and "Revert".

To configure the ERPS parameters for a ring:

1. Click Administration, ERPS.
2. Select Configure Domain from the Step list.
3. Select Configure Details from the Action list.
4. Configure the ERPS parameters for this node. Note that spanning tree protocol cannot be configured on the ring ports, nor can these ports be members of a static or dynamic trunk. And the control VLAN must be unique for each ring. Adjust the protocol timers as required. The RPL owner must be set on one of the rings. And the administrative status enabled once all of the other settings have been entered.
5. Click Apply.

Figure 291: Creating an ERPS Ring

The screenshot shows the 'Administration > ERPS' configuration page. The 'Step' is '2. Configure Domain' and the 'Action' is 'Configure Details'. The configuration includes:

- Domain Name: rd1
- Domain ID: 1
- Admin Status: Enabled
- Version: 2
- MEG Level (0-7): 1
- Control VLAN: 2
- Node State: Idle
- Node Type: RPL Owner
- Revertive: Enabled
- Major Domain: []
- Node ID: 00-E0-0C-00-00-FD
- R-APS with VC: Enabled
- R-APS Def MAC: Enabled
- Propagate TC: Enabled
- Non-ERPS Dev Protect: Enabled
- Holdoff Timer (0-10000): 0 ms
- Guard Timer (10-2000): 500 ms
- WTB Timer: 5500 ms
- WTR Timer (5-12): 5 min
- WTB Expire: []
- WTR Expire: []
- West: Enabled
 - Interface: Eth 1/10
 - Port State: Blocking
 - Local SF: No
 - Local FS: No
 - Local MS: No
 - MEP (1-8191): []
 - RPL: Yes
- East: Enabled
 - Interface: Eth 1/12
 - Port State: Forwarding
 - Local SF: No
 - Local FS: No
 - Local MS: No
 - MEP (1-8191): []
 - RPL: No

Buttons: Apply, Revert

To show the configured ERPS rings:

1. Click Administration, ERPS.
2. Select Configure Domain from the Step list.
3. Select Show from the Action list.

Figure 292: Showing Configured ERPS Rings

The screenshot shows the 'Administration > ERPS' configuration page with the 'Step' set to '2. Configure Domain' and the 'Action' set to 'Show'. Below the configuration fields is a 'Domain List' table with the following data:

	Domain Name	ID	Admin Status	Ver	MEG Level	Control VLAN	Node State	Type	Revertive	W/E	Interface	Port State	Local SF	Local FS	Local MS	MEP	RPL
<input type="checkbox"/>	rd1	1	Enabled	2	1	2	Idle	RPL Owner	Yes	West	Eth 1/10	Blocking	No	No	No	Yes	Yes
										East	Eth 1/12	Forwarding	No	No	No	No	No

Buttons: Delete, Revert

ERPS FORCED AND MANUAL MODE OPERATIONS

Use the Administration > ERPS (Configure Operation) page to block a ring port using Forced Switch or Manual Switch commands.

CLI REFERENCES

- ◆ "erps forced-switch" on page 1141
- ◆ "erps manual-switch" on page 1143
- ◆ "erps clear" on page 1140

PARAMETERS

These parameters are displayed:

- ◆ **Domain Name** – Name of a configured ERPS ring.
- ◆ **Operation** – Specifies a Forced Switch (FS) or Manual Switch (MS) operation on the east or west ring port.
 - **Forced Switch** – Blocks specified ring port. (Options: West or East)
 - A ring with no pending request has a logical topology with the traffic channel blocked at the RPL and unblocked on all other ring links. In this situation, the FS command triggers protection switching as follows:
 - a. The ring node where an FS command was issued blocks the traffic channel and R-APS channel on the ring port to which the command was issued, and unblocks the other ring port.
 - b. The ring node where the FS command was issued transmits R-APS messages indicating FS over both ring ports. R-APS (FS) messages are continuously transmitted by this ring node while the local FS command is the ring node's highest priority command (see [Table 35 on page 517](#)). The R-APS (FS) message informs other ring nodes of the FS command and that the traffic channel is blocked on one ring port.
 - c. A ring node accepting an R-APS (FS) message, without any local higher priority requests unblocks any blocked ring port. This action subsequently unblocks the traffic channel over the RPL.
 - d. The ring node accepting an R-APS (FS) message, without any local higher priority requests stops transmission of R-APS messages.
 - e. The ring node receiving an R-APS (FS) message flushes its FDB.
 - Protection switching on a forced switch request is completed when the above actions are performed by each ring node. At this point, traffic flows around the ring are resumed. From this point on the following rules apply regarding processing of further forced switch commands:
 - While an existing forced switch request is present in a ring, any new forced switch request is accepted, except on a ring node having a prior local forced switch request. The ring

nodes where further forced switch commands are issued block the traffic channel and R-APS channel on the ring port at which the forced switch was issued. The ring node where the forced switch command was issued transmits an R-APS message over both ring ports indicating FS. R-APS (FS) messages are continuously transmitted by this ring node while the local FS command is the ring node's highest priority command. As such, two or more forced switches are allowed in the ring, which may inadvertently cause the segmentation of a ring. It is the responsibility of the operator to prevent this effect if it is undesirable.

Ring protection requests, commands and R-APS signals have the priorities as specified in the following table.

Table 35: ERPS Request/State Priority

Request / State and Status	Type	Priority
Clear	local	highest
FS	local	
R-APS (FS)	remote	
local SF*	local	
local clear SF	local	
R-APS (SF)	remote	
R-APS (MS)	remote	
MS	local	
WTR Expires	local	
WTR Running	local	
WTB Expires	local	
WTB Running	local	
R-APS (NR, RB)	remote	
R-APS (NR)	remote	lowest

* If an Ethernet Ring Node is in the Forced Switch state, local SF is ignored.

- Recovery for forced switching under revertive and non-revertive mode is described under the Revertive parameter.
- When a ring is under an FS condition, and the node at which an FS command was issued is removed or fails, the ring remains in FS state because the FS command can only be cleared at node where the FS command was issued. This results in an unrecoverable FS condition.

When performing a maintenance procedure (e.g., replacing, upgrading) on a ring node (or a ring link), it is recommended that FS commands be issued at the two adjacent ring nodes instead of directly issuing a FS command at the ring node

under maintenance in order to avoid falling into the above mentioned unrecoverable situation.

- **Manual Switch** – Blocks specified ring port, in the absence of a failure or an FS command. (Options: West or East)
 - A ring with no request has a logical topology with the traffic channel blocked at the RPL and unblocked on all other ring links. In this situation, the Manual Switch command triggers protection switching as follows:
 - a. If no other higher priority commands exist, the ring node, where a manual switch command was issued, blocks the traffic channel and R-APS channel on the ring port to which the command was issued, and unblocks the other ring port.
 - b. If no other higher priority commands exist, the ring node where the manual switch command was issued transmits R-APS messages over both ring ports indicating MS. R-APS (MS) message are continuously transmitted by this ring node while the local MS command is the ring node's highest priority command (see [Table 35 on page 517](#)). The R-APS (MS) message informs other ring nodes of the MS command and that the traffic channel is blocked on one ring port.
 - c. If no other higher priority commands exist and assuming the ring node was in Idle state before the manual switch command was issued, the ring node flushes its local FDB.
 - d. A ring node accepting an R-APS (MS) message, without any local higher priority requests unblocks any blocked ring port which does not have an SF condition. This action subsequently unblocks the traffic channel over the RPL.
 - e. A ring node accepting an R-APS (MS) message, without any local higher priority requests stops transmitting R-APS messages.
 - f. A ring node receiving an R-APS (MS) message flushes its FDB.
 - Protection switching on a manual switch request is completed when the above actions are performed by each ring node. At this point, traffic flows around the ring are resumed. From this point on, the following rules apply regarding processing of further manual switch commands:
 - a. While an existing manual switch request is present in the ring, any new manual switch request is rejected. The request is rejected at the ring node where the new request is issued and a notification is generated to inform the operator that the new MS request was not accepted.
 - b. A ring node with a local manual switch command which receives an R-APS (MS) message with a different Node ID clears its manual switch request and starts transmitting R-APS (NR) messages. The ring node keeps the ring port blocked due to the previous manual switch command.

- c. An ring node with a local manual switch command that receives an R-APS message or a local request of higher priority than R-APS (MS) clear its manual switch request. The ring node then processes the new higher priority request.
- Recovery for manual switching under revertive and non-revertive mode is described under the Revertive parameter.
- **Clear** – Manually clears the protection state which has been invoked by a forced switch or manual switch command, and the node is operating under non-revertive mode; or before the WTR or WTB timer expires when the node is operating in revertive mode.
- Two steps are required to make a ring operating in non-revertive mode return to Idle state from forced switch or manual switch state:
 1. Issue a Clear command to remove the forced switch command on the node where a local forced switch command is active.
 2. Issue a Clear command on the RPL owner node to trigger the reversion.
- The Clear command will also stop the WTR and WTB delay timers and reset their values.
- More detailed information about using this command for non-revertive mode is included under the Revertive parameter. (See the Command Usage section under ["ERPS Ring Configuration" on page 500.](#))

WEB INTERFACE

To block a ring port:

1. Click Administration, ERPS.
2. Select Configure Domain from the Step list.
3. Select Configure Operation from the Action list.
4. Select the domain name from the drop-down list.
5. Specify a Forced Switch, Manual Switch, or Clear operation.
6. Click Apply.

Figure 293: Blocking an ERPS Ring Port

Administration > ERPS

Step: 2. Configure Domain Action: Configure Operation

Domain Name: rd1

Operation: Clear

Apply Revert

CONNECTIVITY FAULT MANAGEMENT

Connectivity Fault Management (CFM) is an OAM protocol that includes proactive connectivity monitoring using continuity check messages, fault verification through loop back messages, and fault isolation by examining end-to-end connections between provider edge devices or between customer edge devices.

CFM is implemented as a service level protocol based on service instances which encompass only that portion of the metropolitan area network supporting a specific customer. CFM can also provide controlled management access to a hierarchy of maintenance domains (such as the customer, service provider, and equipment operator).

This switch supports functions for defining the CFM structure, including domains, maintenance associations, and maintenance access points. It also supports fault detection through continuity check messages for all known maintenance points, and cross-check messages which are used to verify a static list of remote maintenance points located on other devices (in the same maintenance association) against those found through continuity check messages. Fault verification is supported using loop back messages, and fault isolation with link trace messages. Fault notification is also provided by SNMP alarms which are automatically generated by maintenance points when connectivity faults or configuration errors are detected in the local maintenance domain.

Key Components of CFM

CFM provides restricted management access to each Service Instance using a structured conceptual network based on these components:

- ◆ A Maintenance Domain defines a part of the network controlled by a single operator, and supports management access to the domain through Domain Service Access Points (DSAPs) configured on the domain boundary, as well as connectivity testing between these DSAPs.
- ◆ A Maintenance Association (MA) contains the DSAPs for an individual Service Instance. DSAPs are the primary maintenance points used to monitor connectivity across a maintenance domain, and are the entry points to the paths which interconnect the access points allocated to a service instance.

- ◆ A Maintenance Level allows maintenance domains to be nested in a hierarchical fashion, providing access to the specific network portions required by each operator. Domains at lower levels may be either hidden or exposed to operators managing domains at a higher level, allowing either coarse or fine fault resolution.
- ◆ Maintenance End Points (MEPs) which provide full CFM access to a Service Instance (i.e., a specific MA), and Maintenance Intermediate Points (MIPs) which are passive entities that merely validate received CFM messages, or respond to link trace and loop back requests. MIPs are the interconnection points that make up all possible paths between the DSAPs within an MA, and may also include interconnection points in lower-level domains if exposed by CFM settings.

The following figure shows a single Maintenance Domain, with DSAPs located on the domain boundary, and Internal Service Access Points (ISAPs) inside the domain through which frames may pass between the DSAPs.

Figure 294: Single CFM Maintenance Domain

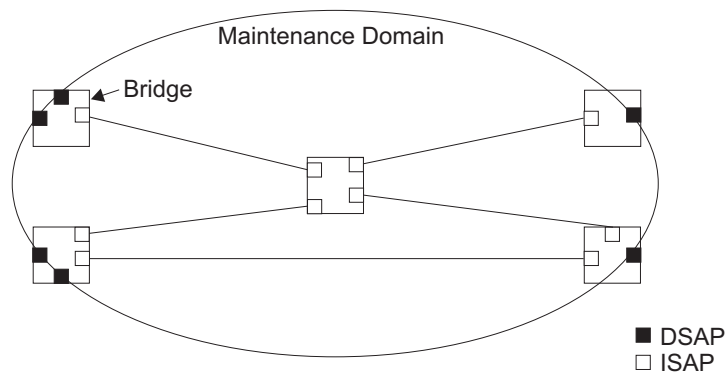

The figure below shows four maintenance associations contained within a hierarchical structure of maintenance domains. At the innermost level, there are two operator domains which include access points marked "O₁" and "O₂" respectively. The users of these domains can see their respective MEPs as well as all the MIPs within their domains. There is a service provider domain at the second level in the hierarchy. From the service provider's view, the access points marked "P" are visible, and all access points within the operator domains have also been made visible as MIPs according to common practice. And finally, there is a customer domain at the top of the hierarchy. Users at this level can only see the access points marked "C" on the outer domain boundary. Again, normal practice is to hide the internal structure of the network from outsiders to reduce security risks.

Figure 295: Multiple CFM Maintenance Domains

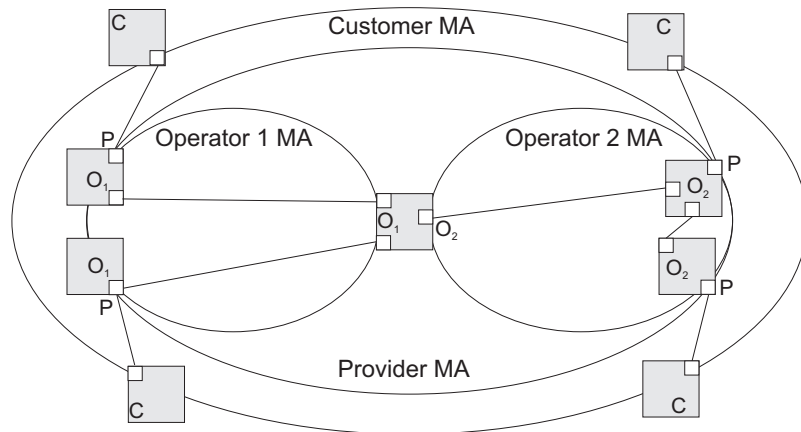

Note that the Service Instances within each domain shown above are based on a unique maintenance association for the specific users, distinguished by the domain name, maintenance level, maintenance association's name, and assigned VLAN.

Basic CFM Operations

CFM uses standard Ethernet frames for sending protocol messages. Both the source and destination address for these messages are based on unicast or multicast MAC addresses, and therefore confined to a single Layer 2 CFM service VLAN. For this reason, the transmission, forwarding, and processing of CFM frames is performed by bridges, not routers. Bridges that do not recognize CFM messages forward them as normal data. There are three basic types of CFM messages, including continuity check, link trace, and loop back.

Continuity check messages (CCMs) are multicast within a single Service Instance (i.e., a specific MA), allowing MEPs to discover other MEPs within the same MA, and MIPs to discover MEPs. Connectivity faults are indicated when a known MEP stops sending CCMs, or a remote MEP configured in a static list does not come up. Configuration errors, such as a cross-connect between different MAs, are indicated when a CCM is received with an incorrect MA identifier or maintenance level.

Loop back messages are used for fault verification. These messages can be sent using the MAC address of any destination MEP within the same MA. If the target MEP's identifier has been discovered through CCM messages, then a loop back message can also be sent using the MEPs identifier. A reply indicates that the destination is reachable.

Link trace messages are used for fault verification. These messages are multicast frames sent out to track the hop-by-hop path to a target MEP within the same MA. Responses provide information on the ingress, egress, and relay action taken at each hop along the path, providing vital information about connectivity problems. Responses allow the sender to discover all of the maintenance points that would be traversed by a data frame sent to the target MAC address.

SNMP traps can also be configured to provide an automated method of fault notification. If the fault notification generator detects one or more defects within the configured time period, and fault alarms are enabled, a corresponding trap will be sent. No further fault alarms are sent until the fault notification generator has been reset by the passage of a configured time period without detecting any further faults. Upon receiving a fault alarm, you should inspect the related SNMP objects for the reporting MEP, diagnose the fault, correct it, and re-examine the MEP's SNMP objects to see whether the fault notification generator has been reset.

Configuration Guidelines

1. Configure the maintenance domains with the MD List (see "[Configuring CFM Maintenance Domains](#)").
2. Configure the maintenance associations with MA List (see "[Configuring CFM Maintenance Associations](#)").
3. Configure the local maintenance end points (MEPs) which will serve as the domain service access points for the specified maintenance association using the MEP List (see "[Configuring CFM Maintenance Associations](#)").
4. Enter a static list of MEPs assigned to other devices within the same maintenance association using the Remote MEP List (see "[Configuring Remote Maintenance End Points](#)"). This allows CFM to automatically verify the functionality of these remote end points by cross-checking the static list configured on this device against information learned through continuity check messages.
5. Enable CFM globally on the switch using the Configure Global screen (see "[Configuring Global Settings for CFM](#)").
6. Enable CFM on the local MEPs using the Configure Interface screen (see "[Configuring Interfaces for CFM](#)").
7. Enable continuity check and cross-check operations, and configure AIS parameters using the Configure MA – Configure Details screen (see "[Configuring CFM Maintenance Associations](#)").

Other configuration changes may be required for your particular environment, such as adjusting the interval at which continuity check messages are sent (see "[Configuring CFM Maintenance Associations](#)"), or setting the start-up delay for the cross-check operation (see "[Configuring Global Settings for CFM](#)"). You can also enable SNMP traps for events discovered by continuity check messages or cross-check messages (see "[Configuring Global Settings for CFM](#)").

CONFIGURING GLOBAL SETTINGS FOR CFM

Use the Administration > CFM (Configure Global) page to configure global settings for CFM, such as enabling the CFM process on the switch, setting the start-up delay for cross-check operations, configuring parameters for the link trace cache, and enabling traps for events discovered by continuity check messages or cross-check messages.

CLI REFERENCES

- ◆ ["CFM Commands" on page 1347](#)

PARAMETERS

These parameters are displayed:

Global Configuration

- ◆ **CFM Status** – Enables CFM processing globally on the switch. (Default: Enabled)

To avoid generating an excessive number of traps, the complete CFM maintenance structure and process parameters should be configured prior to enabling CFM processing globally on the switch. Specifically, the maintenance domains, maintenance associations, and maintenance end-points (MEPs) should be configured on each participating bridge using the Configure MD page (see ["Configuring CFM Maintenance Domains"](#)), Configure MA page (see ["Configuring CFM Maintenance Associations"](#)), and the Configure MEP page (see ["Configuring Maintenance End Points"](#)).

When CFM is enabled, hardware resources are allocated for CFM processing.

- ◆ **MEP Cross Check Start Delay** – Sets the maximum delay that a device waits for remote MEPs to come up before starting the cross-check operation. (Range: 1-65535 seconds; Default: 10 seconds)

This parameter sets the time to wait for a remote MEP to come up, and the switch starts cross-checking the list of statically configured remote MEPs in the local maintenance domain (Configure Remote MEP page, see ["Configuring Remote Maintenance End Points"](#)) against the MEPs learned through continuity check messages (CCMs).

The cross-check start delay should be configured to a value greater than or equal to the continuity check message interval to avoid generating unnecessary traps (see ["Configuring CFM Maintenance Associations"](#)).

Link Trace Cache Settings

- ◆ **Link Trace Cache** – Enables caching of CFM data learned through link trace messages. (Default: Enabled)

A linktrace message is a multicast CFM frame initiated by a MEP, and forwarded from MIP to MIP, with each MIP generating a linktrace reply, up to the point at which the linktrace message reaches its destination or can no longer be forwarded.

Use this command attribute to enable the link trace cache to store the results of link trace operations initiated on this device. Use the CFM Transmit Link Trace page (see ["Transmitting Link Trace Messages"](#)) to transmit a linktrace message.

Linktrace responses are returned from each MIP along the path and from the target MEP. Information stored in the cache includes the maintenance domain name, MA name, MEPID, sequence number, and TTL value (see ["Displaying Fault Notification Settings"](#)).

- ◆ **Link Trace Cache Hold Time** – The hold time for CFM link trace cache entries. (Range: 1-65535 minutes; Default: 100 minutes)

Before setting the aging time for cache entries, the cache must first be enabled in the Linktrace Cache attribute field.

- ◆ **Link Trace Cache Size** – The maximum size for the link trace cache. (Range: 1-4095 entries; Default: 100 entries)

If the cache reaches the maximum number of specified entries, or the size is set to a value less than the current number of stored entries, no new entries are added. To add additional entries, the cache size must first be increased, or purged (see "[Displaying Fault Notification Settings](#)").

Continuity Check Errors

- ◆ **Connectivity Check Config** – Sends a trap if this device receives a continuity check message (CCM) with the same maintenance end point identifier (MPID) as its own but with a different source MAC address, indicating that a CFM configuration error exists.
- ◆ **Connectivity Check Loop** – Sends a trap if this device receives a CCM with the same source MAC address and MPID as its own, indicating that a forwarding loop exists.
- ◆ **Connectivity Check MEP Down** – Sends a trap if this device loses connectivity with a remote maintenance end point (MEP), or connectivity has been restored to a remote MEP which has recovered from an error condition.
- ◆ **Connectivity Check MEP Up** – Sends a trap if a remote MEP is discovered and added to the local database, the port state of a previously discovered remote MEP changes, or a CCM is received from a remote MEP which as an expired entry in the archived database.

MEP Up traps are suppressed when cross-checking of MEPs is enabled¹³ because cross-check traps include more detailed status information.

Cross-check Errors

- ◆ **Cross Check MA Up** – Sends a trap when all remote MEPs in an MA come up.

An MA Up trap is sent if cross-checking is enabled¹³, and a CCM is received from all remote MEPs configured in the static list for this maintenance association¹⁴.

- ◆ **Cross Check MEP Missing** – Sends a trap if the cross-check timer expires and no CCMs have been received from a remote MEP configured in the static list.

A MEP Missing trap is sent if cross-checking is enabled¹³, and no CCM is received for a remote MEP configured in the static list¹⁴.

13. Cross-checking must be enabled for this type of trap to be reported (see "[Configuring CFM Maintenance Associations](#)").

14. See "[Configuring Maintenance End Points](#)".

- ◆ **Cross Check MEP Unknown** – Sends a trap if an unconfigured MEP comes up.

A MEP Unknown trap is sent if cross-checking is enabled¹³, and a CCM is received from a remote MEP that is not configured in the static list¹⁴.

WEB INTERFACE

To configure global settings for CFM:

1. Click Administration, CFM.
2. Select Configure Global from the Step list.
3. Before enabling CFM processing on the switch, first configure the required CFM domains, maintenance associations, and static MEPs. Then set the delay time to wait for a remote MEP comes up before the switch starts cross-checking the end points learned through CCMs against those stored in the static list.
4. Adjust the parameters for the link trace cache as required.
5. Enable the required traps for continuity check and cross-check errors. Remember that the "Connectivity Check" and "Cross Check" fields on the MA Configuration page must be enabled before related errors can be generated.
6. Click Apply.

Figure 296: Configuring Global Settings for CFM

Administration > CFM

Step: 1. Configure Global

Global Configuration

CFM Status Enabled

MEP Cross Check Start Delay (1-65535) sec

Link Trace Cache Enabled

Link Trace Cache Hold Time (1-65535) min

Link Trace Cache Size (1-4095) entries

SNMP Trap Configuration

Connectivity Check Config Enabled

Connectivity Check Loop Enabled

Connectivity Check MEP Down Enabled

Connectivity Check MEP Up Enabled

Cross Check MA Up Enabled

Cross Check MEP Missing Enabled

Cross Check MEP Unknown Enabled

Apply Revert

CONFIGURING INTERFACES FOR CFM

CFM processes are enabled by default for all physical interfaces, both ports and trunks. You can use the Administration > CFM (Configure Interface) page to change these settings.

CLI REFERENCES

- ◆ ["ethernet cfm port-enable" on page 1359](#)

COMMAND USAGE

- ◆ An interface must be enabled before a MEP can be created (see ["Configuring Maintenance End Points"](#)).
- ◆ If a MEP has been configured on an interface, it must first be deleted before CFM can be disabled on that interface.
- ◆ When CFM is disabled, hardware resources previously used for CFM processing on that interface are released, and all CFM frames entering that interface are forwarded as normal data traffic.

WEB INTERFACE

To enable CFM on an interface:

1. Click Administration, CFM.
2. Select Configure Interface from the Step list.
3. Select Port or Trunk.
4. Enable CFM on the required interface.
5. Click Apply.

Figure 297: Configuring Interfaces for CFM

The screenshot shows the 'Administration > CFM' web interface. At the top, there is a breadcrumb 'Administration > CFM' and a 'Step:' dropdown menu set to '2. Configure Interface'. Below this, there are radio buttons for 'Interface' with 'Port' selected and 'Trunk' unselected. A 'Port List' section shows 'Total: 52' and a table with 5 rows. The table has two columns: 'Port' and 'CFM Status'. All ports listed (1 through 5) have a checked checkbox and the text 'Enabled'.

Port	CFM Status
1	<input checked="" type="checkbox"/> Enabled
2	<input checked="" type="checkbox"/> Enabled
3	<input checked="" type="checkbox"/> Enabled
4	<input checked="" type="checkbox"/> Enabled
5	<input checked="" type="checkbox"/> Enabled

CONFIGURING CFM MAINTENANCE DOMAINS

Use the Administration > CFM (Configure MD) pages to create and configure a Maintenance Domain (MD) which defines a portion of the network for which connectivity faults can be managed. Domain access points are set up on the boundary of a domain to provide end-to-end connectivity fault detection, analysis, and recovery. Domains can be configured in a hierarchy to provide management access to the same basic network resources for different user levels.

CLI REFERENCES

- ◆ ["CFM Commands" on page 1347](#)

COMMAND USAGE

Configuring General Settings

- ◆ Where domains are nested, an upper-level hierarchical domain must have a higher maintenance level than the ones it encompasses. The higher to lower level domain types commonly include entities such as customer, service provider, and operator.
- ◆ More than one domain can be configured at the same maintenance level, but a single domain can only be configured with one maintenance level.
- ◆ If MEPs (see ["Configuring Maintenance End Points"](#)) or MAs (see ["Configuring CFM Maintenance Associations"](#)) are configured for a domain, they must first be removed before you can remove the domain.

Maintenance domains are designed to provide a transparent method of verifying and resolving connectivity problems for end-to-end connections. By default, these connections run between the domain service access points (DSAPs) within each MA defined for a domain, and are manually configured (see ["Configuring Maintenance End Points"](#)).

In contrast, MIPs are interconnection points that make up all possible paths between the DSAPs within an MA. MIPs are automatically generated by the CFM protocol when the MIP Creation Type is set to "Default" or "Explicit," and the MIP creation state machine is invoked (as defined in IEEE 802.1ag). The default option allows MIPs to be created for all interconnection points within an MA, regardless of the domain's level in the maintenance hierarchy (e.g., customer, provider, or operator). While the explicit option only generates MIPs within an MA if its associated domain is not at the bottom of the maintenance hierarchy. This option is used to hide the structure of network at the lowest domain level.

The diagnostic functions provided by CFM can be used to detect connectivity failures between any pair of MEPs in an MA. Using MIPs allows these failures to be isolated to smaller segments of the network.

Allowing the CFM to generate MIPs exposes more of the network structure to users at higher domain levels, but can speed up the process of fault detection and recovery. This trade-off should be carefully considered when designing a CFM maintenance structure.

Also note that while MEPs are active agents which can initiate consistency check messages (CCMs), transmit loop back or link trace messages, and maintain the local CCM database, MIPs, on the other hand, are passive agents which can only validate received CFM messages, and respond to loop back and link trace messages.

The MIP creation method defined for an MA (see "[Configuring CFM Maintenance Associations](#)") takes precedence over the method defined on the CFM Domain List.

Configuring Fault Notification

- ◆ A fault alarm can generate an SNMP notification. It is issued when the MEP fault notification generator state machine detects that the configured time period (MEP Fault Notify Alarm Time) has passed with one or more defects indicated, and fault alarms are enabled at or above the specified priority level (MEP Fault Notify Lowest Priority). The state machine transmits no further fault alarms until it is reset by the passage of a configured time period (MEP Fault Notify Reset Time) without a defect indication. The normal procedure upon receiving a fault alarm is to inspect the reporting MEP's managed objects using an appropriate SNMP software tool, diagnose the fault, correct it, re-examine the MEP's managed objects to see whether the MEP fault notification generator state machine has been reset, and repeat those steps until the fault is resolved.
- ◆ Only the highest priority defect currently detected is reported in the fault alarm.

Priority levels include the following options:

Table 36: Remote MEP Priority Levels

Priority Level	Level Name	Description
1	allDef	All defects.
2	macRemErrXcon	DefMACstatus, DefRemoteCCM, DefErrorCCM, or DefXconCCM.
3	remErrXcon	DefErrorCCM, DefXconCCM or DefRemoteCCM.
4	errXcon	DefErrorCCM or DefXconCCM.
5	xcon	DefXconCCM
6	noXcon	No defects DefXconCCM or lower are to be reported.

Table 37: MEP Defect Descriptions

Defect	Description
DefMACstatus	Either some remote MEP is reporting its Interface Status TLV as not isUp, or all remote MEPs are reporting a Port Status TLV that contains some value other than psUp.
DefRemoteCCM	The MEP is not receiving valid CCMs from at least one of the remote MEPs.
DefErrorCCM	The MEP has received at least one invalid CCM whose CCM Interval has not yet timed out.
DefXconCCM	The MEP has received at least one CCM from either another MAID or a lower MD Level whose CCM Interval has not yet timed out.

PARAMETERS

These parameters are displayed:

Creating a Maintenance Domain

- ◆ **MD Index** – Domain index. (Range: 1-65535)
- ◆ **MD Name** – Maintenance domain name. (Range: 1-43 alphanumeric characters)
- ◆ **MD Level** – Authorized maintenance level for this domain. (Range: 0-7)
- ◆ **MIP Creation Type** – Specifies the CFM protocol's creation method for maintenance intermediate points (MIPs) in this domain:
 - **Default** – MIPs can be created for any maintenance association (MA) configured in this domain on any bridge port through which the MA's VID can pass.
 - **Explicit** – MIPs can be created for any MA configured in this domain only on bridge ports through which the MA's VID can pass, and only if a maintenance end point (MEP) is created at some lower MA Level.
 - **None** – No MIP can be created for any MA configured in this domain.

Configuring Detailed Settings for a Maintenance Domain

- ◆ **MD Index** – Domain index. (Range: 1-65535)
- ◆ **MEP Archive Hold Time** – The time that data from a missing MEP is retained in the continuity check message (CCM) database before being purged. (Range: 1-65535 minutes; Default: 100 minutes)

A change to the hold time only applies to entries stored in the database after this attribute is changed.
- ◆ **MEP Fault Notify Lowest Priority** – The lowest priority defect that is allowed to generate a fault alarm. (Range: 1-6, Default: 2)
- ◆ **MEP Fault Notify Alarm Time** – The time that one or more defects must be present before a fault alarm is issued. (Range: 3-10 seconds; Default: 3 seconds)
- ◆ **MEP Fault Notify Reset Time** – The time after a fault alarm has been issued, and no defect exists, before another fault alarm can be issued. (Range: 3-10 seconds; Default: 10 seconds)

WEB INTERFACE

To create a maintenance domain:

1. Click Administration, CFM.
2. Select Configure MD from the Step list.
3. Select Add from the Action list.
4. Specify the maintenance domains and authorized maintenance levels (thereby setting the hierarchical relationship with other domains).
5. Specify the manner in which MIPs can be created within each domain.
6. Click Apply.

Figure 298: Configuring Maintenance Domains

To show the configured maintenance domains:

1. Click Administration, CFM.
2. Select Configure MD from the Step list.
3. Select Show from the Action list.

Figure 299: Showing Maintenance Domains

	MD Index	MD Name	MD Level	MIP Creation Type
<input type="checkbox"/>	1	voip	3	Explicit

To configure detailed settings for maintenance domains:

1. Click Administration, CFM.
2. Select Configure MD from the Step list.
3. Select Configure Details from the Action list.
4. Select an entry from the MD Index.
5. Specify the MEP archive hold and MEP fault notification parameters.
6. Click Apply

Figure 300: Configuring Detailed Settings for Maintenance Domains

The screenshot shows a web interface for configuring maintenance domains. At the top, it says 'Administration > CFM'. Below that, there are two dropdown menus: 'Step: 3. Configure MD' and 'Action: Configure Details'. The main area contains five rows of configuration fields:

MD Index	1
MEP Archive Hold Time (1-65535)	100
MEP Fault Notify Lowest Priority (1-6)	2
MEP Fault Notify Alarm Time (3-10)	3
MEP Fault Notify Reset Time (3-10)	10

At the bottom right, there are two buttons: 'Apply' and 'Revert'.

CONFIGURING CFM MAINTENANCE ASSOCIATIONS

Use the Administration > CFM (Configure MA) pages to create and configure the Maintenance Associations (MA) which define a unique CFM service instance. Each MA can be identified by its parent MD, the MD's maintenance level, the VLAN assigned to the MA, and the set of maintenance end points (MEPs) assigned to it.

CLI REFERENCES

- ◆ ["CFM Commands" on page 1347](#)

COMMAND USAGE

Creating a Maintenance Association

- ◆ Use the Configure MA – Add screen to create an MA within the selected MD, map it to a customer service instance (S-VLAN), and set the manner in which MIPs are created for this service instance. Then use the MEP List to assign domain service access points (DSAPs) to this service instance (see ["Configuring Maintenance End Points" on page 537](#)).
- ◆ An MA must be defined before any associated DSAPs or remote MEPs can be assigned (see ["Configuring Remote Maintenance End Points" on page 538](#)).

- ◆ Multiple domains at the same maintenance level cannot have an MA on the same VLAN (see ["Configuring CFM Maintenance Domains" on page 527](#)).
- ◆ Before removing an MA, first remove the MEPs assigned to it (see ["Configuring Maintenance End Points" on page 537](#)).
- ◆ For a detailed description of the MIP types, refer to the Command Usage section under ["Configuring CFM Maintenance Domains" on page 527](#).

Configuring Detailed Settings for a Maintenance Association

- ◆ CCMs are multicast periodically by a MEP in order to discover other MEPs in the same MA, and to assure connectivity to all other MEPs/MIPs in the MA.
- ◆ Each CCM received is checked to verify that the MEP identifier field sent in the message does not match its own MEP ID, which would indicate a duplicate MEP or network loop. If these error types are not found, the CCM is stored in the MEP's local database until aged out.
- ◆ If a maintenance point fails to receive three consecutive CCMs from any other MEP in the same MA, a connectivity failure is registered.
- ◆ If a maintenance point receives a CCM with an invalid MEPID or MA level or an MA level lower than its own, a failure is registered which indicates a configuration error or cross-connect error (i.e., overlapping MAs).
- ◆ The interval at which CCMs are issued should be configured to detect connectivity problems in a timely manner, as dictated by the nature and size of the MA.
- ◆ The maintenance of a MIP CCM database by a MIP presents some difficulty for bridges carrying a large number of Service Instances, and for whose MEPs are issuing CCMs at a high frequency. For this reason, slower CCM transmission rates may have to be used.

PARAMETERS

These parameters are displayed:

Creating a Maintenance Association

- ◆ **MD Index** – Domain index. (Range: 1-65535)
- ◆ **MA Index** – MA identifier. (Range: 1-2147483647)
- ◆ **MA Name** – MA name. (Range: 1-43 alphanumeric characters)
Each MA name must be unique within the CFM domain.
- ◆ **Primary VLAN** – Service VLAN ID. (Range: 1-4094)
This is the VLAN through which all CFM functions are executed for this MA.

- ◆ **MIP Creation Type** – Specifies the CFM protocol’s creation method for maintenance intermediate points (MIPs) in this MA:
 - **Default** – MIPs can be created for this MA on any bridge port through which the MA’s VID can pass.
 - **Explicit** – MIPs can be created for this MA only on bridge ports through which the MA’s VID can pass, and only if a maintenance end point (MEP) is created at some lower MA Level.
 - **None** – No MIP can be created for this MA.

Configuring Detailed Settings for a Maintenance Association

- ◆ **MD Index** – Domain index. (Range: 1-65535)
- ◆ **MA Index** – MA identifier. (Range: 1-2147483647)
- ◆ **MA Name Format** – Specifies the name format for the maintenance association as IEEE 802.1ag character based, or ITU-T SG13/SG15 Y.1731 defined ICC-based format.
 - **Character String** – IEEE 802.1ag defined character string format. This is an IETF RFC 2579 DisplayString.
 - **ICC Based** – ITU-T SG13/SG15 Y.1731 defined ICC based format.
- ◆ **Interval Level** – The delay between sending CCMs. The setting for this parameter is expressed as levels 4 through 7, which in turn map to specific intervals of time. (Options: 4 - 1 second, 5 - 10 seconds, 6 - 1 minute, 7 - 10 minutes)
- ◆ **Connectivity Check** – Enables transmission of CCMs. (Default: Disabled)
- ◆ **Cross Check** – Enables cross-checking between a static list of MEPs assigned to other devices within the same maintenance association and the MEPs learned through CCMs.

Before starting the cross-check process, first configure the remote MEPs that exist on other devices inside the maintenance association using the Remote MEP List (see "[Configuring Remote Maintenance End Points](#)"). These remote MEPs are used in the cross-check operation to verify that all endpoints in the specified MA are operational.

The cross-check start delay, which sets the maximum delay this device waits for a remote MEP to come up before starting the cross-check operation, is a domain-level parameter. To set this parameter, use the CFM MD Configuration screen (see "[Configuring CFM Maintenance Domains](#)").

- ◆ **AIS Status** – Enables/disables suppression of the Alarm Indication Signal (AIS). (Default: Enabled)
- ◆ **AIS Period** – Configures the period at which AIS is sent in an MA. (Range: 1 or 60 seconds; Default: 1 second)

- ◆ **AIS Transmit Level** – Configure the AIS maintenance level in an MA.
(Range: 0-7; Default is 0)
AIS Level must follow this rule: AIS Level >= Domain Level
- ◆ **AIS Suppress Alarm** – Enables/disables suppression of the AIS.
(Default: Disabled)

WEB INTERFACE

To create a maintenance association:

1. Click Administration, CFM.
2. Select Configure MA from the Step list.
3. Select Add from the Action list.
4. Select an entry from the MD Index list.
5. Specify the MAs assigned to each domain, the VLAN through which CFM messages are passed, and the manner in which MIPs can be created within each MA.
6. Click Apply.

Figure 301: Creating Maintenance Associations

The screenshot shows a web interface for configuring maintenance associations. The breadcrumb is 'Administration > CFM'. At the top, there are two dropdown menus: 'Step' is set to '4. Configure MA' and 'Action' is set to 'Add'. Below these are several input fields: 'MD Index' is a dropdown menu with '1' selected; 'MA Index (1-2147483647)' is a text input field containing '1'; 'MA Name' is a text input field containing 'rd'; 'Primary VLAN (1-4094)' is an empty text input field; and 'MIP Creation Type' is a dropdown menu with 'Default' selected. At the bottom right of the form area are two buttons: 'Apply' and 'Revert'.

To show the configured maintenance associations:

1. Click Administration, CFM.
2. Select Configure MA from the Step list.
3. Select Show from the Action list.
4. Select an entry from the MD Index list.

Figure 302: Showing Maintenance Associations

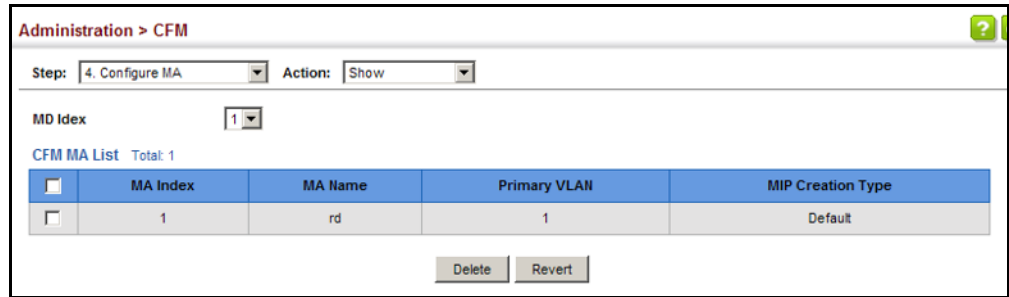

To configure detailed settings for maintenance associations:

1. Click Administration, CFM.
2. Select Configure MA from the Step list.
3. Select Configure Details from the Action list.
4. Select an entry from MD Index and MA Index.
5. Specify the CCM interval, enable the transmission of connectivity check and cross check messages, and configure the required AIS parameters.
6. Click Apply

Figure 303: Configuring Detailed Settings for Maintenance Associations

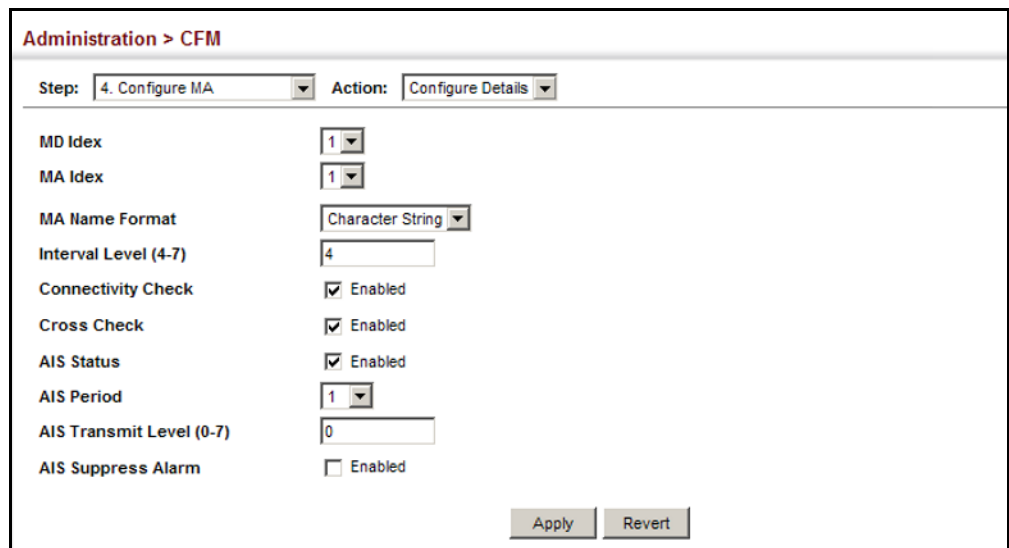

**CONFIGURING
MAINTENANCE
END POINTS**

Use the Administration > CFM (Configure MEP – Add) page to configure Maintenance End Points (MEPs). MEPs, also called Domain Service Access Points (DSAPs), must be configured at the domain boundary to provide management access for each maintenance association.

CLI REFERENCES

- ◆ ["CFM Commands" on page 1347](#)

COMMAND USAGE

- ◆ CFM elements must be configured in the following order: (1) maintenance domain at the same level as the MEP to be configured (see ["Configuring CFM Maintenance Domains"](#)), (2) maintenance association within the domain (see ["Configuring CFM Maintenance Associations"](#)), and (3) finally the MEPs using the MEP List.
- ◆ An interface may belong to more than one domain, or to different MAs in different domains.
- ◆ To change the MEP's MA or the direction it faces, first delete the MEP, and then create a new one.

PARAMETERS

These parameters are displayed:

- ◆ **MD Index** – Domain index. (Range: 1-65535)
- ◆ **MA Index** – MA identifier. (Range: 1-2147483647)
- ◆ **MEP ID** – Maintenance end point identifier. (Range: 1-8191)
- ◆ **MEP Direction** – Up indicates that the MEP faces inward toward the switch cross-connect matrix, and transmits CFM messages towards, and receives them from, the direction of the internal bridge relay mechanism. If the **Up** option is not selected, then the MEP is facing away from the switch, and transmits CFM messages towards, and receives them from, the direction of the physical medium.
- ◆ **Interface** – Indicates a port or trunk.

WEB INTERFACE

To configure a maintenance end point:

1. Click Administration, CFM.
2. Select Configure MEP from the Step list.
3. Select Add from the Action list.
4. Select an entry from MD Index and MA Index.
5. Specify the MEPs assigned to each MA, set the MEP identifier, the direction in which the MEP faces, and the physical interface serving as the DSAP.

6. Click Apply.

Figure 304: Configuring Maintenance End Points

The screenshot shows the 'Administration > CFM' configuration page. At the top, the breadcrumb is 'Administration > CFM'. Below it, the 'Step' is set to '3. Configure MEP' and the 'Action' is 'Add'. The configuration fields are: MD Index (dropdown with '1'), MA Index (dropdown with '1'), MEP ID (1-8191) (text input with '1'), MEP Direction (checkbox for 'Up' is unchecked), and Interface (radio buttons for 'Port' and 'Trunk', with 'Port' selected and a dropdown showing '1'). At the bottom right, there are 'Apply' and 'Revert' buttons.

To show the configured maintenance end points:

1. Click Administration, CFM.
2. Select Configure MEP from the Step list.
3. Select Show from the Action list.
4. Select an entry from MD Index and MA Index.

Figure 305: Showing Maintenance End Points

The screenshot shows the 'Administration > CFM' configuration page with the 'Action' set to 'Show'. Below the configuration fields, there is a table titled 'CFM Maintenance Association End Point List' with a 'Total: 1' indicator. The table has columns for 'MEP ID', 'MEP Direction', and 'Interface'. There is one row with MEP ID '1', MEP Direction 'Down', and Interface 'Unit 1 / Port 1'. At the bottom right, there are 'Delete' and 'Revert' buttons.

	MEP ID	MEP Direction	Interface
<input type="checkbox"/>	1	Down	Unit 1 / Port 1

CONFIGURING REMOTE MAINTENANCE END POINTS

Use the Administration > CFM (Configure Remote MEP – Add) page to specify remote maintenance end points (MEPs) set on other CFM-enabled devices within a common MA. Remote MEPs can be added to a static list in this manner to verify that each entry has been properly configured and is operational. When cross-checking is enabled, the list of statically configured remote MEPs is compared against the MEPs learned through continuity check messages (CCMs), and any discrepancies reported via SNMP traps.

CLI REFERENCES

- ◆ ["CFM Commands" on page 1347](#)

COMMAND USAGE

- ◆ All MEPs that exist on other devices inside a maintenance association should be statically configured to ensure full connectivity through the cross-check process.
- ◆ Remote MEPs can only be configured if local domain service access points (DSAPs) have already been created (see "[Configuring Maintenance End Points](#)") at the same maintenance level and in the same MA. DSAPs are MEPs that exist on the edge of the domain, and act as primary service access points for end-to-end cross-check, loop-back, and link-trace functions.
- ◆ The MEP cross-check start delay which sets the maximum delay that a device waits for remote MEPs to come up before starting the cross-check operation can be configured on the Configure Global page (see "[Configuring Global Settings for CFM](#)").
- ◆ SNMP traps for continuity check events discovered by cross-check operations can also be configured on the Configure Global page (see "[Configuring Global Settings for CFM](#)").

PARAMETERS

These parameters are displayed:

- ◆ **MD Index** – Domain index. (Range: 1-65535)
- ◆ **MA Index** – MA identifier. (Range: 1-2147483647)
- ◆ **MEP ID** – Identifier for a maintenance end point which exists on another CFM-enabled device within the same MA. (Range: 1-8191)

WEB INTERFACE

To configure a remote maintenance end point:

1. Click Administration, CFM.
2. Select Configure Remote MEP from the Step list.
3. Select Add from the Action list.
4. Select an entry from MD Index and MA Index.
5. Specify the remote MEPs which exist on other devices within the same MA.
6. Click Apply.

Figure 306: Configuring Remote Maintenance End Points



To show the configured remote maintenance end points:

1. Click Administration, CFM.
2. Select Configure MEP from the Step list.
3. Select Show from the Action list.
4. Select an entry from MD Index and MA Index.

Figure 307: Showing Remote Maintenance End Points

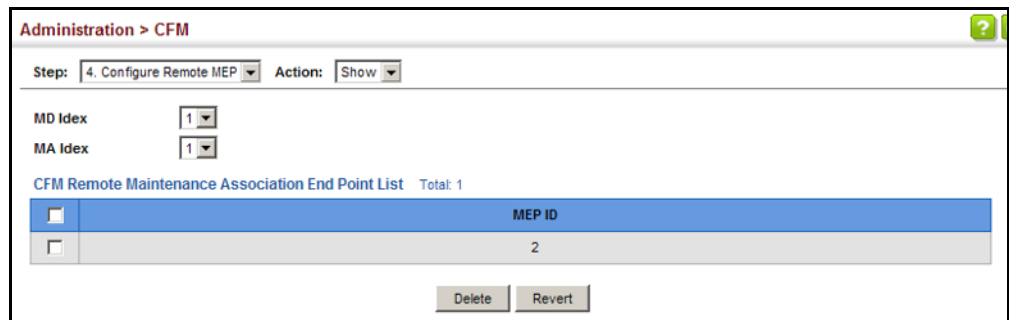

TRANSMITTING LINK TRACE MESSAGES

Use the Administration > CFM (Transmit Link Trace) page to transmit link trace messages (LTMs). These messages can isolate connectivity faults by tracing the path through a network to the designated target node (i.e., a remote maintenance end point).

CLI REFERENCES

- ◆ ["CFM Commands" on page 1347](#)

COMMAND USAGE

- ◆ LTMs can be targeted to MEPs, not MIPs. Before sending a link trace message, be sure you have configured the target MEP for the specified MA (see ["Configuring Remote Maintenance End Points"](#)).
- ◆ If MAC address of target MEP has not been learned by any local MEP, then the linktrace may fail. Use the Show Remote MEP page (see ["Displaying Remote MEPs"](#)) to verify that a MAC address has been learned for the target MEP.

- ◆ LTM's are sent as multicast CFM frames, and forwarded from MIP to MIP, with each MIP generating a link trace reply, up to the point at which the LTM reaches its destination or can no longer be forwarded.
- ◆ LTM's are used to isolate faults. However, this task can be difficult in an Ethernet environment, since each node is connected through multipoint links. Fault isolation is even more challenging since the MAC address of the target node can age out in several minutes. This can cause the traced path to vary over time, or connectivity lost if faults cause the target MEP to be isolated from other MEPs in an MA.
- ◆ When using the command line or web interface, the source MEP used by to send a link trace message is chosen by the CFM protocol. However, when using SNMP, the source MEP can be specified by the user.
- ◆ Parameters controlling the link trace cache, including operational state, entry hold time, and maximum size can be configured on the Configure Global page (see "[Configuring Global Settings for CFM](#)").

PARAMETERS

These parameters are displayed:

- ◆ **MD Index** – Domain index. (Range: 1-65535)
- ◆ **MA Index** – MA identifier. (Range: 1-2147483647)
- ◆ **Source MEP ID** – The identifier of a source MEP that will send the link trace message. (Range: 1-8191)
- ◆ **Target**
 - **MEP ID** – The identifier of a remote MEP that is the target of a link trace message. (Range: 1-8191)
 - **MAC Address** – MAC address of a remote MEP that is the target of a link trace message. This address can be entered in either of the following formats: xx-xx-xx-xx-xx-xx or xxxxxxxxxxxx
- ◆ **TTL** – The time to live of the link trace message. (Range: 0-255 hops)

WEB INTERFACE

To transmit link trace messages:

1. Click Administration, CFM.
2. Select Transmit Link Trace from the Step list.
3. Select an entry from MD Index and MA Index.
4. Specify the source MEP, the target MEP using either its MEP identifier or MAC address, and set the maximum number of hops allowed in the TTL field.

5. Click Apply.
6. Check the results in the Link Trace cache (see ["Displaying the Link Trace Cache"](#)).

Figure 308: Transmitting Link Trace Messages

The screenshot shows a web interface for 'Administration > CFM'. The current step is '7. Transmit Link Trace'. The form contains the following fields and values:

- MD Index: 1
- MA Index: 1
- Source MEP ID (1-8191): 1
- Target: MEP ID (1-8191) 2
- MAC Address:
- TTL (0-255): 5

Buttons for 'Apply' and 'Revert' are located at the bottom right of the form.

TRANSMITTING LOOP BACK MESSAGES

Use the Administration > CFM (Transmit Loopback) page to transmit Loopback Messages (LBMs). These messages can be used to isolate or verify connectivity faults by submitting a request to a target node (i.e., a remote MEP or MIP) to echo the message back to the source.

CLI REFERENCES

- ◆ ["CFM Commands" on page 1347](#)

COMMAND USAGE

- ◆ Loopback messages can be used for fault verification and isolation after automatic detection of a fault or receipt of some other error report. Loopback messages can also be used to confirm the successful restoration or initiation of connectivity. The receiving maintenance point should respond to the loop back message with a loopback reply.
- ◆ The point from which the loopback message is transmitted (i.e., a local DSAP) and the target maintenance point must be within the same MA.
- ◆ If the continuity check database does not have an entry for the specified maintenance point, an error message will be displayed.
- ◆ When using the command line or web interface, the source MEP used by to send a loopback message is chosen by the CFM protocol. However, when using SNMP, the source MEP can be specified by the user.

PARAMETERS

These parameters are displayed:

- ◆ **MD Index** – Domain index. (Range: 1-65535)

- ◆ **MA Index** – MA identifier. (Range: 1-2147483647)
- ◆ **Source MEP ID** – The identifier of a source MEP that will send the loopback message. (Range: 1-8191)
- ◆ **Target**
 - **MEP ID** – The identifier of a remote MEP that is the target of a loopback message. (Range: 1-8191)
 - **MAC Address** – MAC address of a remote MEP that is the target of a loopback message. This address can be entered in either of the following formats: xx-xx-xx-xx-xx-xx or xxxxxxxxxxxx
- ◆ **Count** – The number of times the loopback message is sent. (Range: 1-1024)
- ◆ **Packet Size** – The size of the loopback message. (Range: 64-1518 bytes; Default: 64 bytes)

WEB INTERFACE

To transmit loopback messages:

1. Click Administration, CFM.
2. Select Transmit Loopback from the Step list.
3. Select an entry from MD Index and MA Index.
4. Specify the source MEP, the target MEP using either its MEP identifier or MAC address, set the number of times the loopback message is to be sent.
5. Click Apply.

Figure 309: Transmitting Loopback Messages

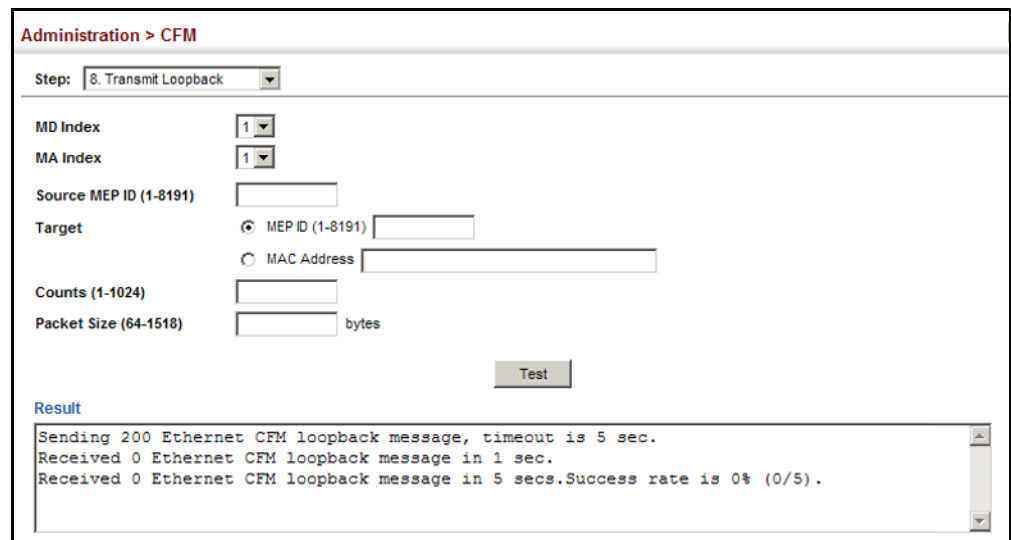

TRANSMITTING DELAY-MEASURE REQUESTS Use the Administration > CFM (Transmit Delay Measure) page to send periodic delay-measure requests to a specified MEP within a maintenance association.

CLI REFERENCES

- ◆ ["ethernet cfm delay-measure two-way" on page 1386](#)

COMMAND USAGE

- ◆ Delay measurement can be used to measure frame delay and frame delay variation between MEPs.
- ◆ A local MEP must be configured for the same MA before you can use this function.
- ◆ If a MEP is enabled to generate frames with delay measurement (DM) information, it periodically sends DM frames to its peer MEP in the same MA., and expects to receive DM frames back from it.
- ◆ Frame delay measurement can be made only for two-way measurements, where the MEP transmits a frame with DM request information with the TxTimeStampf (Timestamp at the time of sending a frame with DM request information), and the receiving MEP responds with a frame with DM reply information with TxTimeStampf copied from the DM request information, RxTimeStampf (Timestamp at the time of receiving a frame with DM request information), and TxTimeStampb (Timestamp at the time of transmitting a frame with DM reply information):
$$\text{Frame Delay} = (\text{RxTimeStampb} - \text{TxTimeStampf}) - (\text{TxTimeStampb} - \text{RxTimeStampf})$$
- ◆ The MEP can also make two-way frame delay variation measurements based on its ability to calculate the difference between two subsequent two-way frame delay measurements.

PARAMETERS

These parameters are displayed:

- ◆ **MD Index** – Domain index. (Range: 1-65535)
- ◆ **MA Index** – MA identifier. (Range: 1-2147483647)
- ◆ **Source MEP ID** – The identifier of a source MEP that will send the delay-measure message. (Range: 1-8191)
- ◆ **Target**
 - **MEP ID** – The identifier of a remote MEP that is the target of a delay-measure message. (Range: 1-8191)
 - **MAC Address** – MAC address of a remote MEP that is the target of a delay-measure message. This address can be entered in either of the following formats: xx-xx-xx-xx-xx-xx or xxxxxxxxxxxx

- ◆ **Count** – The number of times to retry sending the message if no response is received before the specified timeout. (Range: 1-5; Default: 5)
- ◆ **Packet Size** – The size of the delay-measure message. (Range: 64-1518 bytes; Default: 64 bytes)
- ◆ **Interval** – The transmission delay between delay-measure messages. (Range: 1-5 seconds; Default: 1 second)
- ◆ **Timeout** – The timeout to wait for a response. (Range: 1-5 seconds; Default: 5 seconds)

WEB INTERFACE

To transmit delay-measure messages:

1. Click Administration, CFM.
2. Select Transmit Delay Measure from the Step list.
3. Select an entry from MD Index and MA Index.
4. Specify the source MEP, the target MEP using either its MEP identifier or MAC address, set the number of times the delay-measure message is to be sent, the interval, and the timeout.
5. Click Apply.

Figure 310: Transmitting Delay-Measure Messages

Administration > CFM

Step: 7. Transmit Delay Measure

MD Index: 1
 MA Index: 3
 Source MEP ID (1-8191):
 Target: MEP ID (1-8191)
 MAC Address
 Counts (1-5):
 Packet Size (64-1518): bytes
 Interval (1-5): ms
 Timeout (1-5): ms

Apply Revert

Result

```

Sending 5 Ethernet CFM delay measurement message, timeout is 5 sec.
Sequence  Delay Time (ms.)  Delay Variation (ms.)
-----  -
1          < 10                 0
2          10                 10
3          < 10                 10
4          < 10                 0
5          < 10                 0
Success rate is 100% (5/5), delay time min/avg/max=0/2/10 ms.
Average frame delay variation is 4 ms.
    
```

DISPLAYING LOCAL MEPS Use the Administration > CFM > Show Information (Show Local MEP) page to show information for the MEPs configured on this device.

CLI REFERENCES

- ◆ "show ethernet cfm maintenance-points local" on page 1363

PARAMETERS

These parameters are displayed:

- ◆ **MEP ID** – Maintenance end point identifier.
- ◆ **MD Name** – Maintenance domain name.
- ◆ **Level** – Authorized maintenance level for this domain.
- ◆ **Direction** – Direction in which the MEP communicates CFM messages:
 - Down indicates that the MEP is facing away from the switch, and transmits CFM messages towards, and receives them from, the direction of the physical medium.
 - Up indicates that the MEP faces inward toward the switch cross-connect matrix, and transmits CFM messages towards, and receives them from, the direction of the internal bridge relay mechanism.
- ◆ **Primary VLAN** – Service VLAN ID.
- ◆ **Interface** – Physical interface of this entry (either a port or trunk).
- ◆ **CC Status** – Shows administrative status of CCMs.
- ◆ **MAC Address** – MAC address of this MEP entry.

WEB INTERFACE

To show information for the MEPs configured on this device:

1. Click Administration, CFM.
2. Select Show Information from the Step list.
3. Select Show Local MEP from the Action list.

Figure 311: Showing Information on Local MEPs

MEP ID	MD Name	Level	Direction	Primary VLAN	Interface	CC Status	MAC Address
1	voip	3	Down	1	Eth 1/1	Enabled	00-E0-0C-00-00-FE

DISPLAYING DETAILS FOR LOCAL MEPS Use the Administration > CFM > Show Information (Show Local MEP Details) page to show detailed CFM information about a local MEP in the continuity check database.

CLI REFERENCES

- ◆ ["show ethernet cfm maintenance-points local detail mep" on page 1364](#)

PARAMETERS

These parameters are displayed:

- ◆ **MD Index** – Domain index. (Range: 1-65535)
- ◆ **MA Index** – MA identifier. (Range: 1-2147483647)
- ◆ **MEP ID** – Maintenance end point identifier. (Range: 1-8191)
- ◆ **MD Name** – The maintenance domain for this entry.
- ◆ **MA Name** – Maintenance association to which this remote MEP belongs.
- ◆ **MA Name Format** – The format of the Maintenance Association name, including Character String or ICC Based.
- ◆ **Level** – Maintenance level of the local maintenance point.
- ◆ **Direction** – The direction in which the MEP faces on the Bridge port (up or down).
- ◆ **Interface** – The port to which this MEP is attached.
- ◆ **CC Status** – Shows if the MEP will generate CCM messages.
- ◆ **MAC Address** – MAC address of the local maintenance point. (If a CCM for the specified remote MEP has never been received or the local MEP record times out, the address will be set to the initial value of all Fs.)
- ◆ **Defect Condition** – Shows the defect detected on the MEP.
- ◆ **Received RDI** – Receive status of remote defect indication (RDI) messages on the MEP.
- ◆ **AIS Status** – Shows if MEPs within the specified MA are enabled to send frames with AIS information following detection of defect conditions.
- ◆ **AIS Period** – The interval at which AIS information is sent.
- ◆ **AIS Transmit Level** – The maintenance level at which AIS information will be sent for the specified MEP.
- ◆ **Suppress Alarm** – Shows if the specified MEP is configured to suppress sending frames containing AIS information following the detection of defect conditions.

- ◆ **Suppressing Alarms** – Shows if the specified MEP is currently suppressing sending frames containing AIS information following the detection of defect conditions.

WEB INTERFACE

To show detailed information for the MEPs configured on this device:

1. Click Administration, CFM.
2. Select Show Information from the Step list.
3. Select Show Local MEP Details from the Action list.
4. Select an entry from MD Index and MA Index.
5. Select a MEP ID.

Figure 312: Showing Detailed Information on Local MEPs

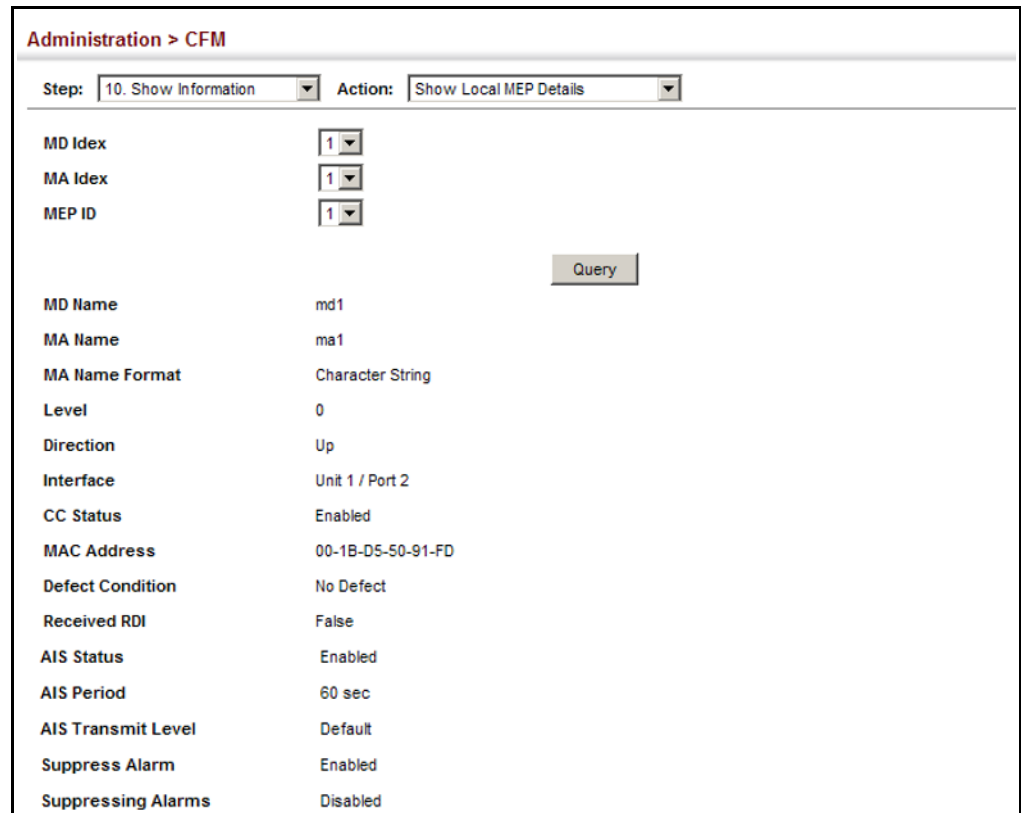

DISPLAYING LOCAL MIPS Use the Administration > CFM > Show Information (Show Local MIP) page to show the MIPS on this device discovered by the CFM protocol. (For a description of MIPS, refer to the Command Usage section under ["Configuring CFM Maintenance Domains"](#).)

CLI REFERENCES

- ◆ ["show ethernet cfm maintenance-points local"](#) on page 1363

PARAMETERS

These parameters are displayed:

- ◆ **MD Name** – Maintenance domain name.
- ◆ **Level** – Authorized maintenance level for this domain.
- ◆ **MA Name** – Maintenance association name.
- ◆ **Primary VLAN** – Service VLAN ID.
- ◆ **Interface** – Physical interface of this entry (either a port or trunk).

WEB INTERFACE

To show information for the MIPs discovered by the CFM protocol:

1. Click Administration, CFM.
2. Select Show Information from the Step list.
3. Select Show Local MIP from the Action list.

Figure 313: Showing Information on Local MIPs

Administration > CFM				
Step: 10. Show Information		Action: Show Local MIP		
CFM Local Maintenance Association Intermediate Point Information Total: 27				
MD Name	Level	MA Name	Primary VLAN	Interface
voip	3	rd	1	Unit 1 / Port 2
voip	3	rd	1	Unit 1 / Port 3
voip	3	rd	1	Unit 1 / Port 4
voip	3	rd	1	Unit 1 / Port 5
voip	3	rd	1	Unit 1 / Port 6
voip	3	rd	1	Unit 1 / Port 7
voip	3	rd	1	Unit 1 / Port 8
voip	3	rd	1	Unit 1 / Port 9
voip	3	rd	1	Unit 1 / Port 10

**DISPLAYING
REMOTE MEPS**

Use the Administration > CFM > Show Information (Show Remote MEP) page to show MEPs located on other devices which have been discovered through continuity check messages, or statically configured in the MEP database and verified through cross-check messages.

CLI REFERENCES

- ◆ ["show ethernet cfm maintenance-points remote detail" on page 1365](#)
- ◆ ["clear ethernet cfm maintenance-points remote" on page 1370](#)

PARAMETERS

These parameters are displayed:

- ◆ **MEP ID** – Maintenance end point identifier.

- ◆ **MA Name** – Maintenance association name.
- ◆ **Level** – Authorized maintenance level for this domain.
- ◆ **Primary VLAN** – Service VLAN ID.
- ◆ **MEP Up** – Indicates whether or not this MEP is functioning normally.
- ◆ **Remote MAC Address** – MAC address of the remote maintenance point. (If a CCM for the specified remote MEP has never been received or the remote MEP record times out, the address will be set to the initial value of all Fs.)

WEB INTERFACE

To show information for remote MEPs:

1. Click Administration, CFM.
2. Select Show Information from the Step list.
3. Select Show Remote MEP from the Action list.

Figure 314: Showing Information on Remote MEPs

Administration > CFM					
Step: 10. Show Information		Action: Show Remote MEP			
CFM Remote Maintenance Association End Point Information Total: 1					
MEP ID	MA Name	Level	Primary VLAN	MEP Up	Remote MAC Address
1	ma1	0	2	Yes	00-01-02-03-04-05

DISPLAYING DETAILS FOR REMOTE MEPS

Use the Administration > CFM > Show Information (Show Remote MEP Details) page to show detailed information for MEPs located on other devices which have been discovered through continuity check messages, or statically configured in the MEP database and verified through cross-check messages.

CLI REFERENCES

- ◆ ["show ethernet cfm maintenance-points remote detail" on page 1365](#)

PARAMETERS

These parameters are displayed:

- ◆ **MD Index** – Domain index. (Range: 1-65535)
- ◆ **MA Index** – MA identifier. (Range: 1-2147483647)
- ◆ **MEP ID** – Maintenance end point identifier. (Range: 1-8191)
- ◆ **MD Name** – Maintenance domain name.

- ◆ **MA Name** – Maintenance association name.
- ◆ **Level** – Authorized maintenance level for this domain.
- ◆ **MAC Address** – MAC address of this MEP entry.
- ◆ **Primary VLAN** – Service VLAN ID.
- ◆ **Incoming Port** – Port to which this remote MEP is attached.
- ◆ **CC Lifetime** – Length of time to hold messages about this MEP in the CCM database.
- ◆ **Age of Last CC Message** – Length of time the last CCM message about this MEP has been in the CCM database.
- ◆ **Frame Loss** – Percentage of transmitted frames lost.
- ◆ **CC Packet Statistics** – The number of CCM packets received successfully and those with errors.
- ◆ **Port State** – Port states include:
 - Up – The port is functioning normally.
 - Blocked – The port has been blocked by the Spanning Tree Protocol.
 - No port state – Either no CCM has been received, or no port status TLV was received in the last CCM.
- ◆ **Interface State** – Interface states include:
 - No Status – Either no CCM has been received, or no interface status TLV was received in the last CCM.
 - Up – The interface is ready to pass packets.
 - Down – The interface cannot pass packets.
 - Testing – The interface is in some test mode.
 - Unknown – The interface status cannot be determined for some reason.
 - Dormant – The interface is not in a state to pass packets but is in a pending state, waiting for some external event.
 - Not Present – Some component of the interface is missing.
 - isLowerLayerDown – The interface is down due to state of the lower layer interfaces.
- ◆ **Crosscheck Status** – Shows if crosscheck function has been enabled.

WEB INTERFACE

To show detailed information for remote MEPs:

1. Click Administration, CFM.
2. Select Show Information from the Step list.
3. Select Show Remote MEP Details from the Action list.
4. Select an entry from MD Index and MA Index.
5. Select a MEP ID.

Figure 315: Showing Detailed Information on Remote MEPs

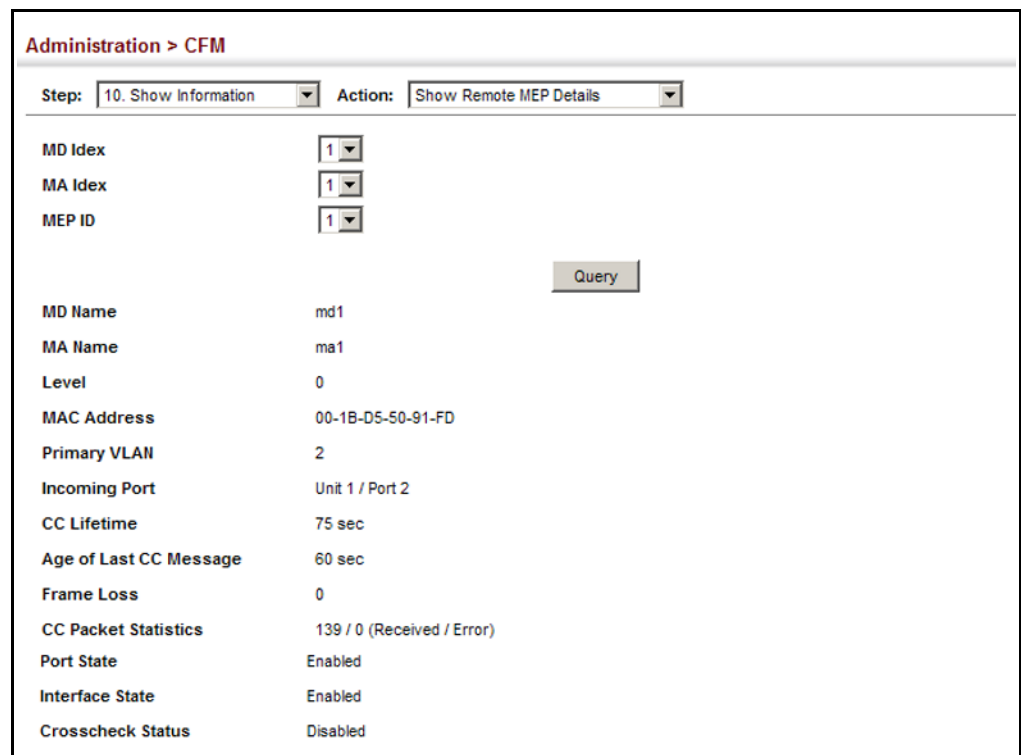

DISPLAYING THE LINK TRACE CACHE

Use the Administration > CFM > Show Information (Show Link Trace Cache) page to show information about link trace operations launched from this device.

CLI REFERENCES

- ◆ ["show ethernet cfm linktrace-cache" on page 1380](#)
- ◆ ["clear ethernet cfm linktrace-cache" on page 1380](#)

PARAMETERS

These parameters are displayed:

- ◆ **Hops** – The number hops taken to reach the target MEP.

- ◆ **MA** – Maintenance association name.
- ◆ **IP Address / Alias** – IP address or DNS alias of the target device’s CPU.
- ◆ **Forwarded** – Shows whether or not this link trace message was forwarded. A message is not forwarded if received by the target MEP.
- ◆ **Ingress MAC Address** – MAC address of the ingress port on the target device.
- ◆ **Egress MAC Address** – MAC address of the egress port on the target device.
- ◆ **Ingress Action** – Action taken on the ingress port:
 - IngOk – The target data frame passed through to the MAC Relay Entity.
 - IngDown – The bridge port’s MAC_Operational parameter is false. This value could be returned, for example, by an operationally Down MEP that has another Down MEP at a higher MD level on the same bridge port that is causing the bridge port’s MAC_Operational parameter to be false.
 - IngBlocked – The ingress port can be identified, but the target data frame was not forwarded when received on this port due to active topology management, i.e., the bridge port is not in the forwarding state.
 - IngVid – The ingress port is not in the member set of the LTM’s VIDs, and ingress filtering is enabled, so the target data frame was filtered by ingress filtering.
- ◆ **Egress Action** – Action taken on the egress port:
 - EgrOk – The targeted data frame was forwarded.
 - EgrDown – The Egress Port can be identified, but that bridge port’s MAC_Operational parameter is false.
 - EgrBlocked – The egress port can be identified, but the data frame was not passed through the egress port due to active topology management, i.e., the bridge port is not in the forwarding state.
 - EgrVid – The Egress Port can be identified, but the bridge port is not in the LTM’s VID member set, and was therefore filtered by egress filtering.
- ◆ **Reply** – Reply action:
 - FDB – Target address found in forwarding database.
 - MPDB – Target address found in the maintenance point database.
 - HIT – Target located on this device.

WEB INTERFACE

To show information about link trace operations launched from this device:

1. Click Administration, CFM.
2. Select Show Information from the Step list.
3. Select Show Link Trace Cache from the Action list.

Figure 316: Showing the Link Trace Cache

Hops	MA	IP/Alias Address	Forwarded	Ingress MAC Address	Egress MAC Address	Ingress Action	Egress Action	Reply
1	denver	11-11-11-11-11-11	Forwarded	11-11-11-11-11-12	11-11-11-11-11-13	OK	OK	FDB
2	boston	AA-BB-CC-00-04-00	Not Forwarded					

DISPLAYING FAULT NOTIFICATION SETTINGS

Use the Administration > CFM > Show Information (Show Fault Notification Generator) page to display configuration settings for the fault notification generator.

CLI REFERENCES

- ◆ ["show ethernet cfm fault-notify-generator" on page 1385](#)

PARAMETERS

These parameters are displayed:

- ◆ **MEP ID** – Maintenance end point identifier.
- ◆ **MD Name** – Maintenance domain name.
- ◆ **MA Name** – Maintenance association name.
- ◆ **Highest Defect** – The highest defect that will generate a fault alarm. (This is disabled by default.)
- ◆ **Lowest Alarm** – The lowest defect that will generate a fault alarm¹⁵.
- ◆ **Alarm Time** – The time a defect must exist before a fault alarm is issued¹⁵.
- ◆ **Reset Time** – The time after a fault alarm has been issued, and no defect exists, before another fault alarm can be issued¹⁵.

15. See ["Configuring CFM Maintenance Domains" on page 527](#).

WEB INTERFACE

To show configuration settings for the fault notification generator:

1. Click Administration, CFM.
2. Select Show Information from the Step list.
3. Select Show Fault Notification Generator from the Action list.

Figure 317: Showing Settings for the Fault Notification Generator

Administration > CFM						
Step: 10. Show Information		Action: Show Fault Notification Generator				
CFM Fault Notification Generator Information Total: 1						
MEP ID	MD Name	MA Name	Highest Defect	Lowest Alarm	Alarm Time (sec)	Reset Time (sec)
1	aa	bb	NONE	allDef	3	3

DISPLAYING CONTINUITY CHECK ERRORS

Use the Administration > CFM > Show Information (Show Continuity Check Error) page to display the CFM continuity check errors logged on this device.

CLI REFERENCES

- ◆ ["show ethernet cfm errors" on page 1372](#)
- ◆ ["clear ethernet cfm errors" on page 1371](#)

PARAMETERS

These parameters are displayed:

- ◆ **Level** – Maintenance level associated with this entry.
- ◆ **Primary VLAN** – VLAN in which this error occurred.
- ◆ **MEP ID** – Identifier of remote MEP.
- ◆ **Interface** – Port at which the error was recorded.
- ◆ **Remote MAC** – MAC address of remote MEP.
- ◆ **Reason** – Error types include:
 - LEAK – MA x is associated with a specific VID list¹⁶, one or more of the VIDs in this MA can pass through the bridge port, no MEP is configured facing outward (down) on any bridge port for this MA, and some other MA y, at a higher maintenance level, and associated with at least one of the VID(s) also in MA x, does have a MEP configured on the bridge port.

16. This definition is based on the IEEE 802.1ag standard. Current software for this switch only supports a single VLAN per MA. However, since it may interact with other devices which support multiple VLAN assignments per MA, this error message may be reported.

- VIDS – MA x is associated with a specific VID list¹⁶, an MEP is configured facing inward (up) on this MA on the bridge port, and some other MA y, associated with at least one of the VID(s) also in MA x, also has an Up MEP configured facing inward (up) on some bridge port.
 - EXCESS_LEV – The number of different MD levels at which MIPs are to be created on this port exceeds the bridge's capabilities.
 - OVERLAP_LEV – A MEP is created for one VID at one maintenance level, but a MEP is configured on another VID at an equivalent or higher level, exceeding the bridge's capabilities.
- ◆ **MA Name** – The maintenance association for this entry.

WEB INTERFACE

To show CFM continuity check errors:

1. Click Administration, CFM.
2. Select Show Information from the Step list.
3. Select Show Continuity Check Error from the Action list.

Figure 318: Showing Continuity Check Errors

Level	Primary VLAN	MEP ID	Interface	Remote MAC	Reason	MA Name
5	2	40	Unit 1 / Port 10	00-01-02-03-04-05	LEAK	aa

OAM CONFIGURATION

The switch provides OAM (Operation, Administration, and Maintenance) remote management tools required to monitor and maintain the links to subscriber CPEs (Customer Premise Equipment). This section describes functions including enabling OAM for selected ports, loopback testing, and displaying remote device information.

ENABLING OAM ON LOCAL PORTS

Use the Administration > OAM > Interface page to enable OAM functionality on the selected port. Not all CPEs support operation and maintenance functions, so OAM is therefore disabled by default. If a CPE supports OAM, this functionality must first be enabled on the connected port to gain access to the configuration functions provided under the OAM menu.

CLI REFERENCES

- ◆ "OAM Commands" on page 1389

PARAMETERS

These parameters are displayed:

- ◆ **Port** – Port identifier. (Range: 1-28/52)
- ◆ **Admin Status** – Enables or disables OAM functions. (Default: Disabled)
- ◆ **Operation State** – Shows the operational state between the local and remote OAM devices. This value is always "disabled" if OAM is disabled on the local interface.

Table 38: OAM Operation State

State	Description
Disabled	OAM is disabled on this interface via the OAM Admin Status.
Link Fault	The link has detected a fault or the interface is not operational.
Passive Wait	This value is returned only by OAM entities in passive mode and indicates the OAM entity is waiting to see if the peer device is OAM capable.
Active Send Local	This value is used by active mode devices and indicates the OAM entity is actively trying to discover whether the peer has OAM capability but has not yet made that determination.
Send Local And Remote	The local OAM entity has discovered the peer but has not yet accepted or rejected the configuration of the peer.
Send Local And Remote OK	OAM peering is allowed by the local device.
OAM Peering Locally Rejected	The local OAM entity rejects the peering.
OAM Peering Remotely Rejected	The remote OAM entity rejects the peering.
Operational	When the local OAM entity learns that both it and the remote OAM entity have accepted the peering, the state moves to this state.
Non Oper Half Duplex	This state is returned whenever Ethernet OAM is enabled but the interface is in half-duplex operation.

- ◆ **Mode** – Sets the OAM operation mode. (Default: Active)
 - **Active** – All OAM functions are enabled.
 - **Passive** – All OAM functions are enabled, except for OAM discovery, sending variable request OAMPDUs, and sending loopback control OAMPDUs.

- ◆ **Critical Link Event** – Controls reporting of critical link events to its OAM peer.
 - **Dying Gasp** – If an unrecoverable condition occurs, the local OAM entity (i.e., this switch) indicates this by immediately sending a trap message. (Default: Enabled)

Dying gasp events are caused by an unrecoverable failure, such as a power failure or device reset.



NOTE: When system power fails, the switch will always send a dying gasp trap message prior to power down.

- **Critical Event** – If a critical event occurs, the local OAM entity indicates this to its peer by setting the appropriate flag in the next OAMPDU to be sent and stores this information in its OAM event log. (Default: Enabled)

Critical events include various failures, such as abnormal voltage fluctuations, out-of-range temperature detected, fan failure, CRC error in flash memory, insufficient memory, or other hardware faults.
- ◆ **Errored Frame** – Controls reporting of errored frame link events.

An errored frame is a frame in which one or more bits are errored.

An errored frame link event occurs if the threshold is reached or exceeded within the specified period.

If reporting is enabled and an errored frame link event occurs, the local OAM entity (this switch) sends an Event Notification OAMPDU to the remote OAM entity. The Errored Frame Event TLV includes the number of errored frames detected during the specified period.
 - **Status** – Enables reporting of errored frame link events. (Default: Enabled)
 - **Window Size** – The period of time in which to check the reporting threshold for errored frame link events. (Range: 10-65535 in units of 10 milliseconds; Default: 10 units of 10 milliseconds, or the equivalent of 1 second)
 - **Threshold Count** – The threshold for errored frame link events. (Range: 1-65535; Default: 1)

WEB INTERFACE

To enable OAM functionality on the selected port:

1. Click Administration, OAM, Interface.
2. Set the OAM administrative status and operational mode for the required ports. Specify whether or not critical link events will be reported by the switch. Specify whether errored frame link events will be reported, as well as the required window size and threshold.

3. Click Apply.

Figure 319: Enabling OAM for Local Ports

Administration > OAM > Interface

OAM Port List Total: 52

Port	Admin Status	Operation State	Mode	Critical Link Event		Errored Frame		
				Dying Gasp	Critical Event	Status	Window Size (10-65535 1/10 sec)	Threshold Count (1-65535)
1	<input type="checkbox"/> Enabled	Link Fault	Active	<input checked="" type="checkbox"/> Enabled	<input checked="" type="checkbox"/> Enabled	<input checked="" type="checkbox"/> Enabled	10	1
2	<input type="checkbox"/> Enabled	Link Fault	Active	<input checked="" type="checkbox"/> Enabled	<input checked="" type="checkbox"/> Enabled	<input checked="" type="checkbox"/> Enabled	10	1
3	<input type="checkbox"/> Enabled	Disabled	Active	<input checked="" type="checkbox"/> Enabled	<input checked="" type="checkbox"/> Enabled	<input checked="" type="checkbox"/> Enabled	10	1
4	<input type="checkbox"/> Enabled	Disabled	Active	<input checked="" type="checkbox"/> Enabled	<input checked="" type="checkbox"/> Enabled	<input checked="" type="checkbox"/> Enabled	10	1
5	<input type="checkbox"/> Enabled	Disabled	Active	<input checked="" type="checkbox"/> Enabled	<input checked="" type="checkbox"/> Enabled	<input checked="" type="checkbox"/> Enabled	10	1
6	<input type="checkbox"/> Enabled	Disabled	Active	<input checked="" type="checkbox"/> Enabled	<input checked="" type="checkbox"/> Enabled	<input checked="" type="checkbox"/> Enabled	10	1
7	<input type="checkbox"/> Enabled	Link Fault	Active	<input checked="" type="checkbox"/> Enabled	<input checked="" type="checkbox"/> Enabled	<input checked="" type="checkbox"/> Enabled	10	1
8	<input type="checkbox"/> Enabled	Disabled	Active	<input checked="" type="checkbox"/> Enabled	<input checked="" type="checkbox"/> Enabled	<input checked="" type="checkbox"/> Enabled	10	1
9	<input type="checkbox"/> Enabled	Disabled	Active	<input checked="" type="checkbox"/> Enabled	<input checked="" type="checkbox"/> Enabled	<input checked="" type="checkbox"/> Enabled	10	1
10	<input type="checkbox"/> Enabled	Disabled	Active	<input checked="" type="checkbox"/> Enabled	<input checked="" type="checkbox"/> Enabled	<input checked="" type="checkbox"/> Enabled	10	1

Apply Revert

DISPLAYING STATISTICS FOR OAM MESSAGES

Use the Administration > OAM > Counters page to display statistics for the various types of OAM messages passed across each port.

CLI REFERENCES

- ◆ "show efm oam counters interface" on page 1397
- ◆ "clear efm oam counters" on page 1394

PARAMETERS

These parameters are displayed:

- ◆ **Port** – Port identifier. (Range: 1-28/52)
- ◆ **Clear** – Clears statistical counters for the selected ports.
- ◆ **OAMPDU** – Message types transmitted and received by the OAM protocol, including Information OAMPDUs, unique Event OAMPDUs, Loopback Control OAMPDUs, and Organization Specific OAMPDUs.

WEB INTERFACE

To display statistics for OAM messages:

1. Click Administration, OAM, Counters.

Figure 320: Displaying Statistics for OAM Messages

The screenshot shows a web interface titled "Administration > OAM > Counters". Below the title, it says "OAM Port Counters Total: 52". There are navigation buttons 1 through 6. The main table is titled "OAMPDU" and has the following structure:

Port	Information		Event Notification		Loopback Control		Organization Specific	
	Transmitted	Received	Transmitted	Received	Transmitted	Received	Transmitted	Received
1	0	0	0	0	0	0	0	0
2	0	0	0	0	0	0	0	0
3	0	0	0	0	0	0	0	0
4	0	0	0	0	0	0	0	0
5	0	0	0	0	0	0	0	0
6	0	0	0	0	0	0	0	0
7	0	0	0	0	0	0	0	0
8	0	0	0	0	0	0	0	0
9	0	0	0	0	0	0	0	0
10	0	0	0	0	0	0	0	0

At the bottom of the table is a "Clear" button.

DISPLAYING THE OAM EVENT LOG

Use the Administration > OAM > Event Log page to display link events for the selected port.

CLI REFERENCES

- ◆ "show efm oam event-log interface" on page 1397

COMMAND USAGE

- ◆ When a link event occurs, no matter whether the location is local or remote, this information is entered in OAM event log.
- ◆ When the log system becomes full, older events are automatically deleted to make room for new entries.
- ◆ The time of locally generated events can be accurately retrieved from the sysUpTime variable. For remotely generated events, the time of an event is indicated by the reception of an Event Notification OAMPDU from the peer.

WEB INTERFACE

To display link events for the selected port:

1. Click Administration, OAM, Event Log.
2. Select a port from the drop-down list.

Figure 321: Displaying the OAM Event Log

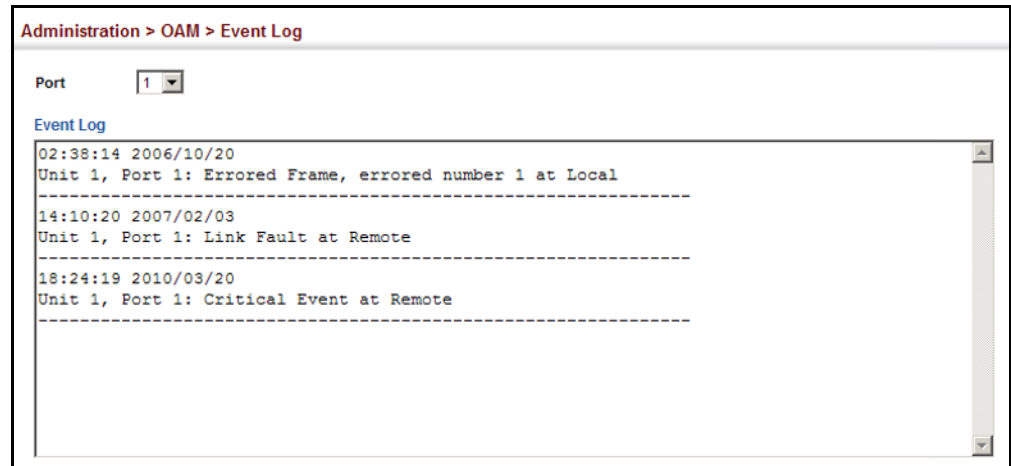

DISPLAYING THE STATUS OF REMOTE INTERFACES

Use the Administration > OAM > Remote Interface page to display information about attached OAM-enabled devices.

CLI REFERENCES

- ◆ "show efm oam status remote interface" on page 1400

PARAMETERS

These parameters are displayed:

- ◆ **Port** – Port identifier. (Range: 1-28/52)
- ◆ **MAC Address** – MAC address of the OAM peer.
- ◆ **OUI** – Organizational Unit Identifier of the OAM peer.
- ◆ **Remote Loopback** – Shows if remote loopback is supported by the OAM peer.
- ◆ **Unidirectional Function** – Shows if this function is supported by the OAM peer.

If supported, this indicates that the OAM entity supports the transmission of OAMPDUs on links that are operating in unidirectional mode (where traffic flows in one direction only). Some newer physical layer devices support the optional ability to encode and transmit data while one direction of the link is non-operational. This function allows OAM remote fault indication during fault conditions. This switch does not support the unidirectional function, but can parse error messages sent from a peer with unidirectional capability.
- ◆ **Link Monitor** – Shows if the OAM entity can send and receive Event Notification OAMPDUs.
- ◆ **MIB Variable Retrieval** – Shows if the OAM entity can send and receive Variable Request and Response OAMPDUs.

WEB INTERFACE

To display information about attached OAM-enabled devices:

1. Click Administration, OAM, Remote Interface.

Figure 322: Displaying Status of Remote Interfaces

Administration > OAM > Remote Interface

OAM Remote Port List Total: 52

Port	MAC Address	OUI	Remote Loopback	Unidirectional Function	Link Monitor	MIB Variable Retrieval
1	00-00-00-00-00-00	00-00-00	Disabled	Disabled	Disabled	Disabled
2	00-00-00-00-00-00	00-00-00	Disabled	Disabled	Disabled	Disabled
3	00-00-00-00-00-00	00-00-00	Disabled	Disabled	Disabled	Disabled
4	00-00-00-00-00-00	00-00-00	Disabled	Disabled	Disabled	Disabled
5	00-00-00-00-00-00	00-00-00	Disabled	Disabled	Disabled	Disabled
6	00-00-00-00-00-00	00-00-00	Disabled	Disabled	Disabled	Disabled
7	00-00-00-00-00-00	00-00-00	Disabled	Disabled	Disabled	Disabled
8	00-00-00-00-00-00	00-00-00	Disabled	Disabled	Disabled	Disabled
9	00-00-00-00-00-00	00-00-00	Disabled	Disabled	Disabled	Disabled
10	00-00-00-00-00-00	00-00-00	Disabled	Disabled	Disabled	Disabled

CONFIGURING A REMOTE LOOP BACK TEST

Use the Administration > OAM > Remote Loopback (Remote Loopback Test) page to initiate a loop back test to the peer device attached to the selected port.

CLI REFERENCES

- ◆ "efm oam remote-loopback" on page 1395
- ◆ "efm oam remote-loopback test" on page 1396

COMMAND USAGE

- You can use this command to perform an OAM remote loop back test on the specified port. The port that you specify to run this test must be connected to a peer OAM device capable of entering into OAM remote loop back mode.
- ◆ During a remote loop back test, the remote OAM entity loops back every frame except for OAMPDUs and pause frames.
- ◆ OAM remote loopback can be used for fault localization and link performance testing. Statistics from both the local and remote DTE can be queried and compared at any time during loop back testing.
- ◆ To perform a loopback test, first enable Remote Loop Back Mode, click Test, and then click End. The number of packets transmitted and received will be displayed.

PARAMETERS

These parameters are displayed:

Loopback Mode of Remote Device

- ◆ **Port** – Port identifier. (Range: 1-28/52)

- ◆ **Loopback Mode** – Shows if loop back mode is enabled on the peer. This attribute must be enabled before starting the loopback test.
- ◆ **Loopback Status** – Shows if loopback testing is currently running.

Loopback Test Parameters

- ◆ **Packets Number** – Number of packets to send. (Range: 1-99999999; Default: 10000)
- ◆ **Packet Size** – Size of packets to send. (Range: 64-1518 bytes; Default: 64 bytes)
- ◆ **Test** – Starts the loop back test.
- ◆ **End** – Stops the loop back test.

Loop Back Status of Remote Device

- ◆ **Result** – Shows the loop back status on the peer. The loop back states shown in this field are described below.

Table 39: OAM Operation State

State	Description
No Loopback	Operating in normal mode with no loopback in progress.
Initiating Loopback	The local OAM entity is starting the loopback process with its peer. It has yet to receive any acknowledgement that the remote OAM entity has received its loopback command request.
Remote Loopback	The local OAM client knows that the remote OAM entity is in loopback mode.
Terminating Loopback	The local OAM client is in the process of terminating the remote loopback.
Local Loopback	The remote OAM client has put the local OAM entity in loopback mode.
Unknown	This status may be returned if the OAM loopback is in a transition state but should not persist.

- **Packets Transmitted** – The number of loop back frames transmitted during the last loopback test on this interface.
- **Packets Received** – The number of loop back frames received during the last loopback test on this interface.
- **Loss Rate** – The percentage of packets for which there was no response.

WEB INTERFACE

To initiate a loop back test to the peer device attached to the selected port:

1. Click Administration, OAM, Remote Loop Back.
2. Select Remote Loopback Test from the Action list.

3. Select the port on which to initiate remote loop back testing, enable the Loop Back Mode attribute, and click Apply.
4. Set the number of packets to send and the packet size, and then click Test.

Figure 323: Running a Remote Loop Back Test

Administration > OAM > Remote Loopback

Action: Remote Loopback Test

Port: 2

Loopback Mode: Enabled

Loopback Status: Remote Loopback

Apply Revert

Packet Number (1-99999999):

Packet Size (64-1518) bytes

Test End

Result

10 packets transmitted. 10 packets received. Loss rate is 0.00 %

DISPLAYING RESULTS OF REMOTE LOOP BACK TESTING

Use the Administration > OAM > Remote Loop Back (Show Test Result) page to display the results of remote loop back testing for each port for which this information is available.

CLI REFERENCES

- ◆ ["show efm oam remote-loopback interface" on page 1399](#)

PARAMETERS

These parameters are displayed:

- ◆ **Port** – Port identifier. (Range: 1-28/52)
- ◆ **Packets Transmitted** – The number of loop back frames transmitted during the last loop back test on this interface.
- ◆ **Packets Received** – The number of loop back frames received during the last loop back test on this interface.
- ◆ **Loss Rate** – The percentage of packets transmitted for which there was no response.

WEB INTERFACE

To display the results of remote loop back testing for each port for which this information is available:

1. Click Administration, OAM, Remote Loop Back.
2. Select Show Test Result from the Action list.

Figure 324: Displaying the Results of Remote Loop Back Testing

The screenshot shows a web interface with the breadcrumb 'Administration > OAM > Remote Loopback'. Below the breadcrumb is an 'Action:' dropdown menu set to 'Show Test Result'. The main content is a table titled 'Port Remote Test Result List' with a 'Total: 52' and a pagination control showing '1' selected. The table has four columns: 'Port', 'Packets Transmitted', 'Packets Received', and 'Loss Rate'. The data rows show ports 1 through 10, all with 0 packets transmitted and received, and a 0.00% loss rate.

Port	Packets Transmitted	Packets Received	Loss Rate
1	0	0	0.00 %
2	0	0	0.00 %
3	0	0	0.00 %
4	0	0	0.00 %
5	0	0	0.00 %
6	0	0	0.00 %
7	0	0	0.00 %
8	0	0	0.00 %
9	0	0	0.00 %
10	0	0	0.00 %

This chapter describes how to configure the following multicast services:

- ◆ [IGMP Snooping](#) – Configures snooping and query parameters.
- ◆ [Filtering and Throttling](#) – Filters specified multicast service, or throttles the maximum of multicast groups allowed on an interface.
- ◆ [MLD Snooping](#) – Configures snooping and query parameters for IPv6.
- ◆ [Multicast VLAN Registration for IPv4](#) – Configures a single network-wide multicast VLAN shared by hosts residing in other standard or private VLAN groups, preserving security and data isolation.
- ◆ [Multicast VLAN Registration for IPv6](#) – Configures a single network-wide multicast VLAN shared by hosts residing in other standard or private VLAN groups, preserving security and data isolation.

OVERVIEW

Multicasting is used to support real-time applications such as video conferencing or streaming audio. A multicast server does not have to establish a separate connection with each client. It merely broadcasts its service to the network, and any hosts that want to receive the multicast register with their local multicast switch/router. Although this approach reduces the network overhead required by a multicast server, the broadcast traffic must be carefully pruned at every multicast switch/router it passes through to ensure that traffic is only passed on to the hosts which subscribed to this service.

Figure 325: Multicast Filtering Concept

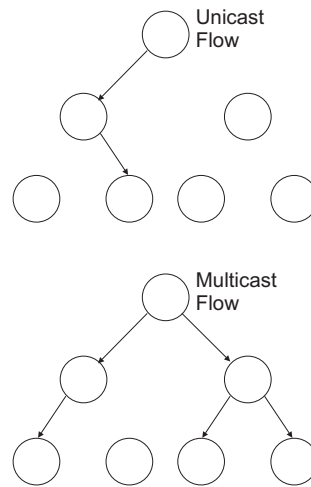

This switch can use Internet Group Management Protocol (IGMP) to filter multicast traffic. IGMP Snooping can be used to passively monitor or “snoop” on exchanges between attached hosts and an IGMP-enabled device, most commonly a multicast router. In this way, the switch can discover the ports that want to join a multicast group, and set its filters accordingly.

If there is no multicast router attached to the local subnet, multicast traffic and query messages may not be received by the switch. In this case (Layer 2) IGMP Query can be used to actively ask the attached hosts if they want to receive a specific multicast service. IGMP Query thereby identifies the ports containing hosts requesting to join the service and sends data out to those ports only. It then propagates the service request up to any neighboring multicast switch/router to ensure that it will continue to receive the multicast service.

The purpose of IP multicast filtering is to optimize a switched network’s performance, so multicast packets will only be forwarded to those ports containing multicast group hosts or multicast routers/switches, instead of flooding traffic to all ports in the subnet (VLAN).

You can also configure a single network-wide multicast VLAN shared by hosts residing in other standard or private VLAN groups, preserving security and data isolation ["Multicast VLAN Registration for IPv4" on page 603](#).

LAYER 2 IGMP (SNOOPING AND QUERY FOR IPv4)

IGMP Snooping and Query – If multicast routing is not supported on other switches in your network, you can use IGMP Snooping and IGMP Query ([page 570](#)) to monitor IGMP service requests passing between multicast clients and servers, and dynamically configure the switch ports which need to forward multicast traffic. IGMP Snooping conserves bandwidth on

network segments where no node has expressed interest in receiving a specific multicast service. For switches that do not support multicast routing, or where multicast routing is already enabled on other switches in the local network segment, IGMP Snooping is the only service required to support multicast filtering.

When using IGMPv3 snooping, service requests from IGMP Version 1, 2 or 3 hosts are all forwarded to the upstream router as IGMPv3 reports. The primary enhancement provided by IGMPv3 snooping is in keeping track of information about the specific multicast sources which downstream IGMPv3 hosts have requested or refused¹⁷. The switch maintains information about both multicast groups and channels, where a group indicates a multicast flow for which the hosts have *not* requested a specific source (the only option for IGMPv1 and v2 hosts unless statically configured on the switch), and a channel indicates a flow for which the hosts have requested service from a specific source. For IGMPv1/v2 hosts, the source address of a channel is always null (indicating that any source is acceptable), but for IGMPv3 hosts, it may include a specific address when requested.

Only IGMPv3 hosts can request service from a specific multicast source. When downstream hosts request service from a specific source for a multicast service, these sources are all placed in the Include list, and traffic is forwarded to the hosts from each of these sources. IGMPv3 hosts may also request that service be forwarded from any source except for those specified. In this case, traffic is filtered from sources in the Exclude list, and forwarded from all other available sources.



NOTE: When the switch is configured to use IGMPv3 snooping, the snooping version may be downgraded to version 2 or version 1, depending on the version of the IGMP query packets detected on each VLAN.

NOTE: IGMP snooping will not function unless a multicast router port is enabled on the switch. This can be accomplished in one of two ways. A static router port can be manually configured (see "[Specifying Static Interfaces for a Multicast Router](#)" on page 574). Using this method, the router port is never timed out, and will continue to function until explicitly removed. The other method relies on the switch to dynamically create multicast routing ports whenever multicast routing protocol packets or IGMP query packets are detected on a port.

NOTE: A maximum of up to 1023 multicast entries can be maintained for IGMP snooping. Once the table is full, no new entries are learned. Any subsequent multicast traffic not found in the table is dropped if unregistered-flooding is disabled (default behavior) and no router port is configured in the attached VLAN, or flooded throughout the VLAN if unregistered-flooding is enabled (see "[Configuring IGMP Snooping and Query Parameters](#)" on page 570).

Static IGMP Router Interface – If IGMP snooping cannot locate the IGMP querier, you can manually designate a known IGMP querier (i.e., a multicast router/switch) connected over the network to an interface on

17. Source IP lists is not supported in IGMPv3 reports by the switch due to an ASIC limitation.

your switch (page 574). This interface will then join all the current multicast groups supported by the attached router/switch to ensure that multicast traffic is passed to all appropriate interfaces within the switch.

Static IGMP Host Interface – For multicast applications that you need to control more carefully, you can manually assign a multicast service to specific interfaces on the switch (page 576).

IGMP Snooping with Proxy Reporting – The switch supports last leave, and query suppression (as defined in DSL Forum TR-101, April 2006):

- ◆ When proxy reporting is disabled, all IGMP reports received by the switch are forwarded natively to the upstream multicast routers.
- ◆ Last Leave: Intercepts, absorbs and summarizes IGMP leaves coming from IGMP hosts. IGMP leaves are relayed upstream only when necessary, that is, when the last user leaves a multicast group.
- ◆ Query Suppression: Intercepts and processes IGMP queries in such a way that IGMP specific queries are never sent to client ports.

The only deviation from TR-101 is that the marking of IGMP traffic initiated by the switch with priority bits as defined in R-250 is not supported.

CONFIGURING IGMP SNOOPING AND QUERY PARAMETERS

Use the Multicast > IGMP Snooping > General page to configure the switch to forward multicast traffic intelligently. Based on the IGMP query and report messages, the switch forwards multicast traffic only to the ports that request it. This prevents the switch from broadcasting the traffic to all ports and possibly disrupting network performance.

CLI REFERENCES

- ◆ "IGMP Snooping" on page 1226

COMMAND USAGE

- ◆ **IGMP Snooping** – This switch can passively snoop on IGMP Query and Report packets transferred between IP multicast routers/switches and IP multicast host groups to identify the IP multicast group members. It simply monitors the IGMP packets passing through it, picks out the group registration information, and configures the multicast filters accordingly.



NOTE: If unknown multicast traffic enters a VLAN which has been configured with a router port, the traffic is forwarded to that port. However, if no router port exists on the VLAN, the traffic is dropped if unregistered data flooding is disabled (default behavior), or flooded throughout the VLAN if unregistered data flooding is enabled (see "Unregistered Data Flooding" in the Command Attributes section).

- ◆ **IGMP Querier** – A router, or multicast-enabled switch, can periodically ask their hosts if they want to receive multicast traffic. If there is more than one router/switch on the LAN performing IP multicasting, one of

these devices is elected “querier” and assumes the role of querying the LAN for group members. It then propagates the service requests on to any upstream multicast switch/router to ensure that it will continue to receive the multicast service.



NOTE: Multicast routers use this information from IGMP snooping and query reports, along with a multicast routing protocol such as DVMRP or PIM, to support IP multicasting across the Internet.

PARAMETERS

These parameters are displayed:

- ◆ **IGMP Snooping Status** – When enabled, the switch will monitor network traffic to determine which hosts want to receive multicast traffic. This is referred to as IGMP Snooping. (Default: Enabled)

When IGMP snooping is enabled globally, the per VLAN interface settings for IGMP snooping take precedence (see ["Setting IGMP Snooping Status per Interface" on page 578](#)).

When IGMP snooping is disabled globally, snooping can still be configured per VLAN interface, but the interface settings will not take effect until snooping is re-enabled globally.

- ◆ **Proxy Reporting Status** – Enables IGMP Snooping with Proxy Reporting. (Default: Disabled)

When proxy reporting is enabled with this command, the switch performs “IGMP Snooping with Proxy Reporting” (as defined in DSL Forum TR-101, April 2006), including last leave, and query suppression.

Last leave sends out a proxy query when the last member leaves a multicast group, and query suppression means that specific queries are not forwarded from an upstream multicast router to hosts downstream from this device.

When proxy reporting is disabled, all IGMP reports received by the switch are forwarded natively to the upstream multicast routers.

- ◆ **TCN Flood** – Enables flooding of multicast traffic if a spanning tree topology change notification (TCN) occurs. (Default: Disabled)

When a spanning tree topology change occurs, the multicast membership information learned by switch may be out of date. For example, a host linked to one port before the topology change (TC) may be moved to another port after the change. To ensure that multicast data is delivered to all receivers, by default, a switch in a VLAN (with IGMP snooping enabled) that receives a Bridge Protocol Data Unit (BPDU) with TC bit set (by the root bridge) will enter into “multicast flooding mode” for a period of time until the topology has stabilized and the new locations of all multicast receivers are learned.

If a topology change notification (TCN) is received, and all the uplink ports are subsequently deleted, a time out mechanism is used to delete all of the currently learned multicast channels.

When a new uplink port starts up, the switch sends unsolicited reports for all currently learned channels out the new uplink port.

By default, the switch immediately enters into “multicast flooding mode” when a spanning tree topology change occurs. In this mode, multicast traffic will be flooded to all VLAN ports. If many ports have subscribed to different multicast groups, flooding may cause excessive packet loss on the link between the switch and the end host. Flooding may be disabled to avoid this, causing multicast traffic to be delivered only to those ports on which multicast group members have been learned. Otherwise, the time spent in flooding mode can be manually configured to reduce excessive loading.

When the spanning tree topology changes, the root bridge sends a proxy query to quickly re-learn the host membership/port relations for multicast channels. The root bridge also sends an unsolicited Multicast Router Discover (MRD) request to quickly locate the multicast routers in this VLAN.

The proxy query and unsolicited MRD request are flooded to all VLAN ports except for the receiving port when the switch receives such packets.

- ◆ **TCN Query Solicit** – Sends out an IGMP general query solicitation when a spanning tree topology change notification (TCN) occurs. (Default: Disabled)

When the root bridge in a spanning tree receives a TCN for a VLAN where IGMP snooping is enabled, it issues a global IGMP leave message (or query solicitation). When a switch receives this solicitation, it floods it to all ports in the VLAN where the spanning tree change occurred. When an upstream multicast router receives this solicitation, it immediately issues an IGMP general query.

A query solicitation can be sent whenever the switch notices a topology change, even if it is not the root bridge in spanning tree.

- ◆ **Router Alert Option** – Discards any IGMPv2/v3 packets that do not include the Router Alert option. (Default: Disabled)

As described in Section 9.1 of RFC 3376 for IGMP Version 3, the Router Alert Option can be used to protect against DOS attacks. One common method of attack is launched by an intruder who takes over the role of querier, and starts overloading multicast hosts by sending a large number of group-and-source-specific queries, each with a large source list and the Maximum Response Time set to a large value.

To protect against this kind of attack, (1) routers should not forward queries. This is easier to accomplish if the query carries the Router Alert option. (2) Also, when the switch is acting in the role of a multicast host (such as when using proxy routing), it should ignore version 2 or 3 queries that do not contain the Router Alert option.

- ◆ **Unregistered Data Flooding** – Floods unregistered multicast traffic into the attached VLAN. (Default: Disabled)

Once the table used to store multicast entries for IGMP snooping and multicast routing is filled, no new entries are learned. If no router port

is configured in the attached VLAN, and unregistered-flooding is disabled, any subsequent multicast traffic not found in the table is dropped, otherwise it is flooded throughout the VLAN.

- ◆ **Forwarding Priority** – Assigns a CoS priority to all multicast traffic. (Range: 0-7, where 7 is the highest priority)

This parameter can be used to set a high priority for low-latency multicast traffic such as a video-conference, or to set a low priority for normal multicast traffic not sensitive to latency.
- ◆ **Version Exclusive** – Discards any received IGMP messages which use a version different to that currently configured by the IGMP Version attribute. (Default: Disabled)
- ◆ **IGMP Unsolicited Report Interval** – Specifies how often the upstream interface should transmit unsolicited IGMP reports when proxy reporting is enabled. (Range: 1-65535 seconds, Default: 400 seconds)

When a new upstream interface (that is, uplink port) starts up, the switch sends unsolicited reports for all currently learned multicast channels via the new upstream interface.

This command only applies when proxy reporting is enabled.
- ◆ **Router Port Expire Time** – The time the switch waits after the previous querier stops before it considers it to have expired. (Range: 1-65535, Recommended Range: 300-500 seconds, Default: 300)
- ◆ **IGMP Snooping Version** – Sets the protocol version for compatibility with other devices on the network. This is the IGMP Version the switch uses to send snooping reports. (Range: 1-3; Default: 2)

This attribute configures the IGMP report/query version used by IGMP snooping. Versions 1 - 3 are all supported, and versions 2 and 3 are backward compatible, so the switch can operate with other devices, regardless of the snooping version employed.
- ◆ **Querier Status** – When enabled, the switch can serve as the Querier, which is responsible for asking hosts if they want to receive multicast traffic. (Default: Disabled)

WEB INTERFACE

To configure general settings for IGMP Snooping and Query:

1. Click Multicast, IGMP Snooping, General.
2. Adjust the IGMP settings as required.
3. Click Apply.

Figure 326: Configuring General Settings for IGMP Snooping

Multicast > IGMP Snooping > General

IGMP Snooping Status	<input checked="" type="checkbox"/> Enabled
Proxy Reporting Status	<input type="checkbox"/> Enabled
TCN Flood	<input type="checkbox"/> Enabled
TCN Query Solicit	<input type="checkbox"/> Enabled
Router Alert Option	<input type="checkbox"/> Enabled
Unregistered Data Flooding	<input type="checkbox"/> Enabled
Forwarding Priority (0-7)	<input type="checkbox"/> <input type="text"/>
Version Exclusive	<input type="checkbox"/> Enabled
IGMP Unsolicited Report Interval (1-65535)	<input type="text" value="400"/> seconds
Router Port Expire Time (1-65535)	<input type="text" value="300"/> seconds
IGMP Snooping Version (1-3)	<input type="text" value="2"/>
Querier Status	<input type="checkbox"/> Enabled

Apply Revert

SPECIFYING STATIC INTERFACES FOR A MULTICAST ROUTER

Use the Multicast > IGMP Snooping > Multicast Router (Add Static Multicast Router) page to statically attach an interface to a multicast router/switch.

Depending on network connections, IGMP snooping may not always be able to locate the IGMP querier. Therefore, if the IGMP querier is a known multicast router/switch connected over the network to an interface (port or trunk) on the switch, the interface (and a specified VLAN) can be manually configured to join all the current multicast groups supported by the attached router. This can ensure that multicast traffic is passed to all the appropriate interfaces within the switch.

CLI REFERENCES

- ◆ ["Static Multicast Routing" on page 1249](#)

COMMAND USAGE

IGMP Snooping must be enabled globally on the switch (see ["Configuring IGMP Snooping and Query Parameters" on page 570](#)) before a multicast router port can take effect.

PARAMETERS

These parameters are displayed:

Add Static Multicast Router

- ◆ **VLAN** – Selects the VLAN which is to propagate all multicast traffic coming from the attached multicast router. (Range: 1-4094)
- ◆ **Interface** – Activates the Port or Trunk scroll down list.
- ◆ **Port** or **Trunk** – Specifies the interface attached to a multicast router.

Show Static Multicast Router

- ◆ **VLAN** – Selects the VLAN for which to display any configured static multicast routers.
- ◆ **Interface** – Shows the interface to which the specified static multicast routers are attached.

Show Current Multicast Router

- ◆ **VLAN** – Selects the VLAN for which to display any currently active multicast routers.
- ◆ **Interface** – Shows the interface to which an active multicast router is attached.
- ◆ **Type** – Shows if this entry is static or dynamic.
- ◆ **Expire** – Time until this dynamic entry expires.

WEB INTERFACE

To specify a static interface attached to a multicast router:

1. Click Multicast, IGMP Snooping, Multicast Router.
2. Select Add Static Multicast Router from the Action list.
3. Select the VLAN which will forward all the corresponding multicast traffic, and select the port or trunk attached to the multicast router.
4. Click Apply.

Figure 327: Configuring a Static Interface for a Multicast Router

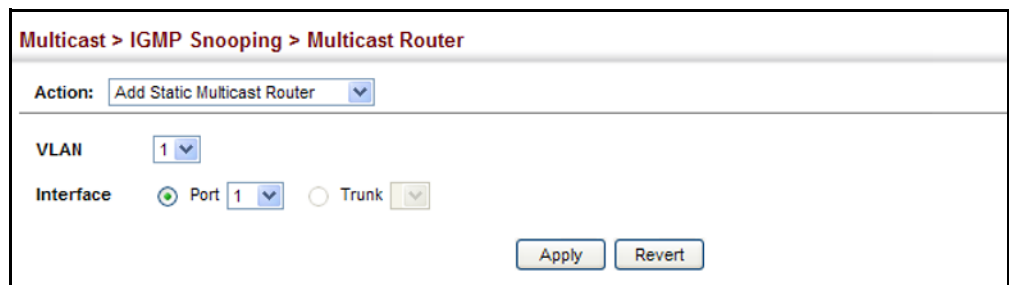

To show the static interfaces attached to a multicast router:

1. Click Multicast, IGMP Snooping, Multicast Router.
2. Select Show Static Multicast Router from the Action list.
3. Select the VLAN for which to display this information.

Figure 328: Showing Static Interfaces Attached a Multicast Router

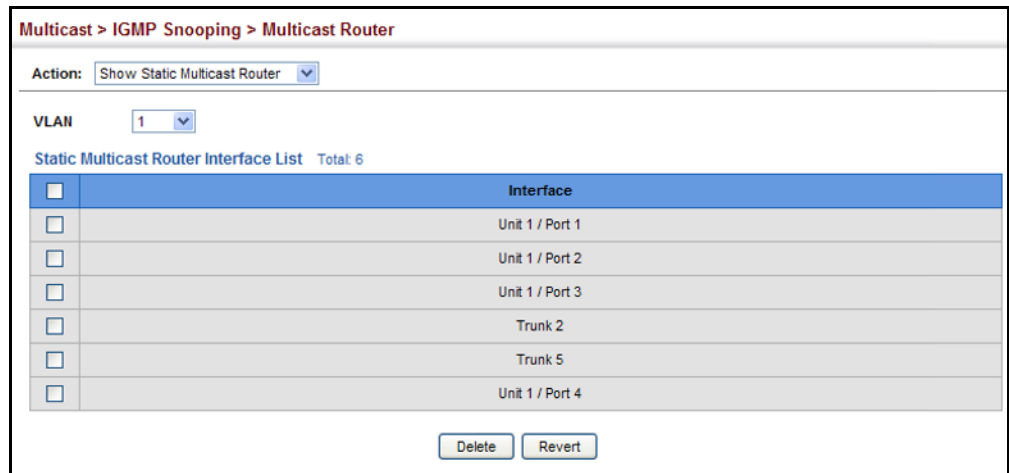

To show the all interfaces attached to a multicast router:

1. Click Multicast, IGMP Snooping, Multicast Router.
2. Select Current Multicast Router from the Action list.
3. Select the VLAN for which to display this information. Ports in the selected VLAN which are attached to a neighboring multicast router/ switch are displayed.

Figure 329: Showing Current Interfaces Attached a Multicast Router

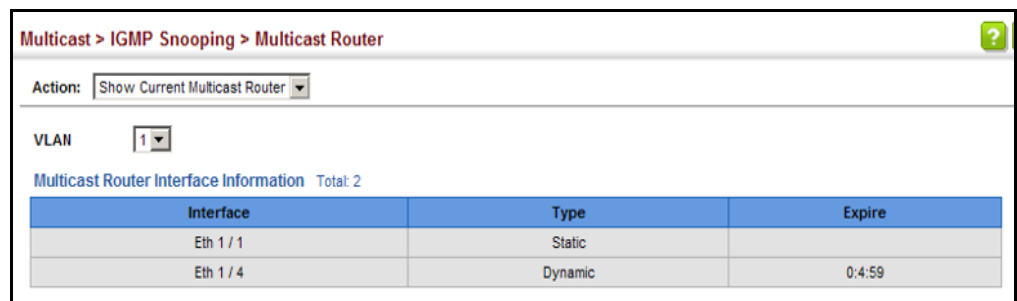

ASSIGNING INTERFACES TO MULTICAST SERVICES

Use the Multicast > IGMP Snooping > IGMP Member (Add Static Member) page to statically assign a multicast service to an interface.

Multicast filtering can be dynamically configured using IGMP Snooping and IGMP Query messages (see ["Configuring IGMP Snooping and Query Parameters" on page 570](#)). However, for certain applications that require tighter control, it may be necessary to statically configure a multicast service on the switch. First add all the ports attached to participating hosts to a common VLAN, and then assign the multicast service to that VLAN group.

CLI REFERENCES

- ◆ ["ip igmp snooping vlan static" on page 1242](#)

COMMAND USAGE

- ◆ Static multicast addresses are never aged out.
- ◆ When a multicast address is assigned to an interface in a specific VLAN, the corresponding traffic can only be forwarded to ports within that VLAN.

PARAMETERS

These parameters are displayed:

- ◆ **VLAN** – Specifies the VLAN which is to propagate the multicast service. (Range: 1-4094)
- ◆ **Interface** – Activates the Port or Trunk scroll down list.
- ◆ **Port** or **Trunk** – Specifies the interface assigned to a multicast group.
- ◆ **Multicast IP** – The IP address for a specific multicast service.

WEB INTERFACE

To statically assign an interface to a multicast service:

1. Click Multicast, IGMP Snooping, IGMP Member.
2. Select Add Static Member from the Action list.
3. Select the VLAN that will propagate the multicast service, specify the interface attached to a multicast service (through an IGMP-enabled switch or multicast router), and enter the multicast IP address.
4. Click Apply.

Figure 330: Assigning an Interface to a Multicast Service

Multicast > IGMP Snooping > IGMP Member

Action: Add Static Member

VLAN: 1

Interface: Port 1 Trunk 1

Multicast IP: 224.1.1.1

Apply Revert

To show the static interfaces assigned to a multicast service:

1. Click Multicast, IGMP Snooping, IGMP Member.
2. Select Show Static Member from the Action list.
3. Select the VLAN for which to display this information.

Figure 331: Showing Static Interfaces Assigned to a Multicast Service

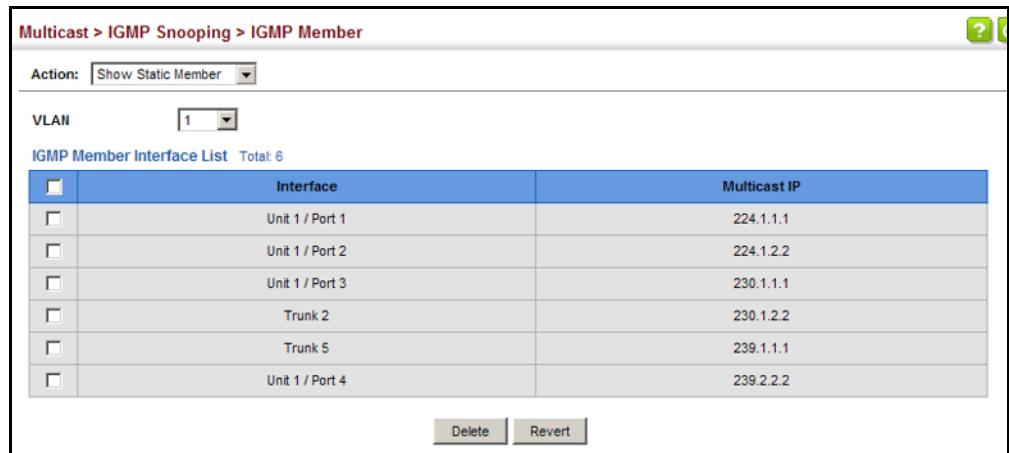

SETTING IGMP SNOOPING STATUS PER INTERFACE

Use the Multicast > IGMP Snooping > Interface (Configure VLAN) page to configure IGMP snooping attributes for a VLAN. To configure snooping globally, refer to "Configuring IGMP Snooping and Query Parameters" on page 570.

CLI REFERENCES

- ◆ "IGMP Snooping" on page 1226

COMMAND USAGE

Multicast Router Discovery

There have been many mechanisms used in the past to identify multicast routers. This has led to interoperability issues between multicast routers and snooping switches from different vendors. In response to this problem, the Multicast Router Discovery (MRD) protocol has been developed for use by IGMP snooping and multicast routing devices. MRD is used to discover which interfaces are attached to multicast routers, allowing IGMP-enabled devices to determine where to send multicast source and group membership messages. (MRD is specified in draft-ietf-magma-mrdisc-07.)

Multicast source data and group membership reports must be received by all multicast routers on a segment. Using the group membership protocol query messages to discover multicast routers is insufficient due to query suppression. MRD therefore provides a standardized way to identify multicast routers without relying on any particular multicast routing protocol.



NOTE: The default values recommended in the MRD draft are implemented in the switch.

Multicast Router Discovery uses the following three message types to discover multicast routers:

- ◆ Multicast Router Advertisement – Advertisements are sent by routers to advertise that IP multicast forwarding is enabled. These messages are sent unsolicited periodically on all router interfaces on which multicast forwarding is enabled. They are sent upon the occurrence of these events:
 - Upon the expiration of a periodic (randomized) timer.
 - As a part of a router's start up procedure.
 - During the restart of a multicast forwarding interface.
 - On receipt of a Solicitation message.
- ◆ Multicast Router Solicitation – Devices send Solicitation messages in order to solicit Advertisement messages from multicast routers. These messages are used to discover multicast routers on a directly attached link. Solicitation messages are also sent whenever a multicast forwarding interface is initialized or re-initialized. Upon receiving a solicitation on an interface with IP multicast forwarding and MRD enabled, a router will respond with an Advertisement.
- ◆ Multicast Router Termination – These messages are sent when a router stops IP multicast routing functions on an interface. Termination messages are sent by multicast routers when:
 - Multicast forwarding is disabled on an interface.
 - An interface is administratively disabled.
 - The router is gracefully shut down.

Advertisement and Termination messages are sent to the All-Snoopers multicast address. Solicitation messages are sent to the All-Routers multicast address.



NOTE: MRD messages are flooded to all ports in a VLAN where IGMP snooping or routing has been enabled. To ensure that older switches which do not support MRD can also learn the multicast router port, the switch floods IGMP general query packets, which do not have a null source address (0.0.0.0), to all ports in the attached VLAN. IGMP packets with a null source address are only flooded to all ports in the VLAN if the system is operating in multicast flooding mode, such as when a new VLAN or new router port is being established, or an spanning tree topology change has occurred. Otherwise, this kind of packet is only forwarded to known multicast routing ports.

PARAMETERS

These parameters are displayed:

- ◆ **VLAN** – ID of configured VLANs. (Range: 1-4094)

- ◆ **IGMP Snooping Status** – When enabled, the switch will monitor network traffic on the indicated VLAN interface to determine which hosts want to receive multicast traffic. This is referred to as IGMP Snooping. (Default: Enabled)

When IGMP snooping is enabled globally (see [page 570](#)), the per VLAN interface settings for IGMP snooping take precedence.

When IGMP snooping is disabled globally, snooping can still be configured per VLAN interface, but the interface settings will not take effect until snooping is re-enabled globally.

- ◆ **Version Exclusive** – Discards any received IGMP messages (except for multicast protocol packets) which use a version different to that currently configured by the IGMP Version attribute. (Default: Disabled)

If version exclusive is disabled on a VLAN, then this setting is based on the global setting configured on the Multicast > IGMP Snooping > General page. If it is enabled on a VLAN, then this setting takes precedence over the global setting.

- ◆ **Immediate Leave Status** – Immediately deletes a member port of a multicast service if a leave packet is received at that port and immediate leave is enabled for the parent VLAN. (Default: Disabled)

If immediate leave is not used, a multicast router (or querier) will send a group-specific query message when an IGMPv2 group leave message is received. The router/querier stops forwarding traffic for that group only if no host replies to the query within the specified time out period. Note that this time out is set to Last Member Query Interval * Robustness Variable (fixed at 2) as defined in RFC 2236.

If immediate leave is enabled, the switch assumes that only one host is connected to the interface. Therefore, immediate leave should only be enabled on an interface if it is connected to only one IGMP-enabled device, either a service host or a neighbor running IGMP snooping.

This attribute is only effective if IGMP snooping is enabled, and IGMPv2 snooping is used.

- ◆ **Multicast Router Discovery** – MRD is used to discover which interfaces are attached to multicast routers. (Default: Disabled)

- ◆ **General Query Suppression** – Suppresses general queries except for ports attached to downstream multicast hosts. (Default: Disabled)

By default, general query messages are flooded to all ports, except for the multicast router through which they are received.

If general query suppression is enabled, then these messages are forwarded only to downstream ports which have joined a multicast service.

- ◆ **Proxy Reporting** – Enables IGMP Snooping with Proxy Reporting. (Default: Based on global setting)

When proxy reporting is enabled with this command, the switch performs “IGMP Snooping with Proxy Reporting” (as defined in DSL Forum TR-101, April 2006), including last leave, and query suppression.

Last leave sends out a proxy query when the last member leaves a multicast group, and query suppression means that specific queries are not forwarded from an upstream multicast router to hosts downstream from this device.

Rules Used for Proxy Reporting

When IGMP Proxy Reporting is disabled, the switch will use a null IP address for the source of IGMP query and report messages unless a proxy query address has been set.

When IGMP Proxy Reporting is enabled, the source address is based on the following criteria:

- If a proxy query address is configured, the switch will use that address as the source IP address in general and group-specific query messages sent to downstream hosts, and in report and leave messages sent upstream from the multicast router port.
- If a proxy query address is not configured, the switch will use the VLAN's IP address as the IP source address in general and group-specific query messages sent downstream, and use the source address of the last IGMP message received from a downstream host in report and leave messages sent upstream from the multicast router port.

- ◆ **Interface Version** – Sets the protocol version for compatibility with other devices on the network. This is the IGMP Version the switch uses to send snooping reports. (Range: 1-3; Default: 2)

This attribute configures the IGMP report/query version used by IGMP snooping. Versions 1 - 3 are all supported, and versions 2 and 3 are backward compatible, so the switch can operate with other devices, regardless of the snooping version employed.

- ◆ **Query Interval** – The interval between sending IGMP general queries. (Range: 2-31744 seconds; Default: 125 seconds)

An IGMP general query message is sent by the switch at the interval specified by this attribute. When this message is received by downstream hosts, all receivers build an IGMP report for the multicast groups they have joined.

This command applies when the switch is serving as the querier ([page 570](#)), or as a proxy host when IGMP snooping proxy reporting is enabled ([page 570](#)).

- ◆ **Query Response Interval** – The maximum time the system waits for a response to general queries. (Range: 10-31740 tenths of a second in multiples of 10; Default: 10 seconds)

This command applies when the switch is serving as the querier (page 570), or as a proxy host when IGMP snooping proxy reporting is enabled (page 570).

- ◆ **Last Member Query Interval** – The interval to wait for a response to a group-specific query message. (Range: 1-31744 tenths of a second in multiples of 10; Default: 1 second)

When a multicast host leaves a group, it sends an IGMP leave message. When the leave message is received by the switch, it checks to see if this host is the last to leave the group by sending out an IGMP group-specific or group-and-source-specific query message, and starts a timer. If no reports are received before the timer expires, the group record is deleted, and a report is sent to the upstream multicast router.

A reduced value will result in reduced time to detect the loss of the last member of a group or source, but may generate more burst traffic.

This attribute will take effect only if IGMP snooping proxy reporting is enabled (page 570) or IGMP querier is enabled (page 570).

- ◆ **Last Member Query Count** – The number of IGMP proxy group-specific or group-and-source-specific query messages that are sent out before the system assumes there are no more local members. (Range: 1-255; Default: 2)

This attribute will take effect only if IGMP snooping proxy reporting or IGMP querier is enabled.

- ◆ **Proxy Query Address** – A static source address for locally generated query and report messages used by IGMP Proxy Reporting. (Range: Any valid IP unicast address; Default: 0.0.0.0)

IGMP Snooping uses a null IP address of 0.0.0.0 for the source of IGMP query messages which are proxied to downstream hosts to indicate that it is not the elected querier, but is only proxying these messages as defined in RFC 4541. The switch also uses a null address in IGMP reports sent to upstream ports.

Many hosts do not implement RFC 4541, and therefore do not understand query messages with the source address of 0.0.0.0. These hosts will therefore not reply to the queries, causing the multicast router to stop sending traffic to them.

To resolve this problem, the source address in proxied IGMP query messages can be replaced with any valid unicast address (other than the router's own address).

WEB INTERFACE

To configure IGMP snooping on a VLAN:

1. Click Multicast, IGMP Snooping, Interface.
2. Select Configure VLAN from the Action list.

3. Select the VLAN to configure and update the required parameters.
4. Click Apply.

Figure 332: Configuring IGMP Snooping on a VLAN

To show the interface settings for IGMP snooping:

1. Click Multicast, IGMP Snooping, Interface.
2. Select Show VLAN Information from the Action list.

Figure 333: Showing Interface Settings for IGMP Snooping

VLAN	IGMP Snooping Status	Immediate Leave Status	Query Interval	Query Response Interval	Last Member Query Interval	Last Member Query Count	Proxy (Query) Address	Proxy Reporting	Multicast Router Discovery	General Query Suppression	Version Exclusive	Interface Version
1	Enabled	Disabled	10	100	10	2	10.1.1.1	Enabled	Enabled	Disabled	Enabled	1
2	Disabled	Disabled	10	100	10	2	20.2.2.2	Disabled	Disabled	Enabled	Disabled	3
3	Disabled	Disabled	10	100	10	2	30.3.3.3	Disabled	Enabled	Disabled	Disabled	2
10	Disabled	Disabled	10	100	10	2	100.10.10.10	Disabled	Disabled	Enabled	Disabled	1

FILTERING IGMP QUERY PACKETS AND MULTICAST DATA

Use the Multicast > IGMP Snooping > Interface (Configure Interface) page to configure an interface to drop IGMP query packets or multicast data packets.

CLI REFERENCES

- ◆ "ip igmp query-drop" on page 1257
- ◆ "ip multicast-data-drop" on page 1257

PARAMETERS

These parameters are displayed:

- ◆ **Interface** – Specifies port or trunk selection.
- ◆ **IGMP Query Drop** – Configures an interface to drop any IGMP query packets received on the specified interface. If this switch is acting as a Querier, this prevents it from being affected by messages received from another Querier. (Default: Disabled)
- ◆ **Multicast Data Drop** – Configures an interface to stop multicast services from being forwarded to users attached to the downstream port; i.e., the interfaces specified by this command. (Default: Disabled)

WEB INTERFACE

To drop IGMP query packets or multicast data packets:

1. Click Multicast, IGMP Snooping, Interface.
2. Select Configure Port or Configure Trunk from the Action List.
3. Enable the required drop functions for any interface.
4. Click Apply.

Figure 334: Dropping IGMP Query or Multicast Data Packets

Port	IGMP Query Drop	Multicast Data Drop
1	<input type="checkbox"/> Enabled	<input type="checkbox"/> Enabled
2	<input type="checkbox"/> Enabled	<input type="checkbox"/> Enabled
3	<input type="checkbox"/> Enabled	<input type="checkbox"/> Enabled
4	<input type="checkbox"/> Enabled	<input type="checkbox"/> Enabled
5	<input type="checkbox"/> Enabled	<input type="checkbox"/> Enabled

**DISPLAYING
MULTICAST GROUPS
DISCOVERED BY
IGMP SNOOPING**

Use the Multicast > IGMP Snooping > Forwarding Entry page to display the forwarding entries learned through IGMP Snooping.

CLI REFERENCES

- ◆ "show ip igmp snooping group" on page 1244
- ◆ "clear ip igmp snooping groups dynamic" on page 1242

COMMAND USAGE

To display information about multicast groups, IGMP Snooping must first be enabled on the switch (see [page 570](#)).

PARAMETERS

These parameters are displayed:

- ◆ **VLAN** – An interface on the switch that is forwarding traffic to downstream ports for the specified multicast group address.
- ◆ **Group Address** – IP multicast group address with subscribers directly attached or downstream from the switch, or a static multicast group assigned to this interface.
- ◆ **Interface** – A downstream port or trunk that is receiving traffic for the specified multicast group. This field may include both dynamically and statically configured multicast router ports.
- ◆ **Up Time** – Time that this multicast group has been known.
- ◆ **Expire** – Time until this entry expires.
- ◆ **Count** – The number of times this address has been learned by IGMP snooping.

WEB INTERFACE

To show multicast groups learned through IGMP snooping:

1. Click Multicast, IGMP Snooping, Forwarding Entry.
2. Select the VLAN for which to display this information.

Figure 335: Showing Multicast Groups Learned by IGMP Snooping

Multicast > IGMP Snooping > Forwarding Entry

VLAN: 1

IGMP Snooping Forwarding Entry List Total: 10

Group Address	Interface	Up Time	Expire	Count
224.1.1.1	Eth 1 / 9 (Router Port)	00:00:06:46		2 (Port)
	Eth 1 / 11 (Member Port)			
224.1.1.2	Eth 1 / 9 (Router Port)	00:00:06:46	03:46	1 (Host)
	Eth 1 / 11 (Member Port)		02:24	1 (Port)
224.1.1.3	Eth 1 / 9 (Router Port)	00:00:16:14		1 (Port)
	Eth 1 / 9 (Router Port)			
239.255.255.250	Eth 1 / 9 (Router Port)	00:00:08:47		2 (Port)
	Eth 1 / 11 (Member Port)			

Clear Click this button to clear all IGMP Snooping dynamic groups.

DISPLAYING IGMP SNOOPING STATISTICS

Use the Multicast > IGMP Snooping > Statistics pages to display IGMP snooping protocol-related statistics for the specified interface.

CLI REFERENCES

- ◆ ["show ip igmp snooping statistics" on page 1246](#)
- ◆ ["clear ip igmp snooping statistics" on page 1243](#)

PARAMETERS

These parameters are displayed:

- ◆ **VLAN** – VLAN identifier. (Range: 1-4094)
- ◆ **Port** – Port identifier. (Range: 1-28/52)
- ◆ **Trunk** – Trunk identifier. (Range: 1-16)

Query Statistics

- ◆ **Other Querier** – IP address of remote querier on this interface.
- ◆ **Other Querier Expire** – Time after which remote querier is assumed to have expired.
- ◆ **Other Querier Uptime** – Time remote querier has been up.
- ◆ **Self Querier** – IP address of local querier on this interface.
- ◆ **Self Querier Expire** – Time after which local querier is assumed to have expired.
- ◆ **Self Querier Uptime** – Time local querier has been up.
- ◆ **General Query Received** – The number of general queries received on this interface.

- ◆ **General Query Sent** – The number of general queries sent from this interface.
- ◆ **Specific Query Received** – The number of specific queries received on this interface.
- ◆ **Specific Query Sent** – The number of specific queries sent from this interface.
- ◆ **Warn Rate Limit** – The rate at which received query messages of the wrong version type cause the Vx warning count to increment. Note that “0 sec” means that the Vx warning count is incremented for each wrong message version received.
- ◆ **V1 Warning Count** – The number of times the query version received (Version 1) does not match the version configured for this interface.
- ◆ **V2 Warning Count** – The number of times the query version received (Version 2) does not match the version configured for this interface.
- ◆ **V3 Warning Count** – The number of times the query version received (Version 3) does not match the version configured for this interface.

VLAN, Port, and Trunk Statistics

Input Statistics

- ◆ **Report** – The number of IGMP membership reports received on this interface.
- ◆ **Leave** – The number of leave messages received on this interface.
- ◆ **G Query** – The number of general query messages received on this interface.
- ◆ **G(-S)-S Query** – The number of group specific or group-and-source specific query messages received on this interface.
- ◆ **Drop** – The number of times a report, leave or query was dropped. Packets may be dropped due to invalid format, rate limiting, packet content not allowed, or IGMP group report received.
- ◆ **Join Success** – The number of times a multicast group was successfully joined.
- ◆ **Group** – The number of IGMP groups active on this interface.

Output Statistics

- ◆ **Report** – The number of IGMP membership reports sent from this interface.
- ◆ **Leave** – The number of leave messages sent from this interface.

- ◆ **G Query** – The number of general query messages sent from this interface.
- ◆ **G(-S)-S Query** – The number of group specific or group-and-source specific query messages sent from this interface.
- ◆ **Drop** – The number of times a report, leave or query was dropped. Packets may be dropped due to invalid format, rate limiting, packet content not allowed, or IGMP group report received.
- ◆ **Group** – The number of IGMP groups active on this interface.

WEB INTERFACE

To display statistics for IGMP snooping query-related messages:

1. Click Multicast, IGMP Snooping, Statistics.
2. Select Show Query Statistics from the Action list.
3. Select a VLAN.

Figure 336: Displaying IGMP Snooping Statistics – Query

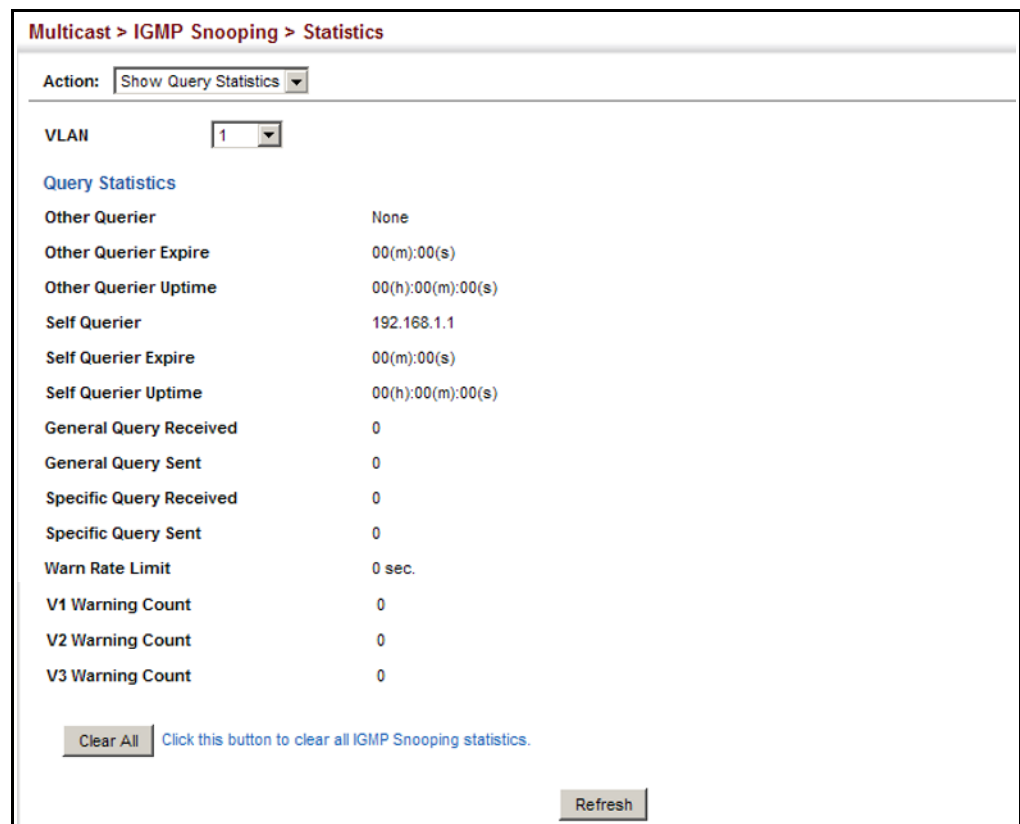

To display IGMP snooping protocol-related statistics for a VLAN:

1. Click Multicast, IGMP Snooping, Statistics.
2. Select Show VLAN Statistics from the Action list.

3. Select a VLAN.

Figure 337: Displaying IGMP Snooping Statistics – VLAN

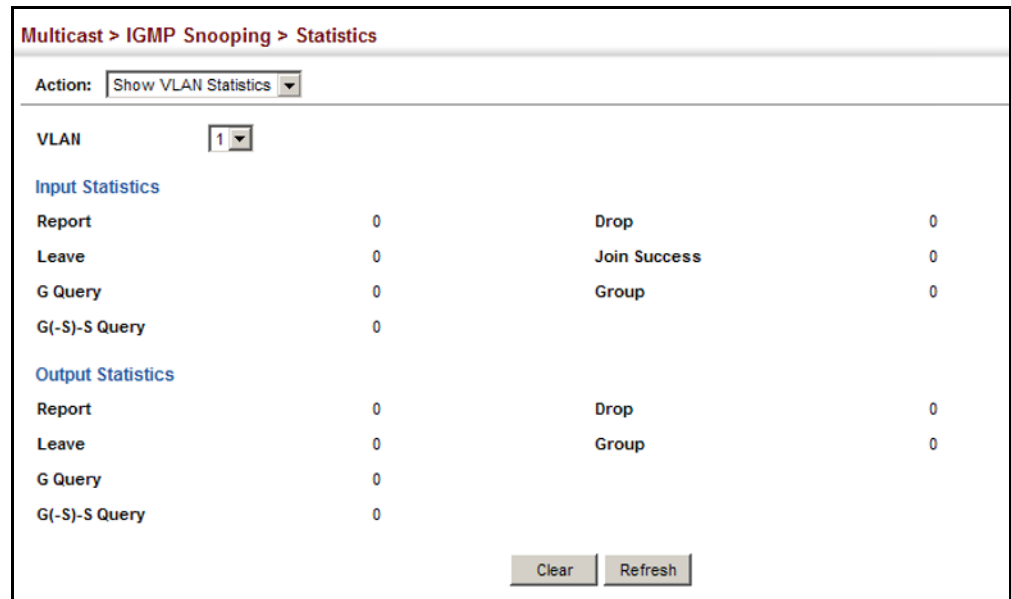

To display IGMP snooping protocol-related statistics for a port:

1. Click Multicast, IGMP Snooping, Statistics.
2. Select Show Port Statistics from the Action list.
3. Select a Port.

Figure 338: Displaying IGMP Snooping Statistics – Port

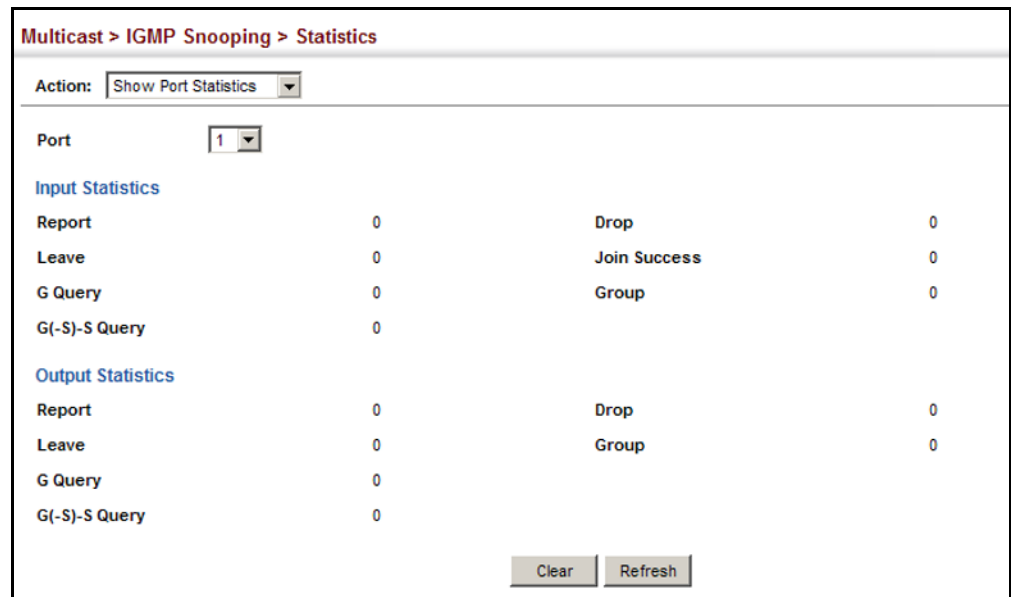

FILTERING AND THROTTLING IGMP GROUPS

In certain switch applications, the administrator may want to control the multicast services that are available to end users. For example, an IP/TV service based on a specific subscription plan. The IGMP filtering feature fulfills this requirement by restricting access to specified multicast services on a switch port, and IGMP throttling limits the number of simultaneous multicast groups a port can join.

IGMP filtering enables you to assign a profile to a switch port that specifies multicast groups that are permitted or denied on the port. An IGMP filter profile can contain one or more addresses, or a range of multicast addresses; but only one profile can be assigned to a port. When enabled, IGMP join reports received on the port are checked against the filter profile. If a requested multicast group is permitted, the IGMP join report is forwarded as normal. If a requested multicast group is denied, the IGMP join report is dropped.

IGMP throttling sets a maximum number of multicast groups that a port can join at the same time. When the maximum number of groups is reached on a port, the switch can take one of two actions; either “deny” or “replace.” If the action is set to deny, any new IGMP join reports will be dropped. If the action is set to replace, the switch randomly removes an existing group and replaces it with the new multicast group.

ENABLING IGMP FILTERING AND THROTTLING

Use the Multicast > IGMP Snooping > Filter (Configure General) page to enable IGMP filtering and throttling globally on the switch.

CLI REFERENCES

- ◆ ["ip igmp filter \(Global Configuration\)" on page 1251](#)

PARAMETERS

These parameters are displayed:

- ◆ **IGMP Filter Status** – Enables IGMP filtering and throttling globally for the switch. (Default: Disabled)

WEB INTERFACE

To enable IGMP filtering and throttling on the switch:

1. Click Multicast, IGMP Snooping, Filter.
2. Select Configure General from the Step list.
3. Enable IGMP Filter Status.
4. Click Apply.

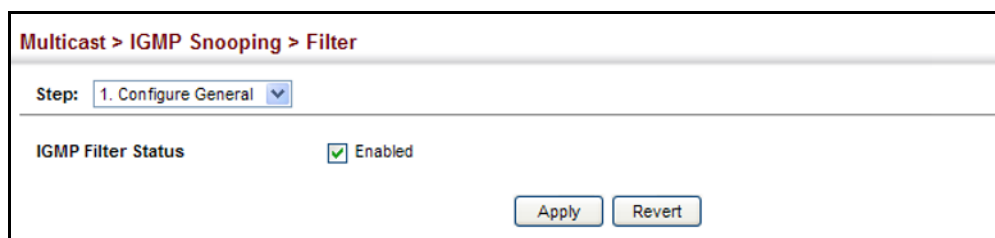
Figure 339: Enabling IGMP Filtering and Throttling

CONFIGURING IGMP FILTER PROFILES

Use the Multicast > IGMP Snooping > Filter (Configure Profile – Add) page to create an IGMP profile and set its access mode. Then use the (Add Multicast Group Range) page to configure the multicast groups to filter.

CLI REFERENCES

- ◆ ["IGMP Filtering and Throttling" on page 1250](#)

COMMAND USAGE

Specify a range of multicast groups by entering a start and end IP address; or specify a single multicast group by entering the same IP address for the start and end of the range.

PARAMETERS

These parameters are displayed:

Add

- ◆ **Profile ID** – Creates an IGMP profile. (Range: 1-4294967295)
- ◆ **Access Mode** – Sets the access mode of the profile; either permit or deny. (Default: Deny)

When the access mode is set to permit, IGMP join reports are processed when a multicast group falls within the controlled range. When the access mode is set to deny, IGMP join reports are only processed when the multicast group is not in the controlled range.

Add Multicast Group Range

- ◆ **Profile ID** – Selects an IGMP profile to configure.
- ◆ **Start Multicast IP Address** – Specifies the starting address of a range of multicast groups.
- ◆ **End Multicast IP Address** – Specifies the ending address of a range of multicast groups.

WEB INTERFACE

To create an IGMP filter profile and set its access mode:

1. Click Multicast, IGMP Snooping, Filter.
2. Select Configure Profile from the Step list.
3. Select Add from the Action list.
4. Enter the number for a profile, and set its access mode.
5. Click Apply.

Figure 340: Creating an IGMP Filtering Profile

Multicast > IGMP Snooping > Filter

Step: 2. Configure Profile Action: Add

Profile ID (1-4294967295) 19

Access Mode Permit

Apply Revert

To show the IGMP filter profiles:

1. Click Multicast, IGMP Snooping, Filter.
2. Select Configure Profile from the Step list.
3. Select Show from the Action list.

Figure 341: Showing the IGMP Filtering Profiles Created

Multicast > IGMP Snooping > Filter

Step: 2. Configure Profile Action: Show

IGMP Snooping Filter Profile List Total: 1

<input type="checkbox"/>	Profile ID	Action Mode
<input checked="" type="checkbox"/>	19	Permit

Delete Revert

To add a range of multicast groups to an IGMP filter profile:

1. Click Multicast, IGMP Snooping, Filter.
2. Select Configure Profile from the Step list.
3. Select Add Multicast Group Range from the Action list.
4. Select the profile to configure, and add a multicast group address or range of addresses.

5. Click Apply.

Figure 342: Adding Multicast Groups to an IGMP Filtering Profile

Multicast > IGMP Snooping > Filter

Step: 2. Configure Profile Action: Add Multicast Group Range

Profile ID: 19

Start Multicast IP Address: 239.2.3.1

End Multicast IP Address: 239.2.3.200

Apply Revert

To show the multicast groups configured for an IGMP filter profile:

1. Click Multicast, IGMP Snooping, Filter.
2. Select Configure Profile from the Step list.
3. Select Show Multicast Group Range from the Action list.
4. Select the profile for which to display this information.

Figure 343: Showing the Groups Assigned to an IGMP Filtering Profile

Multicast > IGMP Snooping > Filter

Step: 2. Configure Profile Action: Show Multicast Group Range

Profile ID: 19

Multicast IP Address Range List Total: 1

	Start Multicast IP Address	End Multicast IP Address
<input type="checkbox"/>	239.2.3.1	239.2.3.200

Delete Revert

CONFIGURING IGMP FILTERING AND THROTTLING FOR INTERFACES

Use the Multicast > IGMP Snooping > Filter (Configure Interface) page to assign and IGMP filter profile to interfaces on the switch, or to throttle multicast traffic by limiting the maximum number of multicast groups an interface can join at the same time.

CLI REFERENCES

- ◆ ["IGMP Filtering and Throttling" on page 1250](#)

COMMAND USAGE

- ◆ IGMP throttling sets a maximum number of multicast groups that a port can join at the same time. When the maximum number of groups is reached on a port, the switch can take one of two actions; either "deny" or "replace." If the action is set to deny, any new IGMP join reports will be dropped. If the action is set to replace, the switch randomly

removes an existing group and replaces it with the new multicast group.

PARAMETERS

These parameters are displayed:

- ◆ **Interface** – Port or trunk identifier.
An IGMP profile or throttling setting can be applied to a port or trunk. When ports are configured as trunk members, the trunk uses the settings applied to the first port member in the trunk.
- ◆ **Profile ID** – Selects an existing profile to assign to an interface.
- ◆ **Max Multicast Groups** – Sets the maximum number of multicast groups an interface can join at the same time. (Range: 1-1023; Default: 1023)
- ◆ **Current Multicast Groups** – Displays the current multicast groups the interface has joined.
- ◆ **Throttling Action Mode** – Sets the action to take when the maximum number of multicast groups for the interface has been exceeded. (Default: Deny)
 - **Deny** - The new multicast group join report is dropped.
 - **Replace** - The new multicast group replaces an existing group.
- ◆ **Throttling Status** – Indicates if the throttling action has been implemented on the interface. (Options: True or False)

WEB INTERFACE

To configure IGMP filtering or throttling for a port or trunk:

1. Click Multicast, IGMP Snooping, Filter.
2. Select Configure Interface from the Step list.
3. Select a profile to assign to an interface, then set the maximum number of allowed multicast groups and the throttling response.
4. Click Apply.

Figure 344: Configuring IGMP Filtering and Throttling Interface Settings

Port	Profile ID	Max Multicast Groups (1-1024)	Current Multicast Groups	Throttling Action Mode	Throttling Status
1	19	64	0	Deny	False
2	(none)	1024	0	Deny	False
3	(none)	1024	0	Deny	False
4	(none)	1024	0	Deny	False
5	(none)	1024	0	Deny	False

MLD SNOOPING (SNOOPING AND QUERY FOR IPV6)

Multicast Listener Discovery (MLD) snooping operates on IPv6 traffic and performs a similar function to IGMP snooping for IPv4. That is, MLD snooping dynamically configures switch ports to limit IPv6 multicast traffic so that it is forwarded only to ports with users that want to receive it. This reduces the flooding of IPv6 multicast packets in the specified VLANs.

There are two versions of the MLD protocol, version 1 and version 2. MLDv1 control packets include Listener Query, Listener Report, and Listener Done messages (equivalent to IGMPv2 query, report, and leave messages). MLDv2 control packets include MLDv2 query and report messages, as well as MLDv1 report and done messages.

Remember that IGMP Snooping and MLD Snooping are independent functions, and can therefore both function at the same time.



NOTE: Due to an ASIC limitation in the ECS4110-52T, MLDv2 reports with source list is not supported. The switch can only process IS_EX (is excluded), TO_EX (change to excluded), and TO_IN (change to included) records without source list.

CONFIGURING MLD SNOOPING AND QUERY PARAMETERS

Use the Multicast > MLD Snooping > General page to configure the switch to forward multicast traffic intelligently. Based on the MLD query and report messages, the switch forwards multicast traffic only to the ports that request it. This prevents the switch from broadcasting the traffic to all ports and possibly disrupting network performance.

CLI REFERENCES

- ◆ "MLD Snooping" on page 1262

PARAMETERS

These parameters are displayed:

- ◆ **MLD Snooping Status** – When enabled, the switch will monitor network traffic to determine which hosts want to receive multicast traffic. (Default: Disabled)
- ◆ **Querier Status** – When enabled, the switch can serve as the querier for MLDv2 snooping if elected. The querier is responsible for asking hosts if they want to receive multicast traffic. (Default: Disabled)

An IPv6 address must be configured on the VLAN interface from which the querier will act if elected. When serving as the querier, the switch uses this IPv6 address as the query source address.

The querier will not start or will disable itself after having started if it detects an IPv6 multicast router on the network.
- ◆ **Robustness** – MLD Snooping robustness variable. A port will be removed from the receiver list for a multicast service when no MLD reports are detected in response to a number of MLD queries. The robustness variable sets the number of queries on ports for which there is no report. (Range: 2-10 Default: 2)
- ◆ **Query Interval** – The interval between sending MLD general queries. (Range: 60-125 seconds; Default: 125 seconds)

This attribute applies when the switch is serving as the querier.

An MLD general query message is sent by the switch at the interval specified by this attribute. When this message is received by downstream hosts, all receivers build an MLD report for the multicast groups they have joined.
- ◆ **Query Max Response Time** – The maximum response time advertised in MLD general queries. (Range: 5-25 seconds; Default: 10 seconds)

This attribute controls how long the host has to respond to an MLD Query message before the switch deletes the group if it is the last member.
- ◆ **Router Port Expiry Time** – The time the switch waits after the previous querier stops before it considers the router port (i.e., the interface that had been receiving query packets) to have expired. (Range: 300-500 seconds; Default: 300 seconds)
- ◆ **MLD Snooping Version** – The protocol version used for compatibility with other devices on the network. This is the MLD version the switch uses to send snooping reports. (Range: 1-2; Default: 2)
- ◆ **Unknown Multicast Mode** – The action for dealing with unknown multicast packets. Options include:
 - **Flood** – Floods any received IPv6 multicast packets that have not been requested by a host to all ports in the VLAN.

- **To Router Port** – Forwards any received IPv6 multicast packets that have not been requested by a host to ports that are connected to a detected multicast router. (This is the default action.)

WEB INTERFACE

To configure general settings for MLD Snooping:

1. Click Multicast, MLD Snooping, General.
2. Adjust the settings as required.
3. Click Apply.

Figure 345: Configuring General Settings for MLD Snooping

SETTING IMMEDIATE LEAVE STATUS FOR MLD SNOOPING PER INTERFACE

Use the Multicast > MLD Snooping > Interface page to configure Immediate Leave status for a VLAN.

CLI REFERENCES

- ◆ ["ipv6 mld snooping vlan immediate-leave" on page 1267](#)

PARAMETERS

These parameters are displayed:

- ◆ **VLAN** – A VLAN identification number. (Range: 1-4094)
- ◆ **Immediate Leave Status** – Immediately deletes a member port of an IPv6 multicast service when a leave packet is received at that port and immediate leave is enabled for the parent VLAN. (Default: Disabled)

If MLD immediate-leave is *not* used, a multicast router (or querier) will send a group-specific query message when an MLD group leave message is received. The router/querier stops forwarding traffic for that group only if no host replies to the query within the specified timeout period.

If MLD immediate-leave is enabled, the switch assumes that only one host is connected to the interface. Therefore, immediate leave should only be enabled on an interface if it is connected to only one MLD-

enabled device, either a service host or a neighbor running MLD snooping.

WEB INTERFACE

To configure immediate leave for MLD Snooping:

1. Click Multicast, MLD Snooping, Interface.
2. Select a VLAN, and set the status for immediate leave.
3. Click Apply.

Figure 346: Configuring Immediate Leave for MLD Snooping

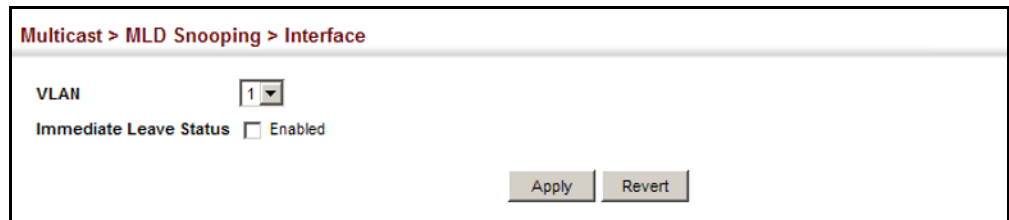

SPECIFYING STATIC INTERFACES FOR AN IPV6 MULTICAST ROUTER

Use the Multicast > MLD Snooping > Multicast Router (Add Static Multicast Router) page to statically attach an interface to an IPv6 multicast router/switch.

Depending on your network connections, MLD snooping may not always be able to locate the MLD querier. Therefore, if the MLD querier is a known multicast router/switch connected over the network to an interface (port or trunk) on the switch, you can manually configure that interface to join all the current multicast groups.

CLI REFERENCES

- ◆ ["ipv6 mld snooping vlan mrouter" on page 1268](#)

COMMAND USAGE

MLD Snooping must be enabled globally on the switch (see ["Configuring MLD Snooping and Query Parameters" on page 595](#)) before a multicast router port can take effect.

PARAMETERS

These parameters are displayed:

- ◆ **VLAN** – Selects the VLAN which is to propagate all IPv6 multicast traffic coming from the attached multicast router. (Range: 1-4094)
- ◆ **Interface** – Activates the Port or Trunk scroll down list.
- ◆ **Port or Trunk** – Specifies the interface attached to a multicast router.

WEB INTERFACE

To specify a static interface attached to a multicast router:

1. Click Multicast, MLD Snooping, Multicast Router.
2. Select Add Static Multicast Router from the Action list.
3. Select the VLAN which will forward all the corresponding IPv6 multicast traffic, and select the port or trunk attached to the multicast router.
4. Click Apply.

Figure 347: Configuring a Static Interface for an IPv6 Multicast Router

To show the static interfaces attached to a multicast router:

1. Click Multicast, MLD Snooping, Multicast Router.
2. Select Show Static Multicast Router from the Action list.
3. Select the VLAN for which to display this information.

Figure 348: Showing Static Interfaces Attached an IPv6 Multicast Router

	Interface
<input type="checkbox"/>	Unit 1 / Port 1
<input type="checkbox"/>	Unit 1 / Port 2

To show all the interfaces attached to a multicast router:

1. Click Multicast, MLD Snooping, Multicast Router.
2. Select Current Multicast Router from the Action list.
3. Select the VLAN for which to display this information. Ports in the selected VLAN which are attached to a neighboring multicast router/ switch are displayed.

Figure 349: Showing Current Interfaces Attached an IPv6 Multicast Router

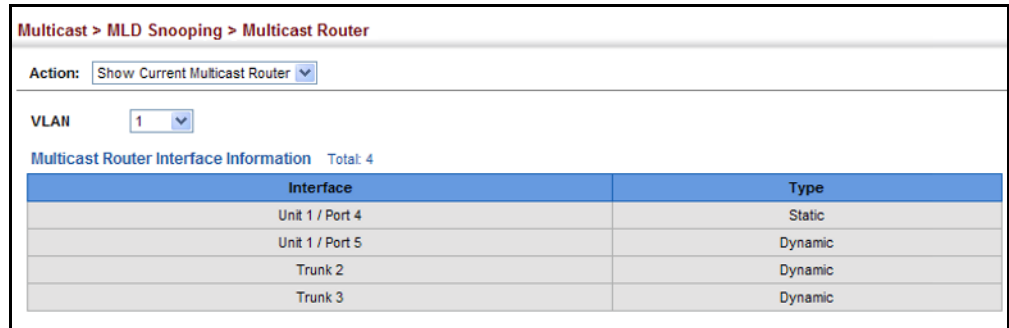

Multicast > MLD Snooping > Multicast Router

Action: Show Current Multicast Router

VLAN: 1

Multicast Router Interface Information Total: 4

Interface	Type
Unit 1 / Port 4	Static
Unit 1 / Port 5	Dynamic
Trunk 2	Dynamic
Trunk 3	Dynamic

ASSIGNING INTERFACES TO IPv6 MULTICAST SERVICES

Use the Multicast > MLD Snooping > MLD Member (Add Static Member) page to statically assign an IPv6 multicast service to an interface.

Multicast filtering can be dynamically configured using MLD snooping and query messages (see "[Configuring MLD Snooping and Query Parameters](#)" on page 595). However, for certain applications that require tighter control, it may be necessary to statically configure a multicast service on the switch. First add all the ports attached to participating hosts to a common VLAN, and then assign the multicast service to that VLAN group.

CLI REFERENCES

- ◆ "[ipv6 mld snooping vlan static](#)" on page 1269
- ◆ "[clear ipv6 mld snooping groups dynamic](#)" on page 1269

COMMAND USAGE

- ◆ Static multicast addresses are never aged out.
- ◆ When a multicast address is assigned to an interface in a specific VLAN, the corresponding traffic can only be forwarded to ports within that VLAN.

PARAMETERS

These parameters are displayed:

- ◆ **VLAN** – Specifies the VLAN which is to propagate the multicast service. (Range: 1-4094)
- ◆ **Multicast IPv6 Address** – The IP address for a specific multicast service.
- ◆ **Interface** – Activates the Port or Trunk scroll down list.
- ◆ **Port** or **Trunk** – Specifies the interface assigned to a multicast group.
- ◆ **Type** (Show Current Member) – Shows if this multicast stream was statically configured by the user, discovered by MLD Snooping, or is a data stream to which no other ports are subscribing (i.e., the stream is flooded onto VLAN instead of being trapped to the CPU for processing, or is being processed by MVR6).

WEB INTERFACE

To statically assign an interface to an IPv6 multicast service:

1. Click Multicast, MLD Snooping, MLD Member.
2. Select Add Static Member from the Action list.
3. Select the VLAN that will propagate the multicast service, specify the interface attached to a multicast service (through an MLD-enabled switch or multicast router), and enter the multicast IP address.
4. Click Apply.

Figure 350: Assigning an Interface to an IPv6 Multicast Service

To show the static interfaces assigned to an IPv6 multicast service:

1. Click Multicast, MLD Snooping, MLD Member.
2. Select Show Static Member from the Action list.
3. Select the VLAN for which to display this information.

Figure 351: Showing Static Interfaces Assigned to an IPv6 Multicast Service

<input type="checkbox"/>	Multicast IPv6 Address	Interface
<input type="checkbox"/>	FF02::01:01:01:01	Unit 1 / Port 1
<input type="checkbox"/>	FF02::01:01:01:02	Unit 1 / Port 2
<input type="checkbox"/>	FF01::1	Unit 1 / Port 12
<input type="checkbox"/>	FF01::2	Unit 1 / Port 13
<input type="checkbox"/>	FF01::3	Unit 1 / Port 14
<input type="checkbox"/>	FF01::4	Unit 1 / Port 15
<input type="checkbox"/>	FF01::5	Unit 1 / Port 16
<input type="checkbox"/>	FF02::01:01:01:FF	Trunk 3

To display information about all IPv6 multicast groups, MLD Snooping or multicast routing must first be enabled on the switch. To show all of the interfaces statically or dynamically assigned to an IPv6 multicast service:

1. Click Multicast, MLD Snooping, MLD Member.
2. Select Show Current Member from the Action list.
3. Select the VLAN for which to display this information.

Figure 352: Showing Current Interfaces Assigned to an IPv6 Multicast Service

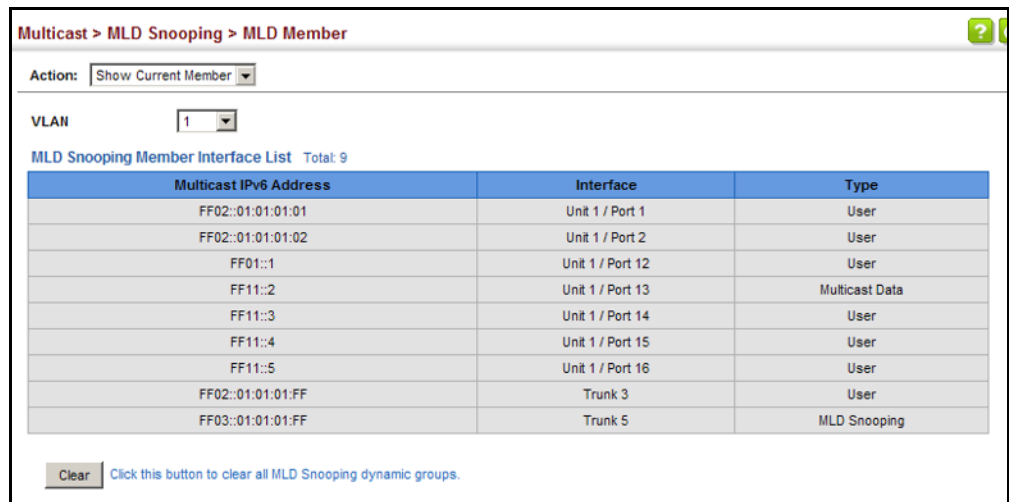

SHOWING MLD SNOOPING GROUPS AND SOURCE LIST

Use the Multicast > MLD Snooping > Group Information page to display known multicast groups, member ports, the means by which each group was learned, and the corresponding source list.

CLI REFERENCES

- ◆ ["show ipv6 mld snooping group source-list" on page 1271](#)

PARAMETERS

These parameters are displayed:

- ◆ **VLAN** – VLAN identifier. (Range: 1-4094)
- ◆ **Interface** – Port or trunk identifier.
- ◆ **Group Address** – The IP address for a specific multicast service.
- ◆ **Type** – The means by which each group was learned – MLD Snooping or Multicast Data.
- ◆ **Filter Mode** – The filter mode is used to summarize the total listening state of a multicast address to a minimum set such that all nodes' listening states are respected. In Include mode, the router only uses the request list, indicating that the reception of packets sent to the specified multicast address. In Exclude mode, the router uses both the

request list and exclude list, indicating that the reception of packets sent to the given multicast address is requested from all IP source addresses, except for those listed in the exclude source-list and for any other sources where the source timer status has expired.

- ◆ **Filter Timer Elapse** – The Filter timer is only used when a specific multicast address is in Exclude mode. It represents the time for the multicast address filter mode to expire and change to Include mode.
- ◆ **Request List** – Sources included on the router’s request list.
- ◆ **Exclude List** – Sources included on the router’s exclude list.

WEB INTERFACE

To display known MLD multicast groups:

1. Click Multicast, MLD Snooping, Group Information.
2. Select the port or trunk, and then select a multicast service assigned to that interface.

Figure 353: Showing IPv6 Multicast Services and Corresponding Sources

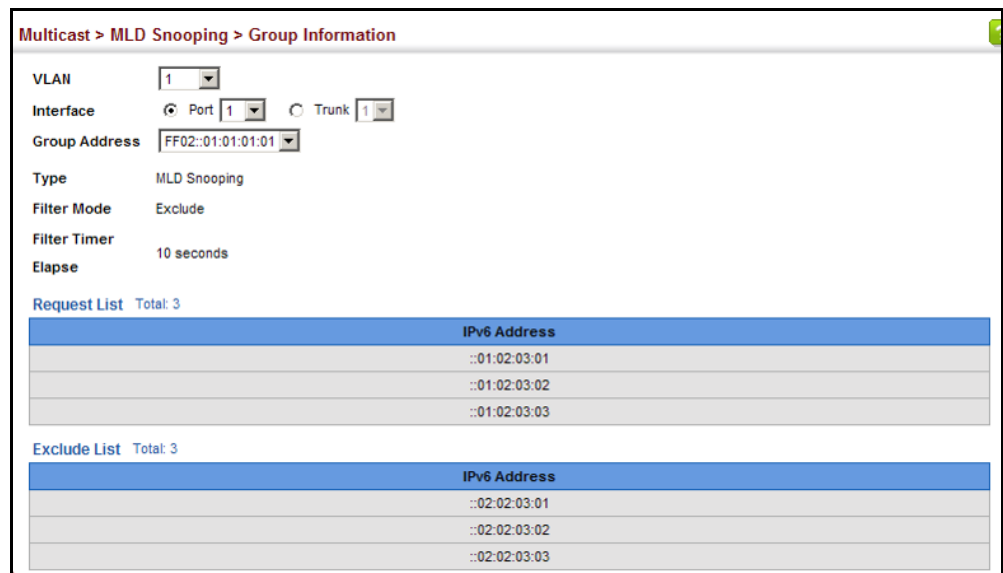

MULTICAST VLAN REGISTRATION FOR IPv4

Multicast VLAN Registration (MVR) is a protocol that controls access to a single network-wide VLAN most commonly used for transmitting multicast traffic (such as television channels or video-on-demand) across a service provider’s network. Any multicast traffic entering an MVR VLAN is sent to all attached subscribers. This protocol can significantly reduce to processing overhead required to dynamically monitor and establish the distribution tree for a normal multicast VLAN. This makes it possible to

support common multicast services over a wide part of the network without having to use any multicast routing protocol.

MVR maintains the user isolation and data security provided by VLAN segregation by passing only multicast traffic into other VLANs to which the subscribers belong. Even though common multicast streams are passed onto different VLAN groups from the MVR VLAN, users in different IEEE 802.1Q or private VLANs cannot exchange any information (except through upper-level routing services).

Figure 354: MVR Concept

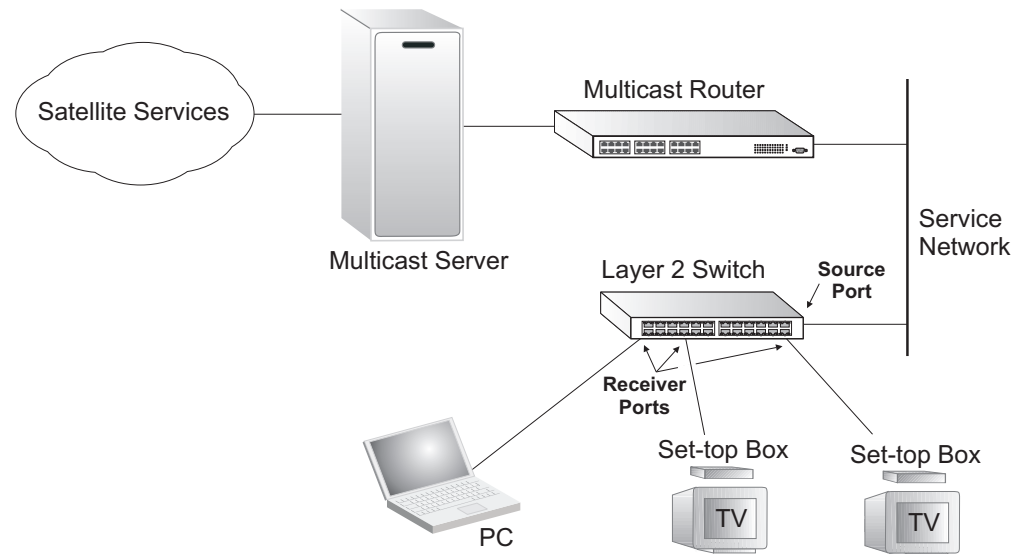

COMMAND USAGE

◆ General Configuration Guidelines for MVR:

1. Enable MVR for a domain on the switch, and select the MVR VLAN (see ["Configuring MVR Domain Settings" on page 607](#)).
 2. Create an MVR profile by specifying the multicast groups that will stream traffic to attached hosts, and assign the profile to an MVR domain (see ["Configuring MVR Group Address Profiles" on page 608](#)).
 3. Set the interfaces that will join the MVR as source ports or receiver ports (see ["Configuring MVR Interface Status" on page 611](#)).
 4. For multicast streams that will run for a long term and be associated with a stable set of hosts, you can statically bind the multicast group to the participating interfaces (see ["Assigning Static MVR Multicast Groups to Interfaces" on page 614](#)).
- ◆ Although MVR operates on the underlying mechanism of IGMP snooping, the two features operate independently of each other. One can be enabled or disabled without affecting the behavior of the other. However, if IGMP snooping and MVR are both enabled, MVR reacts only to join and leave messages from multicast groups configured under MVR. Join and leave messages from all other multicast groups are managed by IGMP snooping. Also, note that only IGMP version 2 or 3

hosts can issue multicast join or leave messages. Since IGMP version 1 hosts do not support leave messages, they are timed out by the switch.

CONFIGURING MVR GLOBAL SETTINGS Use the Multicast > MVR (Configure Global) page to configure proxy switching and the robustness variable.

CLI REFERENCES

- ◆ "MVR for IPv4" on page 1281

PARAMETERS

These parameters are displayed:

- ◆ **Proxy Switching** – Configures MVR proxy switching, where the source port acts as a host, and the receiver port acts as an MVR router with querier service enabled. (Default: Enabled)
 - When MVR proxy-switching is enabled, an MVR source port serves as the upstream or host interface, and the MVR receiver port serves as the querier. The source port performs only the host portion of MVR by sending summarized membership reports, and automatically disables MVR router functions.
 - Receiver ports are known as downstream or router interfaces. These interfaces perform the standard MVR router functions by maintaining a database of all MVR subscriptions on the downstream interface. Receiver ports must therefore be configured on all downstream interfaces which require MVR proxy service.
 - When the source port receives report and leave messages, it only forwards them to other source ports.
 - When receiver ports receive any query messages, they are dropped.
 - When changes occurring in the downstream MVR groups are learned by the receiver ports through report and leave messages, an MVR state change report is created and sent to the upstream source port, which in turn forwards this information upstream.
 - When MVR proxy switching is disabled:
 - Any membership reports received from receiver/source ports are forwarded to all source ports.
 - When a source port receives a query message, it will be forwarded to all downstream receiver ports.
 - When a receiver port receives a query message, it will be dropped.
- ◆ **Robustness Value** – Configures the expected packet loss, and thereby the number of times to generate report and group-specific queries. (Range: 1-255; Default: 2)

- This parameter is used to set the number of times report messages are sent upstream when changes are learned about downstream groups, and the number of times group-specific queries are sent to downstream receiver ports.
- This parameter only takes effect when MVR proxy switching is enabled.
- ◆ **Proxy Query Interval** – Configures the interval at which the receiver port sends out general queries. (Range: 2-31744 seconds; Default: 125 seconds)
 - This parameter sets the general query interval at which active receiver ports send out general queries.
 - This interval is only effective when proxy switching is enabled.
- ◆ **Source Port Mode** – Configures the switch to forward any multicast streams within the parameters set by a profile, or to only forward multicast streams which the source port has dynamically joined.
 - **Always Forward** – By default, the switch forwards any multicast streams within the address range set by a profile, and bound to a domain. The multicast streams are sent to all source ports on the switch and to all receiver ports that have elected to receive data on that multicast address.
 - **Dynamic** – When dynamic mode is enabled, the switch only forwards multicast streams which the source port has dynamically joined. In other words, both the receiver port and source port must subscribe to a multicast group before a multicast stream is forwarded to any attached client. Note that the requested streams are still restricted to the address range which has been specified in a profile and bound to a domain.

WEB INTERFACE

To configure global settings for MVR:

1. Click Multicast, MVR.
2. Select Configure Global from the Step list.
3. Set the status for MVR proxy switching, the robustness value used for report and query messages, the proxy query interval, and source port mode.
4. Click Apply.

Figure 355: Configuring Global Settings for MVR

The screenshot shows the configuration page for Multicast > MVR. The page title is "Multicast > MVR". Below the title, there is a "Step:" dropdown menu set to "1. Configure Global". The main configuration area contains the following settings:

- Proxy Switching:** Enabled
- Robustness Value (1-255):**
- Proxy Query Interval (2-31744):** sec
- Source Port Mode:**

At the bottom right of the configuration area, there are two buttons: "Apply" and "Revert".

**CONFIGURING MVR
DOMAIN SETTINGS**

Use the Multicast > MVR (Configure Domain) page to enable MVR globally on the switch, and select the VLAN that will serve as the sole channel for common multicast streams supported by the service provider.

CLI REFERENCES

- ◆ ["MVR for IPv4" on page 1281](#)

PARAMETERS

These parameters are displayed:

- ◆ **Domain ID** – An independent multicast domain. (Range: 1-5)
- ◆ **MVR Status** – When MVR is enabled on the switch, any multicast data associated with an MVR group is sent from all designated source ports, to all receiver ports that have registered to receive data from that multicast group. (Default: Disabled)
- ◆ **MVR VLAN** – Identifier of the VLAN that serves as the channel for streaming multicast services using MVR. MVR source ports should be configured as members of the MVR VLAN (see ["Adding Static Members to VLANs" on page 205](#)), but MVR receiver ports should not be manually configured as members of this VLAN. (Default: 1)
- ◆ **MVR Running Status** – Indicates whether or not all necessary conditions in the MVR environment are satisfied. Running status is Active as long as MVR is enabled, the specified MVR VLAN exists, and a source port with a valid link has been configured (see ["Configuring MVR Interface Status" on page 611](#)).
- ◆ **MVR Current Learned Groups** – The number of MVR groups currently assigned to this domain.
- ◆ **Forwarding Priority** – The CoS priority assigned to all multicast traffic forwarded into this domain. (Range: 0-7, where 7 is the highest priority)

This parameter can be used to set a high priority for low-latency multicast traffic such as a video-conference, or to set a low priority for normal multicast traffic not sensitive to latency.

- ◆ **Upstream Source IP** – The source IP address assigned to all MVR control packets sent upstream on the specified domain. By default, all MVR reports sent upstream use a null source IP address.

WEB INTERFACE

To configure settings for an MVR domain:

1. Click Multicast, MVR.
2. Select Configure Domain from the Step list.
3. Select a domain from the scroll-down list.
4. Enable MVR for the selected domain, select the MVR VLAN, set the forwarding priority to be assigned to all ingress multicast traffic, and set the source IP address for all control packets sent upstream as required.
5. Click Apply.

Figure 356: Configuring Domain Settings for MVR

The screenshot shows the 'Multicast > MVR' configuration page. At the top, there is a 'Step:' dropdown menu set to '2. Configure Domain'. Below this, several configuration fields are listed:

- Domain ID:** A dropdown menu with '1' selected.
- MVR Status:** A checkbox labeled 'Enabled' which is checked.
- MVR VLAN:** A dropdown menu with '1' selected.
- MVR Running Status:** A text field containing 'Inactive'.
- MVR Current Learned Groups:** A text field containing '0'.
- Forwarding Priority (0-7):** A checkbox followed by an empty text input field.
- Upstream Source IP:** A text input field containing '10.1.1.1'.

At the bottom right of the form, there are two buttons: 'Apply' and 'Revert'.

CONFIGURING MVR GROUP ADDRESS PROFILES

Use the Multicast > MVR (Configure Profile and Associate Profile) pages to assign the multicast group address for required services to one or more MVR domains.

CLI REFERENCES

- ◆ ["MVR for IPv4" on page 1281](#)

COMMAND USAGE

- ◆ Use the Configure Profile page to statically configure all multicast group addresses that will join the MVR VLAN. Any multicast data associated with an MVR group is sent from all source ports to all receiver ports that have registered to receive data from that multicast group.

- ◆ The IP address range from 224.0.0.0 to 239.255.255.255 is used for multicast streams. MVR group addresses cannot fall within the reserved IP multicast address range of 224.0.0.x.
- ◆ IGMP snooping and MVR share a maximum number of 1023 groups. Any multicast streams received in excess of this limitation will be flooded to all ports in the associated domain.

PARAMETERS

These parameters are displayed:

Configure Profile

- ◆ **Profile Name** – The name of a profile containing one or more MVR group addresses. (Range: 1-21 characters)
- ◆ **Start IP Address** – Starting IP address for an MVR multicast group. (Range: 224.0.1.0 - 239.255.255.255)
- ◆ **End IP Address** – Ending IP address for an MVR multicast group. (Range: 224.0.1.0 - 239.255.255.255)

Associate Profile

- ◆ **Domain ID** – An independent multicast domain. (Range: 1-5)
- ◆ **Profile Name** – The name of a profile to be assigned to this domain. (Range: 1-21 characters)

WEB INTERFACE

To configure an MVR group address profile:

1. Click Multicast, MVR.
2. Select Configure Profile from the Step list.
3. Select Add from the Action list.
4. Enter the name of a group profile to be assigned to one or more domains, and specify a multicast group that will stream traffic to participating hosts.
5. Click Apply.

Figure 357: Configuring an MVR Group Address Profile

Multicast > MVR

Step: 2. Configure Profile Action: Add

Profile Name: sales

Start IP Address: 234.5.6.8

End IP Address: 234.5.6.10

Apply Revert

To show the configured MVR group address profiles:

1. Click Multicast, MVR.
2. Select Configure Profile from the Step list.
3. Select Show from the Action list.

Figure 358: Displaying MVR Group Address Profiles

Multicast > MVR

Step: 2. Configure Profile Action: Show

MVR Profile List Total: 2

<input type="checkbox"/>	Profile Name	Start IP Address	End IP Address
<input type="checkbox"/>	sales	234.5.6.8	234.5.6.10
<input type="checkbox"/>	rd	234.5.6.7	234.5.6.7

Delete Revert

To assign an MVR group address profile to a domain:

1. Click Multicast, MVR.
2. Select Associate Profile from the Step list.
3. Select Add from the Action list.
4. Select a domain from the scroll-down list, and enter the name of a group profile.
5. Click Apply.

Figure 359: Assigning an MVR Group Address Profile to a Domain

To show the MVR group address profiles assigned to a domain:

1. Click Multicast, MVR.
2. Select Associate Profile from the Step list.
3. Select Show from the Action list.

Figure 360: Showing the MVR Group Address Profiles Assigned to a Domain

<input type="checkbox"/>	Profile Name	Start IP Address	End IP Address
<input type="checkbox"/>	rd	234.5.6.7	234.5.6.7
<input type="checkbox"/>	sales	234.5.6.8	234.5.6.10

CONFIGURING MVR INTERFACE STATUS

Use the Multicast > MVR (Configure Interface) page to configure each interface that participates in the MVR protocol as a source port or receiver port. If you are sure that only one subscriber attached to an interface is receiving multicast services, you can enable the immediate leave function.

CLI REFERENCES

- ◆ ["MVR for IPv4" on page 1281](#)

COMMAND USAGE

- ◆ A port configured as an MVR receiver or source port can join or leave multicast groups configured under MVR. However, note that these ports can also use IGMP snooping to join or leave any other multicast groups using the standard rules for multicast filtering.
- ◆ Receiver ports can belong to different VLANs, but should not be configured as a member of the MVR VLAN. MVR allows a receiver port to dynamically join or leave multicast groups sourced through the MVR VLAN. Multicast groups can also be statically assigned to a receiver port (see ["Assigning Static MVR Multicast Groups to Interfaces" on page 614](#)).

Receiver ports should not be statically configured as a member of the MVR VLAN. If so configured, its MVR status will be inactive. Also, note that VLAN membership for MVR receiver ports cannot be set to access mode (see ["Adding Static Members to VLANs" on page 205](#)).

- ◆ One or more interfaces may be configured as MVR source ports. A source port is able to both receive and send data for configured MVR groups or for groups which have been statically assigned (see ["Assigning Static MVR Multicast Groups to Interfaces" on page 614](#)).

All source ports must belong to the MVR VLAN.

Subscribers should not be directly connected to source ports.

- ◆ Immediate leave applies only to receiver ports. When enabled, the receiver port is immediately removed from the multicast group identified in the leave message. When immediate leave is disabled, the switch follows the standard rules by sending a query message to the receiver port and waiting for a response to determine if there are any remaining subscribers for that multicast group before removing the port from the group list.
 - Using immediate leave can speed up leave latency, but should only be enabled on a port attached to one multicast subscriber to avoid disrupting services to other group members attached to the same interface.
 - Immediate leave does not apply to multicast groups which have been statically assigned to a port.

PARAMETERS

These parameters are displayed:

- ◆ **Domain ID** – An independent multicast domain. (Range: 1-5)
- ◆ **Port/Trunk** – Interface identifier.
- ◆ **Type** – The following interface types are supported:
 - **Source** – An uplink port that can send and receive multicast data for the groups assigned to the MVR VLAN. Note that the source port must be manually configured as a member of the MVR VLAN (see ["Adding Static Members to VLANs" on page 205](#)).
 - **Receiver** – A subscriber port that can receive multicast data sent through the MVR VLAN. Any port configured as a receiver port will be dynamically added to the MVR VLAN when it forwards an IGMP report or join message from an attached host requesting any of the designated multicast services supported by the MVR VLAN. Just remember that only IGMP version 2 or 3 hosts can issue multicast join or leave messages. If MVR must be configured for an IGMP version 1 host, the multicast groups must be statically assigned (see ["Assigning Static MVR Multicast Groups to Interfaces" on page 614](#)).

- **Non-MVR** – An interface that does not participate in the MVR VLAN. (This is the default type.)
- ◆ **Forwarding Status** – Shows if MVR traffic is being forwarded or discarded.
- ◆ **MVR Status** – Shows the MVR status. MVR status for source ports is “Active” if MVR is globally enabled on the switch. MVR status for receiver ports is “Active” only if there are subscribers receiving multicast traffic from one of the MVR groups, or a multicast group has been statically assigned to an interface.
- ◆ **Immediate Leave** – Configures the switch to immediately remove an interface from a multicast stream as soon as it receives a leave message for that group. This option only applies to an interface configured as an MVR receiver. (Default: Disabled)
 - **By Group** – The receiver port is immediately removed from the multicast group identified in the leave message.
 - **By Host IP** – The router/querier will not send out a group-specific query when an IGMPv2/v3 leave message is received (the same as it would without this option having been used). Instead of immediately deleting that group, it will look up the record, and only delete the group if there are no other subscribers for it on the member port. Only when all hosts on that port leave the group will the member port be deleted.

WEB INTERFACE

To configure interface settings for MVR:

1. Click Multicast, MVR.
2. Select Configure Interface from the Step list.
3. Select Port or Trunk interface.
4. Select an MVR domain.
5. Set each port that will participate in the MVR protocol as a source port or receiver port, and optionally enable Immediate Leave on any receiver port to which only one subscriber is attached.
6. Click Apply.

Figure 361: Configuring Interface Settings for MVR

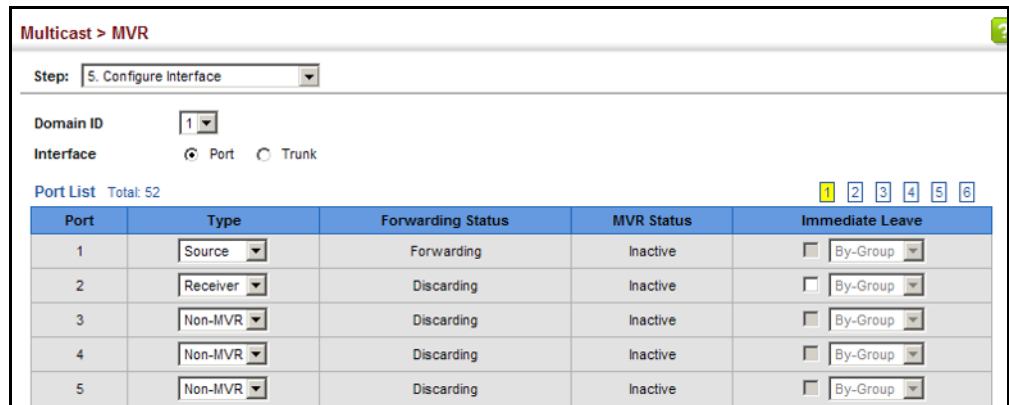

**ASSIGNING
STATIC MVR
MULTICAST GROUPS
TO INTERFACES**

Use the Multicast > MVR (Configure Static Group Member) page to statically bind multicast groups to a port which will receive long-term multicast streams associated with a stable set of hosts.

CLI REFERENCES

- ◆ "mvr vlan group" on page 1292

COMMAND USAGE

- ◆ Multicast groups can be statically assigned to a receiver port using this configuration page.
- ◆ The IP address range from 224.0.0.0 to 239.255.255.255 is used for multicast streams. MVR group addresses cannot fall within the reserved IP multicast address range of 224.0.0.x.
- ◆ Only IGMP version 2 or 3 hosts can issue multicast join or leave messages. If MVR must be configured for an IGMP version 1 host, the multicast groups must be statically assigned.
- ◆ The MVR VLAN cannot be specified as the receiver VLAN for static bindings.

PARAMETERS

These parameters are displayed:

- ◆ **Domain ID** – An independent multicast domain. (Range: 1-5)
- ◆ **Interface** – Port or trunk identifier.
- ◆ **VLAN** – VLAN identifier. (Range: 1-4094)
- ◆ **Group IP Address** – Defines a multicast service sent to the selected port. Multicast groups must be assigned from the MVR group range configured on the Configure General page.

WEB INTERFACE

To assign a static MVR group to an interface:

1. Click Multicast, MVR.
2. Select Configure Static Group Member from the Step list.
3. Select Add from the Action list.
4. Select an MVR domain.
5. Select a VLAN and interface to receive the multicast stream, and then enter the multicast group address.
6. Click Apply.

Figure 362: Assigning Static MVR Groups to an Interface

The screenshot shows a web interface for configuring Multicast VLAN Registration (MVR). The breadcrumb is 'Multicast > MVR'. The current step is '5. Configure Static Group Member' and the action is 'Add'. The configuration fields are as follows:

- Domain ID: 1
- Interface: Port 2 (selected), Trunk (unselected)
- VLAN: 2
- Group IP Address: 234.5.6.8

Buttons for 'Apply' and 'Revert' are located at the bottom right of the form.

To show the static MVR groups assigned to an interface:

1. Click Multicast, MVR.
2. Select Configure Static Group Member from the Step list.
3. Select Show from the Action list.
4. Select an MVR domain.
5. Select the port or trunk for which to display this information.

Figure 363: Showing the Static MVR Groups Assigned to a Port

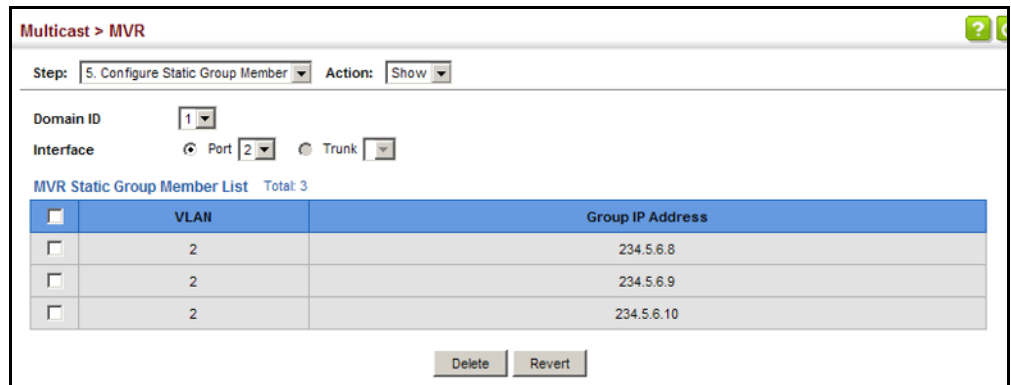

DISPLAYING MVR RECEIVER GROUPS

Use the Multicast > MVR (Show Member) page to show the multicast groups either statically or dynamically assigned to the MVR receiver groups on each interface.

CLI REFERENCES

- ◆ "show mvr" on page 1293

PARAMETERS

These parameters are displayed:

- ◆ **Domain ID** – An independent multicast domain. (Range: 1-5)
- ◆ **Group IP Address** – Multicast groups assigned to the MVR VLAN.
- ◆ **VLAN** – Indicates the MVR VLAN receiving the multicast service. Note that this may be different from the MVR VLAN if the group address has been statically assigned.
- ◆ **Port** – Shows the interfaces with subscribers for multicast services provided through the MVR VLAN.
- ◆ **Up Time** – Time this service has been forwarded to attached clients.
- ◆ **Expire** – Time before this entry expires if no membership report is received from currently active or new clients.
- ◆ **Count** – The number of multicast services currently being forwarded from the MVR VLAN.

WEB INTERFACE

To display the interfaces assigned to the MVR receiver groups:

1. Click Multicast, MVR.
2. Select Show Member from the Step list.
3. Select an MVR domain.

Figure 364: Displaying MVR Receiver Groups

Group IP Address	VLAN	Port	Up Time	Expire	Count
224.1.1.1	2		00:00:30		2 (Port)
	2	Unit 1 / Port 1 (Source)			
	1	Unit 1 / Port 2 (Receiver)	00:01:10	00:00	4 (Host)
224.1.1.2	4		00:00:50		4 (Port)
	4	Unit 1 / Port 3 (Source)			
	5	Unit 1 / Port 4 (Receiver)			
	6	Unit 1 / Port 5 (Source)			
	7	Unit 1 / Port 6 (Receiver)	00:01:10	00:00	1 (Host)

DISPLAYING MVR STATISTICS Use the Multicast > MVR > Show Statistics pages to display MVR protocol-related statistics for the specified interface.

CLI REFERENCES

- ◆ "show mvr statistics" on page 1298

PARAMETERS

These parameters are displayed:

- ◆ **Domain ID** – An independent multicast domain. (Range: 1-5)
- ◆ **VLAN** – VLAN identifier. (Range: 1-4094)
- ◆ **Port** – Port identifier. (Range: 1-28/52)
- ◆ **Trunk** – Trunk identifier. (Range: 1-16)

Query Statistics

- ◆ **Querier IP Address** – The IP address of the querier on this interface.
- ◆ **Querier Expire Time** – The time after which this querier is assumed to have expired.
- ◆ **General Query Received** – The number of general queries received on this interface.
- ◆ **General Query Sent** – The number of general queries sent from this interface.
- ◆ **Specific Query Received** – The number of specific queries received on this interface.
- ◆ **Specific Query Sent** – The number of specific queries sent from this interface.

- ◆ **Number of Reports Sent** – The number of reports sent from this interface.
- ◆ **Number of Leaves Sent** – The number of leaves sent from this interface.

VLAN, Port, and Trunk Statistics

Input Statistics

- ◆ **Report** – The number of IGMP membership reports received on this interface.
- ◆ **Leave** – The number of leave messages received on this interface.
- ◆ **G Query** – The number of general query messages received on this interface.
- ◆ **G(-S)-S Query** – The number of group specific or group-and-source specific query messages received on this interface.
- ◆ **Drop** – The number of times a report, leave or query was dropped. Packets may be dropped due to invalid format, rate limiting, packet content not allowed, or MVR group report received.
- ◆ **Join Success** – The number of times a multicast group was successfully joined.
- ◆ **Group** – The number of MVR groups active on this interface.

Output Statistics

- ◆ **Report** – The number of IGMP membership reports sent from this interface.
- ◆ **Leave** – The number of leave messages sent from this interface.
- ◆ **G Query** – The number of general query messages sent from this interface.
- ◆ **G(-S)-S Query** – The number of group specific or group-and-source specific query messages sent from this interface.

WEB INTERFACE

To display statistics for MVR query-related messages:

1. Click Multicast, MVR.
2. Select Show Statistics from the Step list.
3. Select Show Query Statistics from the Action list.
4. Select an MVR domain.

Figure 365: Displaying MVR Statistics – Query

Multicast > MVR

Step: Action:

Domain ID

Query Statistics

Querier IP Address	None
Querier Expire Time	00(h):00(m):00(s)
General Query Received	0
General Query Sent	0
Specific Query Received	0
Specific Query Sent	0
Number of Reports Sent	0
Number of Leaves Sent	0

[Click this button to clear all MVR statistics of the domain.](#)

To display MVR protocol-related statistics for a VLAN:

1. Click Multicast, MVR.
2. Select Show Statistics from the Step list.
3. Select Show VLAN Statistics from the Action list.
4. Select an MVR domain.
5. Select a VLAN.

Figure 366: Displaying MVR Statistics – VLAN

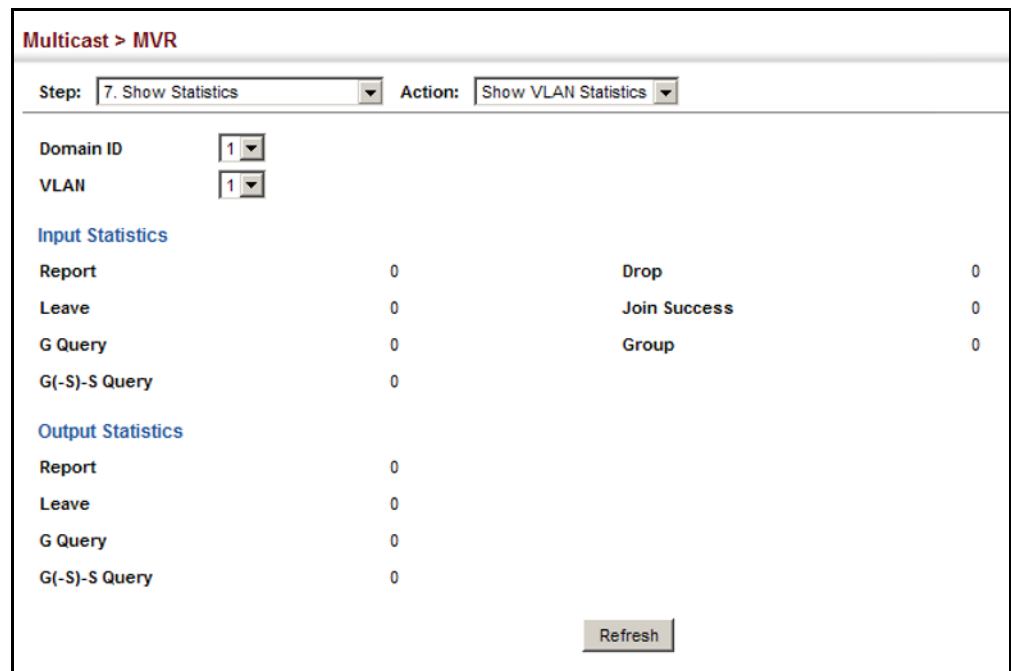

To display MVR protocol-related statistics for a port:

1. Click Multicast, MVR.
2. Select Show Statistics from the Step list.
3. Select Show Port Statistics from the Action list.
4. Select an MVR domain.
5. Select a Port.

Figure 367: Displaying MVR Statistics – Port

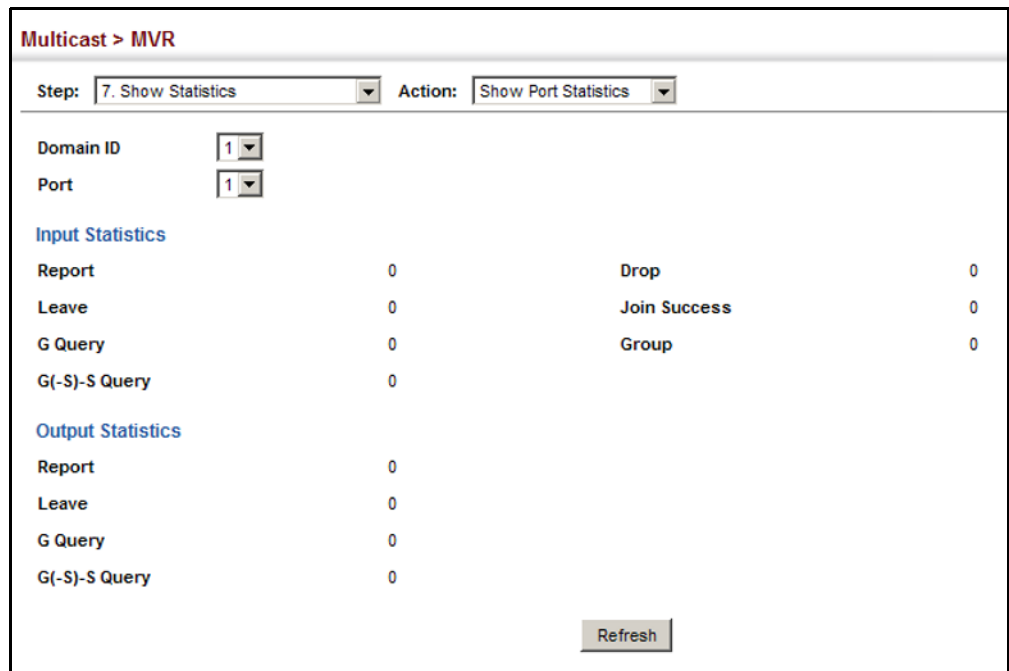

MULTICAST VLAN REGISTRATION FOR IPV6

MVR6 functions in a manner similar to that described for MRV (see ["Multicast VLAN Registration for IPv4" on page 603](#)).

COMMAND USAGE

◆ General Configuration Guidelines for MVR6:

1. Enable MVR6 for a domain on the switch, and select the MVR VLAN (see ["Configuring MVR6 Domain Settings" on page 624](#)).
2. Create an MVR6 profile by specifying the multicast groups that will stream traffic to attached hosts, and assign the profile to an MVR6 domain (see ["Configuring MVR6 Group Address Profiles" on page 625](#)).
3. Set the interfaces that will join the MVR as source ports or receiver ports (see ["Configuring MVR6 Interface Status" on page 628](#)).
4. For multicast streams that will run for a long term and be associated with a stable set of hosts, you can statically bind the multicast group to the participating interfaces (see ["Assigning Static MVR6 Multicast Groups to Interfaces" on page 630](#)).

CONFIGURING MVR6 GLOBAL SETTINGS Use the Multicast > MVR6 (Configure Global) page to configure proxy switching and the robustness variable.

CLI REFERENCES

- ◆ ["MVR for IPv6" on page 1303](#)

PARAMETERS

These parameters are displayed:

- ◆ **Proxy Switching** – Configures MVR proxy switching, where the source port acts as a host, and the receiver port acts as an MVR router with querier service enabled. (Default: Enabled)
 - When MVR proxy-switching is enabled, an MVR source port serves as the upstream or host interface, and the MVR receiver port serves as the querier. The source port performs only the host portion of MVR by sending summarized membership reports, and automatically disables MVR router functions.
 - Receiver ports are known as downstream or router interfaces. These interfaces perform the standard MVR router functions by maintaining a database of all MVR subscriptions on the downstream interface. Receiver ports must therefore be configured on all downstream interfaces which require MVR proxy service.
 - When the source port receives report and leave messages, it only forwards them to other source ports.
 - When receiver ports receive any query messages, they are dropped.
 - When changes occurring in the downstream MVR groups are learned by the receiver ports through report and leave messages, an MVR state change report is created and sent to the upstream source port, which in turn forwards this information upstream.
 - When MVR proxy switching is disabled:
 - Any membership reports received from receiver/source ports are forwarded to all source ports.
 - When a source port receives a query message, it will be forwarded to all downstream receiver ports.
 - When a receiver port receives a query message, it will be dropped.
- ◆ **Robustness Value** – Configures the expected packet loss, and thereby the number of times to generate report and group-specific queries. (Range: 1-10; Default: 2)
 - This parameter is used to set the number of times report messages are sent upstream when changes are learned about downstream groups, and the number of times group-specific queries are sent to downstream receiver ports.
 - This parameter only takes effect when MVR6 proxy switching is enabled.

- ◆ **Proxy Query Interval** – Configures the interval at which the receiver port sends out general queries. (Range: 2-31744 seconds; Default: 125 seconds)
 - This parameter sets the general query interval at which active receiver ports send out general queries.
 - This interval is only effective when proxy switching is enabled.
- ◆ **Source Port Mode** – Configures the switch to forward any multicast streams within the parameters set by a profile, or to only forward multicast streams which the source port has dynamically joined.
 - **Always Forward** – By default, the switch forwards any multicast streams within the address range set by a profile, and bound to a domain. The multicast streams are sent to all source ports on the switch and to all receiver ports that have elected to receive data on that multicast address.
 - **Dynamic** – When dynamic mode is enabled, the switch only forwards multicast streams which the source port has dynamically joined. In other words, both the receiver port and source port must subscribe to a multicast group before a multicast stream is forwarded to any attached client. Note that the requested streams are still restricted to the address range which has been specified in a profile and bound to a domain.

WEB INTERFACE

To configure global settings for MVR6:

1. Click Multicast, MVR6.
2. Select Configure Global from the Step list.
3. Set the status for MVR6 proxy switching, the robustness value used for report and query messages, the proxy query interval, and source port mode.
4. Click Apply.

Figure 368: Configuring Global Settings for MVR6

The screenshot shows a web interface for configuring MVR6 settings. The breadcrumb is 'Multicast > MVR6'. A dropdown menu shows 'Step: 1. Configure Global'. The configuration fields are as follows:

Proxy Switching	<input checked="" type="checkbox"/> Enabled
Robustness Value (1-10)	<input type="text" value="1"/>
Proxy Query Interval (2-31744)	<input type="text" value="125"/> sec
Source Port Mode	<input type="text" value="Always Forward"/>

At the bottom right, there are two buttons: 'Apply' and 'Revert'.

CONFIGURING MVR6 DOMAIN SETTINGS

Use the Multicast > MVR6 (Configure Domain) page to enable MVR6 globally on the switch, and select the VLAN that will serve as the sole channel for common multicast streams supported by the service provider.

CLI REFERENCES

- ◆ ["MVR for IPv6" on page 1303](#)

PARAMETERS

These parameters are displayed:

- ◆ **Domain ID** – An independent multicast domain. (Range: 1-5)
- ◆ **MVR6 Status** – When MVR6 is enabled on the switch, any multicast data associated with an MVR6 group is sent from all designated source ports, to all receiver ports that have registered to receive data from that multicast group. (Default: Disabled)
- ◆ **MVR6 VLAN** – Identifier of the VLAN that serves as the channel for streaming multicast services using MVR6. MVR6 source ports should be configured as members of the MVR6 VLAN (see ["Adding Static Members to VLANs" on page 205](#)), but MVR6 receiver ports should not be manually configured as members of this VLAN. (Default: 1)
- ◆ **MVR6 Running Status** – Indicates whether or not all necessary conditions in the MVR6 environment are satisfied. Running status is Active as long as MVR6 is enabled, the specified MVR6 VLAN exists, and a source port with a valid link has been configured (see ["Configuring MVR6 Interface Status" on page 628](#)).
- ◆ **MVR6 Current Learned Groups** – The number of MVR6 groups currently assigned to this domain.
- ◆ **Forwarding Priority** – The CoS priority assigned to all multicast traffic forwarded into this domain. (Range: 0-7, where 7 is the highest priority)

This parameter can be used to set a high priority for low-latency multicast traffic such as a video-conference, or to set a low priority for normal multicast traffic not sensitive to latency.

- ◆ **Upstream Source IPv6** – The source IPv6 address assigned to all MVR6 control packets sent upstream on the specified domain. This parameter must be a full IPv6 address including the network prefix and host address bits. By default, all MVR6 reports sent upstream use a null source IP address.

All IPv6 addresses must be according to RFC 2373 "IPv6 Addressing Architecture," using 8 colon-separated 16-bit hexadecimal values. One double colon may be used in the address to indicate the appropriate number of zeros required to fill the undefined fields. (Note that the IP address ff02::X is reserved.)

WEB INTERFACE

To configure settings for an MVR6 domain:

1. Click Multicast, MVR6.
2. Select Configure Domain from the Step list.
3. Select a domain from the scroll-down list.
4. Enable MVR6 for the selected domain, select the MVR6 VLAN, set the forwarding priority to be assigned to all ingress multicast traffic, and set the source IP address for all control packets sent upstream as required.
5. Click Apply.

Figure 369: Configuring Domain Settings for MVR6

The screenshot shows the configuration page for MVR6. The breadcrumb is "Multicast > MVR6". The "Step" dropdown is set to "2. Configure Domain". The configuration fields are as follows:

Domain ID	1
MVR6 Status	<input checked="" type="checkbox"/> Enabled
MVR6 VLAN	1
MVR6 Running Status	Active
MVR6 Current Learned Groups	1
Forwarding Priority (0-6)	<input checked="" type="checkbox"/> 0
Upstream Source IPv6	2001:DB8:2222:7272::72

At the bottom right, there are "Apply" and "Revert" buttons.

CONFIGURING MVR6 GROUP ADDRESS PROFILES

Use the Multicast > MVR6 (Configure Profile and Associate Profile) pages to assign the multicast group address for required services to one or more MVR6 domains.

CLI REFERENCES

- ◆ "MVR for IPv6" on page 1303

COMMAND USAGE

- ◆ Use the Configure Profile page to statically configure all multicast group addresses that will join the MVR6 VLAN. Any multicast data associated with an MVR6 group is sent from all source ports to all receiver ports that have registered to receive data from that multicast group.
- ◆ All IPv6 addresses must be according to RFC 2373 "IPv6 Addressing Architecture," using 8 colon-separated 16-bit hexadecimal values. One double colon may be used in the address to indicate the appropriate number of zeros required to fill the undefined fields. (Note that the IP address ff02::X is reserved.)

- ◆ The MVR6 group address range assigned to a profile cannot overlap with the group address range of any other profile.
- ◆ MVR6 domains can be associated with more than one MVR6 profile. But since MVR6 domains cannot share the group range, an MVR6 profile can only be associated with one MVR6 domain.

PARAMETERS

These parameters are displayed:

Configure Profile

- ◆ **Profile Name** – The name of a profile containing one or more MVR6 group addresses. (Range: 1-21 characters)
- ◆ **Start IPv6 Address** – Starting IP address for an MVR6 multicast group. This parameter must be a full IPv6 address including the network prefix and host address bits.
- ◆ **End IPv6 Address** – Ending IP address for an MVR6 multicast group. This parameter must be a full IPv6 address including the network prefix and host address bits.

Associate Profile

- ◆ **Domain ID** – An independent multicast domain. (Range: 1-5)
- ◆ **Profile Name** – The name of a profile to be assigned to this domain. (Range: 1-21 characters)

WEB INTERFACE

To configure an MVR6 group address profile:

1. Click Multicast, MVR6.
2. Select Configure Profile from the Step list.
3. Select Add from the Action list.
4. Enter the name of a group profile to be assigned to one or more domains, and specify a multicast group that will stream traffic to participating hosts.
5. Click Apply.

Figure 370: Configuring an MVR6 Group Address Profile

Multicast > MVR6

Step: 3. Configure Profile Action: Add

Profile Name: rd

Start IPv6 Address: FF08::1

End IPv6 Address: FF08::9

Apply Revert

To show the configured MVR6 group address profiles:

1. Click Multicast, MVR6.
2. Select Configure Profile from the Step list.
3. Select Show from the Action list.

Figure 371: Displaying MVR6 Group Address Profiles

Multicast > MVR6

Step: 3. Configure Profile Action: Show

MVR6 Profile List Total: 1

<input type="checkbox"/>	Profile Name	Start IPv6 Address	End IPv6 Address
<input type="checkbox"/>	rd	FF08::1	FF08::9

Delete Revert

To assign an MVR6 group address profile to a domain:

1. Click Multicast, MVR6.
2. Select Associate Profile from the Step list.
3. Select Add from the Action list.
4. Select a domain from the scroll-down list, and enter the name of a group profile.
5. Click Apply.

Figure 372: Assigning an MVR6 Group Address Profile to a Domain

Multicast > MVR6

Step: 4. Associate Profile Action: Add

Domain ID: 1

Profile Name: rd

Apply Revert

To show the MVR6 group address profiles assigned to a domain:

1. Click Multicast, MVR6.
2. Select Associate Profile from the Step list.
3. Select Show from the Action list.

Figure 373: Showing MVR6 Group Address Profiles Assigned to a Domain

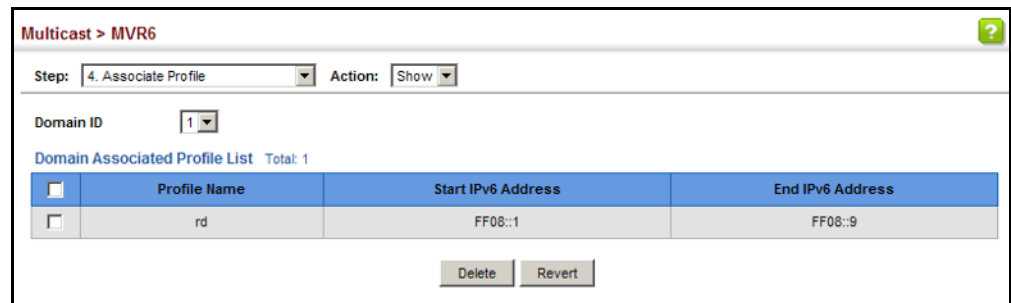

CONFIGURING MVR6 INTERFACE STATUS

Use the Multicast > MVR6 (Configure Interface) page to configure each interface that participates in the MVR6 protocol as a source port or receiver port. If you are sure that only one subscriber attached to an interface is receiving multicast services, you can enable the immediate leave function.

CLI REFERENCES

- ◆ ["MVR for IPv6" on page 1303](#)

COMMAND USAGE

- ◆ A port configured as an MVR6 receiver or source port can join or leave multicast groups configured under MVR6.
- ◆ Receiver ports can belong to different VLANs, but should not be configured as a member of the MVR6 VLAN. MVR6 allows a receiver port to dynamically join or leave multicast groups sourced through the MVR6 VLAN. Multicast groups can also be statically assigned to a receiver port (see ["Assigning Static MVR6 Multicast Groups to Interfaces" on page 630](#)).

Receiver ports should not be statically configured as a member of the MVR6 VLAN. If so configured, its MVR6 status will be inactive. Also, note that VLAN membership for MVR6 receiver ports cannot be set to access mode (see ["Adding Static Members to VLANs" on page 205](#)).

- ◆ One or more interfaces may be configured as MVR6 source ports. A source port is able to both receive and send data for configured MVR6 groups or for groups which have been statically assigned (see ["Assigning Static MVR6 Multicast Groups to Interfaces" on page 630](#)).

All source ports must belong to the MVR6 VLAN.

Subscribers should not be directly connected to source ports.

- ◆ Immediate leave applies only to receiver ports. When enabled, the receiver port is immediately removed from the multicast group identified in the leave message. When immediate leave is disabled, the switch follows the standard rules by sending a group-specific query to the receiver port and waiting for a response to determine if there are any remaining subscribers for that multicast group before removing the port from the group list.
 - Using immediate leave can speed up leave latency, but should only be enabled on a port attached to one multicast subscriber to avoid disrupting services to other group members attached to the same interface.
 - Immediate leave does not apply to multicast groups which have been statically assigned to a port.

PARAMETERS

These parameters are displayed:

- ◆ **Domain ID** – An independent multicast domain. (Range: 1-5)
- ◆ **Port/Trunk** – Interface identifier.
- ◆ **Type** – The following interface types are supported:
 - **Non-MVR6** – An interface that does not participate in the MVR6 VLAN. (This is the default type.)
 - **Source** – An uplink port that can send and receive multicast data for the groups assigned to the MVR6 VLAN. Note that the source port must be manually configured as a member of the MVR6 VLAN (see ["Adding Static Members to VLANs" on page 205](#)).
 - **Receiver** – A subscriber port that can receive multicast data sent through the MVR6 VLAN. Also, note that VLAN membership for MVR receiver ports cannot be set to access mode (see ["Adding Static Members to VLANs" on page 205](#)).
- ◆ **Forwarding Status** – Shows if multicast traffic is being forwarded or blocked.
- ◆ **MVR6 Status** – Shows the MVR6 status. MVR6 status for source ports is "Active" if MVR6 is globally enabled on the switch. MVR6 status for receiver ports is "Active" only if there are subscribers receiving multicast traffic from one of the MVR6 groups, or a multicast group has been statically assigned to an interface.
- ◆ **Immediate Leave** – Configures the switch to immediately remove an interface from a multicast stream as soon as it receives a leave message for that group. This option only applies to an interface configured as an MVR receiver. (Default: Disabled)
 - **By Group** – The receiver port is immediately removed from the multicast group identified in the leave message.

- **By Host IP** – The router/querier will not send out a group-specific query when an MLDv1/v2 Listener Done message is received (the same as it would without this option having been used). Instead of immediately deleting that group, it will look up the record, and only delete the group if there are no other subscribers for it on the member port. Only when all hosts on that port leave the group will the member port be deleted.

WEB INTERFACE

To configure interface settings for MVR6:

1. Click Multicast, MVR6.
2. Select Configure Interface from the Step list.
3. Select Port or Trunk interface.
4. Select an MVR6 domain.
5. Set each port that will participate in the MVR6 protocol as a source port or receiver port, and optionally enable Immediate Leave on any receiver port to which only one subscriber is attached.
6. Click Apply.

Figure 374: Configuring Interface Settings for MVR6

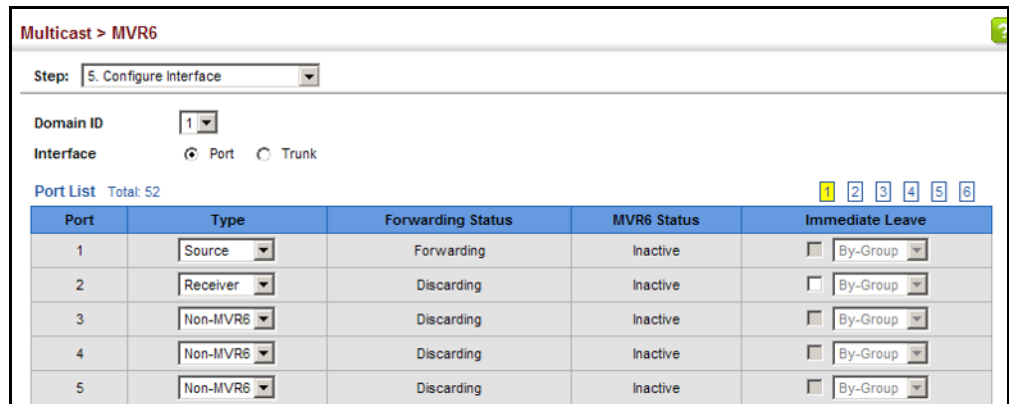

ASSIGNING STATIC MVR6 MULTICAST GROUPS TO INTERFACES

Use the Multicast > MVR6 (Configure Static Group Member) page to statically bind multicast groups to a port which will receive long-term multicast streams associated with a stable set of hosts.

CLI REFERENCES

- ◆ "mvr6 vlan group" on page 1313

COMMAND USAGE

- ◆ Multicast groups can be statically assigned to a receiver port using this configuration page.

- ◆ All IPv6 addresses must be according to RFC 2373 "IPv6 Addressing Architecture," using 8 colon-separated 16-bit hexadecimal values. One double colon may be used in the address to indicate the appropriate number of zeros required to fill the undefined fields. (Note that the IP address ff02::X is reserved.)
- ◆ The MVR6 VLAN cannot be specified as the receiver VLAN for static bindings.

PARAMETERS

These parameters are displayed:

- ◆ **Domain ID** – An independent multicast domain. (Range: 1-5)
- ◆ **Interface** – Port or trunk identifier.
- ◆ **VLAN** – VLAN identifier. (Range: 1-4094)
- ◆ **Group IPv6 Address** – Defines a multicast service sent to the selected port. Multicast groups must be assigned from the MVR6 group range configured on the Configure General page.

WEB INTERFACE

To assign a static MVR6 group to an interface:

1. Click Multicast, MVR6.
2. Select Configure Static Group Member from the Step list.
3. Select Add from the Action list.
4. Select an MVR6 domain.
5. Select a VLAN and interface to receive the multicast stream, and then enter the multicast group address.
6. Click Apply.

Figure 375: Assigning Static MVR6 Groups to a Port

The screenshot shows a web interface for configuring MVR6. At the top, it says "Multicast > MVR6". Below that, there are two dropdown menus: "Step: 6. Configure Static Group Member" and "Action: Add". The main configuration area has several fields: "Domain ID" with a dropdown set to "1"; "Interface" with radio buttons for "Port" (selected) and "Trunk", and a dropdown set to "2"; "VLAN" with a dropdown set to "2"; and "Group IPv6 Address" with a text input field containing "ff08::1". At the bottom right, there are two buttons: "Apply" and "Revert".

To show the static MVR6 groups assigned to an interface:

1. Click Multicast, MVR6.
2. Select Configure Static Group Member from the Step list.
3. Select Show from the Action list.
4. Select an MVR6 domain.
5. Select the port or trunk for which to display this information.

Figure 376: Showing the Static MVR6 Groups Assigned to a Port

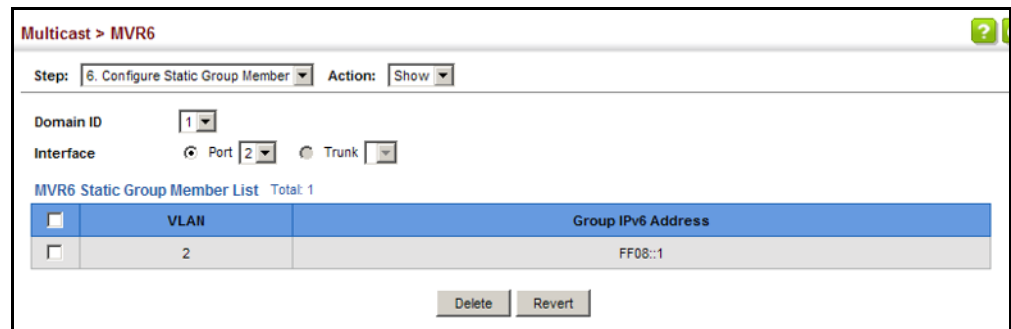

DISPLAYING MVR6 RECEIVER GROUPS

Use the Multicast > MVR6 (Show Member) page to show the multicast groups either statically or dynamically assigned to the MVR6 receiver groups on each interface.

CLI REFERENCES

- ◆ ["show mvr6 members" on page 1318](#)

PARAMETERS

These parameters are displayed:

- ◆ **Domain ID** – An independent multicast domain. (Range: 1-5)
- ◆ **Group IPv6 Address** – Multicast groups assigned to the MVR6 VLAN.
- ◆ **VLAN** – The VLAN through which the service is received. Note that this may be different from the MVR6 VLAN if the group address has been statically assigned.
- ◆ **Port** – Indicates the source address of the multicast service, or displays an asterisk if the group address has been statically assigned (these entries are marked as "Source"). Also shows the interfaces with subscribers for multicast services provided through the MVR6 VLAN (these entries are marked as "Receiver").
- ◆ **Up Time** – Time this service has been forwarded to attached clients.

- ◆ **Expire** – Time before this entry expires if no membership report is received from currently active or new clients.
- ◆ **Count** – The number of multicast services currently being forwarded from the MVR6 VLAN.

WEB INTERFACE

To display the interfaces assigned to the MVR6 receiver groups:

1. Click Multicast, MVR6.
2. Select Show Member from the Step list.
3. Select an MVR6 domain.

Figure 377: Displaying MVR6 Receiver Groups

Group IPv6 Address	VLAN	Port	Up Time	Expire	Count
FF08::1	1		00:00:01:41		2 (Port)
	1	Unit 1 / Port 1 (Source)			
	2	Unit 1 / Port 2 (Receiver)			0 (Host)

DISPLAYING MVR6 STATISTICS Use the Multicast > MVR6 > Show Statistics pages to display MVR6 protocol-related statistics for the specified interface.

CLI REFERENCES

- ◆ "show mvr6 statistics" on page 1320

PARAMETERS

These parameters are displayed:

- ◆ **Domain ID** – An independent multicast domain. (Range: 1-5)
- ◆ **VLAN** – VLAN identifier. (Range: 1-4094)
- ◆ **Port** – Port identifier. (Range: 1-28/52)
- ◆ **Trunk** – Trunk identifier. (Range: 1-16)

Query Statistics

- ◆ **Querier IPv6 Address** – The IP address of the querier on this interface.
- ◆ **Querier Expire Time** – The time after which this querier is assumed to have expired.

- ◆ **General Query Received** – The number of general queries received on this interface.
- ◆ **General Query Sent** – The number of general queries sent from this interface.
- ◆ **Specific Query Received** – The number of specific queries received on this interface.
- ◆ **Specific Query Sent** – The number of specific queries sent from this interface.
- ◆ **Number of Reports Sent** – The number of reports sent from this interface.
- ◆ **Number of Leaves Sent** – The number of leaves sent from this interface.

VLAN, Port, and Trunk Statistics

Input Statistics

- ◆ **Report** – The number of MLD membership reports received on this interface.
- ◆ **Leave** – The number of leave messages received on this interface.
- ◆ **G Query** – The number of general query messages received on this interface.
- ◆ **G(-S)-S Query** – The number of group specific or group-and-source specific query messages received on this interface.
- ◆ **Drop** – The number of times a report, leave or query was dropped. Packets may be dropped due to invalid format, rate limiting, packet content not allowed, or MVR6 group report received.
- ◆ **Join Success** – The number of times a multicast group was successfully joined.
- ◆ **Group** – The number of MVR6 groups active on this interface.

Output Statistics

- ◆ **Report** – The number of MLD membership reports sent from this interface.
- ◆ **Leave** – The number of leave messages sent from this interface.
- ◆ **G Query** – The number of general query messages sent from this interface.
- ◆ **G(-S)-S Query** – The number of group specific or group-and-source specific query messages sent from this interface.

WEB INTERFACE

To display statistics for MVR6 query-related messages:

1. Click Multicast, MVR6.
2. Select Show Statistics from the Step list.
3. Select Show Query Statistics from the Action list.
4. Select an MVR6 domain.

Figure 378: Displaying MVR6 Statistics – Query

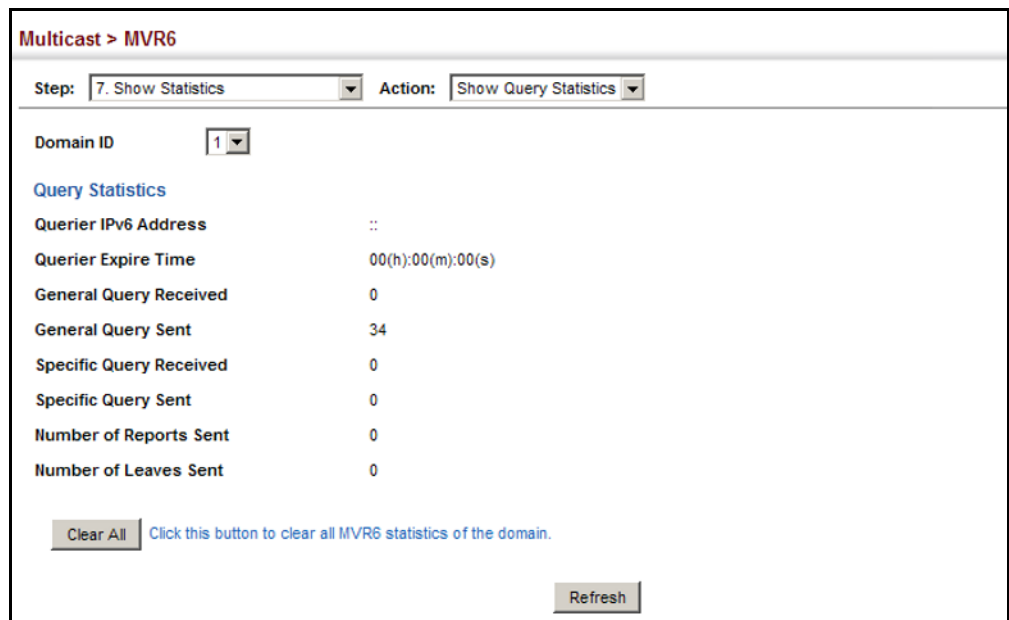

To display MVR6 protocol-related statistics for a VLAN:

1. Click Multicast, MVR6.
2. Select Show Statistics from the Step list.
3. Select Show VLAN Statistics from the Action list.
4. Select an MVR6 domain.
5. Select a VLAN.

Figure 379: Displaying MVR6 Statistics – VLAN

Multicast > MVR6

Step: 7. Show Statistics Action: Show VLAN Statistics

Domain ID: 1
VLAN: 1

Input Statistics

Report	0	Drop	0
Done	0	Join Success	0
G Query	0	Group	1
G(-S)-S Query	0		

Output Statistics

Report	0		
Done	0		
G Query	35		
G(-S)-S Query	0		

Clear Refresh

To display MVR6 protocol-related statistics for a port:

1. Click Multicast, MVR6.
2. Select Show Statistics from the Step list.
3. Select Show Port Statistics from the Action list.
4. Select an MVR6 domain.
5. Select a Port.

Figure 380: Displaying MVR6 Statistics – Port

Multicast > MVR6

Step: 7. Show Statistics Action: Show Port Statistics

Domain ID 1

Port 1

Input Statistics

Report	0	Drop	0
Done	0	Join Success	0
G Query	0	Group	0
G(-S)-S Query	0		

Output Statistics

Report	12
Done	1
G Query	0
G(-S)-S Query	0

Clear
Refresh

This chapter describes how to configure an IP interface for management access to the switch over the network. This switch supports both IP Version 4 and Version 6, and can be managed simultaneously through either of these address types. You can manually configure a specific IPv4 or IPv6 address, or direct the switch to obtain an IPv4 address from a BOOTP or DHCP server. An IPv6 address can either be manually configured or dynamically generated.

This chapter provides information on network functions including:

- ◆ [IPv4 Configuration](#) – Sets an IPv4 address for management access.
- ◆ [IPv6 Configuration](#) – Sets an IPv6 address for management access.

SETTING THE SWITCH'S IP ADDRESS (IP VERSION 4)

Use the IP > General > Routing Interface (Add) page to configure an IPv4 address for the switch. An IPv4 address is obtained via DHCP by default for VLAN 1. To configure a static address, you need to change the switch's default settings to values that are compatible with your network. You may also need to establish a default gateway between the switch and management stations that exist on another network segment (if no routing protocols are enabled).

You can direct the device to obtain an address from a BOOTP or DHCP server, or manually configure a static IP address. Valid IP addresses consist of four decimal numbers, 0 to 255, separated by periods. Anything other than this format will not be accepted.

CLI REFERENCES

- ◆ ["DHCP Client" on page 1411](#)
- ◆ ["Basic IPv4 Configuration" on page 1422](#)

COMMAND USAGE

- ◆ This section describes how to configure a single local interface for initial access to the switch. To configure multiple IP interfaces, set up an IP interface for each VLAN.
- ◆ Once an IP address has been assigned to an interface, routing between different interfaces on the switch is enabled.

- ◆ To enable routing between interfaces defined on this switch and external network interfaces, you must configure static routes ([page 1468](#)).
- ◆ The precedence for configuring IP interfaces is the IP > General > Routing Interface (Add Address) menu, and then static routes.

PARAMETERS

These parameters are displayed:

- ◆ **VLAN** – ID of the configured VLAN (1-4094). By default, all ports on the switch are members of VLAN 1. However, the management station can be attached to a port belonging to any VLAN, as long as that VLAN has been assigned an IP address.
- ◆ **IP Address Mode** – Specifies whether IP functionality is enabled via manual configuration (User Specified), Dynamic Host Configuration Protocol (DHCP), or Boot Protocol (BOOTP). If DHCP/BOOTP is enabled, IP will not function until a reply has been received from the server. Requests will be broadcast periodically by the switch for an IP address. DHCP/BOOTP responses can include the IP address, subnet mask, and default gateway. (Default: DHCP)

- ◆ **IP Address Type** – Specifies a primary or secondary IP address. An interface can have only one primary IP address, but can have many secondary IP addresses. In other words, secondary addresses need to be specified if more than one IP subnet can be accessed through this interface. For initial configuration, set this parameter to Primary. (Options: Primary, Secondary; Default: Primary)

Note that a secondary address cannot be configured prior to setting the primary IP address, and the primary address cannot be removed if a secondary address is still present. Also, if any router in a network segment uses a secondary address, all other routers in that segment must also use a secondary address from the same network or subnet address space.

- ◆ **IP Address** – IP Address of the VLAN. Valid IP addresses consist of four numbers, 0 to 255, separated by periods. (Default: None)



NOTE: You can manage the switch through any configured IP interface.

- ◆ **Subnet Mask** – This mask identifies the host address bits used for routing to specific subnets. (Default: None)
- ◆ **Restart DHCP** – Requests a new IP address from the DHCP server.

WEB INTERFACE

To set a static address for the switch:

1. Click IP, General, Routing Interface.
2. Select Add Address from the Action list.
3. Select any configured VLAN, set IP Address Mode to "User Specified," set IP Address Type to "Primary" if no address has yet been configured for this interface, and then enter the IP address and subnet mask.
4. Click Apply.

Figure 381: Configuring a Static IPv4 Address

IP > General > Routing Interface

Action: Add Address

VLAN: 1

IP Address Mode: User Specified

IP Address Type: Primary

IP Address: 192.168.0.2

Subnet Mask: 255.255.255.0

Restart DHCP [Click this button to restart DHCP service.](#)

Apply Revert

To obtain an dynamic address through DHCP/BOOTP for the switch:

1. Click IP, General, Routing Interface.
2. Select Add Address from the Action list.
3. Select any configured VLAN, and set IP Address Mode to "BOOTP" or "DHCP."
4. Click Apply.

IP will be enabled but will not function until a BOOTP or DHCP reply is received. Requests are broadcast every few minutes using exponential backoff until IP configuration information is obtained from a BOOTP or DHCP server.

Figure 382: Configuring a Dynamic IPv4 Address

The screenshot shows a web interface for configuring a dynamic IPv4 address. The breadcrumb path is "IP > General > Routing Interface". The "Action" dropdown is set to "Add Address". The "VLAN" dropdown is set to "1". The "IP Address Mode" dropdown is set to "DHCP". The "IP Address Type" dropdown is set to "Primary". There are empty text input fields for "IP Address" and "Subnet Mask". At the bottom, there is a "Restart DHCP" button with a tooltip that says "Click this button to restart DHCP service.", and "Apply" and "Revert" buttons.



NOTE: The switch will also broadcast a request for IP configuration settings on each power reset.

NOTE: If you lose the management connection, make a console connection to the switch and enter "show ip interface" to determine the new switch address.

Renewing DHCP – DHCP may lease addresses to clients indefinitely or for a specific period of time. If the address expires or the switch is moved to another network segment, you will lose management access to the switch. In this case, you can reboot the switch or submit a client request to restart DHCP service via the CLI.

If the address assigned by DHCP is no longer functioning, you will not be able to renew the IP settings via the web interface. You can only restart DHCP service via the web interface if the current address is still available.

To show the address configured for an interface:

1. Click IP, General, Routing Interface.
2. Select Show Address from the Action list.
3. Select an entry from the VLAN list.

Figure 383: Showing the Configured IP Address for an Interface

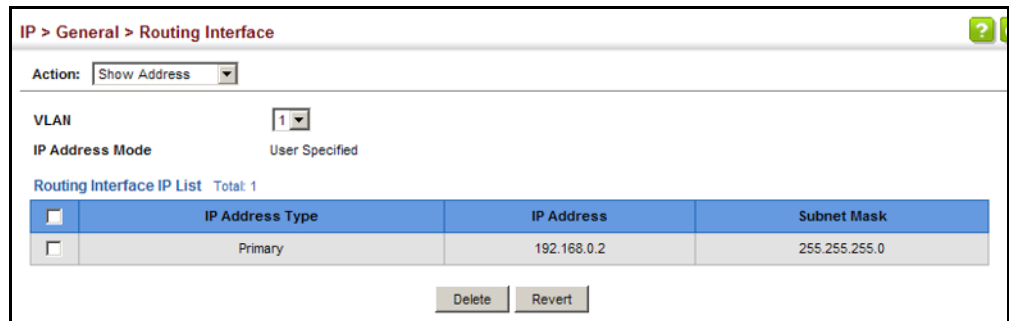

SETTING THE SWITCH'S IP ADDRESS (IP VERSION 6)

This section describes how to configure an IPv6 interface for management access over the network, or for creating an interface to multiple subnets. This switch supports both IPv4 and IPv6, and can be managed through either of these address types. For information on configuring the switch with an IPv4 address, see ["Setting the Switch's IP Address \(IP Version 4\)" on page 639](#).

COMMAND USAGE

- ◆ IPv6 includes two distinct address types – link-local unicast and global unicast. A link-local address makes the switch accessible over IPv6 for all devices attached to the same local subnet. Management traffic using this kind of address cannot be passed by any router outside of the subnet. A link-local address is easy to set up, and may be useful for simple networks or basic troubleshooting tasks. However, to connect to a larger network with multiple segments, the switch must be configured with a global unicast address. Both link-local and global unicast address types can either be dynamically assigned (using the Configure Interface page) or manually configured (using the Add IPv6 Address page).
- ◆ An IPv6 global unicast or link-local address can be manually configured (using the Add IPv6 Address page), or a link-local address can be dynamically generated (using the Configure Interface page).

CONFIGURING THE IPv6 DEFAULT GATEWAY

Use the IP > IPv6 Configuration (Configure Global) page to configure an IPv6 default gateway for the switch.

CLI REFERENCES

- ◆ ["ipv6 default-gateway" on page 1433](#)

PARAMETERS

These parameters are displayed:

- ◆ **Default Gateway** – Sets the IPv6 address of the default next hop router to use when no routing information is known about an IPv6 address.
 - If no static routes are defined, you must define a gateway if the target device is located in a different subnet.
 - An IPv6 default gateway can only be successfully set when a network interface that directly connects to the gateway has been configured on the switch.
 - An IPv6 address must be configured according to RFC 2373 “IPv6 Addressing Architecture,” using 8 colon-separated 16-bit hexadecimal values. One double colon may be used in the address to indicate the appropriate number of zeros required to fill the undefined fields.

WEB INTERFACE

To configure an IPv6 default gateway for the switch:

1. Click IP, IPv6 Configuration.
2. Select Configure Global from the Action list.
3. Enter the IPv6 default gateway.
4. Click Apply.

Figure 384: Configuring the IPv6 Default Gateway

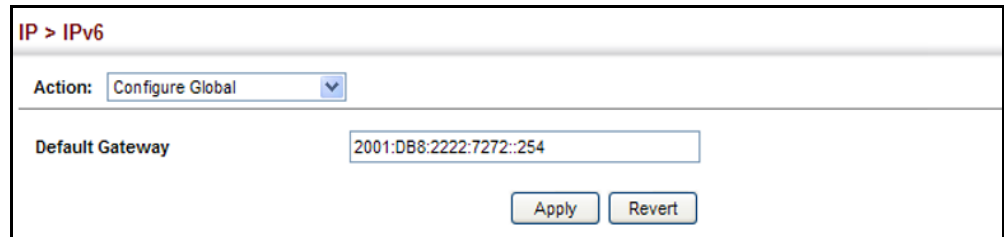

The screenshot shows a web interface for configuring IPv6 settings. At the top, it says "IP > IPv6". Below that, there is a dropdown menu labeled "Action:" with "Configure Global" selected. Underneath, there is a text input field labeled "Default Gateway" containing the IPv6 address "2001:DB8:2222:7272::254". At the bottom right of the form, there are two buttons: "Apply" and "Revert".

CONFIGURING IPv6 INTERFACE SETTINGS

Use the IP > IPv6 Configuration (Configure Interface) page to configure general IPv6 settings for the selected VLAN, including auto-configuration of a global unicast interface address, and explicit configuration of a link local interface address, the MTU size, and neighbor discovery protocol settings for duplicate address detection and the neighbor solicitation interval.

CLI REFERENCES

- ◆ "IPv6 Interface" on page 1432
- ◆ "DHCP Client" on page 1411

COMMAND USAGE

- ◆ The switch must be configured with a link-local address. The switch's address auto-configuration function will automatically create a link-local address, as well as an IPv6 global address if router advertisements are detected on the local interface.
- ◆ The option to explicitly enable IPv6 creates a link-local address, but will not generate a global IPv6 address if auto-configuration is not enabled. In this case, you can manually configure a global unicast address (see ["Configuring an IPv6 Address" on page 650](#)).
- ◆ IPv6 Neighbor Discovery Protocol supersedes IPv4 Address Resolution Protocol in IPv6 networks. IPv6 nodes on the same network segment use Neighbor Discovery to discover each other's presence, to determine each other's link-layer addresses, to find routers and to maintain reachability information about the paths to active neighbors. The key parameters used to facilitate this process are the number of attempts made to verify whether or not a duplicate address exists on the same network segment, and the interval between neighbor solicitations used to verify reachability information.

PARAMETERS

These parameters are displayed:

VLAN Mode

- ◆ **VLAN** – ID of a configured VLAN which is to be used for management access, or as a standard interface for a subnet. By default, all ports on the switch are members of VLAN 1. However, the management station can be attached to a port belonging to any VLAN, as long as that VLAN has been assigned an IP address. (Range: 1-4094)
- ◆ **Address Autoconfig** – Enables stateless autoconfiguration of an IPv6 address on an interface and enables IPv6 functionality on that interface. The network portion of the address is based on prefixes received in IPv6 router advertisement messages, and the host portion is automatically generated using the modified EUI-64 form of the interface identifier (i.e., the switch's MAC address).
 - If a link local address has not yet been assigned to this interface, this command will dynamically generate one. The link-local address is made with an address prefix in the range of FE80~FEBF and a host portion based the switch's MAC address in modified EUI-64 format. It will also generate a global unicast address if a global prefix is included in received router advertisements.
 - When DHCPv6 is started, the switch may attempt to acquire an IP address prefix through stateful address autoconfiguration. If router advertisements have the "other stateful configuration" flag set, the switch will attempt to acquire other non-address configuration information (such as a default gateway).
 - If auto-configuration is not selected, then an address must be manually configured using the Add Interface page described below.

- ◆ **Enable IPv6 Explicitly** – Enables IPv6 on an interface and assigns it a link-local address. Note that when an explicit address is assigned to an interface, IPv6 is automatically enabled, and cannot be disabled until all assigned addresses have been removed. (Default: Disabled)

Disabling this parameter does not disable IPv6 for an interface that has been explicitly configured with an IPv6 address.

MTU – Sets the size of the maximum transmission unit (MTU) for IPv6 packets sent on an interface. (Range: 1280-65535 bytes; Default: 1500 bytes)

- The maximum value set in this field cannot exceed the MTU of the physical interface, which is currently fixed at 1500 bytes.
 - If a non-default value is configured, an MTU option is included in the router advertisements sent from this device. This option is provided to ensure that all nodes on a link use the same MTU value in cases where the link MTU is not otherwise well known.
 - IPv6 routers do not fragment IPv6 packets forwarded from other routers. However, traffic originating from an end-station connected to an IPv6 router may be fragmented.
 - All devices on the same physical medium must use the same MTU in order to operate correctly.
 - IPv6 must be enabled on an interface before the MTU can be set. If an IPv6 address has not been assigned to the switch, "N/A" is displayed in the MTU field.
- ◆ **ND DAD Attempts** – The number of consecutive neighbor solicitation messages sent on an interface during duplicate address detection. (Range: 0-600; Default: 3)
 - Configuring a value of 0 disables duplicate address detection.
 - Duplicate address detection determines if a new unicast IPv6 address already exists on the network before it is assigned to an interface.
 - Duplicate address detection is stopped on any interface that has been suspended (see "[Configuring VLAN Groups](#)" on page 202). While an interface is suspended, all unicast IPv6 addresses assigned to that interface are placed in a "pending" state. Duplicate address detection is automatically restarted when the interface is administratively re-activated.
 - An interface that is re-activated restarts duplicate address detection for all unicast IPv6 addresses on the interface. While duplicate address detection is performed on the interface's link-local address, the other IPv6 addresses remain in a "tentative" state. If no duplicate link-local address is found, duplicate address detection is started for the remaining IPv6 addresses.
 - If a duplicate address is detected, it is set to "duplicate" state, and a warning message is sent to the console. If a duplicate link-local address is detected, IPv6 processes are disabled on the interface. If a duplicate global unicast address is detected, it is not used. All

configuration commands associated with a duplicate address remain configured while the address is in "duplicate" state.

- If the link-local address for an interface is changed, duplicate address detection is performed on the new link-local address, but not for any of the IPv6 global unicast addresses already associated with the interface.

- ◆ **ND NS Interval** – The interval between transmitting IPv6 neighbor solicitation messages on an interface. (Range: 1000-3600000 milliseconds)

Default: 1000 milliseconds is used for neighbor discovery operations, 0 milliseconds is advertised in router advertisements.

This attribute specifies the interval between transmitting neighbor solicitation messages when resolving an address, or when probing the reachability of a neighbor. Therefore, avoid using very short intervals for normal IPv6 operations.

- ◆ **ND Reachable-Time** – The amount of time that a remote IPv6 node is considered reachable after some reachability confirmation event has occurred. (Range: 0-3600000 milliseconds)

Default: 3000 milliseconds is used for neighbor discovery operations, 0 milliseconds is advertised in router advertisements.

- The time limit configured by this parameter allows the router to detect unavailable neighbors. During the neighbor discover process, an IPv6 node will multicast neighbor solicitation messages to search for neighbor nodes. For a neighbor node to be considered reachable, it must respond to the neighbor soliciting node with a neighbor advertisement message to become a confirmed neighbor, after which the reachable timer will be considered in effect for subsequent unicast IPv6 layer communications.
- This time limit is included in all router advertisements sent out through an interface, ensuring that nodes on the same link use the same time value.
- Setting the time limit to 0 means that the configured time is unspecified by this router.

- ◆ **Restart DHCPv6** – When DHCPv6 is restarted, the switch may attempt to acquire an IP address prefix through stateful address autoconfiguration. If the router advertisements have the "other stateful configuration" flag set, the switch may also attempt to acquire other non-address configuration information (such as a default gateway) when DHCPv6 is restarted.

Prior to submitting a client request to a DHCPv6 server, the switch should be configured with a link-local address using the Address Autoconfig option. The state of the Managed Address Configuration flag (M flag) and Other Stateful Configuration flag (O flag) received in Router Advertisement messages will determine the information this

switch should attempt to acquire from the DHCPv6 server as described below.

- Both M and O flags are set to 1:
DHCPv6 is used for both address and other configuration settings.
This combination is known as DHCPv6 stateful autoconfiguration, in which a DHCPv6 server assigns stateful addresses to IPv6 hosts.
- The M flag is set to 0, and the O flag is set to 1:
DHCPv6 is used only for other configuration settings.
Neighboring routers are configured to advertise non-link-local address prefixes from which IPv6 hosts derive stateless addresses.
This combination is known as DHCPv6 stateless autoconfiguration, in which a DHCPv6 server does not assign stateful addresses to IPv6 hosts, but does assign stateless configuration settings.

RA Guard Mode

◆ **Interface** – Shows port or trunk configuration page.

◆ **RA Guard** – Blocks incoming Router Advertisement and Router Redirect packets. (Default: Disabled)

IPv6 Router Advertisements (RA) convey information that enables nodes to auto-configure on the network. This information may include the default router address taken from the observed source address of the RA message, as well as on-link prefix information. However, note that unintended misconfigurations, or possibly malicious attacks on the network, may lead to bogus RAs being sent, which in turn can cause operational problems for hosts on the network.

RA Guard can be used to block RAs and Router Redirect (RR) messages on the specified interface. Determine which interfaces are connected to known routers, and enable RA Guard on all other untrusted interfaces.

WEB INTERFACE

To configure general IPv6 settings for the switch:

1. Click IP, IPv6 Configuration.
2. Select Configure Interface from the Action list.
3. Select VLAN mode.
4. Specify the VLAN to configure.
5. Enable address auto-configuration, or enable IPv6 explicitly to automatically configure a link-local address and enable IPv6 on the selected interface. (To manually configure the link-local address, use the Add IPv6 Address page.) Set the MTU size, the maximum number of duplicate address detection messages, the neighbor solicitation

message interval, and the amount of time that a remote IPv6 node is considered reachable.

6. Click Apply.

Figure 385: Configuring General Settings for an IPv6 Interface

The screenshot shows the 'IP > IPv6 Configuration' page. The 'Action' dropdown is set to 'Configure Interface'. Under 'Mode', 'VLAN' is selected with a radio button. The 'VLAN' dropdown is set to '1'. The 'Address Autoconfig' and 'Enable IPv6 Explicitly' checkboxes are both unchecked. The 'MTU (1280-65535)' is set to '1500' bytes. The 'ND DAD Attempts (0-600)' is set to '3'. The 'ND NS Interval (1000-3600000)' is set to '1000' ms. The 'ND Reachable-Time (0-3600000)' is set to '30000' ms. There is a 'Restart DHCPv6' button and a link 'Click this button to restart DHCPv6 service.' At the bottom right are 'Apply' and 'Revert' buttons.

To configure RA Guard for the switch:

1. Click IP, IPv6 Configuration.
2. Select Configure Interface from the Action list.
3. Select RA Guard mode.
4. Enable RA Guard for untrusted interfaces.
5. Click Apply.

Figure 386: Configuring RA Guard for an IPv6 Interface

The screenshot shows the 'IP > IPv6 Configuration' page with 'RA Guard' selected under 'Mode'. Under 'Interface', 'Port' is selected. Below is a 'Port List' table with 52 total ports. The table has two columns: 'Port' and 'RA Guard'. Port 5 is checked as 'Enabled', while ports 1, 2, 3, and 4 are unchecked.

Port	RA Guard
1	<input type="checkbox"/> Enabled
2	<input type="checkbox"/> Enabled
3	<input type="checkbox"/> Enabled
4	<input type="checkbox"/> Enabled
5	<input checked="" type="checkbox"/> Enabled

CONFIGURING AN IPV6 ADDRESS Use the IP > IPv6 Configuration (Add IPv6 Address) page to configure an IPv6 interface for management access over the network, or for creating an interface to multiple subnets.

CLI REFERENCES

- ◆ ["IPv6 Interface" on page 1432](#)

COMMAND USAGE

- ◆ All IPv6 addresses must be formatted according to RFC 2373 "IPv6 Addressing Architecture," using 8 colon-separated 16-bit hexadecimal values. One double colon may be used in the address to indicate the appropriate number of zeros required to fill the undefined fields.
- ◆ The switch must always be configured with a link-local address. Therefore any configuration process that enables IPv6 functionality, or assigns a global unicast address to the switch, including address auto-configuration or explicitly enabling IPv6 (see ["Configuring IPv6 Interface Settings" on page 644](#)), will also automatically generate a link-local unicast address. The prefix length for a link-local address is fixed at 64 bits, and the host portion of the default address is based on the modified EUI-64 (Extended Universal Identifier) form of the interface identifier (i.e., the physical MAC address). Alternatively, you can manually configure the link-local address by entering the full address with a network prefix in the range of FE80~FEBF.
- ◆ To connect to a larger network with multiple subnets, you must configure a global unicast address. There are several alternatives to configuring this address type:
 - The global unicast address can be automatically configured by taking the network prefix from router advertisements observed on the local interface, and using the modified EUI-64 form of the interface identifier to automatically create the host portion of the address (see ["Configuring IPv6 Interface Settings" on page 644](#)).
 - It can be manually configured by specifying the entire network prefix and prefix length, and using the EUI-64 form of the interface identifier to automatically create the low-order 64 bits in the host portion of the address.
 - You can also manually configure the global unicast address by entering the full address and prefix length.
- ◆ You can configure multiple IPv6 global unicast addresses per interface, but only one link-local address per interface.
- ◆ If a duplicate link-local address is detected on the local segment, this interface is disabled and a warning message displayed on the console. If a duplicate global unicast address is detected on the network, the address is disabled on this interface and a warning message displayed on the console.
- ◆ When an explicit address is assigned to an interface, IPv6 is automatically enabled, and cannot be disabled until all assigned addresses have been removed.

PARAMETERS

These parameters are displayed:

- ◆ **VLAN** – ID of a configured VLAN which is to be used for management access, or for creating an interface to multiple subnets. By default, all ports on the switch are members of VLAN 1. However, the management station can be attached to a port belonging to any VLAN, as long as that VLAN has been assigned an IP address. (Range: 1-4094)
- ◆ **Address Type** – Defines the address type configured for this interface.
 - **Global** – Configures an IPv6 global unicast address with a full IPv6 address including the network prefix and host address bits, followed by a forward slash, and a decimal value indicating how many contiguous bits (from the left) of the address comprise the prefix (i.e., the network portion of the address).
 - **EUI-64** (Extended Universal Identifier) – Configures an IPv6 address for an interface using an EUI-64 interface ID in the low order 64 bits.
 - When using EUI-64 format for the low-order 64 bits in the host portion of the address, the value entered in the IPv6 Address field includes the network portion of the address, and the prefix length indicates how many contiguous bits (starting at the left) of the address comprise the prefix (i.e., the network portion of the address). Note that the value specified in the IPv6 Address field may include some of the high-order host bits if the specified prefix length is less than 64 bits. If the specified prefix length exceeds 64 bits, then the bits used in the network portion of the address will take precedence over the interface identifier.
 - IPv6 addresses are 16 bytes long, of which the bottom 8 bytes typically form a unique host identifier based on the device's MAC address. The EUI-64 specification is designed for devices that use an extended 8-byte MAC address. For devices that still use a 6-byte MAC address (also known as EUI-48 format), it must be converted into EUI-64 format by inverting the universal/local bit in the address and inserting the hexadecimal number FFFE between the upper and lower three bytes of the MAC address.

For example, if a device had an EUI-48 address of 28-9F-18-1C-82-35, the global/local bit must first be inverted to meet EUI-64 requirements (i.e., 1 for globally defined addresses and 0 for locally defined addresses), changing 28 to 2A. Then the two bytes FFFE are inserted between the OUI (i.e., organizationally unique identifier, or company identifier) and the rest of the address, resulting in a modified EUI-64 interface identifier of 2A-9F-18-FF-FE-1C-82-35.
 - This host addressing method allows the same interface identifier to be used on multiple IP interfaces of a single device, as long as those interfaces are attached to different subnets.

- **Link Local** – Configures an IPv6 link-local address.
 - The address prefix must be in the range of FE80~FEBF.
 - You can configure only one link-local address per interface.
 - The specified address replaces a link-local address that was automatically generated for the interface.
- ◆ **IPv6 Address** – IPv6 address assigned to this interface.

WEB INTERFACE

To configure an IPv6 address:

1. Click IP, IPv6 Configuration.
2. Select Add IPv6 Address from the Action list.
3. Specify the VLAN to configure, select the address type, and then enter an IPv6 address and prefix length.
4. Click Apply.

Figure 387: Configuring an IPv6 Address

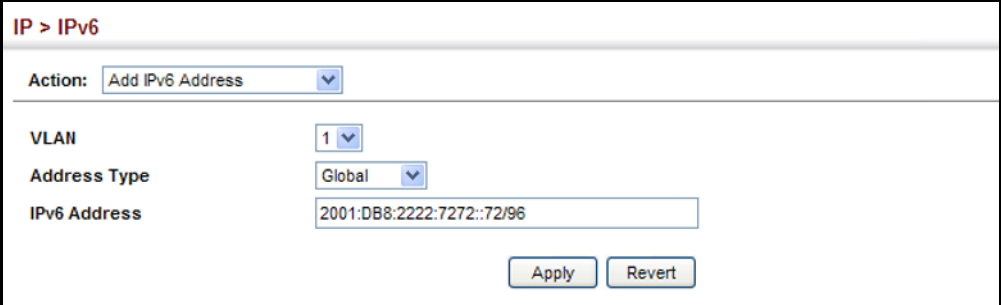

The screenshot shows a web interface for configuring an IPv6 address. At the top, it says "IP > IPv6". Below that, there is a section for "Action:" with a dropdown menu set to "Add IPv6 Address". Underneath, there are three rows of configuration options: "VLAN" with a dropdown set to "1", "Address Type" with a dropdown set to "Global", and "IPv6 Address" with a text input field containing "2001:DB8:2222:7272::72/96". At the bottom right of the form, there are two buttons: "Apply" and "Revert".

SHOWING IPv6 ADDRESSES Use the IP > IPv6 Configuration (Show IPv6 Address) page to display the IPv6 addresses assigned to an interface.

CLI REFERENCES

- ◆ ["show ipv6 interface" on page 1442](#)

PARAMETERS

These parameters are displayed:

- ◆ **VLAN** – ID of a configured VLAN. By default, all ports on the switch are members of VLAN 1. However, the management station can be attached to a port belonging to any VLAN, as long as that VLAN has been assigned an IP address. (Range: 1-4094)
- ◆ **IPv6 Address Type** – The address type (Global, EUI-64, Link Local).
- ◆ **IPv6 Address** – An IPv6 address assigned to this interface.

In addition to the unicast addresses assigned to an interface, a node is also required to listen to the all-nodes multicast addresses FF01::1 (interface-local scope) and FF02::1 (link-local scope).

FF01::1/16 is the transient interface-local multicast address for all attached IPv6 nodes, and FF02::1/16 is the link-local multicast address for all attached IPv6 nodes. The interface-local multicast address is only used for loopback transmission of multicast traffic. Link-local multicast addresses cover the same types as used by link-local unicast addresses, including all nodes (FF02::1), all routers (FF02::2), and solicited nodes (FF02::1:FFXX:XXXX) as described below.

A node is also required to compute and join the associated solicited-node multicast addresses for every unicast and anycast address it is assigned. IPv6 addresses that differ only in the high-order bits, e.g. due to multiple high-order prefixes associated with different aggregations, will map to the same solicited-node address, thereby reducing the number of multicast addresses a node must join. In this example, FF02::1:FF90:0/104 is the solicited-node multicast address which is formed by taking the low-order 24 bits of the address and appending those bits to the prefix.

Note that the solicited-node multicast address (link-local scope FF02) is used to resolve the MAC addresses for neighbor nodes since IPv6 does not support the broadcast method used by the Address Resolution Protocol in IPv4.

These additional addresses are displayed by the CLI (see "[show ip interface](#)" on page 1425).

- ◆ **Configuration Mode** – Indicates if this address was automatically generated or manually configured.

WEB INTERFACE

To show the configured IPv6 addresses:

1. Click IP, IPv6 Configuration.
2. Select Show IPv6 Address from the Action list.
3. Select a VLAN from the list.

Figure 388: Showing Configured IPv6 Addresses

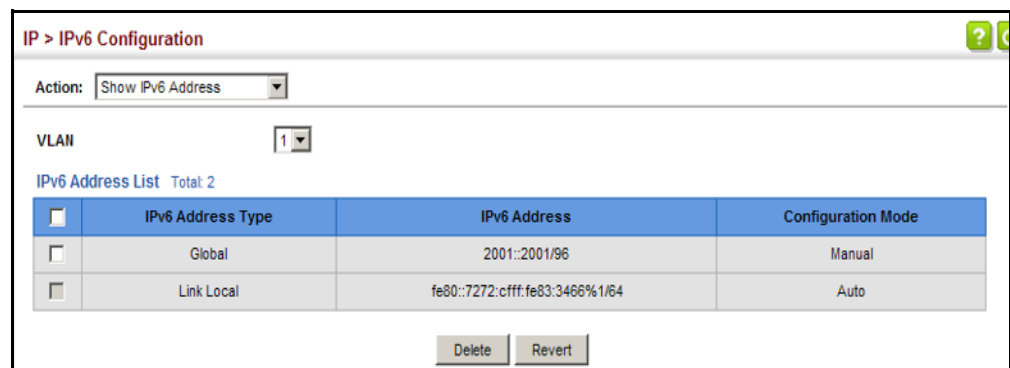

SHOWING THE IPV6 NEIGHBOR CACHE Use the IP > IPv6 Configuration (Show IPv6 Neighbor Cache) page to display the IPv6 addresses detected for neighbor devices.

CLI REFERENCES

- ◆ "show ipv6 neighbors" on page 1457

PARAMETERS

These parameters are displayed:

Table 40: Show IPv6 Neighbors - display description

Field	Description
IPv6 Address	IPv6 address of neighbor
Age	The time since the address was verified as reachable (in seconds). A static entry is indicated by the value "Permanent."
Link-layer Addr	Physical layer MAC address.
State	<p>The following states are used for dynamic entries:</p> <ul style="list-style-type: none">◆ Incomplete - Address resolution is being carried out on the entry. A neighbor solicitation message has been sent to the multicast address of the target, but it has not yet returned a neighbor advertisement message.◆ Invalid - An invalidated mapping. Setting the state to invalid disassociates the interface identified with this entry from the indicated mapping (RFC 4293).◆ Reachable - Positive confirmation was received within the last ReachableTime interval that the forward path to the neighbor was functioning. While in REACH state, the device takes no special action when sending packets.◆ Stale - More than the ReachableTime interval has elapsed since the last positive confirmation was received that the forward path was functioning. While in STALE state, the device takes no action until a packet is sent.◆ Delay - More than the ReachableTime interval has elapsed since the last positive confirmation was received that the forward path was functioning. A packet was sent within the last DELAY_FIRST_PROBE_TIME interval. If no reachability confirmation is received within this interval after entering the DELAY state, the switch will send a neighbor solicitation message and change the state to Probe.◆ Probe - A reachability confirmation is actively sought by re-sending neighbor solicitation messages every RetransTimer interval until confirmation of reachability is received.◆ Unknown - Unknown state. <p>The following states are used for static entries:</p> <ul style="list-style-type: none">◆ Incomplete -The interface for this entry is down.◆ Permanent - Indicates a static entry.◆ Reachable - The interface for this entry is up. Reachability detection is not applied to static entries in the IPv6 neighbor discovery cache.
VLAN	VLAN interface from which the address was reached.

WEB INTERFACE

To show neighboring IPv6 devices:

1. Click IP, IPv6 Configuration.
2. Select Show IPv6 Neighbors from the Action list.

Figure 389: Showing IPv6 Neighbors

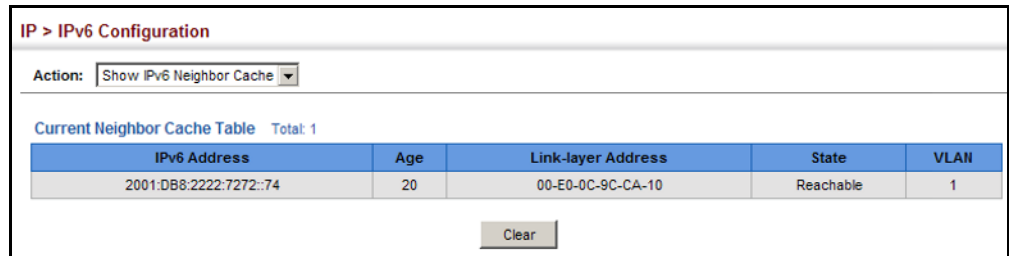

SHOWING IPv6 STATISTICS Use the IP > IPv6 Configuration (Show Statistics) page to display statistics about IPv6 traffic passing through this switch.

CLI REFERENCES

- ◆ "show ipv6 traffic" on page 1445

COMMAND USAGE

This switch provides statistics for the following traffic types:

- ◆ **IPv6** – The Internet Protocol for Version 6 addresses provides a mechanism for transmitting blocks of data (often called packets or frames) from a source to a destination, where these network devices (that is, hosts) are identified by fixed length addresses. The Internet Protocol also provides for fragmentation and reassembly of long packets, if necessary, for transmission through “small packet” networks.
- ◆ **ICMPv6** – Internet Control Message Protocol for Version 6 addresses is a network layer protocol that transmits message packets to report errors in processing IPv6 packets. ICMP is therefore an integral part of the Internet Protocol. ICMP messages may be used to report various situations, such as when a datagram cannot reach its destination, when the gateway does not have the buffering capacity to forward a datagram, and when the gateway can direct the host to send traffic on a shorter route. ICMP is also used by routers to feed back information about more suitable routes (that is, the next hop router) to use for a specific destination.
- ◆ **UDP** – User Datagram Protocol provides a datagram mode of packet switched communications. It uses IP as the underlying transport mechanism, providing access to IP-like services. UDP packets are delivered just like IP packets – connection-less datagrams that may be discarded before reaching their targets. UDP is useful when TCP would be too complex, too slow, or just unnecessary.

PARAMETERS

These parameters are displayed:

Table 41: Show IPv6 Statistics - display description

Field	Description
IPv6 Statistics	
<i>IPv6 Received</i>	
Total	The total number of input datagrams received by the interface, including those received in error.
Header Errors	The number of input datagrams discarded due to errors in their IPv6 headers, including version number mismatch, other format errors, hop count exceeded, IPv6 options, etc.
Too Big Errors	The number of input datagrams that could not be forwarded because their size exceeded the link MTU of outgoing interface.
No Routes	The number of input datagrams discarded because no route could be found to transmit them to their destination.
Address Errors	The number of input datagrams discarded because the IPv6 address in their IPv6 header's destination field was not a valid address to be received at this entity. This count includes invalid addresses (e.g., ::0) and unsupported addresses (e.g., addresses with unallocated prefixes). For entities which are not IPv6 routers and therefore do not forward datagrams, this counter includes datagrams discarded because the destination address was not a local address.
Unknown Protocols	The number of locally-addressed datagrams received successfully but discarded because of an unknown or unsupported protocol. This counter is incremented at the interface to which these datagrams were addressed which might not be necessarily the input interface for some of the datagrams.
Truncated Packets	The number of input datagrams discarded because datagram frame didn't carry enough data.
Discards	The number of input IPv6 datagrams for which no problems were encountered to prevent their continued processing, but which were discarded (e.g., for lack of buffer space). Note that this counter does not include any datagrams discarded while awaiting re-assembly.
Delivers	The total number of datagrams successfully delivered to IPv6 user-protocols (including ICMP). This counter is incremented at the interface to which these datagrams were addressed which might not be necessarily the input interface for some of the datagrams.
Reassembly Request Datagrams	The number of IPv6 fragments received which needed to be reassembled at this interface. Note that this counter is incremented at the interface to which these fragments were addressed which might not be necessarily the input interface for some of the fragments.
Reassembled Succeeded	The number of IPv6 datagrams successfully reassembled. Note that this counter is incremented at the interface to which these datagrams were addressed which might not be necessarily the input interface for some of the fragments.
Reassembled Failed	The number of failures detected by the IPv6 re-assembly algorithm (for whatever reason: timed out, errors, etc.). Note that this is not necessarily a count of discarded IPv6 fragments since some algorithms (notably the algorithm in RFC 815) can lose track of the number of fragments by combining them as they are received. This counter is incremented at the interface to which these fragments were addressed which might not be necessarily the input interface for some of the fragments.

Table 41: Show IPv6 Statistics - display description (Continued)

Field	Description
<i>IPv6 Transmitted</i>	
Forwards Datagrams	The number of output datagrams which this entity received and forwarded to their final destinations. In entities which do not act as IPv6 routers, this counter will include only those packets which were Source-Routed via this entity, and the Source-Route processing was successful. Note that for a successfully forwarded datagram the counter of the outgoing interface is incremented."
Requests	The total number of IPv6 datagrams which local IPv6 user-protocols (including ICMP) supplied to IPv6 in requests for transmission. Note that this counter does not include any datagrams counted in ipv6IfStatsOutForwDatagrams.
Discards	The number of output IPv6 datagrams for which no problem was encountered to prevent their transmission to their destination, but which were discarded (e.g., for lack of buffer space). Note that this counter would include datagrams counted in ipv6IfStatsOutForwDatagrams if any such packets met this (discretionary) discard criterion.
No Routes	The number of input datagrams discarded because no route could be found to transmit them to their destination.
Generated Fragments	The number of output datagram fragments that have been generated as a result of fragmentation at this output interface.
Fragment Succeeded	The number of IPv6 datagrams that have been successfully fragmented at this output interface.
Fragment Failed	The number of IPv6 datagrams that have been discarded because they needed to be fragmented at this output interface but could not be.
ICMPv6 Statistics	
<i>ICMPv6 received</i>	
Input	The total number of ICMP messages received by the interface which includes all those counted by ipv6IfIcmpInErrors. Note that this interface is the interface to which the ICMP messages were addressed which may not be necessarily the input interface for the messages.
Errors	The number of ICMP messages which the interface received but determined as having ICMP-specific errors (bad ICMP checksums, bad length, etc.).
Destination Unreachable Messages	The number of ICMP Destination Unreachable messages received by the interface.
Packet Too Big Messages	The number of ICMP Packet Too Big messages received by the interface.
Time Exceeded Messages	The number of ICMP Time Exceeded messages received by the interface.
Parameter Problem Messages	The number of ICMP Parameter Problem messages received by the interface.
Echo Request Messages	The number of ICMP Echo (request) messages received by the interface.
Echo Reply Messages	The number of ICMP Echo Reply messages received by the interface.
Redirect Messages	The number of Redirect messages received by the interface.
Group Membership Query Messages	The number of ICMPv6 Group Membership Query messages received by the interface.
Group Membership Response Messages	The number of ICMPv6 Group Membership Response messages received by the interface.

Table 41: Show IPv6 Statistics - display description (Continued)

Field	Description
Group Membership Reduction Messages	The number of ICMPv6 Group Membership Reduction messages received by the interface.
Router Solicit Messages	The number of ICMP Router Solicit messages received by the interface.
Router Advertisement Messages	The number of ICMP Router Advertisement messages received by the interface.
Neighbor Solicit Messages	The number of ICMP Neighbor Solicit messages received by the interface.
Neighbor Advertisement Messages	The number of ICMP Neighbor Advertisement messages received by the interface.
Redirect Messages	The number of Redirect messages received by the interface.
<i>ICMPv6 Transmitted</i>	
Output	The total number of ICMP messages which this interface attempted to send. Note that this counter includes all those counted by icmpOutErrors.
Destination Unreachable Messages	The number of ICMP Destination Unreachable messages sent by the interface.
Packet Too Big Messages	The number of ICMP Packet Too Big messages sent by the interface.
Time Exceeded Messages	The number of ICMP Time Exceeded messages sent by the interface.
Parameter Problem Message	The number of ICMP Parameter Problem messages sent by the interface.
Echo Reply Messages	The number of ICMP Echo Reply messages sent by the interface.
Router Solicit Messages	The number of ICMP Router Solicitation messages sent by the interface.
Neighbor Solicit Messages	The number of ICMP Neighbor Solicit messages sent by the interface.
Neighbor Advertisement Messages	The number of ICMP Router Advertisement messages sent by the interface.
Redirect Messages	The number of Redirect messages sent. For a host, this object will always be zero, since hosts do not send redirects.
Group Membership Response Messages	The number of ICMPv6 Group Membership Response messages sent.
Group Membership Reduction Messages	The number of ICMPv6 Group Membership Reduction messages sent.
UDP Statistics	
Input	The total number of UDP datagrams delivered to UDP users.
No Port Errors	The total number of received UDP datagrams for which there was no application at the destination port.
Other Errors	The number of received UDP datagrams that could not be delivered for reasons other than the lack of an application at the destination port.
Output	The total number of UDP datagrams sent from this entity.

WEB INTERFACE

To show the IPv6 statistics:

1. Click IP, IPv6 Configuration.
2. Select Show Statistics from the Action list.
3. Click IPv6, ICMPv6 or UDP.

Figure 390: Showing IPv6 Statistics (IPv6)

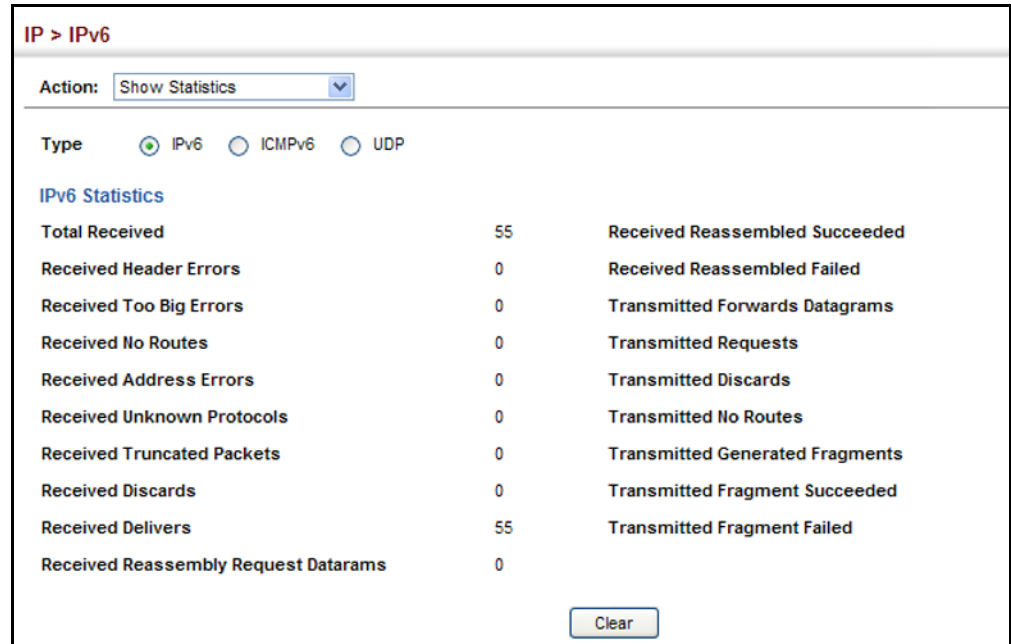

Figure 391: Showing IPv6 Statistics (ICMPv6)

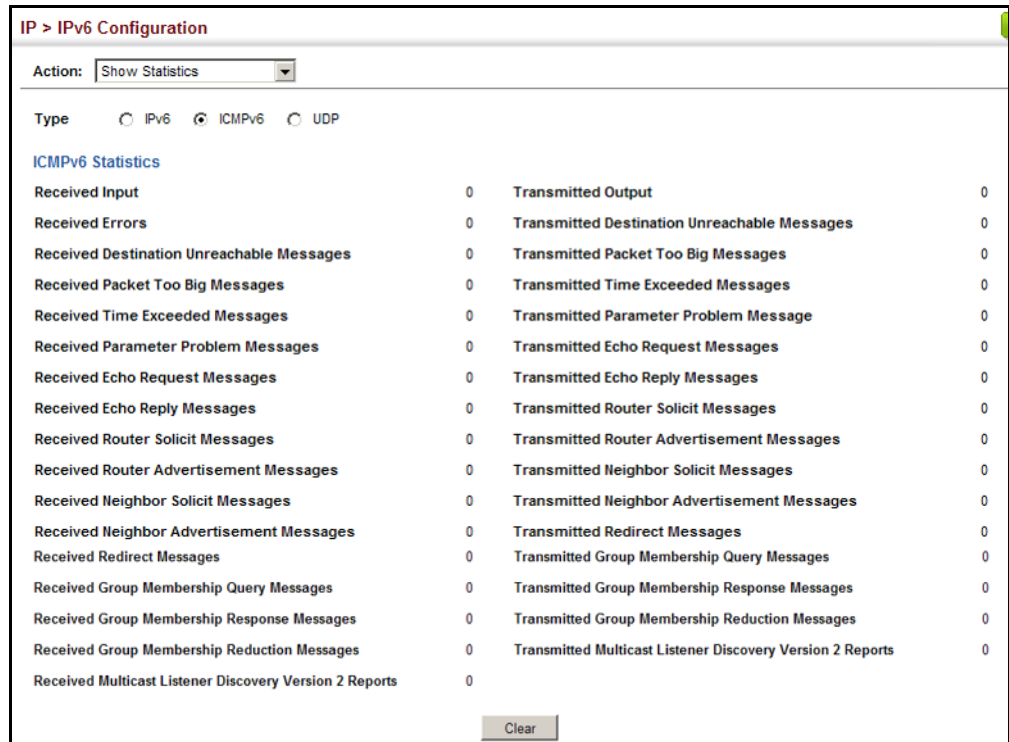
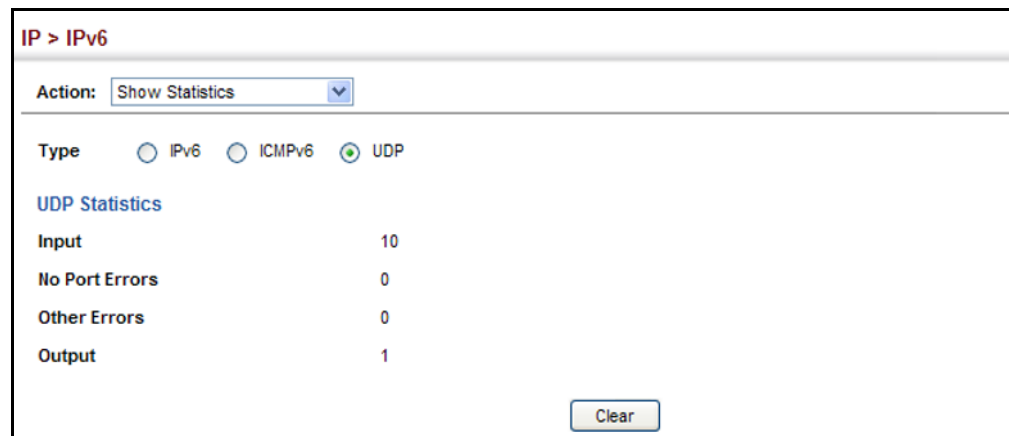

Figure 392: Showing IPv6 Statistics (UDP)



SHOWING THE MTU FOR RESPONDING DESTINATIONS

Use the IP > IPv6 Configuration (Show MTU) page to display the maximum transmission unit (MTU) cache for destinations that have returned an ICMP packet-too-big message along with an acceptable MTU to this switch.

CLI REFERENCES

- ◆ ["show ipv6 mtu" on page 1444](#)

PARAMETERS

These parameters are displayed:

Table 42: Show MTU - display description

Field	Description
MTU	Adjusted MTU contained in the ICMP packet-too-big message returned from this destination, and now used for all traffic sent along this path.
Since	Time since an ICMP packet-too-big message was received from this destination.
Destination Address	Address which sent an ICMP packet-too-big message.

WEB INTERFACE

To show the MTU reported from other devices:

1. Click IP, IPv6 Configuration.
2. Select Show MTU from the Action list.

Figure 393: Showing Reported MTU Values

The screenshot shows the web interface for IP > IPv6 configuration. At the top, there is a breadcrumb 'IP > IPv6'. Below it, an 'Action:' dropdown menu is set to 'Show MTU'. Underneath, there is a section titled 'MTU Table Total: 2' which contains a table with three columns: 'MTU', 'Since', and 'Destination Address'. The table lists two entries: one with MTU 1400 and Since 00:04:21 for destination 5000:1::3, and another with MTU 1280 and Since 00:04:50 for destination FE80::203:A0FF:FED6:141D.

MTU	Since	Destination Address
1400	00:04:21	5000:1::3
1280	00:04:50	FE80::203:A0FF:FED6:141D

This chapter describes how to configure Domain Name Service (DNS) and a DHCP client identifier for the switch. For information on DHCP snooping which is included in this folder, see "[DHCP Snooping](#)" on page 412.

This chapter provides information on the following IP services, including:

- ◆ [DNS](#) – Configures default domain names, identifies servers to use for dynamic lookup, and shows how to configure static entries.
- ◆ [DHCP Client](#) – Specifies the DHCP client identifier for an interface.
- ◆ [DHCP Relay](#) – Enables DHCP relay service, and defines the servers to which client requests are forwarded.
- ◆ [PPPoE Intermediate Agent](#) – Configures PPPoE Intermediate Agent (PPPoE IA) relay parameters required for passing authentication messages between a client and broadband remote access servers.

DOMAIN NAME SERVICE

DNS service on this switch allows host names to be mapped to IP addresses using static table entries or by redirection to other name servers on the network. When a client device designates this switch as a DNS server, the client will attempt to resolve host names into IP addresses by forwarding DNS queries to the switch, and waiting for a response.

You can manually configure entries in the DNS table used for mapping domain names to IP addresses, configure default domain names, or specify one or more name servers to use for domain name to address translation.

CONFIGURING GENERAL DNS SERVICE PARAMETERS

Use the IP Service > DNS - General (Configure Global) page to enable domain lookup and set the default domain name.

CLI REFERENCES

- ◆ "[ip domain-lookup](#)" on page 1402
- ◆ "[ip domain-name](#)" on page 1403

COMMAND USAGE

- ◆ To enable DNS service on this switch, enable domain lookup status, and configure one or more name servers (see "[Configuring a List of Name Servers](#)" on page 666).

PARAMETERS

These parameters are displayed:

- ◆ **Domain Lookup** – Enables DNS host name-to-address translation. (Default: Disabled)
- ◆ **Default Domain Name** – Defines the default domain name appended to incomplete host names. Do not include the initial dot that separates the host name from the domain name. (Range: 1-127 alphanumeric characters)

WEB INTERFACE

To configure general settings for DNS:

1. Click IP Service, DNS.
2. Select Configure Global from the Action list.
3. Enable domain lookup, and set the default domain name.
4. Click Apply.

Figure 394: Configuring General Settings for DNS

The screenshot shows a web interface for configuring DNS settings. At the top, the breadcrumb path is 'IP Service > DNS > General'. Below this, there is an 'Action:' dropdown menu currently set to 'Configure Global'. The main configuration area contains two settings: 'Domain Lookup' with a checked checkbox and the text 'Enabled', and 'Default Domain Name' with a text input field containing 'my.site.com'. At the bottom right of the configuration area, there are two buttons: 'Apply' and 'Revert'.

CONFIGURING A LIST OF DOMAIN NAMES Use the IP Service > DNS - General (Add Domain Name) page to configure a list of domain names to be tried in sequential order.

CLI REFERENCES

- ◆ ["ip domain-list" on page 1401](#)
- ◆ ["show dns" on page 1407](#)

COMMAND USAGE

- ◆ Use this page to define a list of domain names that can be appended to incomplete host names (i.e., host names passed from a client that are not formatted with dotted notation).
- ◆ If there is no domain list, the default domain name is used (see ["Configuring General DNS Service Parameters" on page 663](#)). If there is a domain list, the system will search it for a corresponding entry. If none is found, it will use the default domain name.
- ◆ When an incomplete host name is received by the DNS service on this switch and a domain name list has been specified, the switch will work

through the domain list, appending each domain name in the list to the host name, and checking with the specified name servers for a match (see "Configuring a List of Name Servers" on page 666).

PARAMETERS

These parameters are displayed:

Domain Name – Name of the host. Do not include the initial dot that separates the host name from the domain name. (Range: 1-68 characters)

WEB INTERFACE

To create a list domain names:

1. Click IP Service, DNS.
2. Select Add Domain Name from the Action list.
3. Enter one domain name at a time.
4. Click Apply.

Figure 395: Configuring a List of Domain Names for DNS

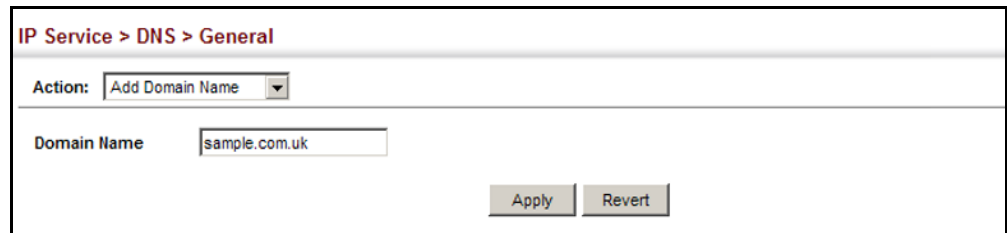

To show the list domain names:

1. Click IP Service, DNS.
2. Select Show Domain Names from the Action list.

Figure 396: Showing the List of Domain Names for DNS

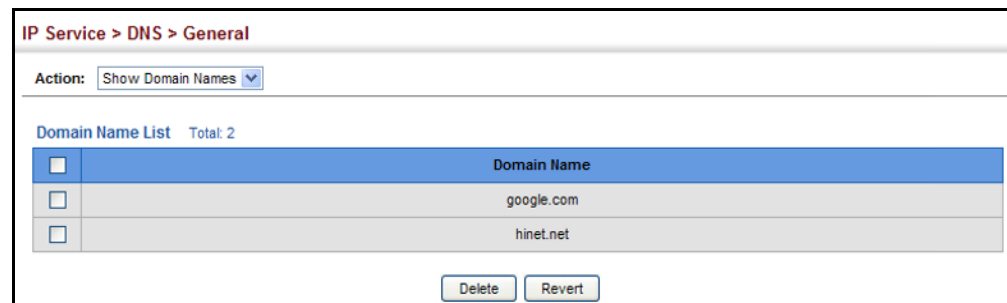

CONFIGURING A LIST OF NAME SERVERS Use the IP Service > DNS - General (Add Name Server) page to configure a list of name servers to be tried in sequential order.

CLI REFERENCES

- ◆ "ip name-server" on page 1405
- ◆ "show dns" on page 1407

COMMAND USAGE

- ◆ To enable DNS service on this switch, configure one or more name servers, and enable domain lookup status (see "Configuring General DNS Service Parameters" on page 663).
- ◆ When more than one name server is specified, the servers are queried in the specified sequence until a response is received, or the end of the list is reached with no response.
- ◆ If all name servers are deleted, DNS will automatically be disabled. This is done by disabling the domain lookup status.

PARAMETERS

These parameters are displayed:

Name Server IP Address – Specifies the IPv4 or IPv6 address of a domain name server to use for name-to-address resolution. Up to six IP addresses can be added to the name server list.

WEB INTERFACE

To create a list name servers:

1. Click IP Service, DNS.
2. Select Add Name Server from the Action list.
3. Enter one name server at a time.
4. Click Apply.

Figure 397: Configuring a List of Name Servers for DNS

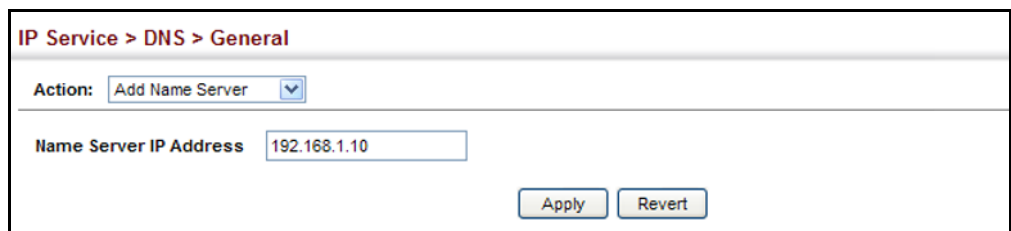

To show the list name servers:

1. Click IP Service, DNS.
2. Select Show Name Servers from the Action list.

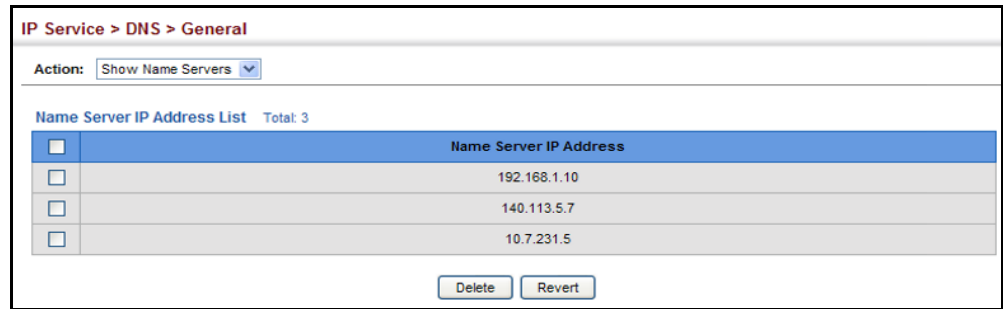
Figure 398: Showing the List of Name Servers for DNS

CONFIGURING STATIC DNS HOST TO ADDRESS ENTRIES

Use the IP Service > DNS - Static Host Table (Add) page to manually configure static entries in the DNS table that are used to map domain names to IP addresses.

CLI REFERENCES

- ◆ ["ip host" on page 1404](#)
- ◆ ["show hosts" on page 1408](#)

COMMAND USAGE

- ◆ Static entries may be used for local devices connected directly to the attached network, or for commonly used resources located elsewhere on the network.

PARAMETERS

These parameters are displayed:

- ◆ **Host Name** – Name of a host device that is mapped to one or more IP addresses. (Range: 1-127 characters)
- ◆ **IP Address** – IPv4 or IPv6 address(es) associated with a host name.

WEB INTERFACE

To configure static entries in the DNS table:

1. Click IP Service, DNS, Static Host Table.
2. Select Add from the Action list.
3. Enter a host name and the corresponding address.
4. Click Apply.

Figure 399: Configuring Static Entries in the DNS Table

IP Service > DNS > Static Host Table

Action: Add

Host Name: yahoo.com

IP Address: 10.2.78.3

Apply Revert

To show static entries in the DNS table:

1. Click IP Service, DNS, Static Host Table.
2. Select Show from the Action list.

Figure 400: Showing Static Entries in the DNS Table

IP Service > DNS > Static Host Table

Action: Show

IP Address List Total: 3

	Host	IP Address
<input type="checkbox"/>	yahoo.com	10.2.78.3
<input type="checkbox"/>	hinet.net	124.29.31.155
<input type="checkbox"/>	google.com	133.45.211.18

Delete Revert

DISPLAYING THE DNS CACHE Use the IP Service > DNS - Cache page to display entries in the DNS cache that have been learned via the designated name servers.

CLI REFERENCES

- ◆ ["show dns cache" on page 1408](#)

COMMAND USAGE

- ◆ Servers or other network devices may support one or more connections via multiple IP addresses. If more than one IP address is associated with a host name via information returned from a name server, a DNS client can try each address in succession, until it establishes a connection with the target device.

PARAMETERS

These parameters are displayed:

- ◆ **No.** – The entry number for each resource record.
- ◆ **Flag** – The flag is always "4" indicating a cache entry and therefore unreliable.

- ◆ **Type** – This field includes CNAME which specifies the host address for the owner, and ALIAS which specifies an alias.
- ◆ **IP** – The IP address associated with this record.
- ◆ **TTL** – The time to live reported by the name server.
- ◆ **Host** – The host name associated with this record.

WEB INTERFACE

To display entries in the DNS cache:

1. Click IP Service, DNS, Cache.

Figure 401: Showing Entries in the DNS Cache

The screenshot shows a web interface titled "IP Service > DNS > Cache". Below the title, it says "Cache Information Total: 3". There is a table with the following data:

No.	Flag	Type	IP	TTL	Host
1	4	CNAME	192.168.110.2	360	www.sina.com.cn
2	4	CNAME	10.2.44.3	892	www.yahoo.akadns.new
3	4	ALIAS	pointer to: 2	298	www.yahoo.com

Below the table is a "Clear" button.

DYNAMIC HOST CONFIGURATION PROTOCOL

Dynamic Host Configuration Protocol (DHCP) can dynamically allocate an IP address and other configuration information to network clients when they boot up. If a subnet does not already include a BOOTP or DHCP server, you can relay DHCP client requests to a DHCP server on another subnet.

**SPECIFYING A
DHCP CLIENT
IDENTIFIER**

Use the IP Service > DHCP > Client page to specify the DHCP client identifier for a VLAN interface.

CLI REFERENCES

- ◆ ["ip dhcp client class-id" on page 1412](#)

COMMAND USAGE

- ◆ The class identifier is used identify the vendor class and configuration of the switch to the DHCP server, which then uses this information to decide on how to service the client or the type of information to return.
- ◆ The general framework for this DHCP option is set out in RFC 2132 (Option 60). This information is used to convey configuration settings or other identification information about a client, but the specific string to use should be supplied by your service provider or network administrator. Options 60, 66 and 67 statements can be added to the server daemon's configuration file.

Table 43: Options 60, 66 and 67 Statements

Option	Keyword	Statement
		Parameter
60	vendor-class-identifier	a string indicating the vendor class identifier
66	tftp-server-name	a string indicating the tftp server name
67	bootfile-name	a string indicating the bootfile name

- ◆ By default, DHCP option 66/67 parameters are not carried in a DHCP server reply. To ask for a DHCP reply with option 66/67 information, the DHCP client request sent by this switch includes a “parameter request list” asking for this information. Besides, the client request also includes a “vendor class identifier” that allows the DHCP server to identify the device, and select the appropriate configuration file for download. This information is included in Option 55 and 124.

Table 44: Options 55 and 124 Statements

Option	Keyword	Statement
		Parameter
55	dhcp-parameter-request-list	a list of parameters, separated by ','
124	vendor-class-identifier	a string indicating the vendor class identifier

- ◆ The server should reply with the TFTP server name and boot file name.
- ◆ Note that the vendor class identifier can be formatted in either text or hexadecimal, but the format used by both the client and server must be the same.

PARAMETERS

These parameters are displayed in the web interface:

- ◆ **VLAN** – ID of configured VLAN.
- ◆ **Vendor Class ID** – The following options are supported when the check box is marked to enable this feature:
 - **Default** – The default string is the unit model number.
 - **Text** – A text string. (Range: 1-32 characters)
 - **Hex** – A hexadecimal value. (Range: 1-64 characters)

WEB INTERFACE

To configure a DHCP client identifier:

1. Click IP Service, DHCP, Client.
2. Mark the check box to enable this feature. Select the default setting, or the format for a vendor class identifier. If a non-default value is used, enter a text string or hexadecimal value.
3. Click Apply.

Figure 402: Specifying a DHCP Client Identifier

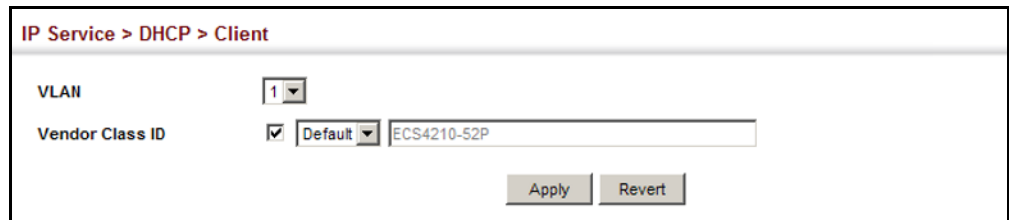

CONFIGURING DHCP RELAY SERVICE

Use the IP Service > DHCP > Relay page to configure DHCP relay service for attached host devices. If DHCP relay is enabled, and this switch sees a DHCP request broadcast, it inserts its own IP address into the request so that the DHCP server will know the subnet where the client is located. Then, the switch forwards the packet to the DHCP server. When the server receives the DHCP request, it allocates a free IP address for the DHCP client from its defined scope for the DHCP client's subnet, and sends a DHCP response back to the DHCP relay agent (i.e., this switch). This switch then passes the DHCP response received from the server to the client.

Figure 403: Layer 2 DHCP Relay Service

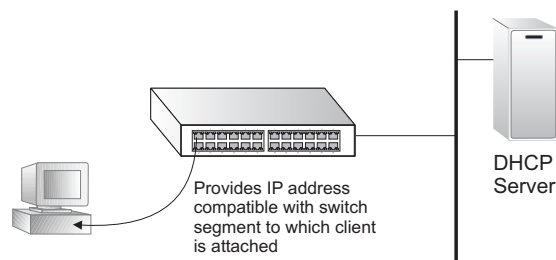

CLI REFERENCES

- ◆ "DHCP Relay" on page 1417

COMMAND USAGE

- ◆ You must specify the IP address for at least one active DHCP server. Otherwise, the switch's DHCP relay agent will not be able to forward client requests to a DHCP server. Up to five DHCP servers can be specified in order of preference.
- ◆ DHCP relay configuration will be disabled if an active DHCP server is detected on the same network segment.

PARAMETERS

These parameters are displayed:

- ◆ **VLAN ID** – ID of configured VLAN.
- ◆ **Server IP Address** – Addresses of DHCP servers or relay servers to be used by the switch's DHCP relay agent in order of preference.
- ◆ **Restart DHCP Relay** – Use this button to re-initialize DHCP relay service.

WEB INTERFACE

To configure DHCP relay service:

1. Click IP Service, DHCP, Relay.
2. Enter up to five IP addresses for DHCP servers or relay servers in order of preference.
3. Click Apply.

Figure 404: Configuring DHCP Relay Service

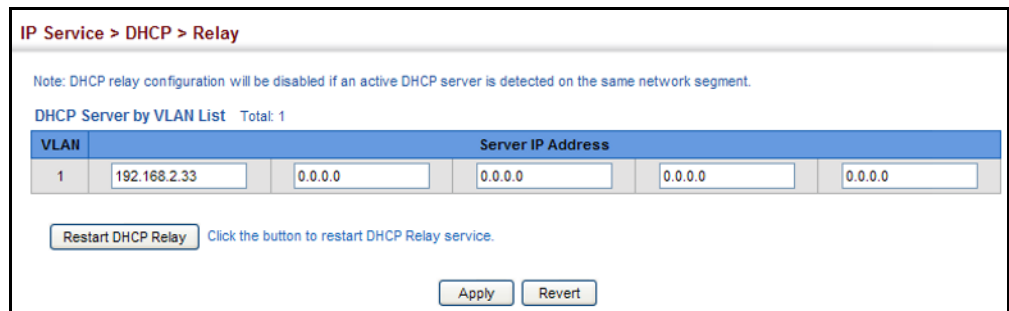

CONFIGURING THE PPPoE INTERMEDIATE AGENT

This section describes how to configure the PPPoE Intermediate Agent (PPPoE IA) relay parameters required for passing authentication messages between a client and broadband remote access servers.

CONFIGURING PPPoE IA GLOBAL SETTINGS

Use the IP Service > PPPoE Intermediate Agent (Configure Global) page to enable the PPPoE IA on the switch, set the access node identifier, and set the generic error message.

CLI REFERENCES

- ◆ "pppoe intermediate-agent" on page 881
- ◆ "pppoe intermediate-agent port-format-type" on page 883
- ◆ "show pppoe intermediate-agent info" on page 885

COMMAND USAGE

When PPPoE IA is enabled, the switch inserts a tag identifying itself as a PPPoE IA residing between the attached client requesting network access and the ports connected to broadband remote access servers (BRAS). The switch extracts access-loop information from the client's PPPoE Active Discovery Request, and forwards this information to all trusted ports (designated on the Configure Interface page). The BRAS detects the presence of the subscriber's circuit-ID tag inserted by the switch during the PPPoE discovery phase, and sends this tag as a NAS-port-ID attribute in PPP authentication and AAA accounting requests to a RADIUS server.

PARAMETERS

These parameters are displayed:

- ◆ **PPPoE IA Global Status** – Enables the PPPoE Intermediate Agent globally on the switch. (Default: Disabled)

Note that PPPoE IA must be enabled globally before it can be enabled on an interface.
- ◆ **Access Node Identifier** – String identifying this switch as an PPPoE IA to the PPPoE server. (Range: 1-48 ASCII characters; Default: IP address of first IPv4 interface on the switch.)

The switch uses the access-node-identifier to generate the circuit-id for PPPoE discovery stage packets sent to the BRAS, but does not modify the source or destination MAC address of these PPPoE discovery packets. These messages are forwarded to all trusted ports designated on the Configure Interface page.
- ◆ **Operational Access Node Identifier** – The configured access node identifier.
- ◆ **Generic Error Message** – An error message notifying the sender that the PPPoE Discovery packet was too large. (Range: 0-127; Default: PPPoE Discover packet too large to process. Try reducing the number of tags added.)
- ◆ **Operational Generic Error Message** – The configured generic error message.

WEB INTERFACE

To configure global settings for PPPoE IA:

1. Click IP Service, PPPoE Intermediate Agent.
2. Select Configure Global from the Step list.
3. Enable the PPPoE IA on the switch, set the access node identifier, and set the generic error message.
4. Click Apply.

Figure 405: Configuring Global Settings for PPPoE Intermediate Agent

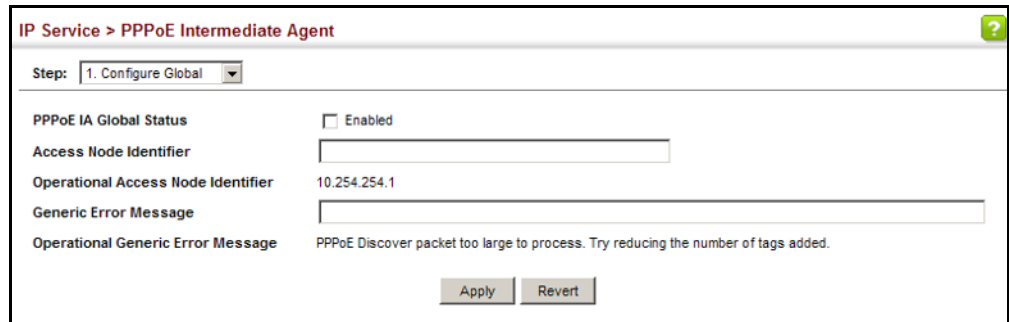

CONFIGURING PPPoE IA INTERFACE SETTINGS

Use the IP Service > PPPoE Intermediate Agent (Configure Interface) page to enable PPPoE IA on an interface, set trust status, enable vendor tag stripping, and set the circuit ID and remote ID.

CLI REFERENCES

- ◆ ["PPPoE Intermediate Agent" on page 880](#)

PARAMETERS

These parameters are displayed:

- ◆ **Interface** – Port or trunk selection.
- ◆ **PPPoE IA Status** – Enables the PPPoE IA on an interface. (Default: Disabled)

Note that PPPoE IA must also be enabled globally on the switch for this command to take effect.
- ◆ **Trust Status** – Sets an interface to trusted mode to indicate that it is connected to a PPPoE server. (Default: Disabled)
 - Set any interfaces connecting the switch to a PPPoE Server as trusted. Interfaces that connect the switch to users (PPPoE clients) should be set as untrusted.
 - At least one trusted interface must be configured on the switch for the PPPoE IA to function.
- ◆ **Vendor Tag Strip** – Enables the stripping of vendor tags from PPPoE Discovery packets sent from a PPPoE server. (Default: Disabled)

This parameter only applies to trusted interfaces. It is used to strip off vendor-specific tags (which carry subscriber and line identification information) in PPPoE Discovery packets received from an upstream PPPoE server before forwarding them to a user.

- ◆ **Circuit ID** – String identifying the circuit identifier (or interface) on this switch to which the user is connected. (Range: 1-10 ASCII characters; Default: Unit/Port:VLAN-ID, or 0/Trunk-ID:VLAN-ID)
 - The PPPoE server extracts the Line-ID tag from PPPoE discovery stage messages, and uses the Circuit-ID field of that tag as a NAS-Port-ID attribute in AAA access and accounting requests.
 - The switch intercepts PPPoE discovery frames from the client and inserts a unique line identifier using the PPPoE Vendor-Specific tag (0x0105) to PPPoE Active Discovery Initiation (PADI) and Request (PADR) packets. The switch then forwards these packets to the PPPoE server. The tag contains the Line-ID of the customer line over which the discovery packet was received, entering the switch (or access node) where the intermediate agent resides.
 - Outgoing PAD Offer (PADO) and Session-confirmation (PADS) packets sent from the PPPoE Server include the Circuit-ID tag inserted by the switch, and should be stripped out of PADO and PADS packets which are to be passed directly to end-node clients.

- ◆ **Operational Circuit ID** – The configured circuit identifier.

- ◆ **Remote ID** – String identifying the remote identifier (or interface) on this switch to which the user is connected. (Range: 1-63 ASCII characters; Default: Port MAC address)

- ◆ **Operational Remote ID** – The configured circuit identifier.

WEB INTERFACE

To configure interface settings for PPPoE IA:

1. Click IP Service, PPPoE Intermediate Agent.
2. Select Configure Interface from the Step list.
3. Select Port or Trunk interface type.
4. Enable PPPoE IA on an interface, set trust status, enable vendor tag stripping if required, and set the circuit ID and remote ID.
5. Click Apply.

Figure 406: Configuring Interface Settings for PPPoE Intermediate Agent

Port	PPPoE IA Status	Trust Status	Vendor Tag Strip	Circuit ID	Operation Circuit ID	Remote ID	Operation Remote ID
1	<input type="checkbox"/> Enabled	<input type="checkbox"/> Enabled	<input type="checkbox"/> Enabled		1/1:vid		B4-0E-DC-34-96-09
2	<input type="checkbox"/> Enabled	<input type="checkbox"/> Enabled	<input type="checkbox"/> Enabled		1/2:vid		B4-0E-DC-34-96-0A
3	<input type="checkbox"/> Enabled	<input type="checkbox"/> Enabled	<input type="checkbox"/> Enabled		1/3:vid		B4-0E-DC-34-96-0B
4	<input type="checkbox"/> Enabled	<input type="checkbox"/> Enabled	<input type="checkbox"/> Enabled		1/4:vid		B4-0E-DC-34-96-0C
5	<input type="checkbox"/> Enabled	<input type="checkbox"/> Enabled	<input type="checkbox"/> Enabled		1/5:vid		B4-0E-DC-34-96-0D

SHOWING PPPoE IA STATISTICS Use the IP Service > PPPoE Intermediate Agent (Show Statistics) page to show statistics on PPPoE IA protocol messages.

CLI REFERENCES

- ◆ "show pppoe intermediate-agent statistics" on page 886
- ◆ "clear pppoe intermediate-agent statistics" on page 885

PARAMETERS

These parameters are displayed:

- ◆ **Interface** – Port or trunk selection.
- ◆ **Received** – Received PPPoE active discovery messages.
 - **All** – All PPPoE active discovery message types.
 - **PADI** – PPPoE Active Discovery Initiation messages.
 - **PADO** – PPPoE Active Discovery Offer messages.
 - **PADR** – PPPoE Active Discovery Request messages.
 - **PADS** – PPPoE Active Discovery Session-Confirmation messages.
 - **PADT** – PPPoE Active Discovery Terminate messages.
- ◆ **Dropped** – Dropped PPPoE active discovery messages.
 - **Response from untrusted** – Response from an interface which not been configured as trusted.
 - **Request towards untrusted** – Request sent to an interface which not been configured as trusted.
 - **Malformed** – Corrupted PPPoE message.

WEB INTERFACE

To show statistics for PPPoE IA protocol messages:

1. Click IP Service, PPPoE Intermediate Agent.
2. Select Show Statistics from the Step list.
3. Select Port or Trunk interface type.

Figure 407: Showing PPPoE Intermediate Agent Statistics

IP Service > PPPoE Intermediate Agent

Step: 3. Show Statistics

Interface Port Trunk

PPPoE Intermediate Agent Statistics Total: 52

Port	Received						Dropped		
	All	PADI	PADO	PADR	PADS	PADT	Response from untrusted	Request towards untrusted	Malformed
1	0	0	0	0	0	0	0	0	0
2	0	0	0	0	0	0	0	0	0
3	0	0	0	0	0	0	0	0	0
4	0	0	0	0	0	0	0	0	0
5	0	0	0	0	0	0	0	0	0

This chapter provides information on network functions including:

- ◆ [Ping](#) – Sends ping message to another node on the network.
- ◆ [Trace Route](#) – Sends ICMP echo request packets to another node on the network.
- ◆ [Address Resolution Protocol](#) – Describes how to configure ARP aging time, proxy ARP, or static addresses. Also shows how to display dynamic entries in the ARP cache.
- ◆ [Static Routes](#) – Configures static routes to other network segments.
- ◆ [Routing Table](#) – Displays routing entries learned through dynamic routing and statically configured entries.

OVERVIEW

This switch supports IP routing and routing path management via static routing definitions. When IP routing is functioning, this switch acts as a wire-speed router, passing traffic between VLANs with different IP interfaces, and routing traffic to external IP networks. However, when the switch is first booted, default routing can only forward traffic between local IP interfaces. As with all traditional routers, static and dynamic routing functions must first be configured to work.

INITIAL CONFIGURATION

By default, all ports belong to the same VLAN and the switch provides only Layer 2 functionality. To segment the attached network, first create VLANs for each unique user group or application traffic ([page 202](#)), assign all ports that belong to the same group to these VLANs ([page 205](#)), and then assign an IP interface to each VLAN ([page 639](#) or [page 643](#)). By separating the network into different VLANs, it can be partitioned into subnetworks that are disconnected at Layer 2. Network traffic within the same subnet is still switched using Layer 2 switching. And the VLANs can now be interconnected (as required) with Layer 3 switching.

Each VLAN represents a virtual interface to Layer 3. You just need to provide the network address for each virtual interface, and the traffic between different subnetworks will be routed by Layer 3 switching.

Figure 408: Virtual Interfaces and Layer 3 Routing

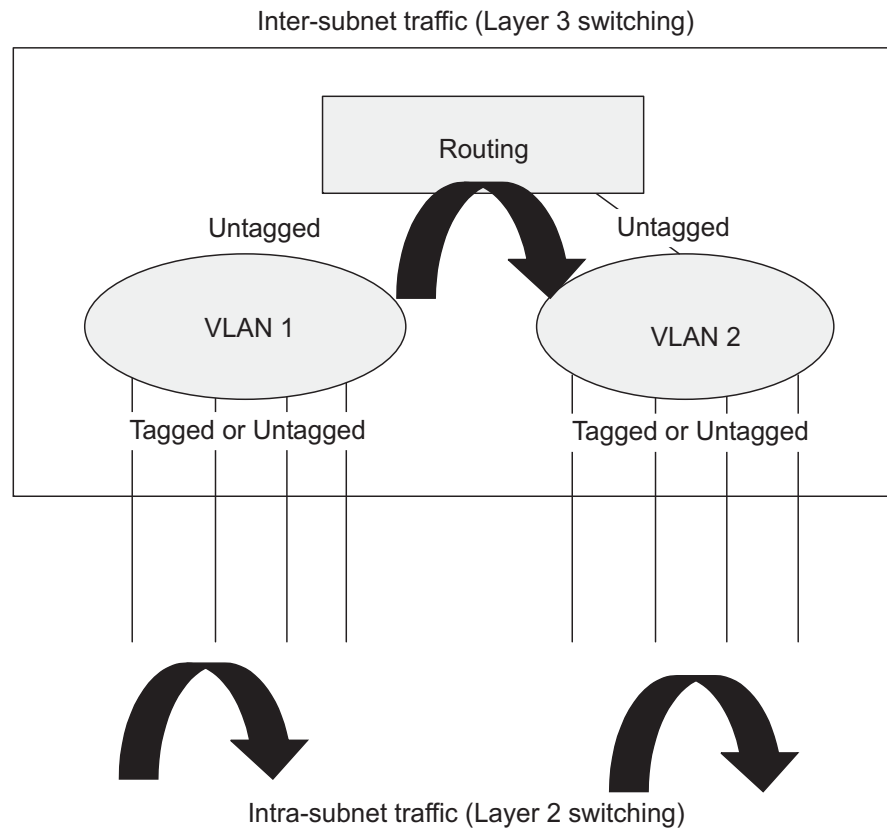

IP ROUTING AND SWITCHING

IP Switching (or packet forwarding) encompasses tasks required to forward packets for both Layer 2 and Layer 3, as well as traditional routing. These functions include:

- ◆ Layer 2 forwarding (switching) based on the Layer 2 destination MAC address
- ◆ Layer 3 forwarding (routing):
 - Based on the Layer 3 destination address
 - Replacing destination/source MAC addresses for each hop
 - Incrementing the hop count
 - Decrementing the time-to-live
 - Verifying and recalculating the Layer 3 checksum

If the destination node is on the same subnetwork as the source network, then the packet can be transmitted directly without the help of a router. However, if the MAC address is not yet known to the switch, an Address Resolution Protocol (ARP) packet with the destination IP address is

broadcast to get the destination MAC address from the destination node. The IP packet can then be sent directly with the destination MAC address.

If the destination belongs to a different subnet on this switch, the packet can be routed directly to the destination node. However, if the packet belongs to a subnet not included on this switch, then the packet should be sent to the next hop router (with the MAC address of the router itself used as the destination MAC address, and the destination IP address of the destination node). The router will then forward the packet to the destination node through the correct path. The router can also use the ARP protocol to find out the MAC address of the destination node of the next router as necessary.



NOTE: In order to perform IP switching, the switch should be recognized by other network nodes as an IP router, either by setting it as the default gateway or by redirection from another router via the ICMP process.

When the switch receives an IP packet addressed to its own MAC address, the packet follows the Layer 3 routing process. The destination IP address is checked against the Layer 3 address table. If the address is not already there, the switch broadcasts an ARP packet to all the ports on the destination VLAN to find out the destination MAC address. After the MAC address is discovered, the packet is reformatted and sent out to the destination. The reformat process includes decreasing the Time-To-Live (TTL) field of the IP header, recalculating the IP header checksum, and replacing the destination MAC address with either the MAC address of the destination node or that of the next hop router.

When another packet destined to the same node arrives, the destination MAC can be retrieved directly from the Layer 3 address table; the packet is then reformatted and sent out the destination port. IP switching can be done at wire-speed when the destination address entry is already in the Layer 3 address table.

If the switch determines that a frame must be routed, the route is calculated only during setup. Once the route has been determined, all packets in the current flow are simply switched or forwarded across the chosen path. This takes advantage of the high throughput and low latency of switching by enabling the traffic to bypass the routing engine once the path calculation has been performed.

ROUTING PATH MANAGEMENT Routing Path Management involves the determination and updating of all the routing information required for packet forwarding, including:

- ◆ Handling routing protocols
- ◆ Updating the routing table
- ◆ Updating the Layer 3 switching database

ROUTING PROTOCOLS The switch supports both static and dynamic routing.

- ◆ Static routing requires routing information to be stored in the switch either manually or when a connection is set up by an application outside the switch.
- ◆ Dynamic routing uses a routing protocol to exchange routing information, calculate routing tables, and respond to changes in the status or loading of the network.

CONFIGURING IP ROUTING INTERFACES

CONFIGURING LOCAL AND REMOTE INTERFACES Use the IP > General > Routing Interface (Configure Interface - Add Address) page to configure routing interfaces for directly connected IPv4 subnets (see ["Setting the Switch's IP Address \(IP Version 4\)" on page 639](#)). Or use the IP > IPv6 Configuration pages to configure routing interfaces for directly connected IPv6 subnets (see ["Setting the Switch's IP Address \(IP Version 6\)" on page 643](#)).

If this router is directly connected to end node devices (or connected to end nodes through shared media) that will be assigned to a specific subnet, then you must create a router interface for each VLAN that will support routing. The router interface consists of an IP address and subnet mask. This interface address defines both the network prefix number to which the router interface is attached and the router's host number on that network. In other words, a router interface address defines the network segment that is connected to that interface, and allows you to send IP packets to or from the router.

You can specify the IP subnets connected directly to this router by manually assigning an IP address to each VLAN, or using BOOTP or DHCP to dynamically assign an address. To specify IP subnets not directly connected to this router, you can either configure static routes (see [page 691](#)).

Once IP interfaces have been configured, the switch functions as a multilayer routing switch, operating at either Layer 2 or 3 as required. All IP packets are routed directly between local interfaces, or indirectly to remote interfaces using either static or dynamic routing. All other packets for non-IP protocols (for example, NetBuei, NetWare or AppleTalk) are switched based on MAC addresses).

To route traffic between remote IP interfaces, the switch should be recognized by other network nodes as an IP router, either by setting it to advertise itself as the default gateway or by redirection from another router via the ICMP process used by various routing protocols.

If the switch is configured to advertise itself as the default gateway, a routing protocol must still be used to determine the next hop router for any unknown destinations, i.e., packets that do not match any routing table

entry. If another router is designated as the default gateway, then the switch will pass packets to this router for any unknown hosts or subnets.

To configure a default gateway for IPv4, use the static routing table as described on [page 691](#), enter 0.0.0.0 for the IP address and subnet mask, and then specify this switch itself or another router as the gateway. To configure a gateway for IPv6, see ["Configuring the IPv6 Default Gateway" on page 643](#).

USING THE PING FUNCTION

Use the IP > General > Ping page to send ICMP echo request packets to another node on the network.

CLI REFERENCES

- ◆ ["ping" on page 1427](#)

PARAMETERS

These parameters are displayed:

- ◆ **Host Name/IP Address** – IPv4/IPv6 address or alias of the host.

For host name-to-IP address translation to function properly, host name lookup must be enabled (["Configuring General DNS Service Parameters" on page 663](#)), and one or more DNS servers specified (see ["Configuring a List of Name Servers" on page 666](#), or ["Configuring Static DNS Host to Address Entries" on page 667](#)).

- ◆ **Probe Count** – Number of packets to send. (Range: 1-16)

- ◆ **Packet Size** – Number of bytes in a packet. (IPv4: 32-512 bytes, IPv6: 0-1500 bytes)

The actual packet size will be eight bytes larger than the size specified because the switch adds header information.

COMMAND USAGE

- ◆ Use the ping command to see if another site on the network can be reached.

- ◆ The following are some results of the **ping** command:

- *Normal response* - The normal response occurs in one to ten seconds, depending on network traffic.
- *Destination does not respond* - If the host does not respond, a "timeout" appears in ten seconds.
- *Destination unreachable* - The gateway for this destination indicates that the destination is unreachable.
- *Network or host unreachable* - The gateway found no corresponding entry in the route table.

- ◆ The same link-local address may be used by different interfaces/nodes in different zones (RFC 4007). Therefore, when specifying a link-local

address, include zone-id information indicating the VLAN identifier after the % delimiter. For example, FE80::7272%1 identifies VLAN 1 as the interface.

WEB INTERFACE

To ping another device on the network:

1. Click IP, General, Ping.
2. Specify the target device and ping parameters.
3. Click Apply.

Figure 409: Pinging a Network Device

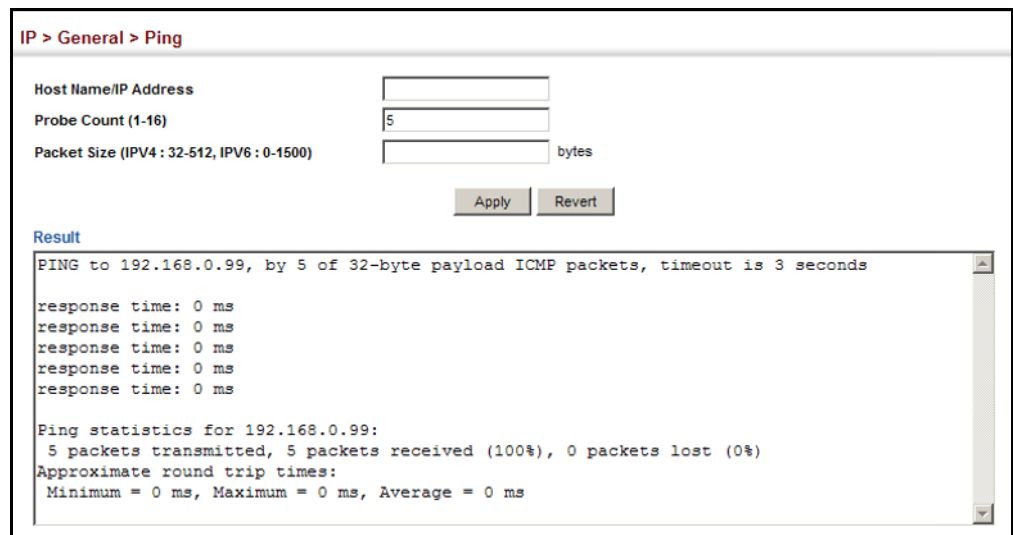

USING THE TRACE ROUTE FUNCTION

Use the IP > General > Trace Route page to show the route packets take to the specified destination.

CLI REFERENCES

- ◆ ["traceroute" on page 1426](#)

PARAMETERS

These parameters are displayed:

- ◆ **Destination IP Address** – IPv4/IPv6 address of the host.
- ◆ **IPv4 Max Failures** – The maximum number of failures before which the trace route is terminated. (Fixed: 5)
- ◆ **IPv6 Max Failures** – The maximum number of failures before which the trace route is terminated. (Range: 1-255; Default: 5)

COMMAND USAGE

- ◆ Use the trace route function to determine the path taken to reach a specified destination.

- ◆ A trace terminates when the destination responds, when the maximum timeout (TTL) is exceeded, or the maximum number of hops is exceeded.
- ◆ The trace route function first sends probe datagrams with the TTL value set at one. This causes the first router to discard the datagram and return an error message. The trace function then sends several probe messages at each subsequent TTL level and displays the round-trip time for each message. Not all devices respond correctly to probes by returning an "ICMP port unreachable" message. If the timer goes off before a response is returned, the trace function prints a series of asterisks and the "Request Timed Out" message. A long sequence of these messages, terminating only when the maximum timeout has been reached, may indicate this problem with the target device.
- ◆ The same link-local address may be used by different interfaces/nodes in different zones (RFC 4007). Therefore, when specifying a link-local address, include zone-id information indicating the VLAN identifier after the % delimiter. For example, FE80::7272%1 identifies VLAN 1 as the interface from which the trace route is sent.

WEB INTERFACE

To trace the route to another device on the network:

1. Click IP, General, Trace Route.
2. Specify the target device.
3. Click Apply.

Figure 410: Tracing the Route to a Network Device

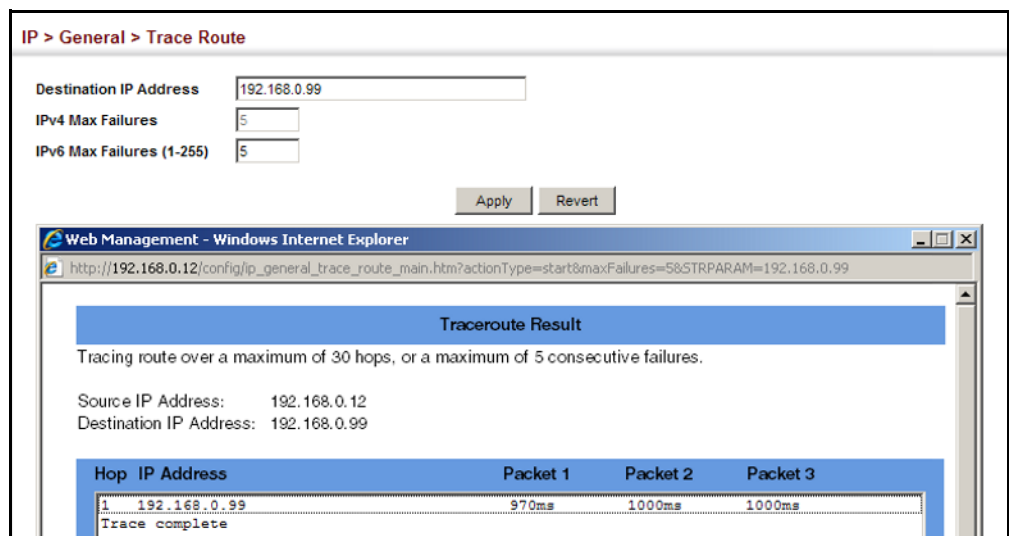

ADDRESS RESOLUTION PROTOCOL

The router uses its routing tables to make routing decisions, and uses Address Resolution Protocol (ARP) to forward traffic from one hop to the next. ARP is used to map an IP address to a physical layer (i.e., MAC) address. When an IP frame is received by this router (or any standards-based router), it first looks up the MAC address corresponding to the destination IP address in the ARP cache. If the address is found, the router writes the MAC address into the appropriate field in the frame header, and forwards the frame on to the next hop. IP traffic passes along the path to its final destination in this way, with each routing device mapping the destination IP address to the MAC address of the next hop toward the recipient, until the packet is delivered to the final destination.

If there is no entry for an IP address in the ARP cache, the router will broadcast an ARP request packet to all devices on the network. The ARP request contains the following fields similar to that shown in this example:

Table 45: Address Resolution Protocol

destination IP address	10.1.0.19
destination MAC address	?
source IP address	10.1.0.253
source MAC address	00-00-ab-cd-00-00

When devices receive this request, they discard it if their address does not match the destination IP address in the message. However, if it does match, they write their own hardware address into the destination MAC address field and send the message back to the source hardware address. When the source device receives a reply, it writes the destination IP address and corresponding MAC address into its cache, and forwards the IP traffic on to the next hop. As long as this entry has not timed out, the router will be able forward traffic directly to the next hop for this destination without having to broadcast another ARP request.

Also, if the switch receives a request for its own IP address, it will send back a response, and also cache the MAC of the source device's IP address.

PROXY ARP CONFIGURATION

Use the IP > ARP (Configure General) page to enable Proxy ARP for specific VLAN interfaces.

CLI REFERENCES

- ◆ ["ip proxy-arp" on page 1430](#)

COMMAND USAGE

When a node in the attached subnetwork does not have routing or a default gateway configured, Proxy ARP can be used to forward ARP requests to a remote subnetwork. When the router receives an ARP request for a remote network and Proxy ARP is enabled, it determines if it has the best route to the remote network, and then answers the ARP request by

sending its own MAC address to the requesting node. That node then sends traffic to the router, which in turn uses its own routing table to forward the traffic to the remote destination.

Figure 411: Proxy ARP

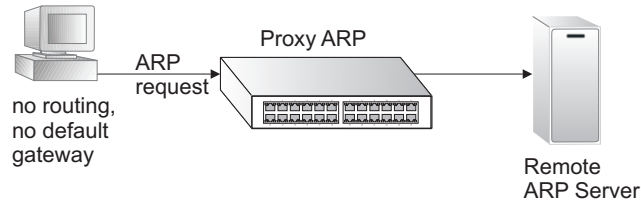

PARAMETERS

These parameters are displayed:

- ◆ **VLAN** – VLAN identifier (Range: 1-4094)
- ◆ **Status** – Enables or disables Proxy ARP for the specified VLAN, allowing a non-routing device to determine the MAC address of a host on another subnet or network. (Default: Disabled)

End stations that require Proxy ARP must view the entire network as a single network. These nodes must therefore use a smaller subnet mask than that used by the router or other relevant network devices.

Extensive use of Proxy ARP can degrade router performance because it may lead to increased ARP traffic and increased search time for larger ARP address tables.

WEB INTERFACE

To enable Proxy ARP for a VLAN (i.e., IP subnetwork):

1. Click IP, ARP.
2. Select Configure General from the Step List.
3. Enable Proxy ARP for subnetworks that do not have routing or a default gateway.
4. Click Apply.

Figure 412: Configuring Proxy ARP

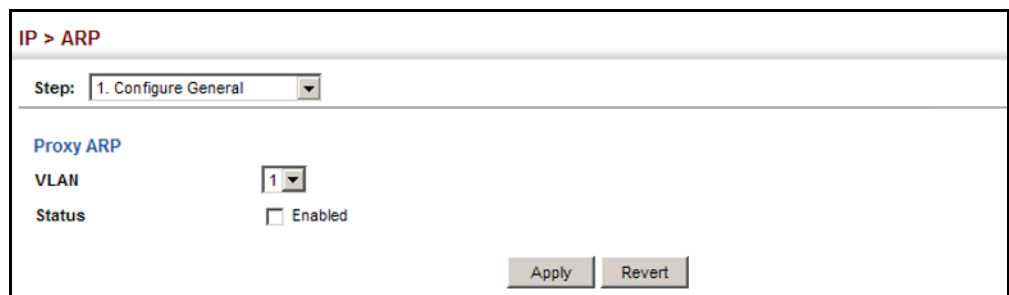

CONFIGURING STATIC ARP ADDRESSES

For devices that do not respond to ARP requests or do not respond in a timely manner, traffic will be dropped because the IP address cannot be mapped to a physical address. If this occurs, use the IP > ARP (Configure Static Address – Add) page to manually map an IP address to the corresponding physical address in the ARP cache.

CLI REFERENCES

- ◆ "arp" on page 1429

COMMAND USAGE

- ◆ The ARP cache is used to map 32-bit IP addresses into 48-bit hardware (that is, Media Access Control) addresses. This cache includes entries for hosts and other routers on local network interfaces defined on this router.
- ◆ You can define up to 32 static entries in the ARP cache.
- ◆ A static entry may need to be used if there is no response to an ARP broadcast message. For example, some applications may not respond to ARP requests or the response arrives too late, causing network operations to time out.
- ◆ Static entries will not be aged out or deleted when power is reset. You can only remove a static entry via the configuration interface.
- ◆ Static entries are only displayed on the Show page for VLANs that are up. In other words, static entries are only displayed when configured for the IP subnet of a configure VLAN, and that VLAN is linked up.

PARAMETERS

These parameters are displayed:

- ◆ **IP Address** – IP address statically mapped to a physical MAC address. (Valid IP addresses consist of four numbers, 0 to 255, separated by periods.)
- ◆ **MAC Address** – MAC address statically mapped to the corresponding IP address. (Valid MAC addresses are hexadecimal numbers in the format: xx-xx-xx-xx-xx-xx)

WEB INTERFACE

To map an IP address to the corresponding physical address in the ARP cache:

1. Click IP, ARP.
2. Select Configure Static Address from the Step List.
3. Select Add from the Action List.
4. Enter the IP address and the corresponding MAC address.
5. Click Apply.

Figure 413: Configuring Static ARP Entries

IP > ARP

Step: 2. Configure Static Address Action: Add

IP Address: 10.2.78.105

MAC Address: 00-e0-0c-00-00-fd

Apply Revert

To display static entries in the ARP cache:

1. Click IP, ARP.
2. Select Configure Static Address from the Step List.
3. Select Show from the Action List.

Figure 414: Displaying Static ARP Entries

IP > ARP

Step: 2. Configure Static Address Action: Show

Static Address List Total: 2

	IP Address	MAC Address	Interface
<input type="checkbox"/>	10.2.78.105	00-E0-0C-00-00-FD	VLAN 1
<input type="checkbox"/>	10.2.78.254	00-12-D9-75-DC-5B	VLAN 1

Delete Revert

DISPLAYING DYNAMIC OR LOCAL ARP ENTRIES

Use the IP > ARP (Show Information) page to display dynamic or local entries in the ARP cache. The ARP cache contains static entries, and entries for local interfaces, including subnet, host, and broadcast addresses. However, most entries will be dynamically learned through replies to broadcast messages.

CLI REFERENCES

- ◆ "show arp" on page 1431

WEB INTERFACE

To display all dynamic entries in the ARP cache:

1. Click IP, ARP.
2. Select Show Information from the Step List.
3. Click Dynamic Address.

Figure 415: Displaying Dynamic ARP Entries

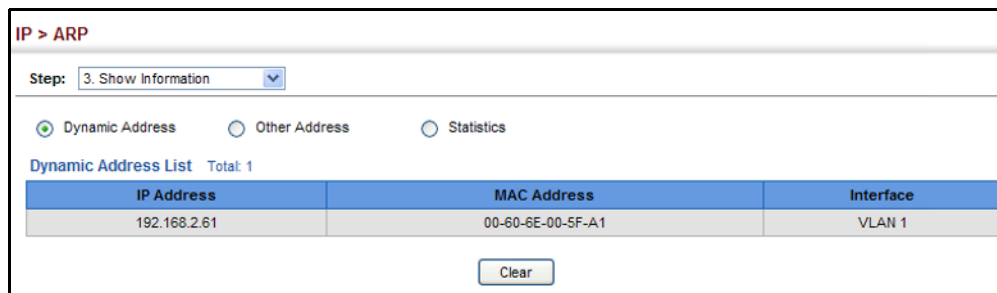

To display all local entries in the ARP cache:

1. Click IP, ARP.
2. Select Show Information from the Step List.
3. Click Other Address.

Figure 416: Displaying Local ARP Entries

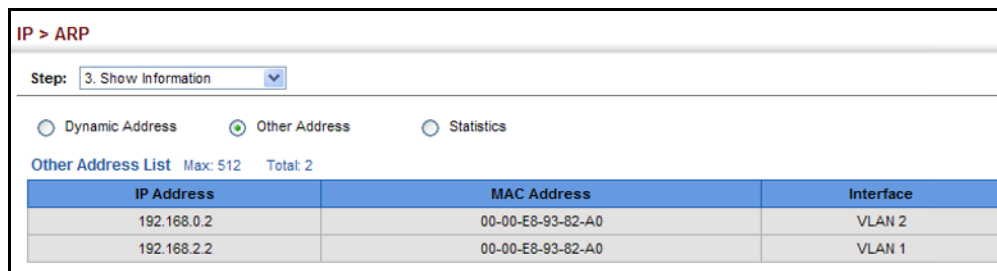

DISPLAYING ARP STATISTICS Use the IP > ARP (Show Information) page to display statistics for ARP messages crossing all interfaces on this router.

CLI REFERENCES

- ◆ ["show ip traffic" on page 1425](#)

PARAMETERS

These parameters are displayed:

Table 46: ARP Statistics

Parameter	Description
Received Request	Number of ARP Request packets received by the router.
Received Reply	Number of ARP Reply packets received by the router.
Sent Request	Number of ARP Request packets sent by the router.
Sent Reply	Number of ARP Reply packets sent by the router.

WEB INTERFACE

To display ARP statistics:

1. Click IP, ARP.
2. Select Show Information from the Step List.
3. Click Statistics.

Figure 417: Displaying ARP Statistics

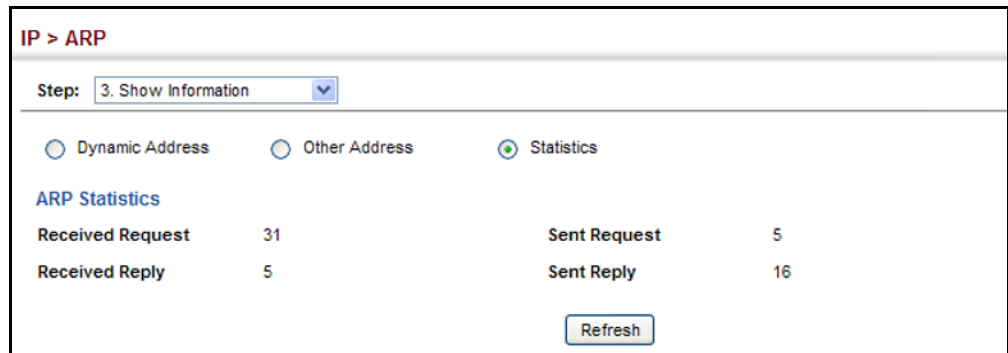

CONFIGURING STATIC ROUTES

This router can configure routes to other network segments by manually entering static routes in the routing table using the IP > Routing > Static Routes (Add) page. Static routes can be set to force the use of a specific route to a subnet. Static routes do not automatically change in response to changes in network topology, so you should only configure a small number of stable routes to ensure network accessibility.

CLI REFERENCES

- ◆ ["ip route" on page 1468](#)
- ◆ ["ip sw-route" on page 1469](#)

COMMAND USAGE

- ◆ Up to 24 static routes can be configured.
- ◆ Due to a hardware limitation on the ECS4110-52T, static routes do not work with DiffServ. Hardware processing of static routes is enabled by default. If you must use DiffServ, then use the [ip sw-route](#) command to configure the switch to process static routes through software.
- ◆ The switch can only process 200~300 routing packets/second. So, it should only be used as L3 switch in this mode for light routing requirements.

PARAMETERS

These parameters are displayed:

- ◆ **Destination IP Address** – IP address of the destination network, subnetwork, or host.
- ◆ **Netmask** – Network mask for the associated IP subnet. This mask identifies the host address bits used for routing to specific subnets.
- ◆ **Next Hop** – IP address of the next router hop used for this route.
- ◆ **Distance** – An administrative distance indicating that this route can be overridden by other routing information. (Range: 1-255, Default: 1)

WEB INTERFACE

To configure static routes:

1. Click IP, Routing, Static Routes.
2. Select Add from the Action List.
3. Enter the destination address, subnet mask, and next hop router.
4. Click Apply.

Figure 418: Configuring Static Routes

IP > Routing > Static Routes	
Action:	Add
Destination IP Address	10.2.48.0
Net Mask / Prefix Length	255.255.255.0
Next Hop	10.2.48.1
Distance (1-255)	5 (Optional)
<input type="button" value="Apply"/> <input type="button" value="Revert"/>	

To display static routes:

1. Click IP, Routing, Static Routes.
2. Select Show from the Action List.

Figure 419: Displaying Static Routes

IP > Routing > Static Routes

Action: Show

Static Table List Total: 3

<input type="checkbox"/>	Destination IP Address	Net Mask / Prefix Length	Next Hop	Distance
<input type="checkbox"/>	10.2.48.2	255.255.255.0	10.2.48.1	5
<input type="checkbox"/>	10.5.36.123	255.255.0.0	10.5.36.1	2
<input type="checkbox"/>	5566::	60	7788::12	1

Buttons: Delete, Revert

DISPLAYING THE ROUTING TABLE

Use the IP > Routing > Routing Table page to display all routes that can be accessed via local network interfaces, through static routes, or through a dynamically learned route. If route information is available through more than one of these methods, the priority for route selection is local, static, and then dynamic (except when the distance parameter of a dynamic route is set to a value that makes its priority exceed that of a static route). Also note that the route for a local interface is not enabled (i.e., listed in the routing table) unless there is at least one active link connected to that interface.

CLI REFERENCES

- ◆ ["show ip route" on page 1469](#)

COMMAND USAGE

- ◆ The Forwarding Information Base (FIB) contains information required to forward IP traffic. It contains the interface identifier and next hop information for each reachable destination network prefix based on the IP routing table. When routing or topology changes occur in the network, the routing table is updated, and those changes are immediately reflected in the FIB.

The FIB is distinct from the routing table (or, Routing Information Base – RIB), which holds all routing information received from routing peers. The FIB contains unique paths only. It does not contain any secondary paths. A FIB entry consists of the minimum amount of information necessary to make a forwarding decision on a particular packet. The typical components within a FIB entry are a network prefix, a router (i.e., VLAN) interface, and next hop information.

- ◆ The Routing Table (and [show ip route](#) command) only displays routes which are currently accessible for forwarding. The router must be able to directly reach the next hop, so the VLAN interface associated with any dynamic or static route entry must be up. Note that routes currently not accessible for forwarding, may still be displayed by using the [show ip route database](#) command.

PARAMETERS

These parameters are displayed:

- ◆ **VLAN** – VLAN identifier (i.e., configured as a valid IP subnet).
- ◆ **Destination IP Address** – IP address of the destination network, subnetwork, or host. Note that the address 0.0.0.0 indicates the default gateway for this router.
- ◆ **Net Mask** – Network mask for the associated IP subnet. This mask identifies the host address bits used for routing to specific subnets.
- ◆ **Next Hop** – The IP address of the next hop (or gateway) in this route.
- ◆ **Metric** – Cost for this interface.
- ◆ **Protocol** – The protocol which generated this route information. (Options: Local, Static, Others)

WEB INTERFACE

To display the routing table:

1. Click IP, Routing, Routing Table.

Figure 420: Displaying the Routing Table

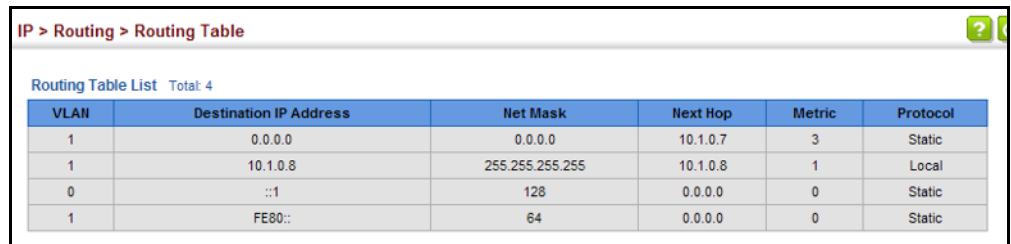

VLAN	Destination IP Address	Net Mask	Next Hop	Metric	Protocol
1	0.0.0.0	0.0.0.0	10.1.0.7	3	Static
1	10.1.0.8	255.255.255.255	10.1.0.8	1	Local
0	::1	128	0.0.0.0	0	Static
1	FE80::	64	0.0.0.0	0	Static

SECTION III

COMMAND LINE INTERFACE

This section provides a detailed description of the Command Line Interface, along with examples for all of the commands.

This section includes these chapters:

- ◆ "General Commands" on page 709
- ◆ "System Management Commands" on page 717
- ◆ "SNMP Commands" on page 793
- ◆ "Remote Monitoring Commands" on page 815
- ◆ "Authentication Commands" on page 823
- ◆ "General Security Measures" on page 889
- ◆ "Access Control Lists" on page 969
- ◆ "Interface Commands" on page 995
- ◆ "Link Aggregation Commands" on page 1021
- ◆ "Power over Ethernet Commands" on page 1035
- ◆ "Port Mirroring Commands" on page 1045
- ◆ "Congestion Control Commands" on page 1055
- ◆ "Loopback Detection Commands" on page 1073
- ◆ "UniDirectional Link Detection Commands" on page 1079
- ◆ "Address Table Commands" on page 1085

- ◆ "Spanning Tree Commands" on page 1091
- ◆ "ERPS Commands" on page 1119
- ◆ "VLAN Commands" on page 1149
- ◆ "Class of Service Commands" on page 1195
- ◆ "Quality of Service Commands" on page 1207
- ◆ "Multicast Filtering Commands" on page 1225
- ◆ "LLDP Commands" on page 1323
- ◆ "CFM Commands" on page 1347
- ◆ "OAM Commands" on page 1389
- ◆ "Domain Name Service Commands" on page 1401
- ◆ "DHCP Commands" on page 1411
- ◆ "IP Interface Commands" on page 1421
- ◆ "IP Routing Commands" on page 1467

This chapter describes how to use the Command Line Interface (CLI).

ACCESSING THE CLI

When accessing the management interface for the switch over a direct connection to the server's console port, or via a Telnet or Secure Shell connection (SSH), the switch can be managed by entering command keywords and parameters at the prompt. Using the switch's command-line interface (CLI) is very similar to entering commands on a UNIX system.

CONSOLE CONNECTION

To access the switch through the console port, perform these steps:

1. At the console prompt, enter the user name and password. (The default user names are "admin" and "guest" with corresponding passwords of "admin" and "guest.") When the administrator user name and password is entered, the CLI displays the "Console#" prompt and enters privileged access mode (i.e., Privileged Exec). But when the guest user name and password is entered, the CLI displays the "Console>" prompt and enters normal access mode (i.e., Normal Exec).
2. Enter the necessary commands to complete your desired tasks.
3. When finished, exit the session with the "quit" or "exit" command.

After connecting to the system through the console port, the login screen displays:

```
User Access Verification
Username: admin
Password:
  CLI session with the ECS4110-52T is opened.
  To end the CLI session, enter [Exit].
Console#
```

TELNET CONNECTION Telnet operates over the IP transport protocol. In this environment, your management station and any network device you want to manage over the network must have a valid IP address. Valid IP addresses consist of four numbers, 0 to 255, separated by periods. Each address consists of a network portion and host portion. For example, the IP address assigned to this switch, 10.1.0.1, consists of a network portion (10.1.0) and a host portion (1).



NOTE: The IP address for this switch is obtained via DHCP by default.

To access the switch through a Telnet session, you must first set the IP address for the Master unit, and set the default gateway if you are managing the switch from a different IP subnet. For example,

```
Console(config)#interface vlan 1
Console(config-if)#ip address 10.1.0.254 255.255.255.0
Console(config-if)#exit
Console(config)#ip default-gateway 10.1.0.254
Console(config)#
```

If your corporate network is connected to another network outside your office or to the Internet, you need to apply for a registered IP address. However, if you are attached to an isolated network, then you can use any IP address that matches the network segment to which you are attached.

After you configure the switch with an IP address, you can open a Telnet session by performing these steps:

1. From the remote host, enter the Telnet command and the IP address of the device you want to access.
2. At the prompt, enter the user name and system password. The CLI will display the "Vty-*n*#" prompt for the administrator to show that you are using privileged access mode (i.e., Privileged Exec), or "Vty-*n*>" for the guest to show that you are using normal access mode (i.e., Normal Exec), where *n* indicates the number of the current Telnet session.
3. Enter the necessary commands to complete your desired tasks.
4. When finished, exit the session with the "quit" or "exit" command.

After entering the Telnet command, the login screen displays:

```
Username: admin
Password:

CLI session with the ECS4110-52T is opened.
To end the CLI session, enter [Exit].

Vty-0#
```



NOTE: You can open up to eight sessions to the device via Telnet or SSH.

ENTERING COMMANDS

This section describes how to enter CLI commands.

KEYWORDS AND ARGUMENTS

A CLI command is a series of keywords and arguments. Keywords identify a command, and arguments specify configuration parameters. For example, in the command “show interfaces status ethernet 1/5,” **show interfaces** and **status** are keywords, **ethernet** is an argument that specifies the interface type, and **1/5** specifies the unit/port.

You can enter commands as follows:

- ◆ To enter a simple command, enter the command keyword.
- ◆ To enter multiple commands, enter each command in the required order. For example, to enable Privileged Exec command mode, and display the startup configuration, enter:

```
Console>enable  
Console#show startup-config
```

- ◆ To enter commands that require parameters, enter the required parameters after the command keyword. For example, to set a password for the administrator, enter:

```
Console(config)#username admin password 0 smith
```

MINIMUM ABBREVIATION

The CLI will accept a minimum number of characters that uniquely identify a command. For example, the command “configure” can be entered as **con**. If an entry is ambiguous, the system will prompt for further input.

COMMAND COMPLETION

If you terminate input with a Tab key, the CLI will print the remaining characters of a partial keyword up to the point of ambiguity. In the “logging history” example, typing **log** followed by a tab will result in printing the command up to “**logging**.”

GETTING HELP ON COMMANDS You can display a brief description of the help system by entering the **help** command. You can also display command syntax by using the “?” character to list keywords or parameters.

SHOWING COMMANDS

If you enter a “?” at the command prompt, the system will display the first level of keywords or command groups. You can also display a list of valid keywords for a specific command. For example, the command “**system ?**” displays a list of possible show commands:

```
Console#show ?
  access-group           Access groups
  access-list            Access lists
  accounting             Uses the specified accounting list
  arp                   Information of ARP cache
  authorization          Enables EXEC accounting
  auto-traffic-control   Auto traffic control information
  banner                 Banner info
  bridge-ext            Bridge extension information
  cable-diagnostics     Shows the information of cable diagnostics
  calendar              Date and time information
  class-map             Displays class maps
  cluster               Display cluster
  collision-mac-address-table Show collision mac address
  debug                State of each debugging option
  discard               Discard packet
  dns                   DNS information
  dos-protection        Shows the system dos-protection summary
                        information
  dot1q-tunnel          dot1q-tunnel
  dot1x                 802.1X content
  efm                   Ethernet First Mile feature
  erps                  Displays ERPS configuration
  ethernet              Shows Metro Ethernet information
  garp                  GARP properties
  gvrp                  GVRP interface information
  history               Shows history information
  hosts                 Host information
  interfaces            Shows interface information
  ip                    IP information
  ipv6                  IPv6 information
  l2protocol-tunnel     Layer 2 protocol tunneling configuration
  lacp                  LACP statistics
  line                  TTY line information
  lldp                  LLDP
  log                   Log records
  logging               Logging setting
  loop                  Shows the information of loopback
  loopback-detection    Shows loopback detection information
  mac                   MAC access list
  mac-address-table     Configuration of the address table
  mac-vlan              MAC-based VLAN information
  management            Shows management information
  memory                Memory utilization
  mvr                   multicast VLAN registration
  mvr6                  IPv6 Multicast VLAN registration
  network-access        Shows the entries of the secure port.
  nlm                   Show notification log
  ntp                   Network Time Protocol configuration
  policy-map            Displays policy maps
  port                  Port characteristics
```

port-channel	Port channel information
power ¹⁸	Shows power
power-save	Shows the power saving information
pppoe	Displays PPPoE configuration
privilege	Shows current privilege level
process	Device process
protocol-vlan	Protocol-VLAN information
public-key	Public key information
qos	Quality of Service
queue	Priority queue information
radius-server	RADIUS server information
reload	Shows the reload settings
rmon	Remote monitoring information
rspan	Display status of the current RSPAN configuration
running-config	Information on the running configuration
snmp	Simple Network Management Protocol config and statistics
snmp-server	Displays SNMP server configuration
sntp	Simple Network Time Protocol configuration
spanning-tree	Spanning-tree configuration
ssh	Secure shell server connections
startup-config	Startup system configuration
subnet-vlan	IP subnet-based VLAN information
system	System information
tacacs-server	TACACS server information
tech-support	Technical information
time-range	Time range
traffic-segmentation	Traffic segmentation information
udld	Displays UDLD information
upgrade	Shows upgrade information
users	Information about users logged in
version	System hardware and software versions
vlan	Shows virtual LAN settings
voice	Shows the voice VLAN information
watchdog	Displays watchdog status
web-auth	Shows web authentication configuration

Console#show

The command “**show interfaces ?**” will display the following information:

```

Console#show interfaces ?
  brief           Shows brief interface description
  counters        Interface counters information
  protocol-vlan   Protocol-VLAN information
  status          Shows interface status
  switchport      Shows interface switchport information
  transceiver     Interface of transceiver information
  transceiver-threshold  Interface of transceiver-threshold information
Console#

```

Show commands which display more than one page of information (e.g., **show running-config**) pause and require you to press the [Space] bar to continue displaying one more page, the [Enter] key to display one more line, or the [a] key to display the rest of the information without stopping. You can press any other key to terminate the display.

18. ES4110-28P/52P

PARTIAL KEYWORD LOOKUP If you terminate a partial keyword with a question mark, alternatives that match the initial letters are provided. (Remember not to leave a space between the command and question mark.) For example “**s?**” shows all the keywords starting with “s.”

```

Console#show s?
snmp          snmp-server    snmp          spanning-tree  ssh
startup-config subnet-vlan    system
Console#show s
    
```

NEGATING THE EFFECT OF COMMANDS For many configuration commands you can enter the prefix keyword “**no**” to cancel the effect of a command or reset the configuration to the default value. For example, the **logging** command will log system messages to a host server. To disable logging, specify the **no logging** command. This guide describes the negation effect for all applicable commands.

USING COMMAND HISTORY The CLI maintains a history of commands that have been entered. You can scroll back through the history of commands by pressing the up arrow key. Any command displayed in the history list can be executed again, or first modified and then executed.

Using the **show history** command displays a longer list of recently executed commands.

UNDERSTANDING COMMAND MODES The command set is divided into Exec and Configuration classes. Exec commands generally display information on system status or clear statistical counters. Configuration commands, on the other hand, modify interface parameters or enable certain switching functions. These classes are further divided into different modes. Available commands depend on the selected mode. You can always enter a question mark “**?**” at the prompt to display a list of the commands available for the current mode. command classes and associated modes are displayed in the following table:

Table 47: General Command Modes

Class	Mode	
Exec	Normal Privileged	
Configuration	Global*	Access Control List CFM Class Map ERPS IGMP Profile Interface Line Multiple Spanning Tree Policy Map Time Range VLAN Database

* You must be in Privileged Exec mode to access the Global configuration mode. You must be in Global Configuration mode to access any other configuration modes.

EXEC COMMANDS When you open a new console session on the switch with the user name and password "guest," the system enters the Normal Exec command mode (or guest mode), displaying the "Console>" command prompt. Only a limited number of the commands are available in this mode. You can access all commands only from the Privileged Exec command mode (or administrator mode). To access Privilege Exec mode, open a new console session with the user name and password "admin." The system will now display the "Console#" command prompt. You can also enter Privileged Exec mode from within Normal Exec mode, by entering the **enable** command, followed by the privileged level password "super."

To enter Privileged Exec mode, enter the following user names and passwords:

```
Username: admin
Password: [admin login password]

CLI session with the ECS4110-52T is opened.
To end the CLI session, enter [Exit].

Console#
```

```
Username: guest
Password: [guest login password]

CLI session with the ECS4110-52T is opened.
To end the CLI session, enter [Exit].

Console>enable
Password: [privileged level password]
Console#
```

CONFIGURATION COMMANDS Configuration commands are privileged level commands used to modify switch settings. These commands modify the running configuration only and are not saved when the switch is rebooted. To store the running configuration in non-volatile storage, use the **copy running-config startup-config** command.

The configuration commands are organized into different modes:

- ◆ Global Configuration - These commands modify the system level configuration, and include commands such as **hostname** and **snmp-server community**.
- ◆ Access Control List Configuration - These commands are used for packet filtering.
- ◆ CFM Configuration - Configures connectivity monitoring using continuity check messages, fault verification through loopback messages, and fault isolation by examining end-to-end connections between Provider Edge devices or between Customer Edge devices.

- ◆ Class Map Configuration - Creates a DiffServ class map for a specified traffic type.
- ◆ ERPS Configuration – These commands configure Ethernet Ring Protection Switching for increased availability of Ethernet rings commonly used in service provider networks.
- ◆ IGMP Profile - Sets a profile group and enters IGMP filter profile configuration mode.
- ◆ Interface Configuration - These commands modify the port configuration such as **speed-duplex** and **negotiation**.
- ◆ Line Configuration - These commands modify the console port and Telnet configuration, and include command such as **parity** and **databits**.
- ◆ Multiple Spanning Tree Configuration - These commands configure settings for the selected multiple spanning tree instance.
- ◆ Policy Map Configuration - Creates a DiffServ policy map for multiple interfaces.
- ◆ Time Range - Sets a time range for use by other functions, such as Access Control Lists.
- ◆ VLAN Configuration - Includes the command to create VLAN groups.

To enter the Global Configuration mode, enter the command **configure** in Privileged Exec mode. The system prompt will change to "Console(config)#" which gives you access privilege to all Global Configuration commands.

```
Console#configure
Console(config)#
```

To enter the other modes, at the configuration prompt type one of the following commands. Use the **exit** or **end** command to return to the Privileged Exec mode.

Table 48: Configuration Command Modes

Mode	Command	Prompt	Page
Line	line {console vty}	Console(config-line)	749
Access Control List	access-list ip standard	Console(config-std-acl)	970
	access-list ip extended	Console(config-ext-acl)	970
	access-list ipv6 standard	Console(config-std-ipv6-acl)	978
	access-list ipv6 extended	Console(config-ext-ipv6-acl)	979
	access-list mac	Console(config-mac-acl)	983
CFM	ethernet cfm domain	Console(config-ether-cfm)	1347
Class Map	class-map	Console(config-cmap)	1208
ERPS	erps domain	Console(config-erps)	1119

Table 48: Configuration Command Modes (Continued)

Mode	Command	Prompt	Page
Interface	interface {ethernet <i>port</i> port-channel <i>id</i> vlan <i>id</i> }	Console(config-if)	996
Line	line {console vty}	Console(config-line)	749
MSTP	spanning-tree mst-configuration	Console(config-mstp)	1098
Policy Map	policy-map	Console(config-pmap)	1211
Time Range	time-range	Console(config-time-range)	783
VLAN	vlan database	Console(config-vlan)	1155

For example, you can use the following commands to enter interface configuration mode, and then return to Privileged Exec mode

```

Console(config)#interface ethernet 1/5
:
:
Console(config-if)#exit
Console(config)#

```

COMMAND LINE PROCESSING

Commands are not case sensitive. You can abbreviate commands and parameters as long as they contain enough letters to differentiate them from any other currently available commands or parameters. You can use the Tab key to complete partial commands, or enter a partial command followed by the "?" character to display a list of possible matches. You can also use the following editing keystrokes for command-line processing:

Table 49: Keystroke Commands

Keystroke	Function
Ctrl-A	Shifts cursor to start of command line.
Ctrl-B	Shifts cursor to the left one character.
Ctrl-C	Terminates the current task and displays the command prompt.
Ctrl-E	Shifts cursor to end of command line.
Ctrl-F	Shifts cursor to the right one character.
Ctrl-K	Deletes all characters from the cursor to the end of the line.
Ctrl-L	Repeats current command line on a new line.
Ctrl-N	Enters the next command line in the history buffer.
Ctrl-P	Enters the last command.
Ctrl-R	Repeats current command line on a new line.
Ctrl-U	Deletes from the cursor to the beginning of the line.
Ctrl-W	Deletes the last word typed.
Esc-B	Moves the cursor back one word.
Esc-D	Deletes from the cursor to the end of the word.

Table 49: Keystroke Commands (Continued)

Keystroke	Function
Esc-F	Moves the cursor forward one word.
Delete key or backspace key	Erases a mistake when entering a command.

OUTPUT MODIFIERS Some of the show commands include options for output modifiers. For example, the “show running-config” command includes the following keyword options:

```
Console#show running-config ?
| Output modifiers
<cr>
```

The output modifiers include options which indicate a string that occurs at the beginning of a line, in lines that are to be excluded, or in lines that are to be included.

```
Console#show running-config | ?
begin      Begin with line that matches
exclude    Exclude lines that match
include    Include lines that match
```

Note that the output modifier `begin` can only be used as the first modifier if more than one modifier is used in a command.

CLI COMMAND GROUPS

The system commands can be broken down into the functional groups shown below.

Table 50: Command Group Index

Command Group	Description	Page
General	Basic commands for entering privileged access mode, restarting the system, or quitting the CLI	709
System Management	Display and setting of system information, basic modes of operation, maximum frame size, file management, console port and telnet settings, system logs, SMTP alerts, the system clock, and switch clustering	717
Simple Network Management Protocol	Activates authentication failure traps; configures community access strings, and trap receivers	793
Remote Monitoring	Supports statistics, history, alarm and event groups	815
User Authentication	Configures user names and passwords, logon access using local or remote authentication, management access through the web server, Telnet server and Secure Shell; as well as port security, IEEE 802.1X port access control, restricted access based on specified IP addresses, and PPPoE Intermediate Agent	823

Table 50: Command Group Index (Continued)

Command Group	Description	Page
General Security Measures	Segregates traffic for clients attached to common data ports; and prevents unauthorized access by configuring valid static or dynamic addresses, web authentication, MAC address authentication, filtering DHCP requests and replies, and discarding invalid ARP responses	889
Access Control List	Provides filtering for IPv4 frames (based on address, protocol, TCP/UDP port number or TCP control code), IPv6 frames (based on address, DSCP traffic class, or next header), or non-IP frames (based on MAC address or Ethernet type)	969
Interface	Configures the connection parameters for all Ethernet ports, aggregated links, and VLANs	995
Link Aggregation	Statically groups multiple ports into a single logical trunk; configures Link Aggregation Control Protocol for port trunks	1021
Power over Ethernet*	Configures power output for connected devices	1035
Mirror Port	Mirrors data to another port for analysis without affecting the data passing through or the performance of the monitored port	1045
Congestion Control	Sets the input/output rate limits, traffic storm thresholds, and thresholds for broadcast and multicast storms which can be used to trigger configured rate limits or to shut down a port.	1055
Address Table	Configures the address table for filtering specified addresses, displays current entries, clears the table, or sets the aging time	1085
Spanning Tree	Configures Spanning Tree settings for the switch	1091
ERPS	Configures Ethernet Ring Protection Switching for increased availability of Ethernet rings commonly used in service provider networks	1119
VLANs	Configures VLAN settings, and defines port membership for VLAN groups; also enables or configures private VLANs, protocol VLANs, voice VLANs, and QinQ tunneling	1149
Class of Service	Sets port priority for untagged frames, selects strict priority or weighted round robin, relative weight for each priority queue, also sets priority for DSCP	1195
Quality of Service	Configures Differentiated Services	1207
Multicast Filtering	Configures IGMP multicast filtering, query, profile, and proxy parameters; specifies ports attached to a multicast router; also configures multicast VLAN registration, and IPv6 MLD snooping	1225
Link Layer Discovery Protocol	Configures LLDP settings to enable information discovery about neighbor devices	1323
Connectivity Fault Management	Configures connectivity monitoring using continuity check messages, fault verification through loopback messages, and fault isolation by examining end-to-end connections between Provider Edge devices or between Customer Edge devices	1347
OAM	Configures Operations, Administration and Maintenance remote management tools required to monitor and maintain the links to subscriber CPEs	1389
Domain Name Service	Configures DNS services.	1401
Dynamic Host Configuration Protocol	Configures DHCP client functions	1411

Table 50: Command Group Index (Continued)

Command Group	Description	Page
IP Interface	Configures IP address for the switch interfaces; also configures ARP parameters and static entries	1421
IP Routing	Configures static unicast routing	1467
Debug	Displays debugging information for all key functions These commands are not described in this manual. Please refer to the prompt messages included in the CLI interface.	

* ES4110-28P/52P

The access mode shown in the following tables is indicated by these abbreviations:

- ACL** (Access Control List Configuration)
- CM** (Class Map Configuration)
- GC** (Global Configuration)
- IC** (Interface Configuration)
- IPC** (IGMP Profile Configuration)
- LC** (Line Configuration)
- MST** (Multiple Spanning Tree)
- NE** (Normal Exec)
- PE** (Privileged Exec)
- PM** (Policy Map Configuration)
- VC** (VLAN Database Configuration)

The general commands are used to control the command access mode, configuration mode, and other basic functions.

Table 51: General Commands

Command	Function	Mode
<code>prompt</code>	Customizes the CLI prompt	GC
<code>reload</code>	Restarts the system at a specified time, after a specified delay, or at a periodic interval	GC
<code>enable</code>	Activates privileged mode	NE
<code>quit</code>	Exits a CLI session	NE, PE
<code>show history</code>	Shows the command history buffer	NE, PE
<code>configure</code>	Activates global configuration mode	PE
<code>disable</code>	Returns to normal mode from privileged mode	PE
<code>reload</code>	Restarts the system immediately	PE
<code>show reload</code>	Displays the current reload settings, and the time at which next scheduled reload will take place	PE
<code>end</code>	Returns to Privileged Exec mode	any config. mode
<code>exit</code>	Returns to the previous configuration mode, or exits the CLI	any mode
<code>help</code>	Shows how to use help	any mode
<code>?</code>	Shows options for command completion (context sensitive)	any mode

prompt This command customizes the CLI prompt. Use the **no** form to restore the default prompt.

SYNTAX

prompt *string*

no prompt

string - Any alphanumeric string to use for the CLI prompt.
(Maximum length: 255 characters)

DEFAULT SETTING

Console

COMMAND MODE

Global Configuration

COMMAND USAGE

This command and the `hostname` command can be used to set the command line prompt as shown in the example below. Using the **no** form of either command will restore the default command line prompt.

EXAMPLE

```
Console(config)#prompt RD2
RD2(config)#
```

reload
(Global Configuration)

This command restarts the system at a specified time, after a specified delay, or at a periodic interval. You can reboot the system immediately, or you can configure the switch to reset after a specified amount of time. Use the **cancel** option to remove a configured setting.

SYNTAX

```
reload {at hour minute [{month day | day month} [year]] |
in {hour hours | minute minutes | hour hours minute minutes} |
regularity hour minute [period {daily | weekly day-of-week |
monthly day}] | cancel [at | in | regularity]}
```

reload at - A specified time at which to reload the switch.

hour - The hour at which to reload. (Range: 0-23)

minute - The minute at which to reload. (Range: 0-59)

month - The month at which to reload. (january ... december)

day - The day of the month at which to reload. (Range: 1-31)

year - The year at which to reload. (Range: 1970-2037)

reload in - An interval after which to reload the switch.

hours - The number of hours, combined with the minutes, before the switch resets. (Range: 0-576)

minutes - The number of minutes, combined with the hours, before the switch resets. (Range: 0-59)

reload regularity - A periodic interval at which to reload the switch.

hour - The hour at which to reload. (Range: 0-23)

minute - The minute at which to reload. (Range: 0-59)

day-of-week - Day of the week at which to reload. (Range: monday ... saturday)

day - Day of the month at which to reload. (Range: 1-31)

reload cancel - Cancels the specified reload option.

DEFAULT SETTING

None

COMMAND MODE

Global Configuration

COMMAND USAGE

- ◆ This command resets the entire system.
- ◆ Any combination of reload options may be specified. If the same option is re-specified, the previous setting will be overwritten.
- ◆ When the system is restarted, it will always run the Power-On Self-Test. It will also retain all configuration information stored in non-volatile memory by the [copy running-config startup-config](#) command (See ["copy" on page 738](#)).

EXAMPLE

This example shows how to reset the switch after 30 minutes:

```

Console(config)#reload in minute 30
***
*** --- Rebooting at January  1 02:10:43 2007 ---
***

Are you sure to reboot the system at the specified time? <y/n>

```

enable This command activates Privileged Exec mode. In privileged mode, additional commands are available, and certain commands display additional information. See ["Understanding Command Modes" on page 702](#).

SYNTAX**enable** [*level*]*level* - Privilege level to log into the device.

The device has two predefined privilege levels: 0: Normal Exec, 15: Privileged Exec. Enter level 15 to access Privileged Exec mode.

DEFAULT SETTING

Level 15

COMMAND MODE

Normal Exec

COMMAND USAGE

- ◆ "super" is the default password required to change the command mode from Normal Exec to Privileged Exec. (To set this password, see the [enable password](#) command.)
- ◆ The "#" character is appended to the end of the prompt to indicate that the system is in privileged access mode.

EXAMPLE

```

Console>enable
Password: [privileged level password]
Console#

```

RELATED COMMANDS[disable \(714\)](#)[enable password \(824\)](#)

quit This command exits the configuration program.

DEFAULT SETTING

None

COMMAND MODE

Normal Exec, Privileged Exec

COMMAND USAGE

The **quit** and **exit** commands can both exit the configuration program.

EXAMPLE

This example shows how to quit a CLI session:

```

Console#quit

Press ENTER to start session

User Access Verification

Username:

```

show history This command shows the contents of the command history buffer.

DEFAULT SETTING

None

COMMAND MODE

Normal Exec, Privileged Exec

COMMAND USAGE

The history buffer size is fixed at 10 Execution commands and 10 Configuration commands.

EXAMPLE

In this example, the show history command lists the contents of the command history buffer:

```

Console#show history
Execution command history:
 2 config
 1 show history

Configuration command history:
 4 interface vlan 1
 3 exit
 2 interface vlan 1
 1 end

Console#

```

The **!** command repeats commands from the Execution command history buffer when you are in Normal Exec or Privileged Exec Mode, and commands from the Configuration command history buffer when you are in any of the configuration modes. In this example, the **!2** command repeats the second command in the Execution history buffer (**config**).

```

Console#!2
Console#config
Console(config)#

```

configure This command activates Global Configuration mode. You must enter this mode to modify any settings on the switch. You must also enter Global Configuration mode prior to enabling some of the other configuration modes, such as Interface Configuration, Line Configuration, and VLAN Database Configuration. See ["Understanding Command Modes" on page 702](#).

DEFAULT SETTING

None

COMMAND MODE

Privileged Exec

EXAMPLE

```

Console#configure
Console(config)#

```

RELATED COMMANDS

[end \(715\)](#)

disable This command returns to Normal Exec mode from privileged mode. In normal access mode, you can only display basic information on the switch's configuration or Ethernet statistics. To gain access to all commands, you must use the privileged mode. See ["Understanding Command Modes" on page 702](#).

DEFAULT SETTING

None

COMMAND MODE

Privileged Exec

COMMAND USAGE

The ">" character is appended to the end of the prompt to indicate that the system is in normal access mode.

EXAMPLE

```
Console#disable
Console>
```

RELATED COMMANDS

[enable \(711\)](#)

reload (Privileged Exec) This command restarts the system.



NOTE: When the system is restarted, it will always run the Power-On Self-Test. It will also retain all configuration information stored in non-volatile memory by the copy running-config startup-config command.

DEFAULT SETTING

None

COMMAND MODE

Privileged Exec

COMMAND USAGE

This command resets the entire system.

EXAMPLE

This example shows how to reset the switch:

```
Console#reload
System will be restarted, continue <y/n>? y
```

show reload This command displays the current reload settings, and the time at which next scheduled reload will take place.

COMMAND MODE

Privileged Exec

EXAMPLE

```
Console#show reload
Reloading switch in time:                0 hours 29 minutes.

The switch will be rebooted at January  1 02:11:50 2001.
Remaining Time: 0 days, 0 hours, 29 minutes, 52 seconds.
Console#
```

end This command returns to Privileged Exec mode.

DEFAULT SETTING

None

COMMAND MODE

Global Configuration, Interface Configuration, Line Configuration, VLAN Database Configuration, and Multiple Spanning Tree Configuration.

EXAMPLE

This example shows how to return to the Privileged Exec mode from the Interface Configuration mode:

```
Console(config-if)#end
Console#
```

exit This command returns to the previous configuration mode or exits the configuration program.

DEFAULT SETTING

None

COMMAND MODE

Any

EXAMPLE

This example shows how to return to the Privileged Exec mode from the Global Configuration mode, and then quit the CLI session:

```
Console(config)#exit  
Console#exit
```

Press ENTER to start session

User Access Verification

Username:

The system management commands are used to control system logs, passwords, user names, management options, and display or configure a variety of other system information.

Table 52: System Management Commands

Command Group	Function
Device Designation	Configures information that uniquely identifies this switch
Banner Information	Configures administrative contact, device identification and location
System Status	Displays system configuration, active managers, and version information
Frame Size	Enables support for jumbo frames
File Management	Manages code image or switch configuration files
Line	Sets communication parameters for the serial port, including baud rate and console time-out
Event Logging	Controls logging of error messages
SMTP Alerts	Configures SMTP email alerts
Time (System Clock)	Sets the system clock automatically via NTP/SNTP server or manually
Time Range	Sets a time range for use by other functions, such as Access Control Lists
Switch Clustering	Configures management of multiple devices via a single IP address

DEVICE DESIGNATION

This section describes commands used to configure information that uniquely identifies the switch.

Table 53: Device Designation Commands

Command	Function	Mode
hostname	Specifies the host name for the switch	GC
snmp-server contact	Sets the system contact string	GC
snmp-server location	Sets the system location string	GC

hostname This command specifies or modifies the host name for this device. Use the **no** form to restore the default host name.

SYNTAX

hostname *name*

no hostname

name - The name of this host. (Maximum length: 255 characters)

DEFAULT SETTING

None

COMMAND MODE

Global Configuration

EXAMPLE

```
Console(config)#hostname RD#1  
Console(config)#
```

BANNER INFORMATION

These commands are used to configure and manage administrative information about the switch, its exact data center location, details of the electrical and network circuits that supply the switch, as well as contact information for the network administrator and system manager. This information is only available via the CLI and is automatically displayed before login as soon as a console or telnet connection has been established.

Table 54: Banner Commands

Command	Function	Mode
banner configure	Configures the banner information that is displayed before login	GC
banner configure company	Configures the Company information that is displayed by banner	GC
banner configure dc-power-info	Configures the DC Power information that is displayed by banner	GC
banner configure department	Configures the Department information that is displayed by banner	GC
banner configure equipment-info	Configures the Equipment information that is displayed by banner	GC
banner configure equipment-location	Configures the Equipment Location information that is displayed by banner	GC
banner configure ip-lan	Configures the IP and LAN information that is displayed by banner	GC
banner configure lp-number	Configures the LP Number information that is displayed by banner	GC

Table 54: Banner Commands (Continued)

Command	Function	Mode
<code>banner configure manager-info</code>	Configures the Manager contact information that is displayed by banner	GC
<code>banner configure mux</code>	Configures the MUX information that is displayed by banner	GC
<code>banner configure note</code>	Configures miscellaneous information that is displayed by banner under the Notes heading	GC
<code>show banner</code>	Displays all banner information	NE, PE

banner configure This command is used to interactively specify administrative information for this device.

SYNTAX

```
banner configure
```

DEFAULT SETTING

None

COMMAND MODE

Global Configuration

COMMAND USAGE

The administrator can batch-input all details for the switch with one command. When the administrator finishes typing the company name and presses the enter key, the script prompts for the next piece of information, and so on, until all information has been entered. Pressing enter without inputting information at any prompt during the script's operation will leave the field empty. Spaces can be used during script mode because pressing the enter key signifies the end of data input. The delete and left-arrow keys terminate the script. The use of the backspace key during script mode is not supported. If, for example, a mistake is made in the company name, it can be corrected with the **banner configure company** command.

EXAMPLE

```
Console(config)#banner configure

Company: EdgeCore Networks
Responsible department: R&D Dept
Name and telephone to Contact the management people
Manager1 name: Sr. Network Admin
  phone number: 123-555-1212
Manager2 name: Jr. Network Admin
  phone number: 123-555-1213
Manager3 name: Night-shift Net Admin / Janitor
  phone number: 123-555-1214
The physical location of the equipment.
City and street address: 12 Straight St. Motown, Zimbabwe
Information about this equipment:
Manufacturer: EdgeCore Networks
ID: 123_unique_id_number
Floor: 2
```

```
Row: 7  
Rack: 29  
Shelf in this rack: 8  
Information about DC power supply.  
Floor: 2  
Row: 7  
Rack: 25  
Electrical circuit: : ec-177743209-xb  
Number of LP:12  
Position of the equipment in the MUX:1/23  
IP LAN:192.168.1.1  
Note: This is a random note about this managed switch and can contain  
miscellaneous information.  
Console(config)#
```

banner configure company This command is used to configure company information displayed in the banner. Use the **no** form to remove the company name from the banner display.

SYNTAX

banner configure company *name*

no banner configure company

name - The name of the company.
(Maximum length: 32 characters)

DEFAULT SETTING

None

COMMAND MODE

Global Configuration

COMMAND USAGE

Input strings cannot contain spaces. The **banner configure company** command interprets spaces as data input boundaries. The use of underscores (`_`) or other unobtrusive non-letter characters is suggested for situations where white space is necessary for clarity.

EXAMPLE

```
Console(config)#banner configure company EdgeCore  
Console(config)#
```

banner configure dc-power-info This command is use to configure DC power information displayed in the banner. Use the **no** form to restore the default setting.

SYNTAX

banner configure dc-power-info floor *floor-id* **row** *row-id*
rack *rack-id* **electrical-circuit** *ec-id*

no banner configure dc-power-info [**floor** | **row** | **rack** |
electrical-circuit]

floor-id - The floor number.

row-id - The row number.

rack-id - The rack number.

ec-id - The electrical circuit ID.

Maximum length of each parameter: 32 characters

DEFAULT SETTING

None

COMMAND MODE

Global Configuration

COMMAND USAGE

Input strings cannot contain spaces. The **banner configure dc-power-info** command interprets spaces as data input boundaries. The use of underscores (`_`) or other unobtrusive non-letter characters is suggested for situations where white space is necessary for clarity.

EXAMPLE

```
Console(config)#banner configure dc-power-info floor 3 row 15 rack 24
    electrical-circuit 48v-id_3.15.24.2
Console(config)#
```

banner configure department This command is used to configure the department information displayed in the banner. Use the **no** form to restore the default setting.

SYNTAX

banner configure department *dept-name*

no banner configure department

dept-name - The name of the department.
(Maximum length: 32 characters)

DEFAULT SETTING

None

COMMAND MODE

Global Configuration

COMMAND USAGE

Input strings cannot contain spaces. The **banner configure department** command interprets spaces as data input boundaries. The use of underscores (`_`) or other unobtrusive non-letter characters is suggested for situations where white space is necessary for clarity.

EXAMPLE

```
Console(config)#banner configure department R&D
Console(config)#
```

banner configure equipment-info This command is used to configure the equipment information displayed in the banner. Use the **no** form to restore the default setting.

SYNTAX

```
banner configure equipment-info manufacturer-id mfr-id  
floor floor-id row row-id rack rack-id shelf-rack sr-id  
manufacturer mfr-name
```

```
no banner configure equipment-info [floor | manufacturer |  
manufacturer-id | rack | row | shelf-rack]
```

mfr-id - The name of the device model number.

floor-id - The floor number.

row-id - The row number.

rack-id - The rack number.

sr-id - The shelf number in the rack.

mfr-name - The name of the device manufacturer.

Maximum length of each parameter: 32 characters

DEFAULT SETTING

None

COMMAND MODE

Global Configuration

COMMAND USAGE

Input strings cannot contain spaces. The **banner configure equipment-info** command interprets spaces as data input boundaries. The use of underscores (`_`) or other unobtrusive non-letter characters is suggested for situations where white space is necessary for clarity.

EXAMPLE

```
Console(config)#banner configure equipment-info manufacturer-id ECS4110-52T
  floor 3 row 10 rack 15 shelf-rack 12 manufacturer EdgeCore
Console(config)#
```

banner configure equipment-location This command is used to configure the equipment location information displayed in the banner. Use the **no** form to restore the default setting.

SYNTAX

banner configure equipment-location *location*

no banner configure equipment-location

location - The address location of the device.
(Maximum length: 32 characters)

DEFAULT SETTING

None

COMMAND MODE

Global Configuration

COMMAND USAGE

Input strings cannot contain spaces. The **banner configure equipment-location** command interprets spaces as data input boundaries. The use of underscores (`_`) or other unobtrusive non-letter characters is suggested for situations where white space is necessary for clarity.

EXAMPLE

```
Console(config)#banner configure equipment-location
  710_Network_Path,_Indianapolis
Console(config)#
```

banner configure ip-lan This command is used to configure the device IP address and subnet mask information displayed in the banner. Use the **no** form to restore the default setting.

SYNTAX

banner configure ip-lan *ip-mask*

no banner configure ip-lan

ip-mask - The IP address and subnet mask of the device.
(Maximum length: 32 characters)

DEFAULT SETTING

None

COMMAND MODE

Global Configuration

COMMAND USAGE

Input strings cannot contain spaces. The **banner configure ip-lan** command interprets spaces as data input boundaries. The use of underscores (`_`) or other unobtrusive non-letter characters is suggested for situations where white space is necessary for clarity.

EXAMPLE

```
Console(config)#banner configure ip-lan 192.168.1.1/255.255.255.0  
Console(config)#
```

banner configure ip-number This command is used to configure the LP number information displayed in the banner. Use the **no** form to restore the default setting.

SYNTAX

banner configure ip-number *lp-num*

no banner configure ip-number

lp-num - The LP number. (Maximum length: 32 characters)

DEFAULT SETTING

None

COMMAND MODE

Global Configuration

COMMAND USAGE

Input strings cannot contain spaces. The **banner configure ip-number** command interprets spaces as data input boundaries. The use of underscores (`_`) or other unobtrusive non-letter characters is suggested for situations where white space is necessary for clarity.

EXAMPLE

```
Console(config)#banner configure lp-number 12  
Console(config)#
```

banner configure manager-info This command is used to configure the manager contact information displayed in the banner. Use the **no** form to restore the default setting.

SYNTAX

```
banner configure manager-info
  name mgr1-name phone-number mgr1-number
  [name2 mgr2-name phone-number mgr2-number |
  name3 mgr3-name phone-number mgr3-number]
no banner configure manager-info [name1 | name2 | name3]
```

mgr1-name - The name of the first manager.

mgr1-number - The phone number of the first manager.

mgr2-name - The name of the second manager.

mgr2-number - The phone number of the second manager.

mgr3-name - The name of the third manager.

mgr3-number - The phone number of the third manager.

Maximum length of each parameter: 32 characters

DEFAULT SETTING

None

COMMAND MODE

Global Configuration

COMMAND USAGE

Input strings cannot contain spaces. The **banner configure manager-info** command interprets spaces as data input boundaries. The use of underscores (`_`) or other unobtrusive non-letter characters is suggested for situations where white space is necessary for clarity.

EXAMPLE

```
Console(config)#banner configure manager-info name Albert_Einstein phone-
number 123-555-1212 name2 Lamar phone-number 123-555-1219
Console(config)#
```

banner configure mux This command is used to configure the mux information displayed in the banner. Use the **no** form to restore the default setting.

SYNTAX

```
banner configure mux muxinfo
no banner configure mux
```

muxinfo - The circuit and PVC to which the switch is connected.
(Maximum length: 32 characters)

DEFAULT SETTING

None

COMMAND MODE

Global Configuration

COMMAND USAGE

Input strings cannot contain spaces. The **banner configure mux** command interprets spaces as data input boundaries. The use of underscores (`_`) or other unobtrusive non-letter characters is suggested for situations where white space is necessary for clarity.

EXAMPLE

```
Console(config)#banner configure mux telco-8734212kx_PVC-1/23
Console(config)#
```

banner configure note This command is used to configure the note displayed in the banner. Use the **no** form to restore the default setting.

SYNTAX

banner configure note *note-info*

no banner configure note

note-info - Miscellaneous information that does not fit the other banner categories, or any other information of importance to users of the switch CLI. (Maximum length: 150 characters)

DEFAULT SETTING

None

COMMAND MODE

Global Configuration

COMMAND USAGE

Input strings cannot contain spaces. The **banner configure note** command interprets spaces as data input boundaries. The use of underscores (`_`) or other unobtrusive non-letter characters is suggested for situations where white space is necessary for clarity.

EXAMPLE

```
Console(config)#banner configure note !!!!!ROUTINE_MAINTENANCE_firmware-
upgrade_0100-0500_GMT-0500_20071022!!!!!!_20min_network_impact_expected
Console(config)#
```

show banner This command displays all banner information.

COMMAND MODE

Normal Exec, Privileged Exec

EXAMPLE

```

Console#show banner
EdgeCore
WARNING - MONITORED ACTIONS AND ACCESSES
R&D

Albert_Einstein - 123-555-1212
Lamar - 123-555-1219

Station's information:
710_Network_Path,_Indianapolis

EdgeCore - ECS4110-52T
Floor / Row / Rack / Sub-Rack
3/ 10 / 15 / 12
DC power supply:
Power Source A: Floor / Row / Rack / Electrical circuit
3/ 15 / 24 / 48v-id_3.15.24.2
Number of LP: 12
Position MUX: telco-8734212kx_PVC-1/23
IP LAN: 192.168.1.1/255.255.255.0
Note: !!!!!ROUTINE_MAINTENANCE_firmware-upgrade_0100-0500_GMT-
0500_20071022!!!!!!_20min_network_
Console#

```

SYSTEM STATUS

This section describes commands used to display system information.

Table 55: System Status Commands

Command	Function	Mode
show access-list tcam-utilization	Shows utilization parameters for TCAM	PE
show memory	Shows memory utilization parameters	NE, PE
show process cpu	Shows CPU utilization parameters	NE, PE
show running-config	Displays the configuration data currently in use	PE
show startup-config	Displays the contents of the configuration file (stored in flash memory) that is used to start up the system	PE
show system	Displays system information	NE, PE
show tech-support	Displays a detailed list of system settings designed to help technical support resolve configuration or functional problems	PE
show users	Shows all active console and Telnet sessions, including user name, idle time, and IP address of Telnet clients	NE, PE
show version	Displays version information for the system	NE, PE

Table 55: System Status Commands (Continued)

Command	Function	Mode
<code>show watchdog</code>	Shows if watchdog debugging is enabled	PE
<code>watchdog software</code>	Monitors key processes, and automatically reboots the system if any of these processes are not responding correctly	PE

show access-list tcam-utilization This command shows utilization parameters for TCAM (Ternary Content Addressable Memory), including the number policy control entries in use, the number of free entries, and the overall percentage of TCAM in use.

COMMAND MODE
Privileged Exec

COMMAND USAGE

Policy control entries (PCEs) are used by various system functions which rely on rule-based searches, including Access Control Lists (ACLs), IP Source Guard filter rules, Quality of Service (QoS) processes, or traps.

For example, when binding an ACL to a port, each rule in an ACL will use two PCEs; and when setting an IP Source Guard filter rule for a port, the system will also use two PCEs.

EXAMPLE

```

Console#show access-list tcam-utilization
  Total Policy Control Entries : 768
  Free Policy Control Entries  : 756
  Entries Used by System      : 12
  Entries Used by User        : 0
  TCAM Utilization            : 1.56%
Console#
    
```

show memory This command shows memory utilization parameters.

COMMAND MODE
Normal Exec, Privileged Exec

COMMAND USAGE

This command shows the amount of memory currently free for use, the amount of memory allocated to active processes, the total amount of system memory, and the alarm thresholds.

EXAMPLE

```

Console#show memory
  Status Bytes      %
  -----
Free      18800640   14
Used      115417088  86
Total     134217728
    
```

```
Alarm Configuration
Rising Threshold      : 95%
Falling Threshold     : 90%
```

```
Console#
```

RELATED COMMANDS

[memory \(813\)](#)

show process cpu This command shows the CPU utilization parameters, alarm status, and alarm thresholds.

COMMAND MODE
Normal Exec, Privileged Exec

EXAMPLE

```
Console#show process cpu
CPU Utilization in the past 5 seconds : 39%

CPU Utilization in the past 60 seconds
Average Utilization      : 36%
Maximum Utilization      : 39%

Alarm Status
Current Alarm Status     : Off
Last Alarm Start Time    : Dec 28 11:20:01 2013
Last Alarm Duration Time : 13 seconds

Alarm Configuration
Rising Threshold         : 90%
Falling Threshold        : 70%

Console#
```

RELATED COMMANDS

[process cpu \(814\)](#)

show running-config This command displays the configuration information currently in use.

SYNTAX

show running-config [**interface** *interface*]

interface

ethernet *unit/port*

unit - Unit identifier. (Range: 1)

port - Port number. (Range: 1-28/52)

port-channel *channel-id* (Range: 1-16)

vlan *vlan-id* (Range: 1-4094)

COMMAND MODE

Privileged Exec

COMMAND USAGE

- ◆ Use the **interface** keyword to display configuration data for the specified interface.
- ◆ Use this command in conjunction with the **show startup-config** command to compare the information in running memory to the information stored in non-volatile memory.
- ◆ This command displays settings for key command modes. Each mode group is separated by "!" symbols, and includes the configuration mode command, and corresponding commands. This command displays the following information:
 - MAC address for the switch
 - SNMP community strings
 - Users (names, access levels, and encrypted passwords)
 - VLAN database (VLAN ID, name and state)
 - VLAN configuration settings for each interface
 - Multiple spanning tree instances (name and interfaces)
 - IP address configured for management VLAN
 - Interface settings
 - Any configured settings for the console port and Telnet

EXAMPLE

```
Console#show running-config
Building startup configuration. Please wait...
!<stackingDB>00</stackingDB>
!<stackingMac>01_00-e0-0c-00-00-fd_00</stackingMac>
!
snmp-server community public ro
snmp-server community private rw
!
snmp-server enable traps authentication
!
username admin access-level 15
username admin password 7 21232f297a57a5a743894a0e4a801fc3
username guest access-level 0
username guest password 7 084e0343a0486ff05530df6c705c8bb4
enable password level 15 7 1b3231655cebb7a1f783eddf27d254ca
!
vlan database
VLAN 1 name DefaultVlan media ethernet state active
!
spanning-tree mst configuration
!
interface ethernet 1/1
switchport allowed vlan add 1 untagged
switchport native vlan 1

.
.
.
!
interface vlan 1
ip address 192.168.1.10 255.255.255.0
!
```

```
queue mode strict-wrr 0 0 0 1
queue weight 1 2 4 0

!
line console
!
line vty
!
end
!
Console#
```

RELATED COMMANDS

[show startup-config \(731\)](#)

show startup-config This command displays the configuration file stored in non-volatile memory that is used to start up the system.

COMMAND MODE

Privileged Exec

COMMAND USAGE

- ◆ Use this command in conjunction with the **show running-config** command to compare the information in running memory to the information stored in non-volatile memory.
- ◆ This command displays settings for key command modes. Each mode group is separated by “!” symbols, and includes the configuration mode command, and corresponding commands. This command displays the following information:
 - MAC address for the switch
 - SNMP community strings
 - SNMP trap authentication
 - Users (names and access levels)
 - VLAN database (VLAN ID, name and state)
 - Multiple spanning tree instances (name and interfaces)
 - Interface settings and VLAN configuration settings for each interface
 - IP address for management VLAN
 - Any configured settings for the console port and Telnet

EXAMPLE

Refer to the example for the running configuration file.

RELATED COMMANDS

[show running-config \(729\)](#)

show system This command displays system information.

DEFAULT SETTING

None

COMMAND MODE

Normal Exec, Privileged Exec

COMMAND USAGE

- ◆ For a description of the items shown by this command, refer to ["Displaying System Information" on page 123](#).
- ◆ The ECS4110-28T/P has two fans and ECS4110-52T/P has three.
- ◆ The ECS4110-28T/P does not monitor system temperature.

EXAMPLE

```
Console#show system
System Description : ECS4110-52T Managed GE Switch
System OID String : 1.3.6.1.4.1.259.10.1.39.101
System Information
  System Up Time      : 0 days, 7 hours, 20 minutes, and 43.30 seconds
  System Name         :
  System Location     :
  System Contact      :
  MAC Address (Unit 1) : 00-E0-0C-00-00-FD
  Web Server          : Enabled
  Web Server Port     : 80
  Web Secure Server   : Enabled
  Web Secure Server Port : 443
  Telnet Server       : Enabled
  Telnet Server Port  : 23
  Jumbo Frame         : Disabled

Unit 1
  Fan 1: Ok           Fan 2: Ok           Fan 3: Ok

System Temperature:
Unit 1
  Temperature 1: 48 degrees

Console#
```

show tech-support This command displays a detailed list of system settings designed to help technical support resolve configuration or functional problems.

COMMAND MODE

Normal Exec, Privileged Exec

COMMAND USAGE

This command generates a long list of information including detailed system and interface settings. It is therefore advisable to direct the output to a file using any suitable output capture function provided with your terminal emulation program.

EXAMPLE

```

Console#show tech-support

show system:
System Description : ECS4110-52T Managed GE Switch
System OID String  : 1.3.6.1.4.1.259.10.1.39.101
System Information
System Up Time      : 0 days, 1 hours, 28 minutes, and 51.70 seconds
System Name        :
System Location     :
System Contact      :
MAC Address (Unit 1) : 00-E0-0C-00-00-FD
Web Server          : Enabled
Web Server Port     : 80
Web Secure Server   : Disabled
Web Secure Server Port : 443
Telnet Server       : Enabled
Telnet Server Port  : 23
Jumbo Frame         : Disabled
:

```

show users Shows all active console and Telnet sessions, including user name, idle time, and IP address of Telnet client.

DEFAULT SETTING

None

COMMAND MODE

Normal Exec, Privileged Exec

COMMAND USAGE

The session used to execute this command is indicated by a "*" symbol next to the Line (i.e., session) index number.

EXAMPLE

```

Console#show users
User Name Accounts:
User Name Privilege Public-Key
-----
admin          15 None
guest          0 None
steve          15 RSA

Line      User Name      Idle time (h:m:s)  Remote IP addr
-----
*console  admin          0:00:01
VTY 0     admin          0:00:00  192.168.1.19
SSH 1     steve          0:00:06  192.168.1.19

Web Online Users:
Line      User Name      Idle time (h:m:s)  Remote IP addr
-----
HTTP     admin          0:00:00  192.168.0.99
Console#

```

show version This command displays hardware and software version information for the system.

COMMAND MODE

Normal Exec, Privileged Exec

COMMAND USAGE

See ["Displaying Hardware/Software Versions" on page 125](#) for detailed information on the items displayed by this command.

EXAMPLE

```
Console#show version
Serial Number       : S123456
Hardware Version    : R0A
EPLD Version        : 0.00
Number of Ports     : 52
Main Power Status   : Up
Role                : Master
Loader Version      : 0.0.0.1
Linux Kernel Version : 2.6.22.18
Boot ROM Version    : 0.0.0.1
Operation Code Version : 0.0.1.4

Console#
```

show watchdog This command shows if watchdog debugging is enabled.

COMMAND MODE

Privileged Exec

EXAMPLE

```
Console#show watchdog

Software Watchdog Information
Status : Enabled
Console#
```

watchdog software This command monitors key processes, and automatically reboots the system if any of these processes are not responding correctly.

SYNTAX

watchdog software {disable | enable}

DEFAULT SETTING

Disabled

COMMAND MODE

Privileged Exec

EXAMPLE

```
Console#watchdog
Console#
```

FRAME SIZE

This section describes commands used to configure the Ethernet frame size on the switch.

Table 56: Frame Size Commands

Command	Function	Mode
jumbo frame	Enables support for jumbo frames	GC

jumbo frame This command enables support for Layer 2 jumbo frames for Gigabit Ethernet ports. Use the **no** form to disable it.

SYNTAX

[no] jumbo frame

DEFAULT SETTING

Disabled

COMMAND MODE

Global Configuration

COMMAND USAGE

- ◆ This switch provides more efficient throughput for large sequential data transfers by supporting Layer 2 jumbo frames on Gigabit Ethernet ports or trunks up to 10240 bytes. Compared to standard Ethernet frames that run only up to 1.5 KB, using jumbo frames significantly reduces the per-packet overhead required to process protocol encapsulation fields.

- ◆ To use jumbo frames, both the source and destination end nodes (such as a computer or server) must support this feature. Also, when the connection is operating at full duplex, all switches in the network between the two end nodes must be able to accept the extended frame size. And for half-duplex connections, all devices in the collision domain would need to support jumbo frames.
- ◆ The current setting for jumbo frames can be displayed with the `show system` command.

EXAMPLE

```
Console(config)#jumbo frame
Console(config)#
```

FILE MANAGEMENT

Managing Firmware

Firmware can be uploaded and downloaded to or from an FTP/TFTP server. By saving runtime code to a file on an FTP/TFTP server, that file can later be downloaded to the switch to restore operation. The switch can also be set to use new firmware without overwriting the previous version.

When downloading runtime code, the destination file name can be specified to replace the current image, or the file can be first downloaded using a different name from the current runtime code file, and then the new file set as the startup file.

Saving or Restoring Configuration Settings

Configuration settings can be uploaded and downloaded to and from an FTP/TFTP server. The configuration file can be later downloaded to restore switch settings.

The configuration file can be downloaded under a new file name and then set as the startup file, or the current startup configuration file can be specified as the destination file to directly replace it. Note that the file "Factory_Default_Config.cfg" can be copied to the FTP/TFTP server, but cannot be used as the destination on the switch.

Table 57: Flash/File Commands

Command	Function	Mode
<i>General Commands</i>		
<code>boot system</code>	Specifies the file or image used to start up the system	GC
<code>copy</code>	Copies a code image or a switch configuration to or from flash memory or an FTP/TFTP server	PE
<code>delete</code>	Deletes a file or code image	PE
<code>dir</code>	Displays a list of files in flash memory	PE

Table 57: Flash/File Commands (Continued)

Command	Function	Mode
<code>whichboot</code>	Displays the files booted	PE
<i>Automatic Code Upgrade Commands</i>		
<code>upgrade opcode auto</code>	Automatically upgrades the current image when a new version is detected on the indicated server	GC
<code>upgrade opcode path</code>	Specifies an FTP/TFTP server and directory in which the new opcode is stored	GC
<code>upgrade opcode reload</code>	Reloads the switch automatically after the opcode upgrade is completed	GC
<code>show upgrade</code>	Shows the opcode upgrade configuration settings.	PE
<i>TFTP Configuration Commands</i>		
<code>ip tftp retry</code>	Specifies the number of times the switch can retry transmitting a request to a TFTP server	GC
<code>ip tftp timeout</code>	Specifies the time the switch can wait for a response from a TFTP server before retransmitting a request or timing out for the last retry	GC
<code>show ip tftp</code>	Displays information about TFTP settings	PE

General Commands

boot system This command specifies the file or image used to start up the system.

SYNTAX

boot system {**boot-rom** | **config** | **opcode**}: *filename*

boot-rom* - Boot ROM.

config* - Configuration file.

opcode* - Run-time operation code.

filename - Name of configuration file or code image.

* The colon (:) is required.

DEFAULT SETTING

None

COMMAND MODE

Global Configuration

COMMAND USAGE

- ◆ A colon (:) is required after the specified file type.
- ◆ If the file contains an error, it cannot be set as the default file.

EXAMPLE

```
Console(config)#boot system config: startup
Console(config)#
```

RELATED COMMANDS

[dir \(742\)](#)
[whichboot \(743\)](#)

copy This command moves (upload/download) a code image or configuration file between the switch's flash memory and an FTP/TFTP server. When you save the system code or configuration settings to a file on an FTP/TFTP server, that file can later be downloaded to the switch to restore system operation. The success of the file transfer depends on the accessibility of the FTP/TFTP server and the quality of the network connection.

SYNTAX

copy file {file | ftp | running-config | startup-config | tftp}

copy running-config {file | ftp | startup-config | tftp}

copy startup-config {file | ftp | running-config | tftp}

copy tftp {add-to-running-config | file | https-certificate | public-key | running-config | startup-config}

add-to-running-config - Keyword that adds the settings listed in the specified file to the running configuration.

file - Keyword that allows you to copy to/from a file.

ftp - Keyword that allows you to copy to/from an FTP server.

https-certificate - Keyword that allows you to copy the HTTPS secure site certificate.

public-key - Keyword that allows you to copy a SSH key from a TFTP server. (See "Secure Shell" on page 853.)

running-config - Keyword that allows you to copy to/from the current running configuration.

startup-config - The configuration used for system initialization.

tftp - Keyword that allows you to copy to/from a TFTP server.

DEFAULT SETTING

None

COMMAND MODE

Privileged Exec

COMMAND USAGE

- ◆ The system prompts for data required to complete the copy command.
- ◆ The destination file name should not contain slashes (\ or /), and the maximum length for file names is 32 characters for files on the switch or 127 characters for files on the server. (Valid characters: A-Z, a-z, 0-9, ".", "-")
- ◆ The switch supports only two operation code files, but the maximum number of user-defined configuration files is 16.

- ◆ You can use "Factory_Default_Config.cfg" as the source to copy from the factory default configuration file, but you cannot use it as the destination.
- ◆ To replace the startup configuration, you must use **startup-config** as the destination.
- ◆ The Boot ROM and Loader cannot be uploaded or downloaded from the FTP/TFTP server. You must follow the instructions in the release notes for new firmware, or contact your distributor for help.
- ◆ For information on specifying an https-certificate, see "Replacing the Default Secure-site Certificate" on page 342. For information on configuring the switch to use HTTPS for a secure connection, see the ip http secure-server command.
- ◆ When logging into an FTP server, the interface prompts for a user name and password configured on the remote server. Note that "anonymous" is set as the default user name.

EXAMPLE

The following example shows how to download new firmware from a TFTP server:

```
Console#copy tftp file
TFTP server ip address: 10.1.0.19
Choose file type:
  1. config:  2. opcode: <1-2>: 2
Source file name: m360.bix
Destination file name: m360.bix
\Write to FLASH Programming.
-Write to FLASH finish.
Success.
Console#
```

The following example shows how to upload the configuration settings to a file on the TFTP server:

```
Console#copy file tftp
Choose file type:
  1. config:  2. opcode: 1
Source file name: startup
TFTP server ip address: 10.1.0.99
Destination file name: startup.01
TFTP completed.
Success.

Console#
```

The following example shows how to copy the running configuration to a startup file.

```
Console#copy running-config file
destination file name: startup
Write to FLASH Programming.
\Write to FLASH finish.
Success.

Console#
```

The following example shows how to download a configuration file:

```
Console#copy tftp startup-config
TFTP server ip address: 10.1.0.99
Source configuration file name: startup.01
Startup configuration file name [startup]:
Write to FLASH Programming.

\Write to FLASH finish.
Success.

Console#
```

This example shows how to copy a secure-site certificate from an TFTP server. It then reboots the switch to activate the certificate:

```
Console#copy tftp https-certificate
TFTP server ip address: 10.1.0.19
Source certificate file name: SS-certificate
Source private file name: SS-private
Private password: *****

Success.
Console#reload
System will be restarted, continue <y/n>? y
```

This example shows how to copy a public-key used by SSH from an TFTP server. Note that public key authentication via SSH is only supported for users configured locally on the switch.

```
Console#copy tftp public-key
TFTP server IP address: 192.168.1.19
Choose public key type:
 1. RSA:  2. DSA: 1
Source file name: steve.pub
Username: steve
TFTP Download
Success.
Write to FLASH Programming.
Success.

Console#
```

This example shows how to copy a file to an FTP server.

```
Console#copy ftp file
FTP server IP address: 169.254.1.11
User[anonymous]: admin
Password[]: *****
Choose file type:
 1. config:  2. opcode: 2
Source file name: BLANC.BIX
Destination file name: BLANC.BIX
Console#
```

delete This command deletes a file or image.

SYNTAX

delete file name *filename*

filename - Name of configuration file or code image.

DEFAULT SETTING

None

COMMAND MODE

Privileged Exec

COMMAND USAGE

- ◆ If the file type is used for system startup, then this file cannot be deleted.
- ◆ "Factory_Default_Config.cfg" cannot be deleted.

EXAMPLE

This example shows how to delete the test2.cfg configuration file from flash memory.

```
Console#delete file name test2.cfg
Console#
```

RELATED COMMANDS

[dir \(742\)](#)

[delete public-key \(858\)](#)

dir This command displays a list of files in flash memory.

SYNTAX

dir {**boot-rom:** | **config:** | **opcode:**} [*filename*]

boot-rom - Boot ROM (or diagnostic) image file.

config - Switch configuration file.

opcode - Run-time operation code image file.

filename - Name of configuration file or code image. If this file exists but contains errors, information on this file cannot be shown.

DEFAULT SETTING

None

COMMAND MODE

Privileged Exec

COMMAND USAGE

- ◆ If you enter the command **dir** without any parameters, the system displays all files.

File information is shown below:

Table 58: File Directory Information

Column Heading	Description
File Name	The name of the file.
File Type	File types: Boot-Rom, Operation Code, and Config file.
Startup	Shows if this file is used when the system is started.
Create Time	The date and time the file was created.
Size	The length of the file in bytes.

EXAMPLE

The following example shows how to display all file information:

```

Console#dir
      File Name                Type  Startup Modify Time          Size(bytes)
-----
Unit 1:
ECS4110-52P_V1.0.14.0.bix      OpCode  Y    1970-01-01 00:00:00      8559848
Factory_Default_Config.cfg     Config  N    2014-05-08 08:58:44         455
startupl.cfg                   Config  Y    2014-05-08 08:59:03         1588
-----
Free space for compressed user config files: 1413120
Console#
    
```

whichboot This command displays which files were booted when the system powered up.

SYNTAX

whichboot

DEFAULT SETTING

None

COMMAND MODE

Privileged Exec

EXAMPLE

This example shows the information displayed by the **whichboot** command. See the table under the **dir** command for a description of the file information displayed by this command.

```

Console#whichboot
  File Name                               Type  Startup Modify Time          Size(bytes)
-----
Unit 1:
ECS4110-52P_V1.0.14.0.bix                OpCode   Y   1970-01-01 00:00:00      8559848
startup1.cfg                             Config   Y   2014-05-08 08:59:03         1588
Console#

```

Automatic Code Upgrade Commands

upgrade opcode auto This command automatically upgrades the current operational code when a new version is detected on the server indicated by the [upgrade opcode path](#) command. Use the **no** form of this command to restore the default setting.

SYNTAX

[no] upgrade opcode auto

DEFAULT SETTING

Disabled

COMMAND MODE

Global Configuration

COMMAND USAGE

◆ This command is used to enable or disable automatic upgrade of the operational code. When the switch starts up and automatic image upgrade is enabled by this command, the switch will follow these steps when it boots up:

1. It will search for a new version of the image at the location specified by [upgrade opcode path](#) command. The name for the new image

stored on the TFTP server must be `ecs4110-series.bix`. If the switch detects a code version newer than the one currently in use, it will download the new image. If two code images are already stored in the switch, the image not set to start up the system will be overwritten by the new version.

2. After the image has been downloaded, the switch will send a trap message to log whether or not the upgrade operation was successful.
 3. It sets the new version as the startup image.
 4. It then restarts the system to start using the new image.
- ◆ Any changes made to the default setting can be displayed with the `show running-config` or `show startup-config` commands.

EXAMPLE

```
Console(config)#upgrade opcode auto
Console(config)#upgrade opcode path tftp://192.168.0.1/sm24/
Console(config)#
```

If a new image is found at the specified location, the following type of messages will be displayed during bootup.

```
:
Automatic Upgrade is looking for a new image
New image detected: current version 1.0.1.5; new version 1.1.2.0
Image upgrade in progress
The switch will restart after upgrade succeeds
Downloading new image
Flash programming started
Flash programming completed
The switch will now restart
:
```

upgrade opcode path This command specifies an TFTP server and directory in which the new opcode is stored. Use the **no** form of this command to clear the current setting.

SYNTAX

upgrade opcode path *opcode-dir-url*

no upgrade opcode path

opcode-dir-url - The location of the new code.

DEFAULT SETTING

None

COMMAND MODE

Global Configuration

COMMAND USAGE

- ◆ This command is used in conjunction with the [upgrade opcode auto](#) command to facilitate automatic upgrade of new operational code stored at the location indicated by this command.
- ◆ The name for the new image stored on the TFTP server must be `ecs4110-series.bix`. However, note that file name is not to be included in this command.
- ◆ When specifying a TFTP server, the following syntax must be used, where *filedir* indicates the path to the directory containing the new image:

```
tftp://192.168.0.1[/filedir]/
```

- ◆ When specifying an FTP server, the following syntax must be used, where *filedir* indicates the path to the directory containing the new image:

```
ftp://[username[:password@]]192.168.0.1[/filedir]/
```

If the user name is omitted, "anonymous" will be used for the connection. If the password is omitted a null string ("") will be used for the connection.

EXAMPLE

This shows how to specify a TFTP server where new code is stored.

```
Console(config)#upgrade opcode path tftp://192.168.0.1/sm24/
Console(config)#
```

This shows how to specify an FTP server where new code is stored.

```
Console(config)#upgrade opcode path ftp://admin:billy@192.168.0.1/sm24/
Console(config)#
```

upgrade opcode reload This command reloads the switch automatically after the opcode upgrade is completed. Use the **no** form to disable this feature.

SYNTAX

[no] upgrade opcode reload

DEFAULT SETTING

Disabled

COMMAND MODE

Global Configuration

EXAMPLE

This shows how to specify a TFTP server where new code is stored.

```
Console(config)#upgrade opcode reload
Console(config)#
```

show upgrade This command shows the opcode upgrade configuration settings.

COMMAND MODE

Privileged Exec

EXAMPLE

```
Console#show upgrade
Auto Image Upgrade Global Settings:
  Status      : Disabled
  Reload Status : Disabled
  Path        :
  File Name   : ecs4110-series.bix
Console#
```

TFTP Configuration Commands

ip tftp retry This command specifies the number of times the switch can retry transmitting a request to a TFTP server after waiting for the configured timeout period and receiving no response. Use the **no** form to restore the default setting.

SYNTAX

ip tftp retry *retries*

no ip tftp retry

retries - The number of times the switch can resend a request to a TFTP server before it aborts the connection. (Range: 1-16)

DEFAULT SETTING

15

COMMAND MODE

Global Configuration

EXAMPLE

```
Console(config)#ip tftp retry 10
Console(config)#
```

ip tftp timeout This command specifies the time the switch can wait for a response from a TFTP server before retransmitting a request or timing out for the last retry. Use the **no** form to restore the default setting.

SYNTAX

ip tftp timeout *seconds*

no ip tftp timeout

seconds - The the time the switch can wait for a response from a TFTP server before retransmitting a request or timing out.
(Range: 1-65535 seconds)

DEFAULT SETTING

5 seconds

COMMAND MODE

Global Configuration

EXAMPLE

```
Console(config)#ip tftp timeout 10
Console(config)#
```

show ip tftp This command displays information about the TFTP settings configured on this switch.

SYNTAX

show ip tftp

COMMAND MODE

Privileged Exec

EXAMPLE

```
Console#show ip tftp
TFTP Settings:
  Retries : 15
  Timeout : 5 seconds
Console#
```

LINE

You can access the onboard configuration program by attaching a VT100 compatible device to the server's serial port. These commands are used to set communication parameters for the serial port or Telnet (i.e., a virtual terminal).

Table 59: Line Commands

Command	Function	Mode
<code>line</code>	Identifies a specific line for configuration and starts the line configuration mode	GC
<code>accounting commands</code>	Applies an accounting method to commands entered at specific CLI privilege levels	LC
<code>accounting exec</code>	Applies an accounting method to local console, Telnet or SSH connections	LC
<code>authorization exec</code>	Applies an authorization method to local console, Telnet or SSH connections	LC
<code>databits*</code>	Sets the number of data bits per character that are interpreted and generated by hardware	LC
<code>exec-timeout</code>	Sets the interval that the command interpreter waits until user input is detected	LC
<code>login</code>	Enables password checking at login	LC
<code>parity*</code>	Defines the generation of a parity bit	LC
<code>password</code>	Specifies a password on a line	LC
<code>password-thresh</code>	Sets the password intrusion threshold, which limits the number of failed logon attempts	LC
<code>silent-time*</code>	Sets the amount of time the management console is inaccessible after the number of unsuccessful logon attempts exceeds the threshold set by the <code>password-thresh</code> command	LC
<code>speed*</code>	Sets the terminal baud rate	LC
<code>stopbits*</code>	Sets the number of the stop bits transmitted per byte	LC
<code>timeout login response</code>	Sets the interval that the system waits for a login attempt	LC
<code>disconnect</code>	Terminates a line connection	PE
<code>terminal</code>	Configures terminal settings, including escape-character, line length, terminal type, and width	PE
<code>show line</code>	Displays a terminal line's parameters	NE, PE

* These commands only apply to the serial port.

line This command identifies a specific line for configuration, and to process subsequent line configuration commands.

SYNTAX

line {**console** | **vty**}

console - Console terminal line.

vty - Virtual terminal for remote console access (i.e., Telnet).

DEFAULT SETTING

There is no default line.

COMMAND MODE

Global Configuration

COMMAND USAGE

Telnet is considered a virtual terminal connection and will be shown as "VTY" in screen displays such as [show users](#). However, the serial communication parameters (e.g., databits) do not affect Telnet connections.

EXAMPLE

To enter console line mode, enter the following command:

```
Console(config)#line console
Console(config-line)#
```

RELATED COMMANDS

[show line \(758\)](#)

[show users \(733\)](#)

databits This command sets the number of data bits per character that are interpreted and generated by the console port. Use the **no** form to restore the default value.

SYNTAX

databits {**7** | **8**}

no databits

7 - Seven data bits per character.

8 - Eight data bits per character.

DEFAULT SETTING

8 data bits per character

COMMAND MODE

Line Configuration

COMMAND USAGE

The **databits** command can be used to mask the high bit on input from devices that generate 7 data bits with parity. If parity is being generated, specify 7 data bits per character. If no parity is required, specify 8 data bits per character.

EXAMPLE

To specify 7 data bits, enter this command:

```
Console(config-line)#databits 7
Console(config-line)#
```

RELATED COMMANDS

[parity \(752\)](#)

exec-timeout This command sets the interval that the system waits until user input is detected. Use the **no** form to restore the default.

SYNTAX

exec-timeout [*seconds*]

no exec-timeout

seconds - Integer that specifies the timeout interval.
(Range: 60 - 65535 seconds; 0: no timeout)

DEFAULT SETTING

10 minutes

COMMAND MODE

Line Configuration

COMMAND USAGE

- ◆ If user input is detected within the timeout interval, the session is kept open; otherwise the session is terminated.
- ◆ This command applies to both the local console and Telnet connections.
- ◆ The timeout for Telnet cannot be disabled.
- ◆ Using the command without specifying a timeout restores the default setting.

EXAMPLE

To set the timeout to two minutes, enter this command:

```
Console(config-line)#exec-timeout 120
Console(config-line)#
```

login This command enables password checking at login. Use the **no** form to disable password checking and allow connections without a password.

SYNTAX

login [**local**]

no login

local - Selects local password checking. Authentication is based on the user name specified with the [username](#) command.

DEFAULT SETTING

login local

COMMAND MODE

Line Configuration

COMMAND USAGE

- ◆ There are three authentication modes provided by the switch itself at login:
 - **login** selects authentication by a single global password as specified by the [password](#) line configuration command. When using this method, the management interface starts in Normal Exec (NE) mode.
 - **login local** selects authentication via the user name and password specified by the [username](#) command (i.e., default setting). When using this method, the management interface starts in Normal Exec (NE) or Privileged Exec (PE) mode, depending on the user's privilege level (0 or 15 respectively).
 - **no login** selects no authentication. When using this method, the management interface starts in Normal Exec (NE) mode.
- ◆ This command controls login authentication via the switch itself. To configure user names and passwords for remote authentication servers, you must use the RADIUS or TACACS software installed on those servers.

EXAMPLE

```
Console(config-line)#login local
Console(config-line)#
```

RELATED COMMANDS

[username \(825\)](#)
[password \(752\)](#)

parity This command defines the generation of a parity bit. Use the **no** form to restore the default setting.

SYNTAX

parity { **none** | **even** | **odd** }

no parity

none - No parity

even - Even parity

odd - Odd parity

DEFAULT SETTING

No parity

COMMAND MODE

Line Configuration

COMMAND USAGE

Communication protocols provided by devices such as terminals and modems often require a specific parity bit setting.

EXAMPLE

To specify no parity, enter this command:

```
Console(config-line)#parity none
Console(config-line)#
```

password This command specifies the password for a line. Use the **no** form to remove the password.

SYNTAX

password { **0** | **7** } *password*

no password

{ **0** | **7** } - 0 means plain password, 7 means encrypted password

password - Character string that specifies the line password.
(Maximum length: 32 characters plain text or encrypted, case sensitive)

DEFAULT SETTING

No password is specified.

COMMAND MODE

Line Configuration

COMMAND USAGE

- ◆ When a connection is started on a line with password protection, the system prompts for the password. If you enter the correct password, the system shows a prompt. You can use the [password-thresh](#) command to set the number of times a user can enter an incorrect password before the system terminates the line connection and returns the terminal to the idle state.
- ◆ The encrypted password is required for compatibility with legacy password settings (i.e., plain text or encrypted) when reading the configuration file during system bootup or when downloading the configuration file from a TFTP server. There is no need for you to manually configure encrypted passwords.

EXAMPLE

```
Console(config-line)#password 0 secret
Console(config-line)#
```

RELATED COMMANDS[login \(751\)](#)[password-thresh \(753\)](#)

password-thresh This command sets the password intrusion threshold which limits the number of failed logon attempts. Use the **no** form to remove the threshold value.

SYNTAX

password-thresh [*threshold*]

no password-thresh

threshold - The number of allowed password attempts.
(Range: 1-120; 0: no threshold)

DEFAULT SETTING

The default value is three attempts.

COMMAND MODE

Line Configuration

COMMAND USAGE

When the logon attempt threshold is reached, the system interface becomes silent for a specified amount of time before allowing the next logon attempt. (Use the [silent-time](#) command to set this interval.) When this threshold is reached for Telnet, the Telnet logon interface shuts down.

EXAMPLE

To set the password threshold to five attempts, enter this command:

```
Console(config-line)#password-thresh 5  
Console(config-line)#
```

RELATED COMMANDS

[silent-time \(754\)](#)

silent-time This command sets the amount of time the management console is inaccessible after the number of unsuccessful logon attempts exceeds the threshold set by the [password-thresh](#) command. Use the **no** form to remove the silent time value.

SYNTAX

silent-time [*seconds*]

no silent-time

seconds - The number of seconds to disable console response.
(Range: 0-65535; where 0 means disabled)

DEFAULT SETTING

Disabled

COMMAND MODE

Line Configuration

EXAMPLE

To set the silent time to 60 seconds, enter this command:

```
Console(config-line)#silent-time 60  
Console(config-line)#
```

RELATED COMMANDS

[password-thresh \(753\)](#)

speed This command sets the terminal line's baud rate. This command sets both the transmit (to terminal) and receive (from terminal) speeds. Use the **no** form to restore the default setting.

SYNTAX

speed *bps*

no speed

bps - Baud rate in bits per second.
(Options: 9600, 19200, 38400, 57600, 115200 bps)

DEFAULT SETTING

115200 bps

COMMAND MODE

Line Configuration

COMMAND USAGE

Set the speed to match the baud rate of the device connected to the serial port. Some baud rates available on devices connected to the port might not be supported. The system indicates if the speed you selected is not supported.

EXAMPLE

To specify 57600 bps, enter this command:

```
Console(config-line)#speed 57600
Console(config-line)#
```

stopbits This command sets the number of the stop bits transmitted per byte. Use the **no** form to restore the default setting.

SYNTAX**stopbits** {1 | 2}**no stopbits**

1 - One stop bit

2 - Two stop bits

DEFAULT SETTING

1 stop bit

COMMAND MODE

Line Configuration

EXAMPLE

To specify 2 stop bits, enter this command:

```
Console(config-line)#stopbits 2
Console(config-line)#
```

timeout login response This command sets the interval that the system waits for a user to log into the CLI. Use the **no** form to restore the default setting.

SYNTAX

timeout login response [*seconds*]

no timeout login response

seconds - Integer that specifies the timeout interval.
(Range: 10 - 300 seconds)

DEFAULT SETTING

300 seconds

COMMAND MODE

Line Configuration

COMMAND USAGE

- ◆ If a login attempt is not detected within the timeout interval, the connection is terminated for the session.
- ◆ This command applies to both the local console and Telnet connections.
- ◆ The timeout for Telnet cannot be disabled.
- ◆ Using the command without specifying a timeout restores the default setting.

EXAMPLE

To set the timeout to two minutes, enter this command:

```
Console(config-line)#timeout login response 120  
Console(config-line)#
```

disconnect This command terminates an SSH, Telnet, or console connection.

SYNTAX

disconnect *session-id*

session-id - The session identifier for an SSH, Telnet or console connection. (Range: 0-8)

COMMAND MODE

Privileged Exec

COMMAND USAGE

Specifying session identifier "0" will disconnect the console connection. Specifying any other identifiers for an active session will disconnect an SSH or Telnet connection.

EXAMPLE

```
Console#disconnect 1
Console#
```

RELATED COMMANDS

[show ssh \(862\)](#)
[show users \(733\)](#)

terminal This command configures terminal settings, including escape-character, lines displayed, terminal type, width, and command history. Use the **no** form with the appropriate keyword to restore the default setting.

SYNTAX

```
terminal {escape-character {ASCII-number | character} |  
history [size size] | length length | terminal-type {ansi-bbs |  
vt-100 | vt-102} | width width}
```

escape-character - The keyboard character used to escape from current line input.

ASCII-number - ASCII decimal equivalent. (Range: 0-255)

character - Any valid keyboard character.

history - The number of lines stored in the command buffer, and recalled using the arrow keys. (Range: 0-256)

length - The number of lines displayed on the screen. (Range: 0-512, where 0 means not to pause)

terminal-type - The type of terminal emulation used.

ansi-bbs - ANSI-BBS

vt-100 - VT-100

vt-102 - VT-102

width - The number of character columns displayed on the terminal. (Range: 0-80)

DEFAULT SETTING

Escape Character: 27 (ASCII-number)

History: 10

Length: 24

Terminal Type: VT100

Width: 80

COMMAND MODE

Privileged Exec

EXAMPLE

This example sets the number of lines displayed by commands with lengthy output such as `show running-config` to 48 lines.

```
Console#terminal length 48
Console#
```

show line This command displays the terminal line's parameters.

SYNTAX

show line [console | vty]

console - Console terminal line.

vty - Virtual terminal for remote console access (i.e., Telnet).

DEFAULT SETTING

Shows all lines

COMMAND MODE

Normal Exec, Privileged Exec

EXAMPLE

To show all lines, enter this command:

```
Console#show line
Terminal Configuration for this session:
Length                : 24
Width                 : 80
History Size          : 10
Escape Character(ASCII-number) : 27
Terminal Type         : VT100

Console Configuration:
Password Threshold : 3 times
EXEC Timeout       : 600 seconds
Login Timeout      : 300 seconds
Silent Time        : Disabled
Baud Rate          : 115200
Data Bits          : 8
Parity             : None
Stop Bits          : 1

VTY Configuration:
Password Threshold : 3 times
EXEC Timeout       : 600 seconds
Login Timeout      : 300 sec.
Silent Time        : Disabled

Console#
```

EVENT LOGGING

This section describes commands used to configure event logging on the switch.

Table 60: Event Logging Commands

Command	Function	Mode
<code>logging facility</code>	Sets the facility type for remote logging of syslog messages	GC
<code>logging history</code>	Limits syslog messages saved to switch memory based on severity	GC
<code>logging host</code>	Adds a syslog server host IP address that will receive logging messages	GC
<code>logging on</code>	Controls logging of error messages	GC
<code>logging trap</code>	Limits syslog messages saved to a remote server based on severity	GC
<code>clear log</code>	Clears messages from the logging buffer	PE
<code>show log</code>	Displays log messages	PE
<code>show logging</code>	Displays the state of logging	PE

logging facility This command sets the facility type for remote logging of syslog messages. Use the **no** form to return the type to the default.

SYNTAX

logging facility *type*

no logging facility

type - A number that indicates the facility used by the syslog server to dispatch log messages to an appropriate service. (Range: 16-23)

DEFAULT SETTING

23

COMMAND MODE

Global Configuration

COMMAND USAGE

The command specifies the facility type tag sent in syslog messages. (See RFC 3164.) This type has no effect on the kind of messages reported by the switch. However, it may be used by the syslog server to sort messages or to store messages in the corresponding database.

EXAMPLE

```
Console(config)#logging facility 19
Console(config)#
```

logging history This command limits syslog messages saved to switch memory based on severity. The **no** form returns the logging of syslog messages to the default level.

SYNTAX

logging history {flash | ram} level

no logging history {flash | ram}

flash - Event history stored in flash memory (i.e., permanent memory).

ram - Event history stored in temporary RAM (i.e., memory flushed on power reset).

level - One of the levels listed below. Messages sent include the selected level down to level 0. (Range: 0-7)

Table 61: Logging Levels

Level	Severity Name	Description
7	debugging	Debugging messages
6	informational	Informational messages only
5	notifications	Normal but significant condition, such as cold start
4	warnings	Warning conditions (e.g., return false, unexpected return)
3	errors	Error conditions (e.g., invalid input, default used)
2	critical	Critical conditions (e.g., memory allocation, or free memory error - resource exhausted)
1	alerts	Immediate action needed
0	emergencies	System unusable

DEFAULT SETTING

Flash: errors (level 3 - 0)

RAM: debugging (level 7 - 0)

COMMAND MODE

Global Configuration

COMMAND USAGE

The message level specified for flash memory must be a higher priority (i.e., numerically lower) than that specified for RAM.

EXAMPLE

```
Console(config)#logging history ram 0  
Console(config)#
```

logging host This command adds a syslog server host IP address that will receive logging messages. Use the **no** form to remove a syslog server host.

SYNTAX

logging host *host-ip-address* [**port** *udp-port*]

no logging host *host-ip-address*

host-ip-address - The IPv4 or IPv6 address of a syslog server.

udp-port - The UDP port number used by the remote server.
(Range: 1-65535)

DEFAULT SETTING

UPD Port: 514

COMMAND MODE

Global Configuration

COMMAND USAGE

- ◆ Use this command more than once to build up a list of host IP addresses.
- ◆ The maximum number of host IP addresses allowed is five.

EXAMPLE

```
Console(config)#logging host 10.1.0.3
Console(config)#
```

logging on This command controls logging of error messages, sending debug or error messages to a logging process. The **no** form disables the logging process.

SYNTAX

[**no**] **logging on**

DEFAULT SETTING

None

COMMAND MODE

Global Configuration

COMMAND USAGE

The logging process controls error messages saved to switch memory or sent to remote syslog servers. You can use the [logging history](#) command to control the type of error messages that are stored in memory. You can use the [logging trap](#) command to control the type of error messages that are sent to specified syslog servers.

EXAMPLE

```
Console(config)#logging on  
Console(config)#
```

RELATED COMMANDS

[logging history \(760\)](#)

[logging trap \(762\)](#)

[clear log \(763\)](#)

logging trap This command enables the logging of system messages to a remote server, or limits the syslog messages saved to a remote server based on severity. Use this command without a specified level to enable remote logging. Use the **no** form to disable remote logging.

SYNTAX

logging trap [*level level*]

no logging trap [*level*]

level - One of the syslog severity levels listed in the table on [page 760](#). Messages sent include the selected level through level 0.

DEFAULT SETTING

Disabled

Level 7

COMMAND MODE

Global Configuration

COMMAND USAGE

- ◆ Using this command with a specified level enables remote logging and sets the minimum severity level to be saved.
- ◆ Using this command without a specified level also enables remote logging, but restores the minimum severity level to the default.

EXAMPLE

```
Console(config)#logging trap 4  
Console(config)#
```

clear log This command clears messages from the log buffer.

SYNTAX

clear log [**flash** | **ram**]

flash - Event history stored in flash memory (i.e., permanent memory).

ram - Event history stored in temporary RAM (i.e., memory flushed on power reset).

DEFAULT SETTING

Flash and RAM

COMMAND MODE

Privileged Exec

EXAMPLE

```
Console#clear log
Console#
```

RELATED COMMANDS

[show log \(763\)](#)

show log This command displays the log messages stored in local memory.

SYNTAX

show log {**flash** | **ram**}

flash - Event history stored in flash memory (i.e., permanent memory).

ram - Event history stored in temporary RAM (i.e., memory flushed on power reset).

DEFAULT SETTING

None

COMMAND MODE

Privileged Exec

COMMAND USAGE

- ◆ All log messages are retained in RAM and Flash after a warm restart (i.e., power is reset through the command interface).
- ◆ All log messages are retained in Flash and purged from RAM after a cold restart (i.e., power is turned off and then on through the power source).

EXAMPLE

The following example shows the event message stored in RAM.

```
Console#show log ram
[1] 00:01:30 2001-01-01
    "VLAN 1 link-up notification."
    level: 6, module: 5, function: 1, and event no.: 1
[0] 00:01:30 2001-01-01
    "Unit 1, Port 1 link-up notification."
    level: 6, module: 5, function: 1, and event no.: 1
Console#
```

show logging This command displays the configuration settings for logging messages to local switch memory, to an SMTP event handler, or to a remote syslog server.

SYNTAX

show logging {flash | ram | sendmail | trap}

flash - Displays settings for storing event messages in flash memory (i.e., permanent memory).

ram - Displays settings for storing event messages in temporary RAM (i.e., memory flushed on power reset).

sendmail - Displays settings for the SMTP event handler ([page 769](#)).

trap - Displays settings for the trap function.

DEFAULT SETTING

None

COMMAND MODE

Privileged Exec

EXAMPLE

The following example shows that system logging is enabled, the message level for flash memory is "errors" (i.e., default level 3 - 0), and the message level for RAM is "debugging" (i.e., default level 7 - 0).

```
Console#show logging flash
Syslog logging:          Enabled
History logging in FLASH: level errors
Console#show logging ram
Syslog logging:          Enabled
History logging in RAM: level debugging
Console#
```

Table 62: show logging flash/ram - display description

Field	Description
Syslog logging	Shows if system logging has been enabled via the logging on command.
History logging in FLASH	The message level(s) reported based on the logging history command.
History logging in RAM	The message level(s) reported based on the logging history command.

The following example displays settings for the trap function.

```

Console#show logging trap
Remote Log Status           : Enabled
Remote Log Facility Type    : Local use 7
Remote Log Level Type       : Debugging messages
Remote Log Server IP Address : 1.2.3.4
Remote Log Server IP Address : 0.0.0.0
Remote Log Server IP Address : 0.0.0.0
Remote Log Server IP Address : 0.0.0.0
Remote Log Server IP Address : 0.0.0.0
Console#

```

Table 63: show logging trap - display description

Field	Description
Remote Log Status	Shows if remote logging has been enabled via the logging trap command.
Remote Log Facility Type	The facility type for remote logging of syslog messages as specified in the logging facility command.
Remote Log Level Type	The severity threshold for syslog messages sent to a remote server as specified in the logging trap command.
Remote Log Server IP Address	The address of syslog servers as specified in the logging host command.

RELATED COMMANDS

[show logging sendmail \(769\)](#)

SMTP ALERTS

These commands configure SMTP event handling, and forwarding of alert messages to the specified SMTP servers and email recipients.

Table 64: Event Logging Commands

Command	Function	Mode
<code>logging sendmail</code>	Enables SMTP event handling	GC
<code>logging sendmail host</code>	SMTP servers to receive alert messages	GC
<code>logging sendmail level</code>	Severity threshold used to trigger alert messages	GC
<code>logging sendmail destination-email</code>	Email recipients of alert messages	GC
<code>logging sendmail source-email</code>	Email address used for "From" field of alert messages	GC
<code>show logging sendmail</code>	Displays SMTP event handler settings	NE, PE

logging sendmail This command enables SMTP event handling. Use the **no** form to disable this function.

SYNTAX

[no] logging sendmail

DEFAULT SETTING

Enabled

COMMAND MODE

Global Configuration

EXAMPLE

```
Console(config)#logging sendmail
Console(config)#
```

logging sendmail host This command specifies SMTP servers that will be sent alert messages. Use the **no** form to remove an SMTP server.

SYNTAX

[no] logging sendmail host host

host - IPv4 or IPv6 address of an SMTP server that will be sent alert messages for event handling.

DEFAULT SETTING

None

COMMAND MODE

Global Configuration

COMMAND USAGE

- ◆ You can specify up to three SMTP servers for event handing. However, you must enter a separate command to specify each server.
- ◆ To send email alerts, the switch first opens a connection, sends all the email alerts waiting in the queue one by one, and finally closes the connection.
- ◆ To open a connection, the switch first selects the server that successfully sent mail during the last connection, or the first server configured by this command. If it fails to send mail, the switch selects the next server in the list and tries to send mail again. If it still fails, the system will repeat the process at a periodic interval. (A trap will be triggered if the switch cannot successfully open a connection.)

EXAMPLE

```
Console(config)#logging sendmail host 192.168.1.19
Console(config)#
```

logging sendmail level This command sets the severity threshold used to trigger alert messages. Use the **no** form to restore the default setting.

SYNTAX**logging sendmail level** *level***no logging sendmail level**

level - One of the system message levels ([page 760](#)). Messages sent include the selected level down to level 0. (Range: 0-7; Default: 7)

DEFAULT SETTING

Level 7

COMMAND MODE

Global Configuration

COMMAND USAGE

The specified level indicates an event threshold. All events at this level or higher will be sent to the configured email recipients. (For example, using Level 7 will report all events from level 7 to level 0.)

EXAMPLE

This example will send email alerts for system errors from level 3 through 0.

```
Console(config)#logging sendmail level 3  
Console(config)#
```

logging sendmail destination-email

This command specifies the email recipients of alert messages. Use the **no** form to remove a recipient.

SYNTAX

[no] logging sendmail destination-email *email-address*

email-address - The source email address used in alert messages.
(Range: 1-41 characters)

DEFAULT SETTING

None

COMMAND MODE

Global Configuration

COMMAND USAGE

You can specify up to five recipients for alert messages. However, you must enter a separate command to specify each recipient.

EXAMPLE

```
Console(config)#logging sendmail destination-email ted@this-company.com  
Console(config)#
```

logging sendmail source-email

This command sets the email address used for the "From" field in alert messages. Use the **no** form to restore the default value.

SYNTAX

logging sendmail source-email *email-address*

no logging sendmail source-email

email-address - The source email address used in alert messages.
(Range: 1-41 characters)

DEFAULT SETTING

None

COMMAND MODE

Global Configuration

COMMAND USAGE

You may use an symbolic email address that identifies the switch, or the address of an administrator responsible for the switch.

EXAMPLE

```
Console(config)#logging sendmail source-email bill@this-company.com
Console(config)#
```

**show logging
sendmail**

This command displays the settings for the SMTP event handler.

COMMAND MODE

Normal Exec, Privileged Exec

EXAMPLE

```
Console#show logging sendmail
SMTP servers
-----
192.168.1.19

SMTP Minimum Severity Level: 7

SMTP destination email addresses
-----
ted@this-company.com

SMTP Source Email Address: bill@this-company.com

SMTP Status: Enabled
Console#
```

TIME

The system clock can be dynamically set by polling a set of specified time servers (NTP or SNTP). Maintaining an accurate time on the switch enables the system log to record meaningful dates and times for event entries. If the clock is not set, the switch will only record the time from the factory default set at the last bootup.

Table 65: Time Commands

Command	Function	Mode
<i>SNTP Commands</i>		
<code>sntp client</code>	Accepts time from specified time servers	GC
<code>sntp poll</code>	Sets the interval at which the client polls for time	GC
<code>sntp server</code>	Specifies one or more time servers	GC
<code>show sntp</code>	Shows current SNTP configuration settings	NE, PE

Table 65: Time Commands (Continued)

Command	Function	Mode
<i>NTP Commands</i>		
<code>ntp authenticate</code>	Enables authentication for NTP traffic	GC
<code>ntp authentication-key</code>	Configures authentication keys	GC
<code>ntp client</code>	Enables the NTP client for time updates from specified servers	GC
<code>ntp server</code>	Specifies NTP servers to poll for time updates	GC
<code>show ntp</code>	Shows current NTP configuration settings	NE, PE
<i>Manual Configuration Commands</i>		
<code>clock summer-time (date)</code>	Configures summer time* for the switch's internal clock on a one-time basis	GC
<code>clock summer-time (predefined)</code>	Configures summer time for the switch's internal clock based on predefined settings	GC
<code>clock summer-time (recurring)</code>	Configures summer time for the switch's internal clock on a recurring basis	GC
<code>clock timezone</code>	Sets the time zone for the switch's internal clock	GC
<code>calendar set</code>	Sets the system date and time	PE
<code>show calendar</code>	Displays the current date and time setting	NE, PE

* Daylight savings time.

SNTP Commands

sntp client This command enables SNTP client requests for time synchronization from NTP or SNTP time servers specified with the `sntp server` command. Use the **no** form to disable SNTP client requests.

SYNTAX

[no] sntp client

DEFAULT SETTING

Disabled

COMMAND MODE

Global Configuration

COMMAND USAGE

- ◆ The time acquired from time servers is used to record accurate dates and times for log events. Without SNTP, the switch only records the time starting from the factory default set at the last bootup (i.e., 00:00:00, Jan. 1, 2001).
- ◆ This command enables client time requests to time servers specified via the `sntp server` command. It issues time synchronization requests based on the interval set via the `sntp poll` command.

EXAMPLE

```
Console(config)#ntp server 10.1.0.19
Console(config)#ntp poll 60
Console(config)#ntp client
Console(config)#end
Console#show ntp
Current Time: Dec 23 02:52:44 2002
Poll Interval: 60
Current Mode: unicast
SNTP Status : Enabled
SNTP Server 137.92.140.80 0.0.0.0 0.0.0.0
Current Server: 137.92.140.80
Console#
```

RELATED COMMANDS

[ntp server \(772\)](#)

[ntp poll \(771\)](#)

[show ntp \(772\)](#)

ntp poll This command sets the interval between sending time requests when the switch is set to SNTP client mode. Use the **no** form to restore to the default.

SYNTAX

ntp poll *seconds*

no ntp poll

seconds - Interval between time requests.
(Range: 16-16384 seconds)

DEFAULT SETTING

16 seconds

COMMAND MODE

Global Configuration

EXAMPLE

```
Console(config)#ntp poll 60
Console#
```

RELATED COMMANDS

[ntp client \(770\)](#)

sntp server This command sets the IP address of the servers to which SNTP time requests are issued. Use the this command with no arguments to clear all time servers from the current list. Use the **no** form to clear all time servers from the current list, or to clear a specific server.

SYNTAX

sntp server [*ip1* [*ip2* [*ip3*]]]

no sntp server [*ip1* [*ip2* [*ip3*]]]

ip - IP address of a time server (NTP or SNTP).
(Range: 1 - 3 addresses)

DEFAULT SETTING

None

COMMAND MODE

Global Configuration

COMMAND USAGE

This command specifies time servers from which the switch will poll for time updates when set to SNTP client mode. The client will poll the time servers in the order specified until a response is received. It issues time synchronization requests based on the interval set via the [sntp poll](#) command.

EXAMPLE

```
Console(config)#sntp server 10.1.0.19
Console#
```

RELATED COMMANDS

[sntp client \(770\)](#)

[sntp poll \(771\)](#)

[show sntp \(772\)](#)

show sntp This command displays the current time and configuration settings for the SNTP client, and indicates whether or not the local time has been properly updated.

COMMAND MODE

Normal Exec, Privileged Exec

COMMAND USAGE

This command displays the current time, the poll interval used for sending time synchronization requests, and the current SNTP mode (i.e., unicast).

EXAMPLE

```
Console#show sntp
Current Time   : Nov  5 18:51:22 2006
Poll Interval  : 16 seconds
Current Mode   : Unicast
SNTP Status    : Enabled
SNTP Server    : 137.92.140.80 0.0.0.0 0.0.0.0
Current Server : 137.92.140.80
Console#
```

NTP Commands

ntp authenticate This command enables authentication for NTP client-server communications. Use the **no** form to disable authentication.

SYNTAX

[no] ntp authenticate

DEFAULT SETTING

Disabled

COMMAND MODE

Global Configuration

COMMAND USAGE

You can enable NTP authentication to ensure that reliable updates are received from only authorized NTP servers. The authentication keys and their associated key number must be centrally managed and manually distributed to NTP servers and clients. The key numbers and key values must match on both the server and client.

EXAMPLE

```
Console(config)#ntp authenticate
Console(config)#
```

RELATED COMMANDS

[ntp authentication-key \(774\)](#)

ntp authentication-key This command configures authentication keys and key numbers to use when NTP authentication is enabled. Use the **no** form of the command to clear a specific authentication key or all keys from the current list.

SYNTAX

ntp authentication-key *number* **md5** *key*

no ntp authentication-key [*number*]

number - The NTP authentication key ID number. (Range: 1-65535)

md5 - Specifies that authentication is provided by using the message digest algorithm 5.

key - An MD5 authentication key string. The key string can be up to 32 case-sensitive printable ASCII characters (no spaces).

DEFAULT SETTING

None

COMMAND MODE

Global Configuration

COMMAND USAGE

- ◆ The key number specifies a key value in the NTP authentication key list. Up to 255 keys can be configured on the switch. Re-enter this command for each server you want to configure.
- ◆ Note that NTP authentication key numbers and values must match on both the server and client.
- ◆ NTP authentication is optional. When enabled with the **ntp authenticate** command, you must also configure at least one key number using this command.
- ◆ Use the **no** form of this command without an argument to clear all authentication keys in the list.

EXAMPLE

```
Console(config)#ntp authentication-key 45 md5 thisiskey45
Console(config)#
```

RELATED COMMANDS

[ntp authenticate \(773\)](#)

ntp client This command enables NTP client requests for time synchronization from NTP time servers specified with the **ntp servers** command. Use the **no** form to disable NTP client requests.

SYNTAX

[**no**] **ntp client**

DEFAULT SETTING

Disabled

COMMAND MODE

Global Configuration

COMMAND USAGE

- ◆ The SNTP and NTP clients cannot be enabled at the same time. First disable the SNTP client before using this command.
- ◆ The time acquired from time servers is used to record accurate dates and times for log events. Without NTP, the switch only records the time starting from the factory default set at the last bootup (i.e., 00:00:00, Jan. 1, 2001).
- ◆ This command enables client time requests to time servers specified via the **ntp servers** command. It issues time synchronization requests based on the interval set via the **ntp poll** command.

EXAMPLE

```
Console(config)#ntp client
Console(config)#
```

RELATED COMMANDS[sntp client \(770\)](#)[ntp server \(775\)](#)

ntp server This command sets the IP addresses of the servers to which NTP time requests are issued. Use the **no** form of the command to clear a specific time server or all servers from the current list.

SYNTAX

ntp server *ip-address* [**key** *key-number*]

no ntp server [*ip-address*]

ip-address - IP address of an NTP time server.

key-number - The number of an authentication key to use in communications with the server. (Range: 1-65535)

DEFAULT SETTING

Version number: 3

COMMAND MODE

Global Configuration

COMMAND USAGE

- ◆ This command specifies time servers that the switch will poll for time updates when set to NTP client mode. It issues time synchronization

requests based on the interval set with the **ntp poll** command. The client will poll all the time servers configured, the responses received are filtered and compared to determine the most reliable and accurate time update for the switch.

- ◆ You can configure up to 50 NTP servers on the switch. Re-enter this command for each server you want to configure.
- ◆ NTP authentication is optional. If enabled with the **ntp authenticate** command, you must also configure at least one key number using the **ntp authentication-key** command.
- ◆ Use the **no** form of this command without an argument to clear all configured servers in the list.

EXAMPLE

```
Console(config)#ntp server 192.168.3.20
Console(config)#ntp server 192.168.3.21
Console(config)#ntp server 192.168.5.23 key 19
Console(config)#
```

RELATED COMMANDS

[ntp client \(774\)](#)
[show ntp \(776\)](#)

show ntp This command displays the current time and configuration settings for the NTP client, and indicates whether or not the local time has been properly updated.

COMMAND MODE

Normal Exec, Privileged Exec

COMMAND USAGE

This command displays the current time, the poll interval used for sending time synchronization requests, and the current NTP mode (i.e., unicast).

EXAMPLE

```
Console#show ntp
Current Time           : Apr 29 13:57:32 2011
Polling                : 1024 seconds
Current Mode           : unicast
NTP Status              : Disabled
NTP Authenticate Status : Enabled
Last Update NTP Server : 0.0.0.0          Port: 0
Last Update Time       : Jan  1 00:00:00 1970 UTC
NTP Server 192.168.3.20 version 3
NTP Server 192.168.3.21 version 3
NTP Server 192.168.4.22 version 3 key 19
NTP Authentication Key 19 md5 42V68751663T6K11P2J307210R885
Console#
```

Manual Configuration Commands

clock summer-time (date) This command sets the start, end, and offset times of summer time (daylight savings time) for the switch on a one-time basis. Use the **no** form to disable summer time.

SYNTAX

clock summer-time *name* **date** *b-date b-month b-year b-hour b-minute e-date e-month e-year e-hour e-minute [offset]*

no clock summer-time

name - Name of the time zone while summer time is in effect, usually an acronym. (Range: 1-30 characters)

b-date - Day of the month when summer time will begin. (Range: 1-31)

b-month - The month when summer time will begin. (Options: **january** | **february** | **march** | **april** | **may** | **june** | **july** | **august** | **september** | **october** | **november** | **december**)

b-year - The year summer time will begin.

b-hour - The hour summer time will begin. (Range: 0-23 hours)

b-minute - The minute summer time will begin. (Range: 0-59 minutes)

e-date - Day of the month when summer time will end. (Range: 1-31)

e-month - The month when summer time will end. (Options: **january** | **february** | **march** | **april** | **may** | **june** | **july** | **august** | **september** | **october** | **november** | **december**)

e-year - The year summer time will end.

e-hour - The hour summer time will end. (Range: 0-23 hours)

e-minute - The minute summer time will end. (Range: 0-59 minutes)

offset - Summer time offset from the regular time zone, in minutes. (Range: 0-99 minutes)

DEFAULT SETTING

Disabled

COMMAND MODE

Global Configuration

COMMAND USAGE

- ◆ In some countries or regions, clocks are adjusted through the summer months so that afternoons have more daylight and mornings have less. This is known as Summer Time, or Daylight Savings Time (DST). Typically, clocks are adjusted forward one hour at the start of spring and then adjusted backward in autumn.

- ◆ This command sets the summer-time time zone relative to the currently configured time zone. To specify a time corresponding to your local time when summer time is in effect, you must indicate the number of minutes your summer-time time zone deviates from your regular time zone.

EXAMPLE

```
Console(config)#clock summer-time DEST date april 1 2007 23 23 april 23 2007
23 23 60
Console(config)#
```

RELATED COMMANDS

[show sntp \(772\)](#)

clock summer-time (predefined) This command configures the summer time (daylight savings time) status and settings for the switch using predefined configurations for several major regions in the world. Use the **no** form to disable summer time.

SYNTAX

clock summer-time *name* **predefined** [**australia** | **europe** | **new-zealand** | **usa**]

no clock summer-time

name - Name of the timezone while summer time is in effect, usually an acronym. (Range: 1-30 characters)

DEFAULT SETTING

Disabled

COMMAND MODE

Global Configuration

COMMAND USAGE

- ◆ In some countries or regions, clocks are adjusted through the summer months so that afternoons have more daylight and mornings have less. This is known as Summer Time, or Daylight Savings Time (DST). Typically, clocks are adjusted forward one hour at the start of spring and then adjusted backward in autumn.
- ◆ This command sets the summer-time time relative to the configured time zone. To specify the time corresponding to your local time when summer time is in effect, select the predefined summer-time time zone appropriate for your location, or manually configure summer time if these predefined configurations do not apply to your location (see [clock summer-time \(date\)](#) or [clock summer-time \(recurring\)](#)).

Table 66: Predefined Summer-Time Parameters

Region	Start Time, Day, Week, & Month	End Time, Day, Week, & Month	Rel. Offset
Australia	00:00:00, Sunday, Week 5 of October	23:59:59, Sunday, Week 5 of March	60 min
Europe	00:00:00, Sunday, Week 5 of March	23:59:59, Sunday, Week 5 of October	60 min
New Zealand	00:00:00, Sunday, Week 1 of October	23:59:59, Sunday, Week 3 of March	60 min
USA	00:00:00, Sunday, Week 2 of March	23:59:59, Sunday, Week 1 of November	60 min

EXAMPLE

```
Console(config)#clock summer-time MESZ predefined europe
Console(config)#
```

RELATED COMMANDS

[show sntp \(772\)](#)

clock summer-time (recurring) This command allows the user to manually configure the start, end, and offset times of summer time (daylight savings time) for the switch on a recurring basis. Use the **no** form to disable summer-time.

SYNTAX

clock summer-time *name* **recurring** *b-week b-day b-month b-hour b-minute e-week e-day e-month e-hour e-minute [offset]*

no clock summer-time

name - Name of the timezone while summer time is in effect, usually an acronym. (Range: 1-30 characters)

b-week - The week of the month when summer time will begin. (Range: 1-5)

b-day - The day of the week when summer time will begin. (Options: **sunday** | **monday** | **tuesday** | **wednesday** | **thursday** | **friday** | **saturday**)

b-month - The month when summer time will begin. (Options: **january** | **february** | **march** | **april** | **may** | **june** | **july** | **august** | **september** | **october** | **november** | **december**)

b-hour - The hour when summer time will begin. (Range: 0-23 hours)

b-minute - The minute when summer time will begin. (Range: 0-59 minutes)

e-week - The week of the month when summer time will end. (Range: 1-5)

e-day - The day of the week summer time will end. (Options: **sunday** | **monday** | **tuesday** | **wednesday** | **thursday** | **friday** | **saturday**)

e-month - The month when summer time will end. (Options: **january** | **february** | **march** | **april** | **may** | **june** | **july** | **august** | **september** | **october** | **november** | **december**)

e-hour - The hour when summer time will end. (Range: 0-23 hours)

e-minute - The minute when summer time will end. (Range: 0-59 minutes)

offset - Summer-time offset from the regular time zone, in minutes. (Range: 0-99 minutes)

DEFAULT SETTING

Disabled

COMMAND MODE

Global Configuration

COMMAND USAGE

- ◆ In some countries or regions, clocks are adjusted through the summer months so that afternoons have more daylight and mornings have less. This is known as Summer Time, or Daylight Savings Time (DST). Typically, clocks are adjusted forward one hour at the start of spring and then adjusted backward in autumn.
- ◆ This command sets the summer-time time zone relative to the currently configured time zone. To display a time corresponding to your local time when summer time is in effect, you must indicate the number of minutes your summer-time time zone deviates from your regular time zone.

EXAMPLE

```
Console(config)#clock summer-time MESZ recurring 1 friday june 23 59 3
saturday september 2 55 60
Console(config)#
```

RELATED COMMANDS

[show sntp \(772\)](#)

clock timezone This command sets the time zone for the switch's internal clock.

SYNTAX

clock timezone *name* **hour** *hours* **minute** *minutes*
{**before-utc** | **after-utc**}

name - Name of timezone, usually an acronym. (Range: 1-30 characters)

hours - Number of hours before/after UTC. (Range: 0-12 hours before UTC, 0-13 hours after UTC)

minutes - Number of minutes before/after UTC. (Range: 0-59 minutes)

before-utc - Sets the local time zone before (east) of UTC.

after-utc - Sets the local time zone after (west) of UTC.

DEFAULT SETTING

None

COMMAND MODE

Global Configuration

COMMAND USAGE

This command sets the local time zone relative to the Coordinated Universal Time (UTC, formerly Greenwich Mean Time or GMT), based on the earth's prime meridian, zero degrees longitude. To display a time corresponding to your local time, you must indicate the number of hours and minutes your time zone is east (before) or west (after) of UTC.

EXAMPLE

```
Console(config)#clock timezone Japan hours 8 minute 0 after-UTC
Console(config)#
```

RELATED COMMANDS

[show sntp \(772\)](#)

calendar set This command sets the system clock. It may be used if there is no time server on your network, or if you have not configured the switch to receive signals from a time server.

SYNTAX

calendar set *hour min sec {day month year | month day year}*

hour - Hour in 24-hour format. (Range: 0 - 23)

min - Minute. (Range: 0 - 59)

sec - Second. (Range: 0 - 59)

day - Day of month. (Range: 1 - 31)

month - **january** | **february** | **march** | **april** | **may** | **june** | **july** | **august** | **september** | **october** | **november** | **december**

year - Year (4-digit). (Range: 1970-2037)

DEFAULT SETTING

None

COMMAND MODE

Privileged Exec

COMMAND USAGE

Note that when SNTP is enabled, the system clock cannot be manually configured.

EXAMPLE

This example shows how to set the system clock to 15:12:34, February 1st, 2012.

```
Console#calendar set 15:12:34 1 February 2012
Console#
```

show calendar This command displays the system clock.

DEFAULT SETTING

None

COMMAND MODE

Normal Exec, Privileged Exec

EXAMPLE

```
Console#show calendar
Current Time       : Dec 28 18:14:47 2013
Time Zone         : UTC, 00:00
Summer Time       : Not configured
Summer Time in Effect : No
Console#
```

TIME RANGE

This section describes the commands used to sets a time range for use by other functions, such as Access Control Lists.

Table 67: Time Range Commands

Command	Function	Mode
time-range	Specifies the name of a time range, and enters time range configuration mode	GC
absolute	Sets the time range for the execution of a command	TR
periodic	Sets the time range for the periodic execution of a command	TR
show time-range	Shows configured time ranges.	PE

time-range This command specifies the name of a time range, and enters time range configuration mode. Use the **no** form to remove a previously specified time range.

SYNTAX

[no] time-range *name*

name - Name of the time range. (Range: 1-16 characters)

DEFAULT SETTING

None

COMMAND MODE

Global Configuration

COMMAND USAGE

- ◆ This command sets a time range for use by other functions, such as Access Control Lists.
- ◆ A maximum of seven rules can be configured for a time range.

EXAMPLE

```
Console(config)#time-range r&d  
Console(config-time-range)#
```

RELATED COMMANDS

[Access Control Lists \(969\)](#)

absolute This command sets the time range for the execution of a command. Use the **no** form to remove a previously specified time.

SYNTAX

absolute start *hour minute day month year*
[**end** *hour minutes day month year*]

absolute end *hour minutes day month year*

no absolute

hour - Hour in 24-hour format. (Range: 0-23)

minute - Minute. (Range: 0-59)

day - Day of month. (Range: 1-31)

month - **january** | **february** | **march** | **april** | **may** | **june** | **july** | **august** | **september** | **october** | **november** | **december**

year - Year (4-digit). (Range: 2009-2037)

DEFAULT SETTING

None

COMMAND MODE

Time Range Configuration

COMMAND USAGE

- ◆ If a time range is already configured, you must use the **no** form of this command to remove the current entry prior to configuring a new time range.
- ◆ If both an absolute rule and one or more periodic rules are configured for the same time range (i.e., named entry), that entry will only take effect if the current time is within the absolute time range and one of the periodic time ranges.

EXAMPLE

This example configures the time for the single occurrence of an event.

```
Console(config)#time-range r&d
Console(config-time-range)#absolute start 1 1 1 april 2009 end 2 1 1 april
2009
Console(config-time-range)#
```

periodic This command sets the time range for the periodic execution of a command. Use the **no** form to remove a previously specified time range.

SYNTAX

```
[no] periodic {daily | friday | monday | saturday | sunday |
thursday | tuesday | wednesday | weekdays | weekend}
hour minute to {daily | friday | monday | saturday | sunday |
thursday | tuesday | wednesday | weekdays | weekend |
hour minute}
```

daily - Daily

friday - Friday

monday - Monday

saturday - Saturday

sunday - Sunday

thursday - Thursday

tuesday - Tuesday

wednesday - Wednesday

weekdays - Weekdays

weekend - Weekends

hour - Hour in 24-hour format. (Range: 0-23)

minute - Minute. (Range: 0-59)

DEFAULT SETTING

None

COMMAND MODE

Time Range Configuration

COMMAND USAGE

- ◆ If a time range is already configured, you must use the **no** form of this command to remove the current entry prior to configuring a new time range.
- ◆ If both an absolute rule and one or more periodic rules are configured for the same time range (i.e., named entry), that entry will only take effect if the current time is within the absolute time range and one of the periodic time ranges.

EXAMPLE

This example configures a time range for the periodic occurrence of an event.

```
Console(config)#time-range sales
Console(config-time-range)#periodic daily 1 1 to 2 1
Console(config-time-range)#
```

show time-range This command shows configured time ranges.

SYNTAX

show time-range [*name*]

name - Name of the time range. (Range: 1-16 characters)

DEFAULT SETTING

None

COMMAND MODE

Privileged Exec

EXAMPLE

```
Console#show time-range r&d
Time-range r&d:
  absolute start 01:01 01 April 2009
  periodic   Daily 01:01 to   Daily 02:01
  periodic   Daily 02:01 to   Daily 03:01
Console#
```

SWITCH CLUSTERING

Switch Clustering is a method of grouping switches together to enable centralized management through a single unit. Switches that support clustering can be grouped together regardless of physical location or switch type, as long as they are connected to the same local network.

Table 68: Switch Cluster Commands

Command	Function	Mode
<code>cluster</code>	Configures clustering on the switch	GC
<code>cluster commander</code>	Configures the switch as a cluster Commander	GC
<code>cluster ip-pool</code>	Sets the cluster IP address pool for Members	GC
<code>cluster member</code>	Sets Candidate switches as cluster members	GC
<code>rcommand</code>	Provides configuration access to Member switches	GC
<code>show cluster</code>	Displays the switch clustering status	PE
<code>show cluster members</code>	Displays current cluster Members	PE
<code>show cluster candidates</code>	Displays current cluster Candidates in the network	PE

Using Switch Clustering

- ◆ A switch cluster has a primary unit called the “Commander” which is used to manage all other “Member” switches in the cluster. The management station can use either Telnet or the web interface to communicate directly with the Commander through its IP address, and then use the Commander to manage the Member switches through the cluster’s “internal” IP addresses.
- ◆ Clustered switches must be in the same Ethernet broadcast domain. In other words, clustering only functions for switches which can pass information between the Commander and potential Candidates or active Members through VLAN 4093.
- ◆ Once a switch has been configured to be a cluster Commander, it automatically discovers other cluster-enabled switches in the network. These “Candidate” switches only become cluster Members when manually selected by the administrator through the management station.
- ◆ The cluster VLAN 4093 is not configured by default. Before using clustering, take the following actions to set up this VLAN:
 1. Create VLAN 4093 (see ["Editing VLAN Groups" on page 1155](#)).
 2. Add the participating ports to this VLAN (see ["Configuring VLAN Interfaces" on page 1157](#)), and set them to hybrid mode, tagged members, PVID = 1, and acceptable frame type = all.



NOTE: Cluster Member switches can be managed either through a Telnet connection to the Commander, or through a web management connection

to the Commander. When using a console connection, from the Commander CLI prompt, use the `rcommand` to connect to the Member switch.

cluster This command enables clustering on the switch. Use the **no** form to disable clustering.

SYNTAX

[no] cluster

DEFAULT SETTING

Disabled

COMMAND MODE

Global Configuration

COMMAND USAGE

- ◆ To create a switch cluster, first be sure that clustering is enabled on the switch (the default is enabled), then set the switch as a Cluster Commander. Set a Cluster IP Pool that does not conflict with any other IP subnets in the network. Cluster IP addresses are assigned to switches when they become Members and are used for communication between Member switches and the Commander.
- ◆ Switch clusters are limited to the same Ethernet broadcast domain.
- ◆ There can be up to 100 candidates and 36 member switches in one cluster.
- ◆ A switch can only be a Member of one cluster.
- ◆ Configured switch clusters are maintained across power resets and network changes.

EXAMPLE

```
Console(config)#cluster
Console(config)#
```

cluster commander This command enables the switch as a cluster Commander. Use the **no** form to disable the switch as cluster Commander.

SYNTAX

[no] cluster commander

DEFAULT SETTING

Disabled

COMMAND MODE

Global Configuration

COMMAND USAGE

- ◆ Once a switch has been configured to be a cluster Commander, it automatically discovers other cluster-enabled switches in the network. These "Candidate" switches only become cluster Members when manually selected by the administrator through the management station.
- ◆ Cluster Member switches can be managed through a Telnet connection to the Commander. From the Commander CLI prompt, use the `rcommand id` command to connect to the Member switch.

EXAMPLE

```
Console(config)#cluster commander  
Console(config)#
```

cluster ip-pool This command sets the cluster IP address pool. Use the **no** form to reset to the default address.

SYNTAX

cluster ip-pool *ip-address*

no cluster ip-pool

ip-address - The base IP address for IP addresses assigned to cluster Members. The IP address must start 10.x.x.x.

DEFAULT SETTING

10.254.254.1

COMMAND MODE

Global Configuration

COMMAND USAGE

- ◆ An "internal" IP address pool is used to assign IP addresses to Member switches in the cluster. Internal cluster IP addresses are in the form `10.x.x.member-ID`. Only the base IP address of the pool needs to be set since Member IDs can only be between 1 and 36.
- ◆ Set a Cluster IP Pool that does not conflict with addresses in the network IP subnet. Cluster IP addresses are assigned to switches when they become Members and are used for communication between Member switches and the Commander.
- ◆ You cannot change the cluster IP pool when the switch is currently in Commander mode. Commander mode must first be disabled.

EXAMPLE

```
Console(config)#cluster ip-pool 10.2.3.4
Console(config)#
```

cluster member This command configures a Candidate switch as a cluster Member. Use the **no** form to remove a Member switch from the cluster.

SYNTAX

cluster member mac-address *mac-address* **id** *member-id*

no cluster member id *member-id*

mac-address - The MAC address of the Candidate switch.

member-id - The ID number to assign to the Member switch.
(Range: 1-36)

DEFAULT SETTING

No Members

COMMAND MODE

Global Configuration

COMMAND USAGE

- ◆ The maximum number of cluster Members is 36.
- ◆ The maximum number of cluster Candidates is 100.

EXAMPLE

```
Console(config)#cluster member mac-address 00-12-34-56-78-9a id 5
Console(config)#
```

rcommand This command provides access to a cluster Member CLI for configuration.

SYNTAX

rcommand id *member-id*

member-id - The ID number of the Member switch.
(Range: 1-36)

COMMAND MODE

Privileged Exec

COMMAND USAGE

- ◆ This command only operates through a Telnet connection to the Commander switch. Managing cluster Members using the local console CLI on the Commander is not supported.

- ◆ There is no need to enter the username and password for access to the Member switch CLI.

EXAMPLE

```
Console#rcommand id 1

      CLI session with the ECS4110-52T is opened.
      To end the CLI session, enter [Exit].

Vty-0#
```

show cluster This command shows the switch clustering configuration.

COMMAND MODE
Privileged Exec

EXAMPLE

```
Console#show cluster
Role           : commander
Interval Heartbeat : 30
Heartbeat Loss Count : 3 seconds
Number of Members : 1
Number of Candidates : 2
Console#
```

show cluster members This command shows the current switch cluster members.

COMMAND MODE
Privileged Exec

EXAMPLE

```
Console#show cluster members
Cluster Members:
ID           : 1
Role        : Active member
IP Address   : 10.254.254.2
MAC Address  : 00-E0-0C-00-00-FE
Description  : ECS4110-52T Managed GE Switch
Console#
```

show cluster candidates This command shows the discovered Candidate switches in the network.

COMMAND MODE
Privileged Exec

EXAMPLE

```
Console#show cluster candidates
Cluster Candidates:
Role           MAC Address      Description
-----
Active member  00-E0-0C-00-00-FE ECS4110-52T Managed GE Switch
CANDIDATE      00-12-CF-0B-47-A0 ECS4110-52T Managed GE Switch
Console#
```

SNMP commands control access to this switch from management stations using the Simple Network Management Protocol (SNMP), as well as the error types sent to trap managers.

SNMP Version 3 also provides security features that cover message integrity, authentication, and encryption; as well as controlling user access to specific areas of the MIB tree. To use SNMPv3, first set an SNMP engine ID (or accept the default), specify read and write access views for the MIB tree, configure SNMP user groups with the required security model (i.e., SNMP v1, v2c or v3) and security level (i.e., authentication and privacy), and then assign SNMP users to these groups, along with their specific authentication and privacy passwords.

Table 69: SNMP Commands

Command	Function	Mode
<i>General SNMP Commands</i>		
<code>snmp-server</code>	Enables the SNMP agent	GC
<code>snmp-server community</code>	Sets up the community access string to permit access to SNMP commands	GC
<code>snmp-server contact</code>	Sets the system contact string	GC
<code>snmp-server location</code>	Sets the system location string	GC
<code>show snmp</code>	Displays the status of SNMP communications	NE, PE
<i>SNMP Target Host Commands</i>		
<code>snmp-server enable traps</code>	Enables the switch to send SNMP traps (i.e., SNMP notifications)	GC
<code>snmp-server host</code>	Specifies the recipient of an SNMP notification operation	GC
<code>snmp-server enable port-traps mac-notification</code>	Enables the device to send SNMP traps (i.e., SNMP notifications) when a dynamic MAC address is added or removed	IC
<code>show snmp-server enable port-traps</code>	Shows if SNMP traps are enabled or disabled for the specified interfaces	PE
<i>SNMPv3 Commands</i>		
<code>snmp-server engine-id</code>	Sets the SNMP engine ID	GC
<code>snmp-server group</code>	Adds an SNMP group, mapping users to views	GC
<code>snmp-server user</code>	Adds a user to an SNMP group	GC
<code>snmp-server view</code>	Adds an SNMP view	GC
<code>show snmp engine-id</code>	Shows the SNMP engine ID	PE
<code>show snmp group</code>	Shows the SNMP groups	PE
<code>show snmp user</code>	Shows the SNMP users	PE

Table 69: SNMP Commands (Continued)

Command	Function	Mode
<code>show snmp view</code>	Shows the SNMP views	PE
<i>Notification Log Commands</i>		
<code>nlm</code>	Enables the specified notification log	GC
<code>snmp-server notify-filter</code>	Creates a notification log and specifies the target host	GC
<code>show nlm oper-status</code>	Shows operation status of configured notification logs	PE
<code>show snmp notify-filter</code>	Displays the configured notification logs	PE
<i>ATC Trap Commands</i>		
<code>snmp-server enable port-traps atc broadcast-alarm-clear</code>	Sends a trap when broadcast traffic falls beneath the lower threshold after a storm control response has been triggered	IC (Port)
<code>snmp-server enable port-traps atc broadcast-alarm-fire</code>	Sends a trap when broadcast traffic exceeds the upper threshold for automatic storm control	IC (Port)
<code>snmp-server enable port-traps atc broadcast-control-apply</code>	Sends a trap when broadcast traffic exceeds the upper threshold for automatic storm control and the apply timer expires	IC (Port)
<code>snmp-server enable port-traps atc broadcast-control-release</code>	Sends a trap when broadcast traffic falls beneath the lower threshold after a storm control response has been triggered and the release timer expires	IC (Port)
<code>snmp-server enable port-traps atc multicast-alarm-clear</code>	Sends a trap when multicast traffic falls beneath the lower threshold after a storm control response has been triggered	IC (Port)
<code>snmp-server enable port-traps atc multicast-alarm-fire</code>	Sends a trap when multicast traffic exceeds the upper threshold for automatic storm control	IC (Port)
<code>snmp-server enable port-traps atc multicast-control-apply</code>	Sends a trap when multicast traffic exceeds the upper threshold for automatic storm control and the apply timer expires	IC (Port)
<code>snmp-server enable port-traps atc multicast-control-release</code>	Sends a trap when multicast traffic falls beneath the lower threshold after a storm control response has been triggered and the release timer expires	IC (Port)
<i>Connectivity Fault Management Trap Commands</i>		
<code>snmp-server enable traps ethernet cfm cc</code>	Enables SNMP traps for CFM continuity check events	GC
<code>snmp-server enable traps ethernet cfm crosscheck</code>	Enables SNMP traps for CFM continuity check events, in relation to the cross-check operations between statically configured MEPs and those learned via continuity check messages	GC
<i>Transceiver Power Threshold Trap Commands</i>		
<code>transceiver-threshold current</code>	Sends a trap when the transceiver current falls outside the specified thresholds	IC (Port)
<code>transceiver-threshold rx-power</code>	Sends a trap when the power level of the received signal falls outside the specified thresholds	IC (Port)
<code>transceiver-threshold temperature</code>	Sends a trap when the transceiver temperature falls outside the specified thresholds	IC (Port)
<code>transceiver-threshold tx-power</code>	Sends a trap when the power level of the transmitted signal power outside the specified thresholds	IC (Port)
<code>transceiver-threshold voltage</code>	Sends a trap when the transceiver voltage falls outside the specified thresholds	IC (Port)

Table 69: SNMP Commands (Continued)

Command	Function	Mode
<i>Additional Trap Commands</i>		
<code>memory</code>	Sets the rising and falling threshold for the memory utilization alarm	GC
<code>process cpu</code>	Sets the rising and falling threshold for the CPU utilization alarm	GC
<code>show memory</code>	Shows memory utilization parameters	PE
<code>show process cpu</code>	Shows CPU utilization parameters	PE

General SNMP Commands

snmp-server This command enables the SNMPv3 engine and services for all management clients (i.e., versions 1, 2c, 3). Use the **no** form to disable the server.

SYNTAX

[no] snmp-server

DEFAULT SETTING

Enabled

COMMAND MODE

Global Configuration

EXAMPLE

```
Console(config)#snmp-server
Console(config)#
```

snmp-server community This command defines community access strings used to authorize management access by clients using SNMP v1 or v2c. Use the **no** form to remove the specified community string.

SYNTAX

snmp-server community *string* [**ro** | **rw**]

no snmp-server community *string*

string - Community string that acts like a password and permits access to the SNMP protocol. (Maximum length: 32 characters, case sensitive; Maximum number of strings: 5)

ro - Specifies read-only access. Authorized management stations are only able to retrieve MIB objects.

rw - Specifies read/write access. Authorized management stations are able to both retrieve and modify MIB objects.

DEFAULT SETTING

- ◆ public - Read-only access. Authorized management stations are only able to retrieve MIB objects.
- ◆ private - Read/write access. Authorized management stations are able to both retrieve and modify MIB objects.

COMMAND MODE

Global Configuration

EXAMPLE

```
Console(config)#snmp-server community alpha rw
Console(config)#
```

snmp-server contact This command sets the system contact string. Use the **no** form to remove the system contact information.

SYNTAX

snmp-server contact *string*

no snmp-server contact

string - String that describes the system contact information.
(Maximum length: 255 characters)

DEFAULT SETTING

None

COMMAND MODE

Global Configuration

EXAMPLE

```
Console(config)#snmp-server contact Paul
Console(config)#
```

RELATED COMMANDS

[snmp-server location \(796\)](#)

snmp-server location This command sets the system location string. Use the **no** form to remove the location string.

SYNTAX

snmp-server location *text*

no snmp-server location

text - String that describes the system location.
(Maximum length: 255 characters)

DEFAULT SETTING

None

COMMAND MODE

Global Configuration

EXAMPLE

```
Console(config)#snmp-server location WC-19
Console(config)#
```

RELATED COMMANDS[snmp-server contact \(796\)](#)

show snmp This command can be used to check the status of SNMP communications.

DEFAULT SETTING

None

COMMAND MODE

Normal Exec, Privileged Exec

COMMAND USAGE

This command provides information on the community access strings, counters for SNMP input and output protocol data units, and whether or not SNMP logging has been enabled with the **snmp-server enable traps** command.

EXAMPLE

```
Console#show snmp

SNMP Agent : Enabled

SNMP Traps :
  Authentication : Enabled
  Link-up-down   : Enabled
  MAC-notification : Disabled
  MAC-notification interval : 1 second(s)

SNMP Communities :
  1. public, and the access level is read-only
  2. private, and the access level is read/write

0 SNMP packets input
  0 Bad SNMP version errors
  0 Unknown community name
  0 Illegal operation for community name supplied
  0 Encoding errors
  0 Number of requested variables
  0 Number of altered variables
  0 Get-request PDUs
  0 Get-next PDUs
  0 Set-request PDUs
```

```
0 SNMP packets output
  0 Too big errors
  0 No such name errors
  0 Bad values errors
  0 General errors
  0 Response PDUs
  0 Trap PDUs
```

```
SNMP Logging: Disabled
Console#
```

SNMP Target Host Commands

snmp-server enable traps This command enables this device to send Simple Network Management Protocol traps or informs (i.e., SNMP notifications). Use the **no** form to disable SNMP notifications.

SYNTAX

[no] snmp-server enable traps [authentication | link-up-down | ethernet cfm | mac-notification [interval *interval*]

authentication - Keyword to issue authentication failure notifications.

link-up-down - Keyword to issue link-up or link-down notifications.

ethernet cfm - Connectivity Fault Management traps. For more information on these traps, see ["CFM Commands" on page 1347](#).

mac-notification - Keyword to issue trap when a dynamic MAC address is added or removed.

interval - Specifies the interval between issuing two consecutive traps. (Range: 1-3600 seconds; Default: 1 second)

DEFAULT SETTING

Issues authentication and link-up-down traps.
Other traps are disabled.

COMMAND MODE

Global Configuration

COMMAND USAGE

- ◆ If you do not enter an **snmp-server enable traps** command, no notifications controlled by this command are sent. In order to configure this device to send SNMP notifications, you must enter at least one **snmp-server enable traps** command. If you enter the command with no keywords, both authentication and link-up-down notifications are enabled. If you enter the command with a keyword, only the notification type related to that keyword is enabled.
- ◆ The **snmp-server enable traps** command is used in conjunction with the [snmp-server host](#) command. Use the [snmp-server host](#) command to specify which host or hosts receive SNMP notifications. In order to

send notifications, you must configure at least one `snmp-server host` command.

- ◆ The authentication, link-up, and link-down traps are legacy notifications, and therefore when used for SNMP Version 3 hosts, they must be enabled in conjunction with the corresponding entries in the Notify View assigned by the `snmp-server group` command.

EXAMPLE

```
Console(config)#snmp-server enable traps link-up-down
Console(config)#
```

RELATED COMMANDS

`snmp-server host (799)`

snmp-server host This command specifies the recipient of a Simple Network Management Protocol notification operation. Use the **no** form to remove the specified host.

SYNTAX

```
snmp-server host host-addr [inform [retry retries |
timeout seconds]] community-string
[version {1 | 2c | 3 {auth | noauth | priv} [udp-port port]}]
```

```
no snmp-server host host-addr
```

host-addr - IPv4 or IPv6 address of the host (the targeted recipient). (Maximum host addresses: 5 trap destination IP address entries)

inform - Notifications are sent as inform messages. Note that this option is only available for version 2c and 3 hosts. (Default: traps are used)

retries - The maximum number of times to resend an inform message if the recipient does not acknowledge receipt. (Range: 0-255; Default: 3)

seconds - The number of seconds to wait for an acknowledgment before resending an inform message. (Range: 0-2147483647 centiseconds; Default: 1500 centiseconds)

community-string - Password-like community string sent with the notification operation to SNMP V1 and V2c hosts. Although you can set this string using the **snmp-server host** command by itself, we recommend defining it with the `snmp-server community` command prior to using the **snmp-server host** command. (Maximum length: 32 characters)

version - Specifies whether to send notifications as SNMP Version 1, 2c or 3 traps. (Range: 1, 2c, 3; Default: 1)

auth | noauth | priv - This group uses SNMPv3 with authentication, no authentication, or with authentication and privacy. See "[Simple Network Management Protocol](#)" on [page 452](#) for further information about these authentication and encryption options.

port - Host UDP port to use. (Range: 1-65535; Default: 162)

DEFAULT SETTING

Host Address: None
Notification Type: Traps
SNMP Version: 1
UDP Port: 162

COMMAND MODE

Global Configuration

COMMAND USAGE

- ◆ If you do not enter an **snmp-server host** command, no notifications are sent. In order to configure the switch to send SNMP notifications, you must enter at least one **snmp-server host** command. In order to enable multiple hosts, you must issue a separate **snmp-server host** command for each host.
- ◆ The **snmp-server host** command is used in conjunction with the [snmp-server enable traps](#) command. Use the [snmp-server enable traps](#) command to enable the sending of traps or informs and to specify which SNMP notifications are sent globally. For a host to receive notifications, at least one [snmp-server enable traps](#) command and the **snmp-server host** command for that host must be enabled.
- ◆ Some notification types cannot be controlled with the [snmp-server enable traps](#) command. For example, some notification types are always enabled.
- ◆ Notifications are issued by the switch as trap messages by default. The recipient of a trap message does not send a response to the switch. Traps are therefore not as reliable as inform messages, which include a request for acknowledgement of receipt. Informs can be used to ensure that critical information is received by the host. However, note that informs consume more system resources because they must be kept in memory until a response is received. Informs also add to network traffic. You should consider these effects when deciding whether to issue notifications as traps or informs.

To send an inform to a SNMPv2c host, complete these steps:

1. Enable the SNMP agent ([page 795](#)).
2. Create a view with the required notification messages ([page 806](#)).
3. Create a group that includes the required notify view ([page 804](#)).
4. Allow the switch to send SNMP traps; i.e., notifications ([page 798](#)).

5. Specify the target host that will receive inform messages with the **snmp-server host** command as described in this section.

To send an inform to a SNMPv3 host, complete these steps:

1. Enable the SNMP agent ([page 795](#)).
 2. Create a remote SNMPv3 user to use in the message exchange process ([page 805](#)).
 3. Create a view with the required notification messages ([page 806](#)).
 4. Create a group that includes the required notify view ([page 804](#)).
 5. Allow the switch to send SNMP traps; i.e., notifications ([page 798](#)).
 6. Specify the target host that will receive inform messages with the **snmp-server host** command as described in this section.
- ◆ The switch can send SNMP Version 1, 2c or 3 notifications to a host IP address, depending on the SNMP version that the management station supports. If the **snmp-server host** command does not specify the SNMP version, the default is to send SNMP version 1 notifications.
 - ◆ If you specify an SNMP Version 3 host, then the community string is interpreted as an SNMP user name. The user name must first be defined with the [snmp-server user](#) command. Otherwise, an SNMPv3 group will be automatically created by the **snmp-server host** command using the name of the specified community string, and default settings for the read, write, and notify view.

EXAMPLE

```
Console(config)#snmp-server host 10.1.19.23 batman
Console(config)#
```

RELATED COMMANDS

[snmp-server enable traps \(798\)](#)

snmp-server enable port-traps mac-notification

This command enables the device to send SNMP traps (i.e., SNMP notifications) when a dynamic MAC address is added or removed. Use the **no** form to restore the default setting.

SYNTAX

[no] snmp-server enable port-traps mac-notification

mac-notification - Keyword to issue trap when a dynamic MAC address is added or removed.

DEFAULT SETTING

Disabled

COMMAND MODE

Interface Configuration (Ethernet, Port Channel)

COMMAND USAGE

This command can enable MAC authentication traps on the current interface only if they are also enabled at the global level with the [snmp-server enable traps mac-authentication](#) command.

EXAMPLE

```
Console(config)#interface ethernet 1/1
Console(config-if)#snmp-server enable port-traps mac-notification
Console(config)#
```

show snmp-server enable port-traps This command shows if SNMP traps are enabled or disabled for the specified interfaces.

SYNTAX

show snmp-server enable port-traps interface [*interface*]

interface

ethernet *unit/port*

unit - Unit identifier. (Range: 1)

port - Port number. (Range: 1-28/52)

port-channel *channel-id* (Range: 1-16)

COMMAND MODE

Privileged Exec

EXAMPLE

```
Console#show snmp-server enable port-traps interface
Interface MAC Notification Trap
-----
Eth 1/1                                     No
Eth 1/2                                     No
Eth 1/3                                     No
:
```

SNMPv3 Commands

snmp-server engine-id This command configures an identification string for the SNMPv3 engine. Use the **no** form to restore the default.

SYNTAX

```
snmp-server engine-id {local | remote {ip-address}}  
engineid-string
```

```
no snmp-server engine-id {local | remote {ip-address}}
```

local - Specifies the SNMP engine on this switch.

remote - Specifies an SNMP engine on a remote device.

ip-address - IPv4 or IPv6 address of the remote device.

engineid-string - String identifying the engine ID. (Range: 9-64 hexadecimal characters)

DEFAULT SETTING

A unique engine ID is automatically generated by the switch based on its MAC address.

COMMAND MODE

Global Configuration

COMMAND USAGE

- ◆ An SNMP engine is an independent SNMP agent that resides either on this switch or on a remote device. This engine protects against message replay, delay, and redirection. The engine ID is also used in combination with user passwords to generate the security keys for authenticating and encrypting SNMPv3 packets.
- ◆ A remote engine ID is required when using SNMPv3 informs. (See the [snmp-server host](#) command.) The remote engine ID is used to compute the security digest for authentication and encryption of packets passed between the switch and a user on the remote host. SNMP passwords are localized using the engine ID of the authoritative agent. For informs, the authoritative SNMP agent is the remote agent. You therefore need to configure the remote agent's SNMP engine ID before you can send proxy requests or informs to it.
- ◆ Trailing zeroes need not be entered to uniquely specify a engine ID. In other words, the value "0123456789" is equivalent to "0123456789" followed by 16 zeroes for a local engine ID.
- ◆ A local engine ID is automatically generated that is unique to the switch. This is referred to as the default engine ID. If the local engine ID is deleted or changed, all SNMP users will be cleared. You will need to reconfigure all existing users ([page 805](#)).

EXAMPLE

```
Console(config)#snmp-server engine-id local 1234567890
Console(config)#snmp-server engineID remote 9876543210 192.168.1.19
Console(config)#
```

RELATED COMMANDS

[snmp-server host \(799\)](#)

snmp-server group This command adds an SNMP group, mapping SNMP users to SNMP views. Use the **no** form to remove an SNMP group.

SYNTAX

```
snmp-server group groupname
    {v1 | v2c | v3 {auth | noauth | priv}}
    [read readview] [write writeview] [notify notifyview]
```

```
no snmp-server group groupname
```

groupname - Name of an SNMP group. (Range: 1-32 characters)

v1 | **v2c** | **v3** - Use SNMP version 1, 2c or 3.

auth | **noauth** | **priv** - This group uses SNMPv3 with authentication, no authentication, or with authentication and privacy. See "[Simple Network Management Protocol](#)" on page 452 for further information about these authentication and encryption options.

readview - Defines the view for read access. (1-32 characters)

writeview - Defines the view for write access. (1-32 characters)

notifyview - Defines the view for notifications. (1-32 characters)

DEFAULT SETTING

Default groups: public¹⁹ (read only), private²⁰ (read/write)

readview - Every object belonging to the Internet OID space (1).

writeview - Nothing is defined.

notifyview - Nothing is defined.

COMMAND MODE

Global Configuration

COMMAND USAGE

- ◆ A group sets the access policy for the assigned users.
- ◆ When authentication is selected, the MD5 or SHA algorithm is used as specified in the [snmp-server user](#) command.
- ◆ When privacy is selected, the DES 56-bit algorithm is used for data encryption.

19. No view is defined.

20. Maps to the defaultview.

- ◆ For additional information on the notification messages supported by this switch, see [Table 34, "Supported Notification Messages," on page 462](#). Also, note that the authentication, link-up and link-down messages are legacy traps and must therefore be enabled in conjunction with the `snmp-server enable traps` command.

EXAMPLE

```
Console(config)#snmp-server group r&d v3 auth write daily
Console(config)#
```

snmp-server user This command adds a user to an SNMP group, restricting the user to a specific SNMP Read, Write, or Notify View. Use the **no** form to remove a user from an SNMP group.

SYNTAX

```
snmp-server user username groupname [remote ip-address]
  {v1 | v2c | v3 [encrypted] [auth {md5 | sha} auth-password
  [priv des56 priv-password]}
```

```
no snmp-server user username {v1 | v2c | v3 | remote}
```

username - Name of user connecting to the SNMP agent.
(Range: 1-32 characters)

groupname - Name of an SNMP group to which the user is assigned.
(Range: 1-32 characters)

remote - Specifies an SNMP engine on a remote device.

ip-address - IPv4 or IPv6 address of the remote device.

v1 | **v2c** | **v3** - Use SNMP version 1, 2c or 3.

encrypted - Accepts the password as encrypted input.

auth - Uses SNMPv3 with authentication.

md5 | **sha** - Uses MD5 or SHA authentication.

auth-password - Authentication password. Enter as plain text if the **encrypted** option is not used. Otherwise, enter an encrypted password. (Range: 8-32 characters)

priv des56 - Uses SNMPv3 with privacy with DES56 encryption.

priv-password - Privacy password. Enter as plain text if the **encrypted** option is not used. Otherwise, enter an encrypted password. (Range: 8-32 characters)

DEFAULT SETTING

None

COMMAND MODE

Global Configuration

COMMAND USAGE

- ◆ Local users (i.e., the command does not specify a remote engine identifier) must be configured to authorize management access for SNMPv3 clients, or to identify the source of SNMPv3 trap messages sent from the local switch.
- ◆ Remote users (i.e., the command specifies a remote engine identifier) must be configured to identify the source of SNMPv3 inform messages sent from the local switch.
- ◆ The SNMP engine ID is used to compute the authentication/privacy digests from the password. You should therefore configure the engine ID with the `snmp-server engine-id` command before using this configuration command.
- ◆ Before you configure a remote user, use the `snmp-server engine-id` command to specify the engine ID for the remote device where the user resides. Then use the `snmp-server user` command to specify the user and the IP address for the remote device where the user resides. The remote agent's SNMP engine ID is used to compute authentication/privacy digests from the user's password. If the remote engine ID is not first configured, the `snmp-server user` command specifying a remote user will fail.
- ◆ SNMP passwords are localized using the engine ID of the authoritative agent. For informs, the authoritative SNMP agent is the remote agent. You therefore need to configure the remote agent's SNMP engine ID before you can send proxy requests or informs to it.

EXAMPLE

```
Console(config)#snmp-server user steve group r&d v3 auth md5 greenpeace priv
des56 einstien
Console(config)#snmp-server user mark group r&d remote 192.168.1.19 v3 auth
md5 greenpeace priv des56 einstien
Console(config)#
```

snmp-server view This command adds an SNMP view which controls user access to the MIB. Use the **no** form to remove an SNMP view.

SYNTAX

snmp-server view *view-name oid-tree* {**included** | **excluded**}

no snmp-server view *view-name*

view-name - Name of an SNMP view. (Range: 1-32 characters)

oid-tree - Object identifier of a branch within the MIB tree. Wild cards can be used to mask a specific portion of the OID string. (Refer to the examples.)

included - Defines an included view.

excluded - Defines an excluded view.

DEFAULT SETTING

defaultview (includes access to the entire MIB tree)

COMMAND MODE

Global Configuration

COMMAND USAGE

- ◆ Views are used in the `snmp-server group` command to restrict user access to specified portions of the MIB tree.
- ◆ The predefined view "defaultview" includes access to the entire MIB tree.

EXAMPLES

This view includes MIB-2.

```
Console(config)#snmp-server view mib-2 1.3.6.1.2.1 included
Console(config)#
```

This view includes the MIB-2 interfaces table, `ifDescr`. The wild card is used to select all the index values in this table.

```
Console(config)#snmp-server view ifEntry.2 1.3.6.1.2.1.2.2.1.*.2 included
Console(config)#
```

This view includes the MIB-2 interfaces table, and the mask selects all index entries.

```
Console(config)#snmp-server view ifEntry.a 1.3.6.1.2.1.2.2.1.1.* included
Console(config)#
```

show snmp engine-id This command shows the SNMP engine ID.

COMMAND MODE

Privileged Exec

EXAMPLE

This example shows the default engine ID.

```
Console#show snmp engine-id
Local SNMP EngineID: 8000002a8000000000e8666672
Local SNMP EngineBoots: 1

Remote SNMP EngineID                               IP address
80000000030004e2b316c54321                         192.168.1.19
Console#
```

Table 70: show snmp engine-id - display description

Field	Description
Local SNMP engineID	String identifying the engine ID.
Local SNMP engineBoots	The number of times that the engine has (re-)initialized since the snmp EngineID was last configured.
Remote SNMP engineID	String identifying an engine ID on a remote device.
IP address	IP address of the device containing the corresponding remote SNMP engine.

show snmp group Four default groups are provided – SNMPv1 read-only access and read/write access, and SNMPv2c read-only access and read/write access.

COMMAND MODE

Privileged Exec

EXAMPLE

```
Console#show snmp group
Group Name: r&d
Security Model: v3
Read View: defaultview
Write View: daily
Notify View: none
Storage Type: permanent
Row Status: active

Group Name: public
Security Model: v1
Read View: defaultview
Write View: none
Notify View: none
Storage Type: volatile
Row Status: active

Group Name: public
Security Model: v2c
Read View: defaultview
Write View: none
Notify View: none
Storage Type: volatile
Row Status: active

Group Name: private
Security Model: v1
Read View: defaultview
Write View: defaultview
Notify View: none
Storage Type: volatile
Row Status: active

Group Name: private
Security Model: v2c
Read View: defaultview
Write View: defaultview
Notify View: none
Storage Type: volatile
Row Status: active
```

```
Console#
```

Table 71: show snmp group - display description

Field	Description
Group Name	Name of an SNMP group.
Security Model	The SNMP version.
Read View	The associated read view.
Write View	The associated write view.
Notify View	The associated notify view.
Storage Type	The storage type for this entry.
Row Status	The row status of this entry.

show snmp user This command shows information on SNMP users.

COMMAND MODE
Privileged Exec

EXAMPLE

```
Console#show snmp user
EngineId: 800000ca030030f1df9ca00000
User Name: steve
Authentication Protocol: md5
Privacy Protocol: des56
Storage Type: nonvolatile
Row Status: active

SNMP remote user
EngineId: 80000000030004e2b316c54321
User Name: mark
Authentication Protocol: mdt
Privacy Protocol: des56
Storage Type: nonvolatile
Row Status: active

Console#
```

Table 72: show snmp user - display description

Field	Description
EngineId	String identifying the engine ID.
User Name	Name of user connecting to the SNMP agent.
Authentication Protocol	The authentication protocol used with SNMPv3.
Privacy Protocol	The privacy protocol used with SNMPv3.
Storage Type	The storage type for this entry.

Table 72: show snmp user - display description (Continued)

Field	Description
Row Status	The row status of this entry.
SNMP remote user	A user associated with an SNMP engine on a remote device.

show snmp view This command shows information on the SNMP views.

COMMAND MODE

Privileged Exec

EXAMPLE

```

Console#show snmp view
View Name: mib-2
Subtree OID: 1.2.2.3.6.2.1
View Type: included
Storage Type: permanent
Row Status: active

View Name: defaultview
Subtree OID: 1
View Type: included
Storage Type: volatile
Row Status: active

Console#

```

Table 73: show snmp view - display description

Field	Description
View Name	Name of an SNMP view.
Subtree OID	A branch in the MIB tree.
View Type	Indicates if the view is included or excluded.
Storage Type	The storage type for this entry.
Row Status	The row status of this entry.

Notification Log Commands

nlm This command enables or disables the specified notification log.

SYNTAX

[no] nlm *filter-name*
filter-name - Notification log name. (Range: 1-32 characters)

DEFAULT SETTING

Enabled

COMMAND MODE

Global Configuration

COMMAND USAGE

- ◆ Notification logging is enabled by default, but will not start recording information until a logging profile specified by the `snmp-server notify-filter` command is enabled by the `nlm` command.
- ◆ Disabling logging with this command does not delete the entries stored in the notification log.

EXAMPLE

This example enables the notification log A1.

```
Console(config)#nlm A1
Console(config)#
```

snmp-server notify-filter This command creates an SNMP notification log. Use the **no** form to remove this log.

SYNTAX

[no] snmp-server notify-filter *profile-name* **remote** *ip-address*

profile-name - Notification log profile name. (Range: 1-32 characters)

ip-address - IPv4 or IPv6 address of a remote device. The specified target host must already have been configured using the `snmp-server host` command.



NOTE: The notification log is stored locally. It is not sent to a remote device. This remote host parameter is only required to complete mandatory fields in the SNMP Notification MIB.

DEFAULT SETTING

None

COMMAND MODE

Global Configuration

COMMAND USAGE

- ◆ Systems that support SNMP often need a mechanism for recording Notification information as a hedge against lost notifications, whether there are Traps or Informs that may be exceeding retransmission limits. The Notification Log MIB (NLM, RFC 3014) provides an infrastructure in which information from other MIBs may be logged.
- ◆ Given the service provided by the NLM, individual MIBs can now bear less responsibility to record transient information associated with an

event against the possibility that the Notification message is lost, and applications can poll the log to verify that they have not missed any important Notifications.

- ◆ If notification logging is not configured and enabled, when the switch reboots, some SNMP traps (such as warm start) cannot be logged.
- ◆ To avoid this problem, notification logging should be configured and enabled using the **snmp-server notify-filter** command and **nlm** command, and these commands stored in the startup configuration file. Then when the switch reboots, SNMP traps (such as warm start) can now be logged.
- ◆ When this command is executed, a notification log is created (with the default parameters defined in RFC 3014). Notification logging is enabled by default (see the **nlm** command), but will not start recording information until a logging profile specified with this command is enabled with the **nlm** command.
- ◆ Based on the default settings used in RFC 3014, a notification log can contain up to 256 entries, and the entry aging time is 1440 minutes. Information recorded in a notification log, and the entry aging time can only be configured using SNMP from a network management station.
- ◆ When a trap host is created with the **snmp-server host** command, a default notify filter will be created as shown in the example under the **show snmp notify-filter** command.

EXAMPLE

This example first creates an entry for a remote host, and then instructs the switch to record this device as the remote host for the specified notification log.

```
Console(config)#snmp-server host 10.1.19.23 batman
Console(config)#snmp-server notify-filter A1 remote 10.1.19.23
Console#
```

show nlm oper-status This command shows the operational status of configured notification logs.

COMMAND MODE
Privileged Exec

EXAMPLE

```
Console#show nlm oper-status
Filter Name: A1
Oper-Status: Operational
Console#
```

show snmp notify-filter This command displays the configured notification logs.

COMMAND MODE
Privileged Exec

EXAMPLE

This example displays the configured notification logs and associated target hosts.

```
Console#show snmp notify-filter
Filter profile name      IP address
-----
A1                      10.1.19.23
Console#
```

Additional Trap Commands

memory This command sets an SNMP trap based on configured thresholds for memory utilization. Use the **no** form to restore the default setting.

SYNTAX

memory {**rising** *rising-threshold* | **falling** *falling-threshold*}

no memory {**rising** | **falling**}

rising-threshold - Rising threshold for memory utilization alarm expressed in percentage. (Range: 1-100)

falling-threshold - Falling threshold for memory utilization alarm expressed in percentage. (Range: 1-100)

DEFAULT SETTING

Rising Threshold: 90%
Falling Threshold: 70%

COMMAND MODE

Global Configuration

COMMAND USAGE

Once the rising alarm threshold is exceeded, utilization must drop beneath the falling threshold before the alarm is terminated, and then exceed the rising threshold again before another alarm is triggered.

EXAMPLE

```
Console(config)#memory rising 80
Console(config)#memory falling 60
Console#
```

RELATED COMMANDS

[show memory \(728\)](#)

process cpu This command sets an SNMP trap based on configured thresholds for CPU utilization. Use the no form to restore the default setting.

SYNTAX

process cpu {**rising** *rising-threshold* | **falling** *falling-threshold*}

no process cpu {**rising** | **falling**}

rising-threshold - Rising threshold for CPU utilization alarm expressed in percentage. (Range: 1-100)

falling-threshold - Falling threshold for CPU utilization alarm expressed in percentage. (Range: 1-100)

DEFAULT SETTING

Rising Threshold: 90%

Falling Threshold: 70%

COMMAND MODE

Global Configuration

COMMAND USAGE

Once the rising alarm threshold is exceeded, utilization must drop beneath the falling threshold before the alarm is terminated, and then exceed the rising threshold again before another alarm is triggered.

EXAMPLE

```
Console(config)#process cpu rising 80
Console(config)#process cpu falling 60
Console#
```

RELATED COMMANDS

[show process cpu \(729\)](#)

Remote Monitoring allows a remote device to collect information or respond to specified events on an independent basis. This switch is an RMON-capable device which can independently perform a wide range of tasks, significantly reducing network management traffic. It can continuously run diagnostics and log information on network performance. If an event is triggered, it can automatically notify the network administrator of a failure and provide historical information about the event. If it cannot connect to the management agent, it will continue to perform any specified tasks and pass data back to the management station the next time it is contacted.

This switch supports mini-RMON, which consists of the Statistics, History, Event and Alarm groups. When RMON is enabled, the system gradually builds up information about its physical interfaces, storing this information in the relevant RMON database group. A management agent then periodically communicates with the switch using the SNMP protocol. However, if the switch encounters a critical event, it can automatically send a trap message to the management agent which can then respond to the event if so configured.

Table 74: RMON Commands

Command	Function	Mode
<code>rmon alarm</code>	Sets threshold bounds for a monitored variable	GC
<code>rmon event</code>	Creates a response event for an alarm	GC
<code>rmon collection history</code>	Periodically samples statistics	IC
<code>rmon collection rmon1</code>	Enables statistics collection	IC
<code>show rmon alarms</code>	Shows the settings for all configured alarms	PE
<code>show rmon events</code>	Shows the settings for all configured events	PE
<code>show rmon history</code>	Shows the sampling parameters for each entry	PE
<code>show rmon statistics</code>	Shows the collected statistics	PE

rmon alarm This command sets threshold bounds for a monitored variable. Use the **no** form to remove an alarm.

SYNTAX

```
rmon alarm index variable interval {absolute | delta}
rising-threshold threshold [event-index]
falling-threshold threshold [event-index]
[owner name]
```

no rmon alarm *index*

index – Index to this entry. (Range: 1-65535)

variable – The object identifier of the MIB variable to be sampled. Only variables of the type etherStatsEntry.n.n may be sampled. Note that etherStatsEntry.n uniquely defines the MIB variable, and etherStatsEntry.n.n defines the MIB variable, plus the etherStatsIndex. For example, 1.3.6.1.2.1.16.1.1.1.6.1 denotes etherStatsBroadcastPkts, plus the etherStatsIndex of 1.

interval – The polling interval. (Range: 1-31622400 seconds)

absolute – The variable is compared directly to the thresholds at the end of the sampling period.

delta – The last sample is subtracted from the current value and the difference is then compared to the thresholds.

threshold – An alarm threshold for the sampled variable. (Range: 0-2147483647)

event-index – The index of the event to use if an alarm is triggered. If there is no corresponding entry in the event control table, then no event will be generated. (Range: 0-65535)

name – Name of the person who created this entry. (Range: 1-127 characters)

DEFAULT SETTING

1.3.6.1.2.1.16.1.1.1.6.1 - 1.3.6.1.2.1.16.1.1.1.6.28/52

Taking delta samples every 30 seconds,

Rising threshold is 892800, assigned to event 0

Falling threshold is 446400, assigned to event 0

COMMAND MODE

Global Configuration

COMMAND USAGE

- ◆ If an event is already defined for an index, the entry must be deleted before any changes can be made with this command.
- ◆ If the current value is greater than or equal to the rising threshold, and the last sample value was less than this threshold, then an alarm will be generated. After a rising event has been generated, another such event will not be generated until the sampled value has fallen below the rising threshold, reaches the falling threshold, and again moves back up to the rising threshold.

- ◆ If the current value is less than or equal to the falling threshold, and the last sample value was greater than this threshold, then an alarm will be generated. After a falling event has been generated, another such event will not be generated until the sampled value has risen above the falling threshold, reaches the rising threshold, and again moves back down to the failing threshold.

EXAMPLE

```
Console(config)#rmon alarm 1 1 1.3.6.1.2.1.16.1.1.1.6.1 15 delta
  rising-threshold 100 1 falling-threshold 30 1 owner mike
Console(config)#
```

rmon event This command creates a response event for an alarm. Use the **no** form to remove an event.

SYNTAX

rmon event *index* [**log**] | [**trap** *community*] | [**description** *string*] | [**owner** *name*]

no rmon event *index*

index – Index to this entry. (Range: 1-65535)

log – Generates an RMON log entry when the event is triggered. Log messages are processed based on the current configuration settings for event logging (see ["Event Logging" on page 759](#)).

trap – Sends a trap message to all configured trap managers (see the [snmp-server host](#) command).

community – A password-like community string sent with the trap operation to SNMP v1 and v2c hosts. Although this string can be set using the rmon event command by itself, it is recommended that the string be defined using the [snmp-server community](#) command prior to using the rmon event command. (Range: 1-127 characters)

string – A comment that describes this event. (Range: 1-127 characters)

name – Name of the person who created this entry. (Range: 1-127 characters)

DEFAULT SETTING

None

COMMAND MODE

Global Configuration

COMMAND USAGE

- ◆ If an event is already defined for an index, the entry must be deleted before any changes can be made with this command.

- ◆ The specified events determine the action to take when an alarm triggers this event. The response to an alarm can include logging the alarm or sending a message to a trap manager.

EXAMPLE

```
Console(config)#rmon event 2 log description urgent owner mike
Console(config)#
```

rmon collection history This command periodically samples statistics on a physical interface. Use the no form to disable periodic sampling.

SYNTAX

```
rmon collection history controlEntry index
[buckets number [interval seconds]] |
[interval seconds] |
[owner name [buckets number [interval seconds]]]
```

```
no rmon collection history controlEntry index
```

index – Index to this entry. (Range: 1-65535)

number – The number of buckets requested for this entry. (Range: 1-65536)

seconds – The polling interval. (Range: 1-3600 seconds)

name – Name of the person who created this entry. (Range: 1-127 characters)

DEFAULT SETTING

1.3.6.1.2.1.16.1.1.1.6.1 - 1.3.6.1.2.1.16.1.1.1.6.28/52

Buckets: 50

Interval: 30 seconds for even numbered entries,
1800 seconds for odd numbered entries

COMMAND MODE

Interface Configuration (Ethernet)

COMMAND USAGE

- ◆ By default, each index number equates to a port on the switch, but can be changed to any number not currently in use.
- ◆ If periodic sampling is already enabled on an interface, the entry must be deleted before any changes can be made with this command.
- ◆ The information collected for each sample includes:
input octets, packets, broadcast packets, multicast packets, undersize packets, oversize packets, fragments, jabbers, CRC alignment errors, collisions, drop events, and network utilization.
- ◆ The switch reserves two controlEntry index entries for each port. If a default index entry is re-assigned to another port by this command, the

`show running-config` command will display a message indicating that this index is not available for the port to which is normally assigned.

For example, if control entry 15 is assigned to port 5 as shown below, the `show running-config` command will indicate that this entry is not available for port 8.

```
Console(config)#interface ethernet 1/5
Console(config-if)#rmon collection history controlEntry 15
Console(config-if)#end
Console#show running-config
!
interface ethernet 1/5
  rmon collection history controlEntry 15 buckets 50 interval 1800
  ...
interface ethernet 1/8
  no rmon collection history controlEntry 15
```

EXAMPLE

```
Console(config)#interface ethernet 1/1
Console(config-if)#rmon collection history controlentry 21 owner mike buckets
  24 interval 60 owner mike
Console(config-if)#
```

rmon collection rmon1 This command enables the collection of statistics on a physical interface. Use the `no` form to disable statistics collection.

SYNTAX

rmon collection rmon1 controlEntry *index* [*owner name*]

no rmon collection rmon1 controlEntry *index*

index – Index to this entry. (Range: 1-65535)

name – Name of the person who created this entry. (Range: 1-127 characters)

DEFAULT SETTING

Enabled

COMMAND MODE

Interface Configuration (Ethernet)

COMMAND USAGE

- ◆ By default, each index number equates to a port on the switch, but can be changed to any number not currently in use.
- ◆ If statistics collection is already enabled on an interface, the entry must be deleted before any changes can be made with this command.
- ◆ The information collected for each entry includes:
 - input octets, packets, broadcast packets, multicast packets, undersize packets, oversize packets, fragments, jabbers, CRC alignment errors, collisions, drop events, and packets of specified lengths

EXAMPLE

```

Console(config)#interface ethernet 1/1
Console(config-if)#rmon collection rmon1 controlEntry 1 owner mike
Console(config-if)#

```

show rmon alarms This command shows the settings for all configured alarms.

COMMAND MODE

Privileged Exec

EXAMPLE

```

Console#show rmon alarms
Alarm 1 is valid, owned by
Monitors 1.3.6.1.2.1.16.1.1.1.6.1 every 30 seconds
Taking delta samples, last value was 0
Rising threshold is 892800, assigned to event 0
Falling threshold is 446400, assigned to event 0
:

```

show rmon events This command shows the settings for all configured events.

COMMAND MODE

Privileged Exec

EXAMPLE

```

Console#show rmon events
Event 2 is valid, owned by mike
Description is urgent
Event firing causes log and trap to community , last fired 00:00:00
Console#

```

show rmon history This command shows the sampling parameters configured for each entry in the history group.

COMMAND MODE

Privileged Exec

EXAMPLE

```

Console#show rmon history
Entry 1 is valid, and owned by
Monitors 1.3.6.1.2.1.2.2.1.1.1 every 1800 seconds
Requested # of time intervals, ie buckets, is 8
Granted # of time intervals, ie buckets, is 8
Sample # 1 began measuring at 00:00:01
Received 77671 octets, 1077 packets,
61 broadcast and 978 multicast packets,

```



```

0 undersized and 0 oversized packets,
0 fragments and 0 jabbers packets,
0 CRC alignment errors and 0 collisions.
# of dropped packet events is 0
Network utilization is estimated at 0
:

```

show rmon statistics This command shows the information collected for all configured entries in the statistics group.

COMMAND MODE
Privileged Exec

EXAMPLE

```

Console#show rmon statistics
Interface 1 is valid, and owned by
Monitors 1.3.6.1.2.1.2.2.1.1.1 which has
Received 164289 octets, 2372 packets,
120 broadcast and 2211 multicast packets,
0 undersized and 0 oversized packets,
0 fragments and 0 jabbers,
0 CRC alignment errors and 0 collisions.
# of dropped packet events (due to lack of resources): 0
# of packets received of length (in octets):
64: 2245, 65-127: 87, 128-255: 31,
256-511: 5, 512-1023: 2, 1024-1518: 2
:

```

You can configure this switch to authenticate users logging into the system for management access using local or remote authentication methods. Port-based authentication using IEEE 802.1X can also be configured to control either management access to the uplink ports or client access²¹ to the data ports.

Table 75: Authentication Commands

Command Group	Function
User Accounts and Privilege Levels	Configures the basic user names and passwords for management access, and assigns a privilege level to specified command groups or individual commands
Authentication Sequence	Defines logon authentication method and precedence
RADIUS Client	Configures settings for authentication via a RADIUS server
TACACS+ Client	Configures settings for authentication via a TACACS+ server
AAA	Configures authentication, authorization, and accounting for network access
Web Server	Enables management access via a web browser
Telnet Server	Enables management access via Telnet
Secure Shell	Provides secure replacement for Telnet
802.1X Port Authentication	Configures host authentication on specific ports using 802.1X
Management IP Filter	Configures IP addresses that are allowed management access
PPPoE Intermediate Agent	Configures relay parameters required for sending authentication messages between a client and broadband remote access servers

21. For other methods of controlling client access, see "[General Security Measures](#)" on [page 889](#).

USER ACCOUNTS AND PRIVILEGE LEVELS

The basic commands required for management access and assigning command privilege levels are listed in this section. This switch also includes other options for password checking via the console or a Telnet connection (page 748), user authentication via a remote authentication server (page 823), and host access authentication for specific ports (page 862).

Table 76: User Access Commands

Command	Function	Mode
<code>enable password</code>	Sets a password to control access to the Privileged Exec level	GC
<code>username</code>	Establishes a user name-based authentication system at login	GC
<code>privilege</code>	Assigns a privilege level to specified command groups or individual commands	GC
<code>show privilege</code>	Shows the privilege level for the current user, or the privilege level for commands modified by the <code>privilege</code> command	PE

enable password After initially logging onto the system, you should set the Privileged Exec password. Remember to record it in a safe place. This command controls access to the Privileged Exec level from the Normal Exec level. Use the **no** form to reset the default password.

SYNTAX

enable password [**level** *level*] {**0** | **7**} *password*

no enable password [**level** *level*]

level *level* - Sets the command access privileges. (Range: 0-15)

Level 0, 8 and 15 are designed for users (guest), managers (network maintenance), and administrators (top-level access). The other levels can be used to configured specialized access profiles.

Level 0-7 provide the same default access privileges, all within Normal Exec mode under the "Console>" command prompt.

Level 8-14 provide the same default access privileges, including additional commands in Normal Exec mode, and a subset of commands in Privileged Exec mode under the "Console#" command prompt.

Level 15 provides full access to all commands.

The privilege level associated with any command can be changed using the `privilege` command.

{**0** | **7**} - 0 means plain password, 7 means encrypted password.

password - Password for this privilege level. (Maximum length: 32 characters plain text or encrypted, case sensitive)

DEFAULT SETTING

The default is level 15.
The default password is "super"

COMMAND MODE

Global Configuration

COMMAND USAGE

- ◆ You cannot set a null password. You will have to enter a password to change the command mode from Normal Exec to Privileged Exec with the `enable` command.
- ◆ The encrypted password is required for compatibility with legacy password settings (i.e., plain text or encrypted) when reading the configuration file during system bootup or when downloading the configuration file from an FTP server. There is no need for you to manually configure encrypted passwords.

EXAMPLE

```
Console(config)#enable password level 15 0 admin
Console(config)#
```

RELATED COMMANDS

[enable \(711\)](#)
[authentication enable \(828\)](#)

username This command adds named users, requires authentication at login, specifies or changes a user's password (or specify that no password is required), or specifies or changes a user's access level. Use the **no** form to remove a user name.

SYNTAX

username *name* {**access-level** *level* | **nopassword** | **password** {**0** | **7**} *password*}

no username *name*

name - The name of the user. (Maximum length: 32 characters, case sensitive. Maximum users: 16)

The device has two predefined users, **guest** which is assigned privilege level **0** (Normal Exec), and **admin** which is assigned privilege level 15 and has full access to all commands under both Normal Exec and Privileged Exec command modes.

access-level *level* - Specifies command access privileges. (Range: 0-15)

Level 0, 8 and 15 are designed for users (guest), managers (network maintenance), and administrators (top-level access). The other levels can be used to configured specialized access profiles.

Level 0-7 provide the same default access privileges, all within Normal Exec mode under the "Console>" command prompt.

Level 8-14 provide the same default access privileges, including additional commands in Normal Exec mode, and a subset of commands in Privileged Exec mode under the "Console#" command prompt.

Level 15 provides full access to all commands.

The privilege level associated with any command can be changed using the `privilege` command.

Any privilege level can access all of the commands assigned to lower privilege levels. For example, privilege level 8 can access all commands assigned to privilege levels 7-0 according to default settings, and to any other commands assigned to levels 7-0 using the `privilege` command.

nopassword - No password is required for this user to log in.

{0 | 7} - 0 means plain password, 7 means encrypted password.

password *password* - The authentication password for the user. (Maximum length: 32 characters plain text or encrypted, case sensitive)

DEFAULT SETTING

The default access level is Normal Exec.

The factory defaults for the user names and passwords are:

Table 77: Default Login Settings

username	access-level	password
guest	0	guest
admin	15	admin

COMMAND MODE

Global Configuration

COMMAND USAGE

The encrypted password is required for compatibility with legacy password settings (i.e., plain text or encrypted) when reading the configuration file during system bootup or when downloading the configuration file from an FTP server. There is no need for you to manually configure encrypted passwords.

EXAMPLE

This example shows how to set the access level and password for a user.

```
Console(config)#username bob access-level 15
Console(config)#username bob password 0 smith
Console(config)#
```

privilege This command assigns a privilege level to specified command groups or individual commands. Use the **no** form to restore the default setting.

SYNTAX

privilege *mode* [**all**] **level** *level* *command*

no privilege *mode* [**all**] *command*

mode - The configuration mode containing the specified *command*. (See "Understanding Command Modes" on page 702 and "Configuration Commands" on page 703.)

all - Modifies the privilege level for all subcommands under the specified *command*.

level *level* - Specifies the privilege level for the specified *command*. Refer to the default settings described for the access level parameter under the `username` command. (Range: 0-15)

command - Specifies any command contained within the specified *mode*.

DEFAULT SETTING

Privilege level 0 provides access to a limited number of the commands which display the current status of the switch, as well as several database clear and reset functions. Level 8 provides access to all display status and configuration commands, except for those controlling various authentication and security features. Level 15 provides full access to all commands.

COMMAND MODE

Global Configuration

EXAMPLE

This example sets the privilege level for the ping command to Privileged Exec.

```
Console(config)#privilege exec level 15 ping
Console(config)#
```

show privilege This command shows the privilege level for the current user, or the privilege level for commands modified by the `privilege` command.

SYNTAX

show privilege [**command**]

command - Displays the privilege level for all commands modified by the `privilege` command.

COMMAND MODE

Privileged Exec

EXAMPLE

This example shows the privilege level for any command modified by the `privilege` command.

```
Console#show privilege command
privilege line all level 0 accounting
privilege exec level 15 ping
Console(config)#
```

AUTHENTICATION SEQUENCE

Three authentication methods can be specified to authenticate users logging into the system for management access. The commands in this section can be used to define the authentication method and sequence.

Table 78: Authentication Sequence Commands

Command	Function	Mode
<code>authentication enable</code>	Defines the authentication method and precedence for command mode change	GC
<code>authentication login</code>	Defines logon authentication method and precedence	GC

authentication enable

This command defines the authentication method and precedence to use when changing from Exec command mode to Privileged Exec command mode with the `enable` command. Use the **no** form to restore the default.

SYNTAX

authentication enable {[local] [radius] [tacacs]}

no authentication enable

local - Use local password only.

radius - Use RADIUS server password only.

tacacs - Use TACACS server password.

DEFAULT SETTING

Local

COMMAND MODE

Global Configuration

COMMAND USAGE

- ◆ RADIUS uses UDP while TACACS+ uses TCP. UDP only offers best effort delivery, while TCP offers a connection-oriented transport. Also, note that RADIUS encrypts only the password in the access-request packet from the client to the server, while TACACS+ encrypts the entire body of the packet.

- ◆ RADIUS and TACACS+ logon authentication assigns a specific privilege level for each user name and password pair. The user name, password, and privilege level must be configured on the authentication server.
- ◆ You can specify three authentication methods in a single command to indicate the authentication sequence. For example, if you enter "**authentication enable radius tacacs local**," the user name and password on the RADIUS server is verified first. If the RADIUS server is not available, then authentication is attempted on the TACACS+ server. If the TACACS+ server is not available, the local user name and password is checked.

EXAMPLE

```
Console(config)#authentication enable radius
Console(config)#
```

RELATED COMMANDS

enable password - sets the password for changing command modes ([824](#))

authentication login This command defines the login authentication method and precedence. Use the **no** form to restore the default.

SYNTAX

authentication login {[**local**] [**radius**] [**tacacs**]}

no authentication login

local - Use local password.

radius - Use RADIUS server password.

tacacs - Use TACACS server password.

DEFAULT SETTING

Local

COMMAND MODE

Global Configuration

COMMAND USAGE

- ◆ RADIUS uses UDP while TACACS+ uses TCP. UDP only offers best effort delivery, while TCP offers a connection-oriented transport. Also, note that RADIUS encrypts only the password in the access-request packet from the client to the server, while TACACS+ encrypts the entire body of the packet.
- ◆ RADIUS and TACACS+ logon authentication assigns a specific privilege level for each user name and password pair. The user name, password, and privilege level must be configured on the authentication server.
- ◆ You can specify three authentication methods in a single command to indicate the authentication sequence. For example, if you enter

“authentication login radius tacacs local,” the user name and password on the RADIUS server is verified first. If the RADIUS server is not available, then authentication is attempted on the TACACS+ server. If the TACACS+ server is not available, the local user name and password is checked.

EXAMPLE

```
Console(config)#authentication login radius
Console(config)#
```

RELATED COMMANDS

[username](#) - for setting the local user names and passwords (825)

RADIUS CLIENT

Remote Authentication Dial-in User Service (RADIUS) is a logon authentication protocol that uses software running on a central server to control access to RADIUS-aware devices on the network. An authentication server contains a database of multiple user name/password pairs with associated privilege levels for each user or group that require management access to a switch.

Table 79: RADIUS Client Commands

Command	Function	Mode
radius-server acct-port	Sets the RADIUS server network port	GC
radius-server auth-port	Sets the RADIUS server network port	GC
radius-server host	Specifies the RADIUS server	GC
radius-server key	Sets the RADIUS encryption key	GC
radius-server retransmit	Sets the number of retries	GC
radius-server timeout	Sets the interval between sending authentication requests	GC
show radius-server	Shows the current RADIUS settings	PE

radius-server acct-port This command sets the RADIUS server network port for accounting messages. Use the **no** form to restore the default.

SYNTAX

radius-server acct-port *port-number*

no radius-server acct-port

port-number - RADIUS server UDP port used for accounting messages. (Range: 1-65535)

DEFAULT SETTING

1813

COMMAND MODE

Global Configuration

EXAMPLE

```
Console(config)#radius-server acct-port 181
Console(config)#
```

radius-server auth-port This command sets the RADIUS server network port. Use the **no** form to restore the default.

SYNTAX

radius-server auth-port *port-number*

no radius-server auth-port

port-number - RADIUS server UDP port used for authentication messages. (Range: 1-65535)

DEFAULT SETTING

1812

COMMAND MODE

Global Configuration

EXAMPLE

```
Console(config)#radius-server auth-port 181
Console(config)#
```

radius-server host This command specifies primary and backup RADIUS servers, and authentication and accounting parameters that apply to each server. Use the **no** form to remove a specified server, or to restore the default values.

SYNTAX

[no] radius-server *index* **host** *host-ip-address* [**acct-port** *acct-port*] [**auth-port** *auth-port*] [**key** *key*] [**retransmit** *retransmit*] [**timeout** *timeout*]

index - Allows you to specify up to five servers. These servers are queried in sequence until a server responds or the retransmit period expires.

host-ip-address - IP address of server.

acct-port - RADIUS server UDP port used for accounting messages. (Range: 1-65535)

auth-port - RADIUS server UDP port used for authentication messages. (Range: 1-65535)

key - Encryption key used to authenticate logon access for client. Enclose any string containing blank spaces in double quotes. (Maximum length: 48 characters)

retransmit - Number of times the switch will try to authenticate logon access via the RADIUS server. (Range: 1-30)

timeout - Number of seconds the switch waits for a reply before resending a request. (Range: 1-65535)

DEFAULT SETTING

auth-port - 1812
acct-port - 1813
timeout - 5 seconds
retransmit - 2

COMMAND MODE

Global Configuration

EXAMPLE

```
Console(config)#radius-server 1 host 192.168.1.20 acct-port 181 timeout 10  
retransmit 5 key green  
Console(config)#
```

radius-server key This command sets the RADIUS encryption key. Use the **no** form to restore the default.

SYNTAX

radius-server key *key-string*

no radius-server key

key-string - Encryption key used to authenticate logon access for client. Enclose any string containing blank spaces in double quotes. (Maximum length: 48 characters)

DEFAULT SETTING

None

COMMAND MODE

Global Configuration

EXAMPLE

```
Console(config)#radius-server key green  
Console(config)#
```

radius-server retransmit This command sets the number of retries. Use the **no** form to restore the default.

SYNTAX

radius-server retransmit *number-of-retries*

no radius-server retransmit

number-of-retries - Number of times the switch will try to authenticate logon access via the RADIUS server. (Range: 1 - 30)

DEFAULT SETTING

2

COMMAND MODE

Global Configuration

EXAMPLE

```
Console(config)#radius-server retransmit 5
Console(config)#
```

radius-server timeout This command sets the interval between transmitting authentication requests to the RADIUS server. Use the **no** form to restore the default.

SYNTAX

radius-server timeout *number-of-seconds*

no radius-server timeout

number-of-seconds - Number of seconds the switch waits for a reply before resending a request. (Range: 1-65535)

DEFAULT SETTING

5

COMMAND MODE

Global Configuration

EXAMPLE

```
Console(config)#radius-server timeout 10
Console(config)#
```

show radius-server This command displays the current settings for the RADIUS server.

DEFAULT SETTING

None

COMMAND MODE

Privileged Exec

EXAMPLE

```
Console#show radius-server

Remote RADIUS Server Configuration:

Global Settings:
  Authentication Port Number : 1812
  Accounting Port Number   : 1813
  Retransmit Times         : 2
  Request Timeout          : 5

Server 1:
  Server IP Address        : 192.168.1.1
  Authentication Port Number : 1812
  Accounting Port Number   : 1813
  Retransmit Times         : 2
  Request Timeout          : 5

RADIUS Server Group:
Group Name      Member Index
-----
radius          1
Console#
```

TACACS+ CLIENT

Terminal Access Controller Access Control System (TACACS+) is a logon authentication protocol that uses software running on a central server to control access to TACACS-aware devices on the network. An authentication server contains a database of multiple user name/password pairs with associated privilege levels for each user or group that require management access to a switch.

Table 80: TACACS+ Client Commands

Command	Function	Mode
tacacs-server host	Specifies the TACACS+ server and optional parameters	GC
tacacs-server key	Sets the TACACS+ encryption key	GC
tacacs-server port	Specifies the TACACS+ server network port	GC
tacacs-server retransmit	Sets the number of retries	GC
tacacs-server timeout	Sets the interval between sending authentication requests	GC
show tacacs-server	Shows the current TACACS+ settings	GC

tacacs-server host This command specifies the TACACS+ server and other optional parameters. Use the **no** form to remove the server, or to restore the default values.

SYNTAX

tacacs-server *index* **host** *host-ip-address* [**key** *key*]
[**port** *port-number*] [**retransmit** *retransmit*] [**timeout** *timeout*]

no tacacs-server *index*

index - The index for this server. (Range: 1)

host-ip-address - IP address of a TACACS+ server.

key - Encryption key used to authenticate logon access for the client. Enclose any string containing blank spaces in double quotes. (Maximum length: 48 characters)

port-number - TACACS+ server TCP port used for authentication messages. (Range: 1-65535)

retransmit - Number of times the switch will try to authenticate logon access via the TACACS+ server. (Range: 1-30)

timeout - Number of seconds the switch waits for a reply before resending a request. (Range: 1-540)

DEFAULT SETTING

authentication port - 49

timeout - 5 seconds

retransmit - 2

COMMAND MODE

Global Configuration

EXAMPLE

```
Console(config)#tacacs-server 1 host 192.168.1.25 port 181 timeout 10
retransmit 5 key green
Console(config)#
```

tacacs-server key This command sets the TACACS+ encryption key. Use the **no** form to restore the default.

SYNTAX

tacacs-server key *key-string*

no tacacs-server key

key-string - Encryption key used to authenticate logon access for the client. Enclose any string containing blank spaces in double quotes. (Maximum length: 48 characters)

DEFAULT SETTING

None

COMMAND MODE
Global Configuration

EXAMPLE

```
Console(config)#tacacs-server key green  
Console(config)#
```

tacacs-server port This command specifies the TACACS+ server network port. Use the **no** form to restore the default.

SYNTAX

tacacs-server port *port-number*

no tacacs-server port

port-number - TACACS+ server TCP port used for authentication messages. (Range: 1-65535)

DEFAULT SETTING

49

COMMAND MODE
Global Configuration

EXAMPLE

```
Console(config)#tacacs-server port 181  
Console(config)#
```

tacacs-server retransmit This command sets the number of retries. Use the **no** form to restore the default.

SYNTAX

tacacs-server retransmit *number-of-retries*

no tacacs-server retransmit

number-of-retries - Number of times the switch will try to authenticate logon access via the TACACS+ server. (Range: 1 - 30)

DEFAULT SETTING

2

COMMAND MODE
Global Configuration

EXAMPLE

```
Console(config)#tacacs-server retransmit 5
Console(config)#
```

tacacs-server timeout This command sets the interval between transmitting authentication requests to the TACACS+ server. Use the **no** form to restore the default.

SYNTAX

tacacs-server timeout *number-of-seconds*

no tacacs-server timeout

number-of-seconds - Number of seconds the switch waits for a reply before resending a request. (Range: 1-540)

DEFAULT SETTING

5

COMMAND MODE

Global Configuration

EXAMPLE

```
Console(config)#tacacs-server timeout 10
Console(config)#
```

show tacacs-server This command displays the current settings for the TACACS+ server.

DEFAULT SETTING

None

COMMAND MODE

Privileged Exec

EXAMPLE

```
Console#show tacacs-server

Remote TACACS+ Server Configuration:

Global Settings:
  Server Port Number : 49
  Retransmit Times   : 2
  Timeout            : 5

Server 1:
  Server IP Address  : 192.168.1.25
  Server Port Number : 181
  Retransmit Times   : 2
  Timeout            : 4
```

```
TACACS+ Server Group:
Group Name          Member Index
-----
tacacs+             1

Console#
```

AAA

The Authentication, Authorization, and Accounting (AAA) feature provides the main framework for configuring access control on the switch. The AAA functions require the use of configured RADIUS or TACACS+ servers in the network.

Table 81: AAA Commands

Command	Function	Mode
aaa accounting commands	Enables accounting of Exec mode commands	GC
aaa accounting dot1x	Enables accounting of 802.1X services	GC
aaa accounting exec	Enables accounting of Exec services	GC
aaa accounting update	Enables periodoc updates to be sent to the accounting server	GC
aaa authorization exec	Enables authorization of Exec sessions	GC
aaa group server	Groups security servers in to defined lists	GC
server	Configures the IP address of a server in a group list	SG
accounting dot1x	Applies an accounting method to an interface for 802.1X service requests	IC
accounting commands	Applies an accounting method to CLI commands entered by a user	Line
accounting exec	Applies an accounting method to local console, Telnet or SSH connections	Line
authorization exec	Applies an authorization method to local console, Telnet or SSH connections	Line
show accounting	Displays all accounting information	PE

aaa accounting commands This command enables the accounting of Exec mode commands. Use the **no** form to disable the accounting service.

SYNTAX

aaa accounting commands *level* {**default** | *method-name*}
start-stop group {**tacacs+** | *server-group*}

no aaa accounting commands *level* {**default** | *method-name*}

level - The privilege level for executing commands. (Range: 0-15)

default - Specifies the default accounting method for service requests.

method-name - Specifies an accounting method for service requests. (Range: 1-64 characters)

start-stop - Records accounting from starting point and stopping point.

group - Specifies the server group to use.

tacacs+ - Specifies all TACACS+ hosts configure with the `tacacs-server host` command.

server-group - Specifies the name of a server group configured with the `aaa group server` command. (Range: 1-64 characters)

DEFAULT SETTING

Accounting is not enabled

No servers are specified

COMMAND MODE

Global Configuration

COMMAND USAGE

- ◆ The accounting of Exec mode commands is only supported by TACACS+ servers.
- ◆ Note that the **default** and *method-name* fields are only used to describe the accounting method(s) configured on the specified TACACS+ server, and do not actually send any information to the server about the methods to use.

EXAMPLE

```
Console(config)#aaa accounting commands 15 default start-stop group tacacs+
Console(config)#
```

aaa accounting dot1x This command enables the accounting of requested 802.1X services for network access. Use the **no** form to disable the accounting service.

SYNTAX

```
aaa accounting dot1x {default | method-name}
start-stop group {radius | tacacs+ | server-group}
```

```
no aaa accounting dot1x {default | method-name}
```

default - Specifies the default accounting method for service requests.

method-name - Specifies an accounting method for service requests. (Range: 1-64 characters)

start-stop - Records accounting from starting point and stopping point.

group - Specifies the server group to use.

radius - Specifies all RADIUS hosts configure with the [radius-server host](#) command.

tacacs+ - Specifies all TACACS+ hosts configure with the [tacacs-server host](#) command.

server-group - Specifies the name of a server group configured with the [aaa group server](#) command. (Range: 1-64 characters)

DEFAULT SETTING

Accounting is not enabled
No servers are specified

COMMAND MODE

Global Configuration

COMMAND USAGE

Note that the **default** and *method-name* fields are only used to describe the accounting method(s) configured on the specified RADIUS or TACACS+ servers, and do not actually send any information to the servers about the methods to use.

EXAMPLE

```
Console(config)#aaa accounting dot1x default start-stop group radius
Console(config)#
```

aaa accounting exec This command enables the accounting of requested Exec services for network access. Use the **no** form to disable the accounting service.

SYNTAX

```
aaa accounting exec {default | method-name}
start-stop group {radius | tacacs+ | server-group}
```

```
no aaa accounting exec {default | method-name}
```

default - Specifies the default accounting method for service requests.

method-name - Specifies an accounting method for service requests. (Range: 1-64 characters)

start-stop - Records accounting from starting point and stopping point.

group - Specifies the server group to use.

radius - Specifies all RADIUS hosts configure with the [radius-server host](#) command.

tacacs+ - Specifies all TACACS+ hosts configure with the [tacacs-server host](#) command.

server-group - Specifies the name of a server group configured with the `aaa group server` command. (Range: 1-64 characters)

DEFAULT SETTING

Accounting is not enabled
No servers are specified

COMMAND MODE

Global Configuration

COMMAND USAGE

- ◆ This command runs accounting for Exec service requests for the local console and Telnet connections.
- ◆ Note that the **default** and *method-name* fields are only used to describe the accounting method(s) configured on the specified RADIUS or TACACS+ servers, and do not actually send any information to the servers about the methods to use.

EXAMPLE

```
Console(config)#aaa accounting exec default start-stop group tacacs+
Console(config)#
```

aaa accounting update This command enables the sending of periodic updates to the accounting server. Use the **no** form to restore the default setting.

SYNTAX

aaa accounting update [**periodic** *interval*]

no aaa accounting update

interval - Sends an interim accounting record to the server at this interval. (Range: 1-2147483647 minutes)

DEFAULT SETTING

1 minute

COMMAND MODE

Global Configuration

COMMAND USAGE

- ◆ When accounting updates are enabled, the switch issues periodic interim accounting records for all users on the system.
- ◆ Using the command without specifying an interim interval enables updates, but does not change the current interval setting.

EXAMPLE

```
Console(config)#aaa accounting update periodic 30  
Console(config)#
```

aaa authorization exec This command enables the authorization for Exec access. Use the **no** form to disable the authorization service.

SYNTAX

```
aaa authorization exec {default | method-name}  
                  group {tacacs+ | server-group}
```

```
no aaa authorization exec {default | method-name}
```

default - Specifies the default authorization method for Exec access.

method-name - Specifies an authorization method for Exec access. (Range: 1-64 characters)

group - Specifies the server group to use.

tacacs+ - Specifies all TACACS+ hosts configured with the [tacacs-server host](#) command.

server-group - Specifies the name of a server group configured with the [aaa group server](#) command. (Range: 1-64 characters)

DEFAULT SETTING

Authorization is not enabled
No servers are specified

COMMAND MODE

Global Configuration

COMMAND USAGE

- ◆ This command performs authorization to determine if a user is allowed to run an Exec shell.
- ◆ AAA authentication must be enabled before authorization is enabled.
- ◆ If this command is issued without a specified named method, the default method list is applied to all interfaces or lines (where this authorization type applies), except those that have a named method explicitly defined.

EXAMPLE

```
Console(config)#aaa authorization exec default group tacacs+  
Console(config)#
```

aaa group server Use this command to name a group of security server hosts. To remove a server group from the configuration list, enter the **no** form of this command.

SYNTAX

[no] aaa group server {radius | tacacs+} group-name

radius - Defines a RADIUS server group.

tacacs+ - Defines a TACACS+ server group.

group-name - A text string that names a security server group.
(Range: 1-64 characters)

DEFAULT SETTING

None

COMMAND MODE

Global Configuration

EXAMPLE

```
Console(config)#aaa group server radius tps
Console(config-sg-radius)#
```

server This command adds a security server to an AAA server group. Use the **no** form to remove the associated server from the group.

SYNTAX

[no] server {index | ip-address}

index - Specifies the server index.
(Range: RADIUS 1-5, TACACS+ 1)

ip-address - Specifies the host IP address of a server.

DEFAULT SETTING

None

COMMAND MODE

Server Group Configuration

COMMAND USAGE

- ◆ When specifying the index for a RADIUS server, that server index must already be defined by the [radius-server host](#) command.
- ◆ When specifying the index for a TACACS+ server, that server index must already be defined by the [tacacs-server host](#) command.

EXAMPLE

```
Console(config)#aaa group server radius tps
Console(config-sg-radius)#server 10.2.68.120
Console(config-sg-radius)#
```

accounting dot1x This command applies an accounting method for 802.1X service requests on an interface. Use the **no** form to disable accounting on the interface.

SYNTAX

accounting dot1x {**default** | *list-name*}

no accounting dot1x

default - Specifies the default method list created with the **aaa accounting dot1x** command.

list-name - Specifies a method list created with the **aaa accounting dot1x** command.

DEFAULT SETTING

None

COMMAND MODE

Interface Configuration

EXAMPLE

```
Console(config)#interface ethernet 1/2
Console(config-if)#accounting dot1x tps
Console(config-if)#
```

accounting commands This command applies an accounting method to entered CLI commands. Use the **no** form to disable accounting for entered CLI commands.

SYNTAX

accounting commands *level* {**default** | *list-name*}

no accounting commands *level*

level - The privilege level for executing commands. (Range: 0-15)

default - Specifies the default method list created with the **aaa accounting commands** command.

list-name - Specifies a method list created with the **aaa accounting commands** command.

DEFAULT SETTING

None

COMMAND MODE
Line Configuration

EXAMPLE

```
Console(config)#line console
Console(config-line)#accounting commands 15 default
Console(config-line)#
```

accounting exec This command applies an accounting method to local console, Telnet or SSH connections. Use the **no** form to disable accounting on the line.

SYNTAX

accounting exec {**default** | *list-name*}

no accounting exec

default - Specifies the default method list created with the [aaa accounting exec](#) command.

list-name - Specifies a method list created with the [aaa accounting exec](#) command.

DEFAULT SETTING

None

COMMAND MODE
Line Configuration

EXAMPLE

```
Console(config)#line console
Console(config-line)#accounting exec tps
Console(config-line)#exit
Console(config)#line vty
Console(config-line)#accounting exec default
Console(config-line)#
```

authorization exec This command applies an authorization method to local console, Telnet or SSH connections. Use the **no** form to disable authorization on the line.

SYNTAX

authorization exec {**default** | *list-name*}

no authorization exec

default - Specifies the default method list created with the [aaa authorization exec](#) command.

list-name - Specifies a method list created with the [aaa authorization exec](#) command.

DEFAULT SETTING

None

COMMAND MODE

Line Configuration

EXAMPLE

```
Console(config)#line console
Console(config-line)#authorization exec tps
Console(config-line)#exit
Console(config)#line vty
Console(config-line)#authorization exec default
Console(config-line)#
```

show accounting This command displays the current accounting settings per function and per port.

SYNTAX

```
show accounting [commands [level]] |
[[dot1x [statistics [username user-name | interface interface]]
| exec [statistics] | statistics]
```

commands - Displays command accounting information.

level - Displays command accounting information for a specifiable command level.

dot1x - Displays dot1x accounting information.

exec - Displays Exec accounting records.

statistics - Displays accounting records.

user-name - Displays accounting records for a specifiable username.

interface

ethernet *unit/port*

unit - Unit identifier. (Range: 1)

port - Port number. (Range: 1-28/52)

DEFAULT SETTING

None

COMMAND MODE

Privileged Exec

EXAMPLE

```
Console#show accounting
Accounting Type: dot1x
Method List   : default
Group List    : radius
```

```

Interface      : Eth 1/1
Method List    : tps
Group List     : radius
Interface      : Eth 1/2

Accounting Type: EXEC
Method List    : default
Group List     : tacacs+
Interface      : vty

Console#

```

WEB SERVER

This section describes commands used to configure web browser management access to the switch.

Table 82: Web Server Commands

Command	Function	Mode
<code>ip http port</code>	Specifies the port to be used by the web browser interface	GC
<code>ip http server</code>	Allows the switch to be monitored or configured from a browser	GC
<code>ip http secure-port</code>	Specifies the UDP port number for HTTPS	GC
<code>ip http secure-server</code>	Enables HTTPS (HTTP/SSL) for encrypted communications	GC



NOTE: Users are automatically logged off of the HTTP server or HTTPS server if no input is detected for 300 seconds.

ip http port This command specifies the TCP port number used by the web browser interface. Use the **no** form to use the default port.

SYNTAX

ip http port *port-number*

no ip http port

port-number - The TCP port to be used by the browser interface.
(Range: 1-65535)

DEFAULT SETTING

80

COMMAND MODE

Global Configuration

EXAMPLE

```
Console(config)#ip http port 769  
Console(config)#
```

RELATED COMMANDS

[ip http server \(848\)](#)
[show system \(732\)](#)

ip http server This command allows this device to be monitored or configured from a browser. Use the **no** form to disable this function.

SYNTAX

[no] ip http server

DEFAULT SETTING

Enabled

COMMAND MODE

Global Configuration

EXAMPLE

```
Console(config)#ip http server  
Console(config)#
```

RELATED COMMANDS

[ip http port \(847\)](#)
[show system \(732\)](#)

ip http secure-port This command specifies the TCP port number used for HTTPS connection to the switch's web interface. Use the **no** form to restore the default port.

SYNTAX

ip http secure-port *port_number*

no ip http secure-port

port_number – The TCP port used for HTTPS. (Range: 1-65535)

DEFAULT SETTING

443

COMMAND MODE

Global Configuration

COMMAND USAGE

- ◆ You cannot configure the HTTP and HTTPS servers to use the same port.
- ◆ If you change the HTTPS port number, clients attempting to connect to the HTTPS server must specify the port number in the URL, in this format: **https://device:port_number**

EXAMPLE

```
Console(config)#ip http secure-port 1000
Console(config)#
```

RELATED COMMANDS

[ip http secure-server \(849\)](#)
[show system \(732\)](#)

**ip http
secure-server**

This command enables the secure hypertext transfer protocol (HTTPS) over the Secure Socket Layer (SSL), providing secure access (i.e., an encrypted connection) to the switch's web interface. Use the **no** form to disable this function.

SYNTAX

[no] ip http secure-server

DEFAULT SETTING

Disabled

COMMAND MODE

Global Configuration

COMMAND USAGE

- ◆ Both HTTP and HTTPS service can be enabled independently on the switch. However, you cannot configure the HTTP and HTTPS servers to use the same UDP port.
- ◆ If you enable HTTPS, you must indicate this in the URL that you specify in your browser: **https://device[:port_number]**
- ◆ When you start HTTPS, the connection is established in this way:
 - The client authenticates the server using the server's digital certificate.
 - The client and server negotiate a set of security protocols to use for the connection.
 - The client and server generate session keys for encrypting and decrypting data.

- ◆ The client and server establish a secure encrypted connection.

A padlock icon should appear in the status bar for Internet Explorer 6, Mozilla Firefox 4, or Google Chrome 29, or more recent versions.

The following web browsers and operating systems currently support HTTPS:

Table 83: HTTPS System Support

Web Browser	Operating System
Internet Explorer 6.x or later	Windows 98, Windows NT (with service pack 6a), Windows 2000, XP, Vista, 7, 8
Mozilla Firefox 4 or later	Windows 2000, XP, Vista, 7, 8, Linux
Google Chrome 29 or later	Windows XP, Vista, 7, 8

- ◆ To specify a secure-site certificate, see “Replacing the Default Secure-site Certificate” on page 342. Also refer to the [copy tftp https-certificate](#) command.
- ◆ Connection to the web interface is not supported for HTTPS using an IPv6 link local address.

EXAMPLE

```
Console(config)#ip http secure-server
Console(config)#
```

RELATED COMMANDS

- [ip http secure-port \(848\)](#)
- [copy tftp https-certificate \(738\)](#)
- [show system \(732\)](#)

TELNET SERVER

This section describes commands used to configure Telnet management access to the switch.

Table 84: Telnet Server Commands

Command	Function	Mode
ip telnet max-sessions	Specifies the maximum number of Telnet sessions that can simultaneously connect to this system	GC
ip telnet port	Specifies the port to be used by the Telnet interface	GC
ip telnet server	Allows the switch to be monitored or configured from Telnet	GC
show ip telnet	Displays configuration settings for the Telnet server	PE



NOTE: This switch also supports a Telnet client function. A Telnet connection can be made from this switch to another device by entering the **telnet** command at the Privileged Exec configuration level.

ip telnet max-sessions

This command specifies the maximum number of Telnet sessions that can simultaneously connect to this system. Use the **no** form to restore the default setting.

SYNTAX

ip telnet max-sessions *session-count*

no ip telnet max-sessions

session-count - The maximum number of allowed Telnet session.
(Range: 0-8)

DEFAULT SETTING

4 sessions

COMMAND MODE

Global Configuration

COMMAND USAGE

A maximum of eight sessions can be concurrently opened for Telnet and Secure Shell (i.e., both Telnet and SSH share a maximum number of four sessions).

EXAMPLE

```
Console(config)#ip telnet max-sessions 1
Console(config)#
```

ip telnet port

This command specifies the TCP port number used by the Telnet interface. Use the **no** form to use the default port.

SYNTAX

ip telnet port *port-number*

no telnet port

port-number - The TCP port number to be used by the browser interface. (Range: 1-65535)

DEFAULT SETTING

23

COMMAND MODE
Global Configuration

EXAMPLE

```
Console(config)#ip telnet port 123  
Console(config)#
```

ip telnet server This command allows this device to be monitored or configured from Telnet. Use the **no** form to disable this function.

SYNTAX
[no] **ip telnet server**

DEFAULT SETTING
Enabled

COMMAND MODE
Global Configuration

EXAMPLE

```
Console(config)#ip telnet server  
Console(config)#
```

show ip telnet This command displays the configuration settings for the Telnet server.

COMMAND MODE
Normal Exec, Privileged Exec

EXAMPLE

```
Console#show ip telnet  
IP Telnet Configuration:  
  
Telnet Status: Enabled  
Telnet Service Port: 23  
Telnet Max Session: 8  
Console#
```

SECURE SHELL

This section describes the commands used to configure the SSH server. Note that you also need to install a SSH client on the management station when using this protocol to configure the switch.



NOTE: The switch supports both SSH Version 1.5 and 2.0 clients.

Table 85: Secure Shell Commands

Command	Function	Mode
<code>ip ssh authentication-retries</code>	Specifies the number of retries allowed by a client	GC
<code>ip ssh server</code>	Enables the SSH server on the switch	GC
<code>ip ssh server-key size</code>	Sets the SSH server key size	GC
<code>ip ssh timeout</code>	Specifies the authentication timeout for the SSH server	GC
<code>copy tftp public-key</code>	Copies the user's public key from a TFTP server to the switch	PE
<code>delete public-key</code>	Deletes the public key for the specified user	PE
<code>disconnect</code>	Terminates a line connection	PE
<code>ip ssh crypto host-key generate</code>	Generates the host key	PE
<code>ip ssh crypto zeroize</code>	Clear the host key from RAM	PE
<code>ip ssh save host-key</code>	Saves the host key from RAM to flash memory	PE
<code>show ip ssh</code>	Displays the status of the SSH server and the configured values for authentication timeout and retries	PE
<code>show public-key</code>	Shows the public key for the specified user or for the host	PE
<code>show ssh</code>	Displays the status of current SSH sessions	PE
<code>show users</code>	Shows SSH users, including privilege level and public key type	PE

Configuration Guidelines

The SSH server on this switch supports both password and public key authentication. If password authentication is specified by the SSH client, then the password can be authenticated either locally or via a RADIUS or TACACS+ remote authentication server, as specified by the `authentication login` command. If public key authentication is specified by the client, then you must configure authentication keys on both the client and the switch as described in the following section. Note that regardless of whether you use public key or password authentication, you still have to generate authentication keys on the switch and enable the SSH server.

To use the SSH server, complete these steps:

1. Generate a Host Key Pair – Use the `ip ssh crypto host-key generate` command to create a host public/private key pair.
2. Provide Host Public Key to Clients – Many SSH client programs automatically import the host public key during the initial connection setup with the switch. Otherwise, you need to manually create a known hosts file on the management station and place the host public key in it. An entry for a public key in the known hosts file would appear similar to the following example:

```
10.1.0.54 1024 35
15684995401867669259333946775054617325313674890836547254
15020245593199868544358361651999923329781766065830956
10825913212890233765468017262725714134287629413011961955667825
95664104869574278881462065194174677298486546861571773939016477
93559423035774130980227370877945452408397175264635805817671670
9574804776117
```

3. Import Client's Public Key to the Switch – Use the `copy tftp public-key` command to copy a file containing the public key for all the SSH client's granted management access to the switch. (Note that these clients must be configured locally on the switch with the `username` command.) The clients are subsequently authenticated using these keys. The current firmware only accepts public key files based on standard UNIX format as shown in the following example for an RSA key:

```
1024 35
13410816856098939210409449201554253476316419218729589211431738
80055536161631051775940838686311092912322268285192543746031009
37187721199696317813662774141689851320491172048303392543241016
37997592371449011938006090253948408482717819437228840253311595
2134861022902978982721353267131629432532818915045306393916643
steve@192.168.1.19
```

4. Set the Optional Parameters – Set other optional parameters, including the authentication timeout, the number of retries, and the server key size.
5. Enable SSH Service – Use the `ip ssh server` command to enable the SSH server on the switch.
6. *Authentication* – One of the following authentication methods is employed:

Password Authentication (for SSH v1.5 or V2 Clients)

- a. The client sends its password to the server.
- b. The switch compares the client's password to those stored in memory.
- c. If a match is found, the connection is allowed.



NOTE: To use SSH with only password authentication, the host public key must still be given to the client, either during initial connection or manually

entered into the known host file. However, you do not need to configure the client's keys.

Public Key Authentication – When an SSH client attempts to contact the switch, the SSH server uses the host key pair to negotiate a session key and encryption method. Only clients that have a private key corresponding to the public keys stored on the switch can access it. The following exchanges take place during this process:

Authenticating SSH v1.5 Clients

- a. The client sends its RSA public key to the switch.
- b. The switch compares the client's public key to those stored in memory.
- c. If a match is found, the switch uses its secret key to generate a random 256-bit string as a challenge, encrypts this string with the user's public key, and sends it to the client.
- d. The client uses its private key to decrypt the challenge string, computes the MD5 checksum, and sends the checksum back to the switch.
- e. The switch compares the checksum sent from the client against that computed for the original string it sent. If the two check sums match, this means that the client's private key corresponds to an authorized public key, and the client is authenticated.

Authenticating SSH v2 Clients

- a. The client first queries the switch to determine if DSA public key authentication using a preferred algorithm is acceptable.
- b. If the specified algorithm is supported by the switch, it notifies the client to proceed with the authentication process. Otherwise, it rejects the request.
- c. The client sends a signature generated using the private key to the switch.
- d. When the server receives this message, it checks whether the supplied key is acceptable for authentication, and if so, it then checks whether the signature is correct. If both checks succeed, the client is authenticated.



NOTE: The SSH server supports up to eight client sessions. The maximum number of client sessions includes both current Telnet sessions and SSH sessions.

NOTE: The SSH server can be accessed using any configured IPv4 or IPv6 interface address on the switch.

ip ssh authentication-retries This command configures the number of times the SSH server attempts to reauthenticate a user. Use the **no** form to restore the default setting.

SYNTAX

ip ssh authentication-retries *count*

no ip ssh authentication-retries

count – The number of authentication attempts permitted after which the interface is reset. (Range: 1-5)

DEFAULT SETTING

3

COMMAND MODE

Global Configuration

EXAMPLE

```
Console(config)#ip ssh authentication-retries 2
Console(config)#
```

RELATED COMMANDS

[show ip ssh \(860\)](#)

ip ssh server This command enables the Secure Shell (SSH) server on this switch. Use the **no** form to disable this service.

SYNTAX

[no] ip ssh server

DEFAULT SETTING

Disabled

COMMAND MODE

Global Configuration

COMMAND USAGE

- ◆ The SSH server supports up to eight client sessions. The maximum number of client sessions includes both current Telnet sessions and SSH sessions.
- ◆ The SSH server uses DSA or RSA for key exchange when the client first establishes a connection with the switch, and then negotiates with the client to select either DES (56-bit) or 3DES (168-bit) for data encryption.
- ◆ You must generate DSA and RSA host keys before enabling the SSH server.

EXAMPLE

```
Console#ip ssh crypto host-key generate dsa
Console#configure
Console(config)#ip ssh server
Console(config)#
```

RELATED COMMANDS

[ip ssh crypto host-key generate \(858\)](#)
[show ssh \(862\)](#)

ip ssh server-key size This command sets the SSH server key size. Use the **no** form to restore the default setting.

SYNTAX

ip ssh server-key size *key-size*

no ip ssh server-key size

key-size – The size of server key. (Range: 512-896 bits)

DEFAULT SETTING

768 bits

COMMAND MODE

Global Configuration

COMMAND USAGE

The server key is a private key that is never shared outside the switch. The host key is shared with the SSH client, and is fixed at 1024 bits.

EXAMPLE

```
Console(config)#ip ssh server-key size 512
Console(config)#
```

ip ssh timeout This command configures the timeout for the SSH server. Use the **no** form to restore the default setting.

SYNTAX

ip ssh timeout *seconds*

no ip ssh timeout

seconds – The timeout for client response during SSH negotiation. (Range: 1-120)

DEFAULT SETTING

10 seconds

COMMAND MODE

Global Configuration

COMMAND USAGE

The **timeout** specifies the interval the switch will wait for a response from the client during the SSH negotiation phase. Once an SSH session has been established, the timeout for user input is controlled by the [exec-timeout](#) command for vty sessions.

EXAMPLE

```
Console(config)#ip ssh timeout 60
Console(config)#
```

RELATED COMMANDS

[exec-timeout \(750\)](#)

[show ip ssh \(860\)](#)

delete public-key This command deletes the specified user's public key.

SYNTAX

delete public-key *username* [**dsa** | **rsa**]

username – Name of an SSH user. (Range: 1-8 characters)

dsa – DSA public key type.

rsa – RSA public key type.

DEFAULT SETTING

Deletes both the DSA and RSA key.

COMMAND MODE

Privileged Exec

EXAMPLE

```
Console#delete public-key admin dsa
Console#
```

ip ssh crypto host-key generate This command generates the host key pair (i.e., public and private).

SYNTAX

ip ssh crypto host-key generate [**dsa** | **rsa**]

dsa – DSA (Version 2) key type.

rsa – RSA (Version 1) key type.

DEFAULT SETTING

Generates both the DSA and RSA key pairs.

COMMAND MODE

Privileged Exec

COMMAND USAGE

- ◆ The switch uses only RSA Version 1 for SSHv1.5 clients and DSA Version 2 for SSHv2 clients.
- ◆ This command stores the host key pair in memory (i.e., RAM). Use the [ip ssh save host-key](#) command to save the host key pair to flash memory.
- ◆ Some SSH client programs automatically add the public key to the known hosts file as part of the configuration process. Otherwise, you must manually create a known hosts file and place the host public key in it.
- ◆ The SSH server uses this host key to negotiate a session key and encryption method with the client trying to connect to it.

EXAMPLE

```
Console#ip ssh crypto host-key generate dsa
Console#
```

RELATED COMMANDS

[ip ssh crypto zeroize \(859\)](#)
[ip ssh save host-key \(860\)](#)

ip ssh crypto zeroize This command clears the host key from memory (i.e. RAM).

SYNTAX

ip ssh crypto zeroize [dsa | rsa]

dsa – DSA key type.

rsa – RSA key type.

DEFAULT SETTING

Clears both the DSA and RSA key.

COMMAND MODE

Privileged Exec

COMMAND USAGE

- ◆ This command clears the host key from volatile memory (RAM). Use the **no** [ip ssh save host-key](#) command to clear the host key from flash memory.

- ◆ The SSH server must be disabled before you can execute this command.

EXAMPLE

```
Console#ip ssh crypto zeroize dsa
Console#
```

RELATED COMMANDS

[ip ssh crypto host-key generate \(858\)](#)
[ip ssh save host-key \(860\)](#)
[no ip ssh server \(856\)](#)

ip ssh save host-key This command saves the host key from RAM to flash memory.

SYNTAX

ip ssh save host-key

DEFAULT SETTING

Saves both the DSA and RSA key.

COMMAND MODE

Privileged Exec

EXAMPLE

```
Console#ip ssh save host-key dsa
Console#
```

RELATED COMMANDS

[ip ssh crypto host-key generate \(858\)](#)

show ip ssh This command displays the connection settings used when authenticating client access to the SSH server.

COMMAND MODE

Privileged Exec

EXAMPLE

```
Console#show ip ssh
SSH Enabled - Version 2.0
Negotiation Timeout : 120 seconds; Authentication Retries : 3
Server Key Size      : 768 bits
Console#
```

show public-key This command shows the public key for the specified user or for the host.

SYNTAX

show public-key [user [username]] host]

username – Name of an SSH user. (Range: 1-8 characters)

DEFAULT SETTING

Shows all public keys.

COMMAND MODE

Privileged Exec

COMMAND USAGE

- ◆ If no parameters are entered, all keys are displayed. If the user keyword is entered, but no user name is specified, then the public keys for all users are displayed.
- ◆ When an RSA key is displayed, the first field indicates the size of the host key (e.g., 1024), the second field is the encoded public exponent (e.g., 35), and the last string is the encoded modulus. When a DSA key is displayed, the first field indicates that the encryption method used by SSH is based on the Digital Signature Standard (DSS), and the last string is the encoded modulus.

EXAMPLE

```

Console#show public-key host
Host:
RSA:
1024 65537 13236940658254764031382795526536375927835525327972629521130241
071942106165575942459093923609695405036277525755625100386613098939383452310
332802149888661921595568598879891919505883940181387440468908779160305837768
185490002831341625008348718449522087429212255691665655296328163516964040831
5547660664151657116381
DSA:
ssh-dss AAB3NzaC1kc3MAAACBAPWKZTPbsRIB8ydEXcxM3dyV/yrDbKStIlnzD/Dg0h2Hxc
YV44sXZ2JXhamLK6P8bvuiyacWbUW/a4PATp1KMSdqsKeh3hKoA3vRRSy1N2XFfAKx15fwFfv
JlPdOkFgzLGMInvSNYQwiQXbKTBH0Z4mUZpe85PwxDZMacNBpJBrRAAAAFQChb4vsdfQGNIjwbv
wrNLQ77isiwAAAIEAsy5YWDC99ebYHNRj5kh47wY4i8cZvH+/p9cnrfwFTMU01VFDly3IR
2G395NLy5Qd7ZDxfA9mCOFT/yyEfbobMJZi8oGCstSN0xrZZVnMqWrTYfdrKX7YKBw/Kjw6Bm
iFq70+jAhf1Dg45loAc27s6TLdtny1wRq/ow2eTCD5nekAAACBAJ8rMccXTxHLFAczWS7EjOy
Dbs1oBfPuSAb4oAsyjKXKVYNLQkTLZfcFRu41bS2KV5LAWecsigF/+DjKGWtPNIQqabKgYCw2
o/dVzX4Gg+yqdTlYmGA7fHGm8ARGeiG4ssFKy4Z6DmYPXFum1Yg0FhLwuHpOSKdxT3kk475S7
w0W
Console#

```

show ssh This command displays the current SSH server connections.

COMMAND MODE
Privileged Exec

EXAMPLE

```

Console#show ssh
Connection Version State Username Encryption
0 2.0 Session-Started admin ctos aes128-cbc-hmac-md5
stoc aes128-cbc-hmac-md5
Console#
    
```

Table 86: show ssh - display description

Field	Description
Connection	The session number. (Range: 0-3)
Version	The Secure Shell version number.
State	The authentication negotiation state. (Values: Negotiation-Started, Authentication-Started, Session-Started)
Username	The user name of the client.

802.1X PORT AUTHENTICATION

The switch supports IEEE 802.1X (dot1x) port-based access control that prevents unauthorized access to the network by requiring users to first submit credentials for authentication. Client authentication is controlled centrally by a RADIUS server using EAP (Extensible Authentication Protocol).

Table 87: 802.1X Port Authentication Commands

Command	Function	Mode
<i>General Commands</i>		
<code>dot1x default</code>	Resets all dot1x parameters to their default values	GC
<code>dot1x eapol-pass-through</code>	Passes EAPOL frames to all ports in STP forwarding state when dot1x is globally disabled	GC
<code>dot1x system-auth-control</code>	Enables dot1x globally on the switch.	GC
<i>Authenticator Commands</i>		
<code>dot1x intrusion-action</code>	Sets the port response to intrusion when authentication fails	IC
<code>dot1x max-reauth-req</code>	Sets the maximum number of times that the switch sends an EAP-request/identity frame to the client before restarting the authentication process	IC
<code>dot1x max-req</code>	Sets the maximum number of times that the switch retransmits an EAP request/identity packet to the client before it times out the authentication session	IC
<code>dot1x operation-mode</code>	Allows single or multiple hosts on an dot1x port	IC

Table 87: 802.1X Port Authentication Commands (Continued)

Command	Function	Mode
<code>dot1x port-control</code>	Sets dot1x mode for a port interface	IC
<code>dot1x re-authentication</code>	Enables re-authentication for all ports	IC
<code>dot1x timeout quiet-period</code>	Sets the time that a switch port waits after the Max Request Count has been exceeded before attempting to acquire a new client	IC
<code>dot1x timeout re-authperiod</code>	Sets the time period after which a connected client must be re-authenticated	IC
<code>dot1x timeout supp-timeout</code>	Sets the interval for a supplicant to respond	IC
<code>dot1x timeout tx-period</code>	Sets the time period during an authentication session that the switch waits before re-transmitting an EAP packet	IC
<code>dot1x re-authenticate</code>	Forces re-authentication on specific ports	PE
<i>Supplicant Commands</i>		
<code>dot1x identity profile</code>	Configures dot1x supplicant user name and password	GC
<code>dot1x max-start</code>	Sets the maximum number of times that a port supplicant will send an EAP start frame to the client	IC
<code>dot1x pae supplicant</code>	Enables dot1x supplicant mode on an interface	IC
<code>dot1x timeout auth-period</code>	Sets the time that a supplicant port waits for a response from the authenticator	IC
<code>dot1x timeout held-period</code>	Sets the time a port waits after the maximum start count has been exceeded before attempting to find another authenticator	IC
<code>dot1x timeout start-period</code>	Sets the time that a supplicant port waits before resending an EAPOL start frame to the authenticator	IC
<i>Display Information Commands</i>		
<code>show dot1x</code>	Shows all dot1x related information	PE

General Commands

dot1x default This command sets all configurable dot1x authenticator global and port settings to their default values.

COMMAND MODE

Global Configuration

COMMAND USAGE

This command resets the following commands to their default settings:

- ◆ `dot1x system-auth-control`
- ◆ `dot1x eapol-pass-through`
- ◆ `dot1x port-control`
- ◆ `dot1x port-control multi-host max-count`
- ◆ `dot1x operation-mode`
- ◆ `dot1x max-req`

- ◆ dot1x timeout quiet-period
- ◆ dot1x timeout tx-period
- ◆ dot1x timeout re-authperiod
- ◆ dot1x timeout sup-timeout
- ◆ dot1x re-authentication
- ◆ dot1x intrusion-action

EXAMPLE

```
Console(config)#dot1x default
Console(config)#
```

dot1x eapol-pass-through

This command passes EAPOL frames through to all ports in STP forwarding state when dot1x is globally disabled. Use the **no** form to restore the default.

SYNTAX

[no] **dot1x eapol-pass-through**

DEFAULT SETTING

Discards all EAPOL frames when dot1x is globally disabled

COMMAND MODE

Global Configuration

COMMAND USAGE

- ◆ When this device is functioning as intermediate node in the network and does not need to perform dot1x authentication, the **dot1x eapol pass-through** command can be used to forward EAPOL frames from other switches on to the authentication servers, thereby allowing the authentication process to still be carried out by switches located on the edge of the network.
- ◆ When this device is functioning as an edge switch but does not require any attached clients to be authenticated, the **no dot1x eapol-pass-through** command can be used to discard unnecessary EAPOL traffic.

EXAMPLE

This example instructs the switch to pass all EAPOL frame through to any ports in STP forwarding state.

```
Console(config)#dot1x eapol-pass-through
Console(config)#
```

dot1x system-auth-control This command enables IEEE 802.1X port authentication globally on the switch. Use the **no** form to restore the default.

SYNTAX

[no] dot1x system-auth-control

DEFAULT SETTING

Disabled

COMMAND MODE

Global Configuration

EXAMPLE

```
Console(config)#dot1x system-auth-control
Console(config)#
```

Authenticator Commands

dot1x intrusion-action This command sets the port's response to a failed authentication, either to block all traffic, or to assign all traffic for the port to a guest VLAN. Use the **no** form to reset the default.

SYNTAX

dot1x intrusion-action {block-traffic | guest-vlan}

no dot1x intrusion-action

block-traffic - Blocks traffic on this port.

guest-vlan - Assigns the user to the Guest VLAN.

DEFAULT

block-traffic

COMMAND MODE

Interface Configuration

COMMAND USAGE

For guest VLAN assignment to be successful, the VLAN must be configured and set as active (see the [vlan database](#) command) and assigned as the guest VLAN for the port (see the [network-access guest-vlan](#) command).

EXAMPLE

```
Console(config)#interface eth 1/2
Console(config-if)#dot1x intrusion-action guest-vlan
Console(config-if)#
```

dot1x max-reauth-req This command sets the maximum number of times that the switch sends an EAP-request/identity frame to the client before restarting the authentication process. Use the **no** form to restore the default.

SYNTAX

dot1x max-reauth-req *count*

no dot1x max-reauth-req

count – The maximum number of requests (Range: 1-10)

DEFAULT

2

COMMAND MODE

Interface Configuration

EXAMPLE

```
Console(config)#interface eth 1/2
Console(config-if)#dot1x max-reauth-req 2
Console(config-if)#
```

dot1x max-req This command sets the maximum number of times the switch port will retransmit an EAP request/identity packet to the client before it times out the authentication session. Use the **no** form to restore the default.

SYNTAX

dot1x max-req *count*

no dot1x max-req

count – The maximum number of requests (Range: 1-10)

DEFAULT

2

COMMAND MODE

Interface Configuration

EXAMPLE

```
Console(config)#interface eth 1/2
Console(config-if)#dot1x max-req 2
Console(config-if)#
```

dot1x operation-mode This command allows hosts (clients) to connect to an 802.1X-authorized port. Use the **no** form with no keywords to restore the default to single host. Use the **no** form with the **multi-host max-count** keywords to restore the default maximum count.

SYNTAX

```
dot1x operation-mode {single-host |  
multi-host [max-count count] | mac-based-auth}
```

```
no dot1x operation-mode [multi-host max-count]
```

single-host – Allows only a single host to connect to this port.

multi-host – Allows multiple host to connect to this port.

max-count – Keyword for the maximum number of hosts.

count – The maximum number of hosts that can connect to a port. (Range: 1-1024; Default: 5)

mac-based – Allows multiple hosts to connect to this port, with each host needing to be authenticated.

DEFAULT

Single-host

COMMAND MODE

Interface Configuration

COMMAND USAGE

- ◆ The “max-count” parameter specified by this command is only effective if the dot1x mode is set to “auto” by the [dot1x port-control](#) command.
- ◆ In “multi-host” mode, only one host connected to a port needs to pass authentication for all other hosts to be granted network access. Similarly, a port can become unauthorized for all hosts if one attached host fails re-authentication or sends an EAPOL logoff message.
- ◆ In “mac-based-auth” mode, each host connected to a port needs to pass authentication. The number of hosts allowed access to a port operating in this mode is limited only by the available space in the secure address table (i.e., up to 1024 addresses).

EXAMPLE

```
Console(config)#interface eth 1/2  
Console(config-if)#dot1x operation-mode multi-host max-count 10  
Console(config-if)#
```

dot1x port-control This command sets the dot1x mode on a port interface. Use the **no** form to restore the default.

SYNTAX

dot1x port-control {**auto** | **force-authorized** | **force-unauthorized**}

no dot1x port-control

auto – Requires a dot1x-aware connected client to be authorized by the RADIUS server. Clients that are not dot1x-aware will be denied access.

force-authorized – Configures the port to grant access to all clients, either dot1x-aware or otherwise.

force-unauthorized – Configures the port to deny access to all clients, either dot1x-aware or otherwise.

DEFAULT

force-authorized

COMMAND MODE

Interface Configuration

EXAMPLE

```
Console(config)#interface eth 1/2
Console(config-if)#dot1x port-control auto
Console(config-if)#
```

dot1x re-authentication This command enables periodic re-authentication for a specified port. Use the **no** form to disable re-authentication.

SYNTAX

[**no**] **dot1x re-authentication**

COMMAND MODE

Interface Configuration

COMMAND USAGE

- ◆ The re-authentication process verifies the connected client's user ID and password on the RADIUS server. During re-authentication, the client remains connected the network and the process is handled transparently by the dot1x client software. Only if re-authentication fails is the port blocked.
- ◆ The connected client is re-authenticated after the interval specified by the **dot1x timeout re-authperiod** command. The default is 3600 seconds.

EXAMPLE

```
Console(config)#interface eth 1/2
Console(config-if)#dot1x re-authentication
Console(config-if)#
```

RELATED COMMANDS

[dot1x timeout re-authperiod \(869\)](#)

dot1x timeout quiet-period This command sets the time that a switch port waits after the maximum request count (see [page 866](#)) has been exceeded before attempting to acquire a new client. Use the **no** form to reset the default.

SYNTAX

dot1x timeout quiet-period *seconds*

no dot1x timeout quiet-period

seconds - The number of seconds. (Range: 1-65535)

DEFAULT

60 seconds

COMMAND MODE

Interface Configuration

EXAMPLE

```
Console(config)#interface eth 1/2
Console(config-if)#dot1x timeout quiet-period 350
Console(config-if)#
```

dot1x timeout re-authperiod This command sets the time period after which a connected client must be re-authenticated. Use the **no** form of this command to reset the default.

SYNTAX

dot1x timeout re-authperiod *seconds*

no dot1x timeout re-authperiod

seconds - The number of seconds. (Range: 1-65535)

DEFAULT

3600 seconds

COMMAND MODE

Interface Configuration

EXAMPLE

```
Console(config)#interface eth 1/2
Console(config-if)#dot1x timeout re-authperiod 300
Console(config-if)#
```

dot1x timeout supp-timeout This command sets the time that an interface on the switch waits for a response to an EAP request from a client before re-transmitting an EAP packet. Use the **no** form to reset to the default value.

SYNTAX

dot1x timeout supp-timeout *seconds*

no dot1x timeout supp-timeout

seconds - The number of seconds. (Range: 1-65535)

DEFAULT

30 seconds

COMMAND MODE

Interface Configuration

COMMAND USAGE

This command sets the timeout for EAP-request frames other than EAP-request/identity frames. If dot1x authentication is enabled on a port, the switch will initiate authentication when the port link state comes up. It will send an EAP-request/identity frame to the client to request its identity, followed by one or more requests for authentication information. It may also send other EAP-request frames to the client during an active connection as required for reauthentication.

EXAMPLE

```
Console(config)#interface eth 1/2
Console(config-if)#dot1x timeout supp-timeout 300
Console(config-if)#
```

dot1x timeout tx-period This command sets the time that an interface on the switch waits during an authentication session before re-transmitting an EAP packet. Use the **no** form to reset to the default value.

SYNTAX

dot1x timeout tx-period *seconds*

no dot1x timeout tx-period

seconds - The number of seconds. (Range: 1-65535)

DEFAULT
30 seconds

COMMAND MODE
Interface Configuration

EXAMPLE

```
Console(config)#interface eth 1/2
Console(config-if)#dot1x timeout tx-period 300
Console(config-if)#
```

dot1x re-authenticate This command forces re-authentication on all ports or a specific interface.

SYNTAX

dot1x re-authenticate [*interface*]

interface

ethernet *unit/port*

unit - Unit identifier. (Range: 1)

port - Port number. (Range: 1-28/52)

COMMAND MODE
Privileged Exec

COMMAND USAGE

The re-authentication process verifies the connected client's user ID and password on the RADIUS server. During re-authentication, the client remains connected the network and the process is handled transparently by the dot1x client software. Only if re-authentication fails is the port blocked.

EXAMPLE

```
Console#dot1x re-authenticate
Console#
```

Supplicant Commands

dot1x identity profile This command sets the dot1x supplicant user name and password. Use the **no** form to delete the identity settings.

SYNTAX

dot1x identity profile {**username** *username* | **password** *password*}

no dot1x identity profile {**username** | **password**}

username - Specifies the supplicant user name.
(Range: 1-11 characters)

password - Specifies the supplicant password.
(Range: 1-8 characters)

DEFAULT

No user name or password

COMMAND MODE

Global Configuration

COMMAND USAGE

The global supplicant user name and password are used to identify this switch as a supplicant when responding to an MD5 challenge from the authenticator. These parameters must be set when this switch passes client authentication requests to another authenticator on the network (see the [dot1x pae supplicant](#) command).

EXAMPLE

```
Console(config)#dot1x identity profile username steve
Console(config)#dot1x identity profile password excess
Console(config)#
```

dot1x max-start This command sets the maximum number of times that a port supplicant will send an EAP start frame to the client before assuming that the client is 802.1X unaware. Use the **no** form to restore the default value.

SYNTAX

dot1x max-start *count*

no dot1x max-start

count - Specifies the maximum number of EAP start frames.
(Range: 1-65535)

DEFAULT

3

COMMAND MODE
Interface Configuration**EXAMPLE**

```
Console(config)#interface eth 1/2
Console(config-if)#dot1x max-start 10
Console(config-if)#
```

dot1x pae supplicant This command enables dot1x supplicant mode on a port. Use the **no** form to disable dot1x supplicant mode on a port.

SYNTAX

[no] dot1x pae supplicant

DEFAULT

Disabled

COMMAND MODE
Interface Configuration**COMMAND USAGE**

- ◆ When devices attached to a port must submit requests to another authenticator on the network, configure the identity profile parameters (see [dot1x identity profile](#) command) which identify this switch as a supplicant, and enable dot1x supplicant mode for those ports which must authenticate clients through a remote authenticator using this command. In this mode the port will not respond to dot1x messages meant for an authenticator.
- ◆ This switch can be configured to serve as the authenticator on selected ports by setting the control mode to "auto" (see the [dot1x port-control](#) command), and as a supplicant on other ports by the setting the control mode to "force-authorized" and enabling dot1x supplicant mode with this command.
- ◆ A port cannot be configured as a dot1x supplicant if it is a member of a trunk or LACP is enabled on the port.

EXAMPLE

```
Console(config)#interface ethernet 1/2
Console(config-if)#dot1x pae supplicant
Console(config-if)#
```

dot1x timeout auth-period This command sets the time that a supplicant port waits for a response from the authenticator. Use the **no** form to restore the default setting.

SYNTAX

dot1x timeout auth-period *seconds*

no dot1x timeout auth-period

seconds - The number of seconds. (Range: 1-65535)

DEFAULT

30 seconds

COMMAND MODE

Interface Configuration

COMMAND USAGE

This command sets the time that the supplicant waits for a response from the authenticator for packets other than EAPOL-Start.

EXAMPLE

```
Console(config)#interface eth 1/2
Console(config-if)#dot1x timeout auth-period 60
Console(config-if)#
```

dot1x timeout held-period This command sets the time that a supplicant port waits before resending its credentials to find a new an authenticator. Use the **no** form to reset the default.

SYNTAX

dot1x timeout held-period *seconds*

no dot1x timeout held-period

seconds - The number of seconds. (Range: 1-65535)

DEFAULT

60 seconds

COMMAND MODE

Interface Configuration

EXAMPLE

```
Console(config)#interface eth 1/2
Console(config-if)#dot1x timeout held-period 120
Console(config-if)#
```

dot1x timeout start-period This command sets the time that a supplicant port waits before resending an EAPOL start frame to the authenticator. Use the **no** form to restore the default setting.

SYNTAX

dot1x timeout start-period *seconds*

no dot1x timeout start-period

seconds - The number of seconds. (Range: 1-65535)

DEFAULT

30 seconds

COMMAND MODE

Interface Configuration

EXAMPLE

```
Console(config)#interface eth 1/2
Console(config-if)#dot1x timeout start-period 60
Console(config-if)#
```

Information Display Commands

show dot1x This command shows general port authentication related settings on the switch or a specific interface.

SYNTAX

show dot1x [**statistics**] [**interface** *interface*]

statistics - Displays dot1x status for each port.

interface

ethernet *unit/port*

unit - Unit identifier. (Range: 1)

port - Port number. (Range: 1-28/52)

COMMAND MODE

Privileged Exec

COMMAND USAGE

This command displays the following information:

- ◆ *Global 802.1X Parameters* – Shows whether or not 802.1X port authentication is globally enabled on the switch ([page 865](#)).
- ◆ *Authenticator Parameters* – Shows whether or not EAPOL pass-through is enabled ([page 864](#)).

- ◆ *Supplicant Parameters* – Shows the supplicant user name used when the switch responds to an MD5 challenge from an authenticator ([page 872](#)).
- ◆ *802.1X Port Summary* – Displays the port access control parameters for each interface that has enabled 802.1X, including the following items:
 - Type – Administrative state for port access control (Enabled, Authenticator, or Supplicant).
 - Operation Mode–Allows single or multiple hosts ([page 867](#)).
 - Control Mode – Dot1x port control mode ([page 868](#)).
 - Authorized– Authorization status (yes or n/a - not authorized).
- ◆ *802.1X Port Details* – Displays the port access control parameters for each interface, including the following items:
 - Reauthentication – Periodic re-authentication ([page 868](#)).
 - Reauth Period – Time after which a connected client must be re-authenticated ([page 869](#)).
 - Quiet Period – Time a port waits after Max Request Count is exceeded before attempting to acquire a new client ([page 869](#)).
 - TX Period – Time a port waits during authentication session before re-transmitting EAP packet ([page 870](#)).
 - Supplicant Timeout – Supplicant timeout.
 - Server Timeout – Server timeout. A RADIUS server must be set before the correct operational value of 10 seconds will be displayed in this field.
 - Reauth Max Retries – Maximum number of reauthentication attempts.
 - Max Request – Maximum number of times a port will retransmit an EAP request/identity packet to the client before it times out the authentication session ([page 866](#)).
 - Operation Mode– Shows if single or multiple hosts (clients) can connect to an 802.1X-authorized port.
 - Port Control–Shows the dot1x mode on a port as auto, force-authorized, or force-unauthorized ([page 868](#)).
 - Intrusion Action– Shows the port response to intrusion when authentication fails ([page 865](#)).
 - Supplicant– MAC address of authorized client.
- ◆ *Authenticator PAE State Machine*
 - State – Current state (including initialize, disconnected, connecting, authenticating, authenticated, aborting, held, force_authorized, force_unauthorized).
 - Reauth Count– Number of times connecting state is re-entered.
 - Current Identifier– The integer (0-255) used by the Authenticator to identify the current authentication session.
- ◆ *Backend State Machine*
 - State – Current state (including request, response, success, fail, timeout, idle, initialize).

- Request Count- Number of EAP Request packets sent to the Supplicant without receiving a response.
- Identifier (Server)- Identifier carried in the most recent EAP Success, Failure or Request packet received from the Authentication Server.

◆ *Reauthentication State Machine*

State - Current state (including initialize, reauthenticate).

EXAMPLE

```

Console#show dot1x
Global 802.1X Parameters
  System Auth Control      : Enabled

Authenticator Parameters:
  EAPOL Pass Through      : Disabled

Supplicant Parameters:
  Identity Profile Username : steve

802.1X Port Summary

Port      Type      Operation Mode Control Mode    Authorized
-----
Eth 1/ 1 Disabled  Single-Host   Force-Authorized Yes
Eth 1/ 2 Disabled  Single-Host   Force-Authorized Yes
.
.
Eth 1/49 Disabled  Single-Host   Force-Authorized Yes
Eth 1/50 Enabled   Single-Host   Auto          Yes

802.1X Port Details

802.1X Authenticator is enabled on port 1/1
802.1X Supplicant is disabled on port 1/1
.
.
802.1X Authenticator is enabled on port 50
Reauthentication      : Enabled
Reauth Period         : 3600
Quiet Period          : 60
TX Period              : 30
Supplicant Timeout    : 30
Server Timeout        : 10
Reauth Max Retries    : 2
Max Request           : 2
Operation Mode        : Multi-host
Port Control          : Auto
Intrusion Action      : Block traffic

Supplicant             : 00-e0-29-94-34-65

Authenticator PAE State Machine
  State                : Authenticated
  Reauth Count         : 0
  Current Identifier   : 3

Backend State Machine
  State                : Idle
  Request Count        : 0
  
```

```
Identifier (Server) : 2  
  
Reauthentication State Machine  
State : Initialize  
  
Console#
```

MANAGEMENT IP FILTER

This section describes commands used to configure IP management access to the switch.

Table 88: Management IP Filter Commands

Command	Function	Mode
<code>management</code>	Configures IP addresses that are allowed management access	GC
<code>show management</code>	Displays the switch to be monitored or configured from a browser	PE

management This command specifies the client IP addresses that are allowed management access to the switch through various protocols. A list of up to 15 IP addresses or IP address groups can be specified. Use the **no** form to restore the default setting.

SYNTAX

```
[no] management {all-client | http-client | snmp-client |  
telnet-client} start-address [end-address]
```

all-client - Adds IP address(es) to all groups.

http-client - Adds IP address(es) to the web group.

snmp-client - Adds IP address(es) to the SNMP group.

telnet-client - Adds IP address(es) to the Telnet group.

start-address - A single IP address, or the starting address of a range.

end-address - The end address of a range.

DEFAULT SETTING

All addresses

COMMAND MODE

Global Configuration

COMMAND USAGE

- ◆ The management interfaces are open to all IP addresses by default. Once you add an entry to a filter list, access to that interface is restricted to the specified addresses.

- ◆ If anyone tries to access a management interface on the switch from an invalid address, the switch will reject the connection, enter an event message in the system log, and send a trap message to the trap manager.
- ◆ IP address can be configured for SNMP, web, and Telnet access respectively. Each of these groups can include up to five different sets of addresses, either individual addresses or address ranges.
- ◆ When entering addresses for the same group (i.e., SNMP, web, or Telnet), the switch will not accept overlapping address ranges. When entering addresses for different groups, the switch will accept overlapping address ranges.
- ◆ You cannot delete an individual address from a specified range. You must delete the entire range, and re-enter the addresses.
- ◆ You can delete an address range just by specifying the start address, or by specifying both the start address and end address.

EXAMPLE

This example restricts management access to the indicated addresses.

```
Console(config)#management all-client 192.168.1.19
Console(config)#management all-client 192.168.1.25 192.168.1.30
Console#
```

show management This command displays the client IP addresses that are allowed management access to the switch through various protocols.

SYNTAX

show management {all-client | http-client | snmp-client | telnet-client}

all-client - Displays IP addresses for all groups.

http-client - Displays IP addresses for the web group.

snmp-client - Displays IP addresses for the SNMP group.

telnet-client - Displays IP addresses for the Telnet group.

COMMAND MODE

Privileged Exec

EXAMPLE

```
Console#show management all-client
Management Ip Filter
HTTP-Client:
  Start IP address      End IP address
-----
1. 192.168.1.19        192.168.1.19
2. 192.168.1.25        192.168.1.30
```

```

SNMP-Client:
  Start IP address      End IP address
-----
1. 192.168.1.19        192.168.1.19
2. 192.168.1.25        192.168.1.30

TELNET-Client:
  Start IP address      End IP address
-----
1. 192.168.1.19        192.168.1.19
2. 192.168.1.25        192.168.1.30

Console#

```

PPPoE INTERMEDIATE AGENT

This section describes commands used to configure the PPPoE Intermediate Agent (PPPoE IA) relay parameters required for passing authentication messages between a client and broadband remote access servers.

Table 89: PPPoE Intermediate Agent Commands

Command	Function	Mode
<code>pppoe intermediate-agent</code>	Enables the PPPoE IA globally on the switch	GC
<code>pppoe intermediate-agent format-type</code>	Sets the access node identifier and generic error message for the switch	GC
<code>pppoe intermediate-agent port-enable</code>	Enables the PPPoE IA on an interface	IC
<code>pppoe intermediate-agent port-format-type</code>	Sets the circuit-id or remote-id for an interface	IC
<code>pppoe intermediate-agent trust</code>	Sets the trust mode for an interface	IC
<code>pppoe intermediate-agent vendor-tag strip</code>	Enables the stripping of vendor tags from PPPoE Discovery packets sent from a PPPoE server	IC
<code>clear pppoe intermediate-agent statistics</code>	Clears PPPoE IA statistics	PE
<code>show pppoe intermediate-agent info</code>	Displays PPPoE IA configuration settings	PE
<code>show pppoe intermediate-agent statistics</code>	Displays PPPoE IA statistics	PE

pppoe intermediate-agent This command enables the PPPoE Intermediate Agent globally on the switch. Use the **no** form to disable this feature.

SYNTAX

[no] pppoe intermediate-agent

DEFAULT SETTING

Disabled

COMMAND MODE

Global Configuration

COMMAND USAGE

- ◆ The switch inserts a tag identifying itself as a PPPoE Intermediate Agent residing between the attached client requesting network access and the ports connected to broadband remote access servers (BRAS). The switch extracts access-loop information from the client's PPPoE Active Discovery Request, and forwards this information to all trusted ports designated by the **pppoe intermediate-agent trust** command. The BRAS detects the presence of the subscriber's circuit-ID tag inserted by the switch during the PPPoE discovery phase, and sends this tag as a NAS-port-ID attribute in PPP authentication and AAA accounting requests to a RADIUS server.
- ◆ PPPoE IA must be enabled globally by this command before this feature can be enabled on an interface using the **pppoe intermediate-agent port-enable** command.

EXAMPLE

```
Console(config)#pppoe intermediate-agent
Console(config)#
```

pppoe intermediate-agent format-type This command sets the access node identifier and generic error message for the switch. Use the **no** form to restore the default settings.

SYNTAX

pppoe intermediate-agent format-type {access-node-identifier *id-string* | generic-error-message *error-message*}

no pppoe intermediate-agent format-type {access-node-identifier | generic-error-message}

id-string - String identifying this switch as an PPPoE IA to the PPPoE server. (Range: 1-48 ASCII characters)

error-message - An error message notifying the sender that the PPPoE Discovery packet was too large.

DEFAULT SETTING

- ◆ Access Node Identifier: IP address of the management interface.
- ◆ Generic Error Message: PPPoE Discover packet too large to process. Try reducing the number of tags added.

COMMAND MODE

Global Configuration

COMMAND USAGE

- ◆ The switch uses the access-node-identifier to generate the circuit-id for PPPoE discovery stage packets sent to the BRAS, but does not modify the source or destination MAC address of these PPPoE discovery packets.
- ◆ These messages are forwarded to all trusted ports designated by the `pppoe intermediate-agent trust` command.

EXAMPLE

```
Console(config)#pppoe intermediate-agent format-type access-node-identifier  
billibong  
Console(config)#
```

pppoe intermediate-agent port-enable

This command enables the PPPoE IA on an interface. Use the **no** form to disable this feature.

SYNTAX

[no] pppoe intermediate-agent port-enable

DEFAULT SETTING

Disabled

COMMAND MODE

Interface Configuration (Ethernet, Port Channel)

COMMAND USAGE

PPPoE IA must also be enabled globally on the switch for this command to take effect.

EXAMPLE

```
Console(config)#interface ethernet 1/5  
Console(config-if)#pppoe intermediate-agent port-enable  
Console(config-if)#
```

**pppoe
intermediate-agent
port-format-type**

This command sets the circuit-id or remote-id for an interface. Use the **no** form to restore the default settings.

SYNTAX

pppoe intermediate-agent port-format-type {**circuit-id** | **remote-id**} *id-string*

circuit-id - String identifying the circuit identifier (or interface) on this switch to which the user is connected. (Range: 1-10 ASCII characters)

remote-id - String identifying the remote identifier (or interface) on this switch to which the user is connected. (Range: 1-63 ASCII characters)

DEFAULT SETTING

circuit-id: unit/port:vlan-id or 0/trunk-id:vlan-id
remote-id: port MAC address

COMMAND MODE

Interface Configuration (Ethernet, Port Channel)

COMMAND USAGE

- ◆ The PPPoE server extracts the Line-ID tag from PPPoE discovery stage messages, and uses the Circuit-ID field of that tag as a NAS-Port-ID attribute in AAA access and accounting requests.
- ◆ The switch intercepts PPPoE discovery frames from the client and inserts a unique line identifier using the PPPoE Vendor-Specific tag (0x0105) to PPPoE Active Discovery Initiation (PADI) and Request (PADR) packets. The switch then forwards these packets to the PPPoE server. The tag contains the Line-ID of the customer line over which the discovery packet was received, entering the switch (or access node) where the intermediate agent resides.
- ◆ Outgoing PAD Offer (PADO) and Session-confirmation (PADS) packets sent from the PPPoE Server include the Circuit-ID tag inserted by the switch, and should be stripped out of PADO and PADS packets which are to be passed directly to end-node clients using the [pppoe intermediate-agent vendor-tag strip](#) command.

EXAMPLE

```
Console(config)#interface ethernet 1/5
Console(config-if)#pppoe intermediate-agent port-format-type circuit-id
ECS4500-28
Console(config-if)#
```

pppoe intermediate-agent trust

This command sets an interface to trusted mode to indicate that it is connected to a PPPoE server. Use the **no** form to set an interface to untrusted mode.

SYNTAX

[no] pppoe intermediate-agent trust

DEFAULT SETTING

Untrusted

COMMAND MODE

Interface Configuration (Ethernet, Port Channel)

COMMAND USAGE

- ◆ Set any interfaces connecting the switch to a PPPoE Server as trusted. Interfaces that connect the switch to users (PPPoE clients) should be set as untrusted.
- ◆ At least one trusted interface must be configured on the switch for the PPPoE IA to function.

EXAMPLE

```
Console(config)#interface ethernet 1/5
Console(config-if)#pppoe intermediate-agent trust
Console(config-if)#
```

pppoe intermediate-agent vendor-tag strip

This command enables the stripping of vendor tags from PPPoE Discovery packets sent from a PPPoE server. Use the **no** form to disable this feature.

SYNTAX

[no] pppoe intermediate-agent vendor-tag strip

DEFAULT SETTING

Disabled

COMMAND MODE

Interface Configuration (Ethernet, Port Channel)

COMMAND USAGE

This command only applies to trusted interfaces. It is used to strip off vendor-specific tags (which carry subscriber and line identification information) in PPPoE Discovery packets received from an upstream PPPoE server before forwarding them to a user.

EXAMPLE

```

Console(config)#interface ethernet 1/5
Console(config-if)#pppoe intermediate-agent vendor-tag strip
Console(config-if)#

```

**clear pppoe
intermediate-agent
statistics**

This command clears statistical counters for the PPPoE Intermediate Agent.

SYNTAX

clear pppoe intermediate-agent statistics interface [*interface*]

interface

ethernet *unit/port*

unit - Stack unit. (Range: 1)

port - Port number. (Range: 1-28/52)

port-channel *channel-id* (Range: 1-16)

COMMAND MODE

Privileged Exec

EXAMPLE

```

Console#clear pppoe intermediate-agent statistics
Console#

```

**show pppoe
intermediate-agent
info**

This command displays configuration settings for the PPPoE Intermediate Agent.

SYNTAX

show pppoe intermediate-agent info [**interface** [*interface*]]

interface

ethernet *unit/port*

unit - Stack unit. (Range: 1)

port - Port number. (Range: 1-28/52)

port-channel *channel-id* (Range: 1-16)

COMMAND MODE

Privileged Exec

EXAMPLE

```

Console#show pppoe intermediate-agent info
PPPoE Intermediate Agent Global Status      : Enabled
PPPoE Intermediate Agent Admin Access Node Identifier : 192.168.0.2
PPPoE Intermediate Agent Oper Access Node Identifier : 192.168.0.2
PPPoE Intermediate Agent Admin Generic Error Message :

```

```

PPPoE Discover packet too large to process. Try reducing the number of tags
added.
PPPoE Intermediate Agent Oper Generic Error Message :
PPPoE Discover packet too large to process. Try reducing the number of tags
added.
Consoleshow pppoe intermediate-agent info interface ethernet 1/1
Interface PPPoE IA Trusted Vendor-Tag Strip Admin Circuit-ID Admin Remote-ID
Oper Circuit-ID Oper Remote-ID
-----
Eth 1/2 Yes No Yes ECS4110-52T ECS4110-52T
ECS4110-52T ECS4110-52T
Console#

```

show pppoe intermediate-agent statistics

This command displays statistics for the PPPoE Intermediate Agent.

SYNTAX

show pppoe intermediate-agent statistics interface [*interface*]
interface
ethernet *unit/port*
unit - Unit identifier. (Range: 1)
port - Port number. (Range: 1-28/52)
port-channel *channel-id* (Range: 1-16)

COMMAND MODE
Privileged Exec

EXAMPLE

```

Console#show pppoe intermediate-agent statistics interface ethernet 1/1
Eth 1/1 statistics
-----
Received : All PADI PADO PADR PADS PADT
          3 0 0 0 0 3
Dropped : Response from untrusted Request towards untrusted Malformed
          0 0 0
Console#

```

Table 90: show pppoe intermediate-agent statistics - display description

Field	Description
<i>Received</i>	
PADI	PPPoE Active Discovery Initiation
PADO	PPPoE Active Discovery Offer
PADR	PPPoE Active Discovery Request
PADS	PPPoE Active Discovery Session-Confirmation

Table 90: show pppoe intermediate-agent statistics - display description

Field	Description
PADT	PPPoE Active Discovery Terminate
<i>Dropped</i>	
Response from untrusted	Response from an interface which not been configured as trusted.
Request towards untrusted	Request sent to an interface which not been configured as trusted.
Malformed	Corrupted PPPoE message.

This switch supports many methods of segregating traffic for clients attached to each of the data ports, and for ensuring that only authorized clients gain access to the network. Port-based authentication using IEEE 802.1X is commonly used for these purposes. In addition to these method, several other options of providing client security are described in this chapter. These include port-based authentication, which can be configured to allow network client access by specifying a fixed set of MAC addresses. The addresses assigned to DHCP clients can also be carefully controlled with IP Source Guard and DHCP Snooping commands.

Table 91: General Security Commands

Command Group	Function
Port Security*	Configures secure addresses for a port
802.1X Port Authentication*	Configures host authentication on specific ports using 802.1X
Network Access*	Configures MAC authentication and dynamic VLAN assignment
Web Authentication*	Configures Web authentication
Access Control Lists*	Provides filtering for IP frames (based on address, protocol, TCP/UDP port number or TCP control code) or non-IP frames (based on MAC address or Ethernet type)
DHCPv4 Snooping*	Filters untrusted DHCPv4 messages on unsecure ports by building and maintaining a DHCPv4 snooping binding table
DHCPv6 Snooping*	Filters untrusted DHCPv6 messages on unsecure ports by building and maintaining a DHCPv6 snooping binding table
IPv4 Source Guard*	Filters IP traffic on insecure ports for which the source address cannot be identified via DHCPv4 snooping nor static source bindings
IPv6 Source Guard*	Filters IPv6 traffic on insecure ports for which the source address cannot be identified via DHCPv6 snooping nor static source bindings
ARP Inspection	Validates the MAC-to-IP address bindings in ARP packets
DoS Protection	Protects against Denial-of-Service attacks
Port-based Traffic Segmentation	Configures traffic segmentation for different client sessions based on specified downlink and uplink ports

* The priority of execution for these filtering commands is Port Security, Port Authentication, Network Access, Web Authentication, Access Control Lists, DHCP Snooping, and then IP Source Guard.

PORT SECURITY

These commands can be used to enable port security on a port.

When MAC address learning is disabled on an interface, only incoming traffic with source addresses already stored in the dynamic or static address table for this port will be authorized to access the network.

When using port security, the switch stops learning new MAC addresses on the specified port when it has reached a configured maximum number. Only incoming traffic with source addresses already stored in the dynamic or static address table for this port will be authorized to access the network. The port will drop any incoming frames with a source MAC address that is unknown or has been previously learned from another port. If a device with an unauthorized MAC address attempts to use the switch port, the intrusion will be detected and the switch can automatically take action by disabling the port and sending a trap message.

Table 92: Management IP Filter Commands

Command	Function	Mode
<code>mac-address-table static</code>	Maps a static address to a port in a VLAN	GC
<code>mac-learning</code>	Enables MAC address learning on the selected physical interface or VLAN	IC
<code>port security</code>	Configures a secure port	IC
<code>port security mac-address-as-permanent</code>	Saves the MAC addresses learned by port security as static entries.	PE
<code>show mac-address-table</code>	Displays entries in the bridge-forwarding database	PE
<code>show port security</code>	Displays port security status and secure address count	PE

mac-learning This command enables MAC address learning on the selected interface. Use the **no** form to disable MAC address learning.

SYNTAX

[no] mac-learning

DEFAULT SETTING

Enabled

COMMAND MODE

Interface Configuration (Ethernet or Port Channel)

COMMAND USAGE

- ◆ The **no mac-learning** command immediately stops the switch from learning new MAC addresses on the specified port or trunk. Incoming traffic with source addresses not stored in the static address table, will be flooded. However, if a security function such as 802.1X or DHCP snooping is enabled and mac-learning is disabled, then only incoming

traffic with source addresses stored in the static address table will be accepted, all other packets are dropped. Note that the dynamic addresses stored in the address table when MAC address learning is disabled are flushed from the system, and no dynamic addresses are subsequently learned until MAC address learning has been re-enabled.

- ◆ The `mac-learning` commands cannot be used if 802.1X Port Authentication has been globally enabled on the switch with the `dot1x system-auth-control` command, or if MAC Address Security has been enabled by the `port security` command on the same interface.

EXAMPLE

The following example disables MAC address learning for port 2.

```
Console(config)#interface ethernet 1/2
Console(config-if)#no mac-learning
Console(config-if)#
```

RELATED COMMANDS

[show interfaces status \(1007\)](#)

port security This command enables or configures port security. Use the **no** form without any keywords to disable port security. Use the **no** form with the appropriate keyword to restore the default settings for a response to a security violation or for the maximum number of allowed addresses.

SYNTAX

port security

```
[[action {shutdown | trap | trap-and-shutdown}] |
[max-mac-count address-count]]
```

no port security [**action** | **max-mac-count**]

action - Response to take when port security is violated.

shutdown - Disable port only.

trap - Issue SNMP trap message only.

trap-and-shutdown - Issue SNMP trap message and disable port.

max-mac-count

address-count - The maximum number of MAC addresses that can be learned on a port. (Range: 0 - 1024, where 0 means disabled)

DEFAULT SETTING

Status: Disabled

Action: None

Maximum Addresses: 0

COMMAND MODE

Interface Configuration (Ethernet)

COMMAND USAGE

- ◆ The default maximum number of MAC addresses allowed on a secure port is zero (that is, port security is disabled). To use port security, you must configure the maximum number of addresses allowed on a port using the **port security max-mac-count** command.
- ◆ When port security is enabled using the **port security** command, or the maximum number of allowed addresses is set to a value lower than the current limit after port security has been enabled, the switch first clears all dynamically learned entries from the address table. It then starts learning new MAC addresses on the specified port, and stops learning addresses when it reaches a configured maximum number. Only incoming traffic with source addresses already stored in the dynamic or static address table will be accepted.
- ◆ To configure the maximum number of address entries which can be learned on a port, and then specify the maximum number of dynamic addresses allowed. The switch will learn up to the maximum number of allowed address pairs <source MAC address, VLAN> for frames received on the port. (The specified maximum address count is effective when port security is enabled or disabled.) Note that you can manually add additional secure addresses to a port using the [mac-address-table static](#) command. When the port has reached the maximum number of MAC addresses, the port will stop learning new addresses. The MAC addresses already in the address table will be retained and will not be aged out.
- ◆ MAC addresses that port security has learned, can be saved in the configuration file as static entries. See command [port security mac-address-as-permanent](#).
- ◆ If port security is enabled, and the maximum number of allowed addresses are set to a non-zero value, any device not in the address table that attempts to use the port will be prevented from accessing the switch.
- ◆ If a port is disabled due to a security violation, it must be manually re-enabled using the [no shutdown](#) command.
- ◆ A secure port has the following restrictions:
 - Cannot be connected to a network interconnection device.
 - Cannot be a trunk port.
 - RSPAN and port security are mutually exclusive functions. If port security is enabled on a port, that port cannot be set as an RSPAN uplink port, source port, or destination port. Also, when a port is configured as an RSPAN uplink port, source port, or destination port, port security cannot be enabled on that port.

EXAMPLE

The following example enables port security for port 5, and sets the response to a security violation to issue a trap message:

```
Console(config)#interface ethernet 1/5
Console(config-if)#port security action trap
```

RELATED COMMANDS

[show interfaces status \(1007\)](#)

[shutdown \(1002\)](#)

[mac-address-table static \(1086\)](#)

port security
mac-address-as-
permanent

Use this command to save the MAC addresses that port security has learned as static entries.

SYNTAX

port security mac-address-as-permanent [**interface** *interface*]

interface - Specifies a port interface.

ethernet *unit/port*

unit - This is unit 1.

port - Port number. (Range: 1-28/52)

COMMAND MODE

Privileged Exec

EXAMPLE

This example shows the switch saving the MAC addresses learned by port security on ethernet port 1/3.

```
Console#port security mac-address-as-permanent interface ethernet 1/3
Console#
```

show port security

This command displays port security status and the secure address count.

SYNTAX

show port security [**interface** *interface*]

interface - Specifies a port interface.

ethernet *unit/port*

unit - This is unit 1.

port - Port number. (Range: 1-28/52)

COMMAND MODE
Privileged Exec

EXAMPLE

This example shows the port security settings and number of secure addresses for all ports.

```

Console#show port security
Global Port Security Parameters
  Secure MAC Aging Mode : Disabled

Port Security Port Summary
Port      Port Security Port Status  Intrusion Action  MaxMacCnt  CurrMacCnt
-----
Eth 1/ 1  Disabled          Secure/Down      None         0           2
Eth 1/ 2  Enabled            Secure/Up        None         10          0
Eth 1/ 3  Disabled          Secure/Down      None         0           0
Eth 1/ 4  Disabled          Secure/Down      None         0           0
Eth 1/ 5  Disabled          Secure/Down      None         0           0
:
:
:
    
```

Table 93: show port security - display description

Field	Description
Port Security	The configured status (enabled or disabled).
Port Status	The operational status: <ul style="list-style-type: none"> ◆ Secure/Down – Port security is disabled. ◆ Secure/Up – Port security is enabled. ◆ Shutdown – Port is shut down due to a response to a port security violation.
Intrusion Action	The configured intrusion response.
MaxMacCnt	The maximum number of addresses which can be stored in the address table for this interface (either dynamic or static).
CurrMacCnt	The current number of secure entries in the address table.

The following example shows the port security settings and number of secure addresses for a specific port. The Last Intrusion MAC and Last Time Detected Intrusion MAC fields show information about the last detected intrusion MAC address. These fields are not applicable if no intrusion has been detected or port security is disabled. The MAC Filter ID field is configured by the [network-access port-mac-filter](#) command. If this field displays Disabled, then any unknown source MAC address can be learned as a secure MAC address. If it displays a filter identifier, then only source MAC address entries in MAC Filter table can be learned as secure MAC addresses.

```

Console#show port security interface ethernet 1/2
  Secure MAC Aging Mode : Disabled

Port Security Details
Port                  : 1/2
Port Security        : Disabled
    
```

```

Port Status                : Secure/Up
Intrusion Action          : None
Max MAC Count             : 0
Current MAC Count         : 0
MAC Filter                : Disabled
Last Intrusion MAC        : NA
Last Time Detected Intrusion MAC : NA
Console#

```

This example shows information about a detected intrusion.

```

Console#show port security interface ethernet 1/2
Global Port Security Parameters
Secure MAC Aging Mode : Disabled

Port Security Details
Port                : 1/2
Port Security       : Enabled
Port Status        : Secure/Up
Intrusion Action    : None
Max MAC Count      : 0
Current MAC Count   : 0
MAC Filter ID      : 2
Last Intrusion MAC  : 00-10-22-00-00-01
Last Time Detected Intrusion MAC : 2010/7/29 15:13:03
Console#

```

NETWORK ACCESS (MAC ADDRESS AUTHENTICATION)

Network Access authentication controls access to the network by authenticating the MAC address of each host that attempts to connect to a switch port. Traffic received from a specific MAC address is forwarded by the switch only if the source MAC address is successfully authenticated by a central RADIUS server. While authentication for a MAC address is in progress, all traffic is blocked until authentication is completed. Once successfully authenticated, the RADIUS server may optionally assign VLAN and QoS settings for the switch port.

Table 94: Network Access Commands

Command	Function	Mode
<code>network-access aging</code>	Enables MAC address aging	GC
<code>network-access mac-filter</code>	Adds a MAC address to a filter table	GC
<code>mac-authentication reauth-time</code>	Sets the time period after which a connected MAC address must be re-authenticated	GC
<code>network-access dynamic-qos</code>	Enables the dynamic quality of service feature	IC
<code>network-access dynamic-vlan</code>	Enables dynamic VLAN assignment from a RADIUS server	IC
<code>network-access guest-vlan</code>	Specifies the guest VLAN	IC
<code>network-access link-detection</code>	Enables the link detection feature	IC

Table 94: Network Access Commands (Continued)

Command	Function	Mode
<code>network-access link-detection link-down</code>	Configures the link detection feature to detect and act upon link-down events	IC
<code>network-access link-detection link-up</code>	Configures the link detection feature to detect and act upon link-up events	IC
<code>network-access link-detection link-up-down</code>	Configures the link detection feature to detect and act upon both link-up and link-down events	IC
<code>network-access max-mac-count</code>	Sets the maximum number of MAC addresses that can be authenticated on a port via all forms of authentication	IC
<code>network-access mode mac-authentication</code>	Enables MAC authentication on an interface	IC
<code>network-access port-mac-filter</code>	Enables the specified MAC address filter	IC
<code>mac-authentication intrusion-action</code>	Determines the port response when a connected host fails MAC authentication.	IC
<code>mac-authentication max-mac-count</code>	Sets the maximum number of MAC addresses that can be authenticated on a port via MAC authentication	IC
<code>clear network-access</code>	Clears authenticated MAC addresses from the address table	PE
<code>show network-access</code>	Displays the MAC authentication settings for port interfaces	PE
<code>show network-access mac-address-table</code>	Displays information for entries in the secure MAC address table	PE
<code>show network-access mac-filter</code>	Displays information for entries in the MAC filter tables	PE

network-access aging Use this command to enable aging for authenticated MAC addresses stored in the secure MAC address table. Use the **no** form of this command to disable address aging.

SYNTAX

[no] network-access aging

DEFAULT SETTING

Disabled

COMMAND MODE

Global Configuration

COMMAND USAGE

- ◆ Authenticated MAC addresses are stored as dynamic entries in the switch’s secure MAC address table and are removed when the aging time expires. The address aging time is determined by the `mac-address-table aging-time` command.
- ◆ This parameter applies to authenticated MAC addresses configured by the MAC Address Authentication process described in this section, as

well as to any secure MAC addresses authenticated by 802.1X, regardless of the 802.1X Operation Mode (Single-Host, Multi-Host, or MAC-Based authentication as described on [page 867](#)).

- ◆ The maximum number of secure MAC addresses supported for the switch system is 1024.

EXAMPLE

```
Console(config-if)#network-access aging
Console(config-if)#
```

network-access mac-filter Use this command to add a MAC address into a filter table. Use the **no** form of this command to remove the specified MAC address.

SYNTAX

[no] network-access mac-filter *filter-id*
mac-address *mac-address* [**mask** *mask-address*]

filter-id - Specifies a MAC address filter table. (Range: 1-64)

mac-address - Specifies a MAC address entry.
(Format: xx-xx-xx-xx-xx-xx)

mask - Specifies a MAC address bit mask for a range of addresses.

DEFAULT SETTING

Disabled

COMMAND MODE

Global Configuration

COMMAND USAGE

- ◆ Specified addresses are exempt from network access authentication.
- ◆ This command is different from configuring static addresses with the [mac-address-table static](#) command in that it allows you configure a range of addresses when using a mask, and then to assign these addresses to one or more ports with the [network-access port-mac-filter](#) command.
- ◆ Up to 64 filter tables can be defined.
- ◆ There is no limitation on the number of entries that can entered in a filter table.

EXAMPLE

```
Console(config)#network-access mac-filter 1 mac-address 11-22-33-44-55-66
Console(config)#
```

mac-authentication reauth-time Use this command to set the time period after which a connected MAC address must be re-authenticated. Use the **no** form of this command to restore the default value.

SYNTAX

mac-authentication reauth-time *seconds*

no mac-authentication reauth-time

seconds - The reauthentication time period.
(Range: 120-1000000 seconds)

DEFAULT SETTING

1800

COMMAND MODE

Global Configuration

COMMAND USAGE

- ◆ The reauthentication time is a global setting and applies to all ports.
- ◆ When the reauthentication time expires for a secure MAC address it is reauthenticated with the RADIUS server. During the reauthentication process traffic through the port remains unaffected.

EXAMPLE

```
Console(config)#mac-authentication reauth-time 300  
Console(config)#
```

network-access dynamic-qos Use this command to enable the dynamic QoS feature for an authenticated port. Use the **no** form to restore the default.

SYNTAX

[no] network-access dynamic-qos

DEFAULT SETTING

Disabled

COMMAND MODE

Interface Configuration

COMMAND USAGE

- ◆ The RADIUS server may optionally return dynamic QoS assignments to be applied to a switch port for an authenticated user. The "Filter-ID"

attribute (attribute 11) can be configured on the RADIUS server to pass the following QoS information:

Table 95: Dynamic QoS Profiles

Profile	Attribute Syntax	Example
DiffServ	service-policy-in = <i>policy-map-name</i>	service-policy-in=p1
Rate Limit	rate-limit-input = <i>rate</i> (Kbps)	rate-limit-input=100 (Kbps)
	rate-limit-output = <i>rate</i> (Kbps)	rate-limit-output=200 (Kbps)
802.1p	switchport-priority-default = <i>value</i>	switchport-priority-default=2
IP ACL	ip-access-group-in = <i>ip-acl-name</i>	ip-access-group-in=ipv4acl
IPv6 ACL	ipv6-access-group-in = <i>ipv6-acl-name</i>	ipv6-access-group-in=ipv6acl
MAC ACL	mac-access-group-in = <i>mac-acl-name</i>	mac-access-group-in=macAcl

- ◆ When the last user logs off of a port with a dynamic QoS assignment, the switch restores the original QoS configuration for the port.
- ◆ When a user attempts to log into the network with a returned dynamic QoS profile that is different from users already logged on to the same port, the user is denied access.
- ◆ While a port has an assigned dynamic QoS profile, any manual QoS configuration changes only take effect after all users have logged off of the port.



NOTE: Any configuration changes for dynamic QoS are not saved to the switch configuration file.

EXAMPLE

The following example enables the dynamic QoS feature on port 1.

```
Console(config)#interface ethernet 1/1
Console(config-if)#network-access dynamic-qos
Console(config-if)#
```

**network-access
dynamic-vlan**

Use this command to enable dynamic VLAN assignment for an authenticated port. Use the **no** form to disable dynamic VLAN assignment.

SYNTAX

[no] network-access dynamic-vlan

DEFAULT SETTING

Enabled

COMMAND MODE

Interface Configuration

COMMAND USAGE

- ◆ When enabled, the VLAN identifiers returned by the RADIUS server through the 802.1X authentication process will be applied to the port, providing the VLANs have already been created on the switch. GVRP is not used to create the VLANs.
- ◆ The VLAN settings specified by the first authenticated MAC address are implemented for a port. Other authenticated MAC addresses on the port must have same VLAN configuration, or they are treated as an authentication failure.
- ◆ If dynamic VLAN assignment is enabled on a port and the RADIUS server returns no VLAN configuration, the authentication is still treated as a success, and the host assigned to the default untagged VLAN.
- ◆ When the dynamic VLAN assignment status is changed on a port, all authenticated addresses are cleared from the secure MAC address table.

EXAMPLE

The following example enables dynamic VLAN assignment on port 1.

```
Console(config)#interface ethernet 1/1
Console(config-if)#network-access dynamic-vlan
Console(config-if)#
```

network-access guest-vlan

Use this command to assign all traffic on a port to a guest VLAN when 802.1x authentication or MAC authentication is rejected. Use the **no** form of this command to disable guest VLAN assignment.

SYNTAX

network-access guest-vlan *vlan-id*

no network-access guest-vlan

vlan-id - VLAN ID (Range: 1-4094)

DEFAULT SETTING

Disabled

COMMAND MODE

Interface Configuration

COMMAND USAGE

- ◆ The VLAN to be used as the guest VLAN must be defined and set as active (See the [vlan database](#) command).

- ◆ When used with 802.1X authentication, the intrusion-action must be set for "guest-vlan" to be effective (see the [dot1x intrusion-action](#) command).

EXAMPLE

```
Console(config)#interface ethernet 1/1
Console(config-if)#network-access guest-vlan 25
Console(config-if)#
```

network-access link-detection Use this command to enable link detection for the selected port. Use the **no** form of this command to restore the default.

SYNTAX

[no] network-access link-detection

DEFAULT SETTING

Disabled

COMMAND MODE

Interface Configuration

EXAMPLE

```
Console(config)#interface ethernet 1/1
Console(config-if)#network-access link-detection
Console(config-if)#
```

network-access link-detection link-down Use this command to detect link-down events. When detected, the switch can shut down the port, send an SNMP trap, or both. Use the **no** form of this command to disable this feature.

SYNTAX

**network-access link-detection link-down
action [shutdown | trap | trap-and-shutdown]**

no network-access link-detection

action - Response to take when port security is violated.

shutdown - Disable port only.

trap - Issue SNMP trap message only.

trap-and-shutdown - Issue SNMP trap message and disable the port.

DEFAULT SETTING

Disabled

COMMAND MODE
Interface Configuration

EXAMPLE

```
Console(config)#interface ethernet 1/1
Console(config-if)#network-access link-detection link-down action trap
Console(config-if)#
```

**network-access
link-detection
link-up**

Use this command to detect link-up events. When detected, the switch can shut down the port, send an SNMP trap, or both. Use the **no** form of this command to disable this feature.

SYNTAX

**network-access link-detection link-up
action [shutdown | trap | trap-and-shutdown]**

no network-access link-detection

action - Response to take when port security is violated.

shutdown - Disable port only.

trap - Issue SNMP trap message only.

trap-and-shutdown - Issue SNMP trap message and disable the port.

DEFAULT SETTING

Disabled

COMMAND MODE
Interface Configuration

EXAMPLE

```
Console(config)#interface ethernet 1/1
Console(config-if)#network-access link-detection link-up action trap
Console(config-if)#
```

**network-access
link-detection
link-up-down**

Use this command to detect link-up and link-down events. When either event is detected, the switch can shut down the port, send an SNMP trap, or both. Use the **no** form of this command to disable this feature.

SYNTAX

**network-access link-detection link-up-down
action [shut | trap | trap-and-shutdown]**

no network-access link-detection

action - Response to take when port security is violated.

shutdown - Disable port only.

trap - Issue SNMP trap message only.

trap-and-shutdown - Issue SNMP trap message and disable the port.

DEFAULT SETTING

Disabled

COMMAND MODE

Interface Configuration

EXAMPLE

```
Console(config)#interface ethernet 1/1
Console(config-if)#network-access link-detection link-up-down action trap
Console(config-if)#
```

network-access max-mac-count Use this command to set the maximum number of MAC addresses that can be authenticated on a port interface via all forms of authentication. Use the **no** form of this command to restore the default.

SYNTAX

network-access max-mac-count *count*

no network-access max-mac-count

count - The maximum number of authenticated IEEE 802.1X and MAC addresses allowed. (Range: 0-2048; 0 for unlimited)

DEFAULT SETTING

1024

COMMAND MODE

Interface Configuration

COMMAND USAGE

The maximum number of MAC addresses per port is 1024, and the maximum number of secure MAC addresses supported for the switch system is 1024. When the limit is reached, all new MAC addresses are treated as authentication failures.

EXAMPLE

```
Console(config-if)#network-access max-mac-count 5
Console(config-if)#
```

network-access mode mac-authentication Use this command to enable network access authentication on a port. Use the **no** form of this command to disable network access authentication.

SYNTAX

[no] network-access mode mac-authentication

DEFAULT SETTING

Disabled

COMMAND MODE

Interface Configuration

COMMAND USAGE

- ◆ When enabled on a port, the authentication process sends a Password Authentication Protocol (PAP) request to a configured RADIUS server. The user name and password are both equal to the MAC address being authenticated.
- ◆ On the RADIUS server, PAP user name and passwords must be configured in the MAC address format XX-XX-XX-XX-XX-XX (all in upper case).
- ◆ Authenticated MAC addresses are stored as dynamic entries in the switch secure MAC address table and are removed when the aging time expires. The maximum number of secure MAC addresses supported for the switch system is 1024.
- ◆ Configured static MAC addresses are added to the secure address table when seen on a switch port. Static addresses are treated as authenticated without sending a request to a RADIUS server.
- ◆ MAC authentication, 802.1X, and port security cannot be configured together on the same port. Only one security mechanism can be applied.
- ◆ MAC authentication cannot be configured on trunk ports.
- ◆ When port status changes to down, all MAC addresses are cleared from the secure MAC address table. Static VLAN assignments are not restored.
- ◆ The RADIUS server may optionally return a VLAN identifier list. VLAN identifier list is carried in the "Tunnel-Private-Group-ID" attribute. The VLAN list can contain multiple VLAN identifiers in the format "1u,2t," where "u" indicates untagged VLAN and "t" tagged VLAN. The "Tunnel-Type" attribute should be set to "VLAN," and the "Tunnel-Medium-Type" attribute set to "802."

EXAMPLE

```
Console(config-if)#network-access mode mac-authentication
Console(config-if)#
```

network-access port-mac-filter Use this command to enable the specified MAC address filter. Use the **no** form of this command to disable the specified MAC address filter.

SYNTAX

network-access port-mac-filter *filter-id*

no network-access port-mac-filter

filter-id - Specifies a MAC address filter table. (Range: 1-64)

DEFAULT SETTING

None

COMMAND MODE

Interface Configuration

COMMAND MODE

- ◆ Entries in the MAC address filter table can be configured with the [network-access mac-filter](#) command.
- ◆ Only one filter table can be assigned to a port.

EXAMPLE

```
Console(config)#interface ethernet 1/1
Console(config-if)#network-access port-mac-filter 1
Console(config-if)#
```

mac-authentication intrusion-action Use this command to configure the port response to a host MAC authentication failure. Use the **no** form of this command to restore the default.

SYNTAX

mac-authentication intrusion-action {**block traffic** | **pass traffic**}

no mac-authentication intrusion-action

DEFAULT SETTING

Block Traffic

COMMAND MODE

Interface Configuration

EXAMPLE

```
Console(config-if)#mac-authentication intrusion-action block-traffic
Console(config-if)#
```

mac-authentication max-mac-count Use this command to set the maximum number of MAC addresses that can be authenticated on a port via MAC authentication. Use the **no** form of this command to restore the default.

SYNTAX

mac-authentication max-mac-count *count*

no mac-authentication max-mac-count

count - The maximum number of MAC-authenticated MAC addresses allowed. (Range: 1-1024)

DEFAULT SETTING

1024

COMMAND MODE

Interface Configuration

EXAMPLE

```
Console(config-if)#mac-authentication max-mac-count 32
Console(config-if)#
```

clear network-access Use this command to clear entries from the secure MAC addresses table.

SYNTAX

clear network-access mac-address-table [**static** | **dynamic**]
[**address** *mac-address*] [**interface** *interface*]

static - Specifies static address entries.

dynamic - Specifies dynamic address entries.

mac-address - Specifies a MAC address entry. (Format: xx-xx-xx-xx-xx-xx)

interface - Specifies a port interface.

ethernet *unit/port*

unit - Unit number. (Range: 1)

port - Port number. (Range: 1-28/52)

DEFAULT SETTING

None

COMMAND MODE

Privileged Exec

EXAMPLE

```
Console#clear network-access mac-address-table interface ethernet 1/1
Console#
```

show network-access Use this command to display the MAC authentication settings for port interfaces.

SYNTAX

show network-access [**interface** *interface*]

interface - Specifies a port interface.

ethernet *unit/port*

unit - Unit identifier. (Range: 1)

port - Port number. (Range: 1-28/52)

DEFAULT SETTING

Displays the settings for all interfaces.

COMMAND MODE

Privileged Exec

EXAMPLE

```
Console#show network-access interface ethernet 1/1
Global secure port information
Reauthentication Time           : 1800
MAC Address Aging              : Disabled

Port : 1/1
MAC Authentication              : Disabled
MAC Authentication Intrusion Action : Block traffic
MAC Authentication Maximum MAC Counts : 1024
Maximum MAC Counts             : 1024
Dynamic VLAN Assignment        : Enabled
Dynamic QoS Assignment        : Disabled
MAC Filter ID                  : Disabled
Guest VLAN                     : Disabled
Link Detection                  : Disabled
Detection Mode                 : Link-down
Detection Action                : Trap
Console#
```

show network-access mac-address-table Use this command to display secure MAC address table entries.
SYNTAX

show network-access mac-address-table [**static** | **dynamic**]
[**address** *mac-address* [*mask*]] [**interface** *interface*]
[**sort** {**address** | **interface**}]

static - Specifies static address entries.

dynamic - Specifies dynamic address entries.

mac-address - Specifies a MAC address entry.
(Format: xx-xx-xx-xx-xx-xx)

mask - Specifies a MAC address bit mask for filtering displayed addresses.

interface - Specifies a port interface.

ethernet *unit/port*

unit - Unit identifier. (Range: 1)

port - Port number. (Range: 1-28/52)

sort - Sorts displayed entries by either MAC address or interface.

DEFAULT SETTING

Displays all filters.

COMMAND MODE

Privileged Exec

COMMAND USAGE

When using a bit mask to filter displayed MAC addresses, a 1 means "care" and a 0 means "don't care". For example, a MAC of 00-00-01-02-03-04 and mask FF-FF-FF-00-00-00 would result in all MACs in the range 00-00-01-00-00-00 to 00-00-01-FF-FF-FF to be displayed. All other MACs would be filtered out.

EXAMPLE

```
Console#show network-access mac-address-table
-----
Port  MAC-Address          RADIUS-Server  Attribute  Time
-----
1/1   00-00-01-02-03-04     172.155.120.17  Static     00d06h32m50s
1/1   00-00-01-02-03-05     172.155.120.17  Dynamic    00d06h33m20s
1/1   00-00-01-02-03-06     172.155.120.17  Static     00d06h35m10s
1/3   00-00-01-02-03-07     172.155.120.17  Dynamic    00d06h34m20s

Console#
```

show network-access mac-filter Use this command to display information for entries in the MAC filter tables.

SYNTAX

show network-access mac-filter [*filter-id*]

filter-id - Specifies a MAC address filter table. (Range: 1-64)

DEFAULT SETTING

Displays all filters.

COMMAND MODE

Privileged Exec

EXAMPLE

```

Console#show network-access mac-filter
Filter ID MAC Address      MAC Mask
-----
      1 00-00-01-02-03-08 FF-FF-FF-FF-FF-FF
Console#

```

WEB AUTHENTICATION

Web authentication allows stations to authenticate and access the network in situations where 802.1X or Network Access authentication are infeasible or impractical. The web authentication feature allows unauthenticated hosts to request and receive a DHCP assigned IP address and perform DNS queries. All other traffic, except for HTTP protocol traffic, is blocked. The switch intercepts HTTP protocol traffic and redirects it to a switch-generated web page that facilitates user name and password authentication via RADIUS. Once authentication is successful, the web browser is forwarded on to the originally requested web page. Successful authentication is valid for all hosts connected to the port.



NOTE: RADIUS authentication must be activated and configured for the web authentication feature to work properly (see "[Authentication Sequence](#)" on page 828).

NOTE: Web authentication cannot be configured on trunk ports.

Table 96: Web Authentication

Command	Function	Mode
web-auth login-attempts	Defines the limit for failed web authentication login attempts	GC
web-auth quiet-period	Defines the amount of time to wait after the limit for failed login attempts is exceeded.	GC
web-auth session-timeout	Defines the amount of time a session remains valid	GC

Table 96: Web Authentication (Continued)

Command	Function	Mode
<code>web-auth system-auth-control</code>	Enables web authentication globally for the switch	GC
<code>web-auth</code>	Enables web authentication for an interface	IC
<code>web-auth re-authenticate (Port)</code>	Ends all web authentication sessions on the port and forces the users to re-authenticate	PE
<code>web-auth re-authenticate (IP)</code>	Ends the web authentication session associated with the designated IP address and forces the user to re-authenticate	PE
<code>show web-auth</code>	Displays global web authentication parameters	PE
<code>show web-auth interface</code>	Displays interface-specific web authentication parameters and statistics	PE
<code>show web-auth summary</code>	Displays a summary of web authentication port parameters and statistics	PE

web-auth login-attempts

This command defines the limit for failed web authentication login attempts. After the limit is reached, the switch refuses further login attempts until the quiet time expires. Use the **no** form to restore the default.

SYNTAX

web-auth login-attempts *count*

no web-auth login-attempts

count - The limit of allowed failed login attempts. (Range: 1-3)

DEFAULT SETTING

3 login attempts

COMMAND MODE

Global Configuration

EXAMPLE

```
Console(config)#web-auth login-attempts 2
Console(config)#
```

web-auth quiet-period This command defines the amount of time a host must wait after exceeding the limit for failed login attempts, before it may attempt web authentication again. Use the **no** form to restore the default.

SYNTAX

web-auth quiet-period *time*

no web-auth quiet period

time - The amount of time the host must wait before attempting authentication again. (Range: 1-180 seconds)

DEFAULT SETTING

60 seconds

COMMAND MODE

Global Configuration

EXAMPLE

```
Console(config)#web-auth quiet-period 120
Console(config)#
```

web-auth session-timeout This command defines the amount of time a web-authentication session remains valid. When the session timeout has been reached, the host is logged off and must re-authenticate itself the next time data transmission takes place. Use the **no** form to restore the default.

SYNTAX

web-auth session-timeout *timeout*

no web-auth session timeout

timeout - The amount of time that an authenticated session remains valid. (Range: 300-3600 seconds)

DEFAULT SETTING

3600 seconds

COMMAND MODE

Global Configuration

EXAMPLE

```
Console(config)#web-auth session-timeout 1800
Console(config)#
```

web-auth system-auth-control This command globally enables web authentication for the switch. Use the **no** form to restore the default.

SYNTAX

[no] web-auth system-auth-control

DEFAULT SETTING

Disabled

COMMAND MODE

Global Configuration

COMMAND USAGE

Both **web-auth system-auth-control** for the switch and **web-auth** for an interface must be enabled for the web authentication feature to be active.

EXAMPLE

```
Console(config)#web-auth system-auth-control
Console(config)#
```

web-auth This command enables web authentication for an interface. Use the **no** form to restore the default.

SYNTAX

[no] web-auth

DEFAULT SETTING

Disabled

COMMAND MODE

Interface Configuration

COMMAND USAGE

Both **web-auth system-auth-control** for the switch and **web-auth** for a port must be enabled for the web authentication feature to be active.

EXAMPLE

```
Console(config-if)#web-auth
Console(config-if)#
```

web-auth re-authenticate (Port) This command ends all web authentication sessions connected to the port and forces the users to re-authenticate.

SYNTAX

web-auth re-authenticate interface *interface*

interface - Specifies a port interface.

ethernet *unit/port*

unit - This is unit 1.

port - Port number. (Range: 1-28/52)

DEFAULT SETTING

None

COMMAND MODE

Privileged Exec

EXAMPLE

```
Console#web-auth re-authenticate interface ethernet 1/2
Console#
```

web-auth re-authenticate (IP) This command ends the web authentication session associated with the designated IP address and forces the user to re-authenticate.

SYNTAX

web-auth re-authenticate interface *interface ip*

interface - Specifies a port interface.

ethernet *unit/port*

unit - This is unit 1.

port - Port number. (Range: 1-28/52)

ip - IPv4 formatted IP address

DEFAULT SETTING

None

COMMAND MODE

Privileged Exec

EXAMPLE

```
Console#web-auth re-authenticate interface ethernet 1/2 192.168.1.5
Console#
```

show web-auth This command displays global web authentication parameters.

COMMAND MODE
Privileged Exec

EXAMPLE

```
Console#show web-auth
Global Web-Auth Parameters
  System Auth Control      : Enabled
  Session Timeout         : 3600
  Quiet Period            : 60
  Max Login Attempts      : 3
Console#
```

show web-auth interface This command displays interface-specific web authentication parameters and statistics.

SYNTAX

show web-auth interface *interface*

interface - Specifies a port interface.

ethernet *unit/port*

unit - This is unit 1.

port - Port number. (Range: 1-28/52)

COMMAND MODE
Privileged Exec

EXAMPLE

```
Console#show web-auth interface ethernet 1/2
Web Auth Status      : Enabled

Host Summary

IP address      Web-Auth-State Remaining-Session-Time
-----
1.1.1.1         Authenticated   295
1.1.1.2         Authenticated   111
Console#
```

show web-auth summary This command displays a summary of web authentication port parameters and statistics.

COMMAND MODE
Privileged Exec

EXAMPLE

```

Console#show web-auth summary
Global Web-Auth Parameters
  System Auth Control      : Enabled
Port      Status           Authenticated Host Count
----      -
1/ 1      Disabled            0
1/ 2      Enabled             8
1/ 3      Disabled            0
1/ 4      Disabled            0
1/ 5      Disabled            0
:

```

DHCPv4 SNOOPING

DHCPv4 snooping allows a switch to protect a network from rogue DHCPv4 servers or other devices which send port-related information to a DHCPv4 server. This information can be useful in tracking an IP address back to a physical port. This section describes commands used to configure DHCPv4 snooping.

Table 97: DHCP Snooping Commands

Command	Function	Mode
<code>ip dhcp snooping</code>	Enables DHCP snooping globally	GC
<code>ip dhcp snooping information option</code>	Enables or disables the use of DHCP Option 82 information, and specifies frame format for the remote-id	GC
<code>ip dhcp snooping information policy</code>	Sets the information option policy for DHCP client packets that include Option 82 information	GC
<code>ip dhcp snooping limit rate</code>	Sets the maximum number of DHCP packets that can be trapped for DHCP snooping	GC
<code>ip dhcp snooping verify mac-address</code>	Verifies the client's hardware address stored in the DHCP packet against the source MAC address in the Ethernet header	GC
<code>ip dhcp snooping vlan</code>	Enables DHCP snooping on the specified VLAN	GC
<code>ip dhcp snooping information option circuit-id</code>	Enables or disables the use of DHCP Option 82 information circuit-id suboption	IC
<code>ip dhcp snooping trust</code>	Configures the specified interface as trusted	IC
<code>clear ip dhcp snooping binding</code>	Clears DHCP snooping binding table entries from RAM	PE
<code>clear ip dhcp snooping database flash</code>	Removes all dynamically learned snooping entries from flash memory.	PE

Table 97: DHCP Snooping Commands (Continued)

Command	Function	Mode
<code>ip dhcp snooping database flash</code>	Writes all dynamically learned snooping entries to flash memory	PE
<code>show ip dhcp snooping</code>	Shows the DHCP snooping configuration settings	PE
<code>show ip dhcp snooping binding</code>	Shows the DHCP snooping binding table entries	PE

ip dhcp snooping This command enables DHCP snooping globally. Use the **no** form to restore the default setting.

SYNTAX

[no] ip dhcp snooping

DEFAULT SETTING

Disabled

COMMAND MODE

Global Configuration

COMMAND USAGE

- ◆ Network traffic may be disrupted when malicious DHCP messages are received from an outside source. DHCP snooping is used to filter DHCP messages received on an unsecure interface from outside the network or fire wall. When DHCP snooping is enabled globally by this command, and enabled on a VLAN interface by the `ip dhcp snooping vlan` command, DHCP messages received on an untrusted interface (as specified by the `no ip dhcp snooping trust` command) from a device not listed in the DHCP snooping table will be dropped.
- ◆ When enabled, DHCP messages entering an untrusted interface are filtered based upon dynamic entries learned via DHCP snooping.
- ◆ Table entries are only learned for trusted interfaces. Each entry includes a MAC address, IP address, lease time, VLAN identifier, and port identifier.
- ◆ When DHCP snooping is enabled, the rate limit for the number of DHCP messages that can be processed by the switch is 100 packets per second. Any DHCP packets in excess of this limit are dropped.
- ◆ Filtering rules are implemented as follows:
 - If global DHCP snooping is disabled, all DHCP packets are forwarded.
 - If DHCP snooping is enabled globally, and also enabled on the VLAN where the DHCP packet is received, all DHCP packets are forwarded for a *trusted* port. If the received packet is a DHCP ACK message, a dynamic DHCP snooping entry is also added to the binding table.

- If DHCP snooping is enabled globally, and also enabled on the VLAN where the DHCP packet is received, but the port is *not trusted*, it is processed as follows:
 - If the DHCP packet is a reply packet from a DHCP server (including OFFER, ACK or NAK messages), the packet is dropped.
 - If the DHCP packet is from a client, such as a DECLINE or RELEASE message, the switch forwards the packet only if the corresponding entry is found in the binding table.
 - If the DHCP packet is from client, such as a DISCOVER, REQUEST, INFORM, DECLINE or RELEASE message, the packet is forwarded if MAC address verification is disabled (as specified by the `ip dhcp snooping verify mac-address` command). However, if MAC address verification is enabled, then the packet will only be forwarded if the client's hardware address stored in the DHCP packet is the same as the source MAC address in the Ethernet header.
 - If the DHCP packet is not a recognizable type, it is dropped.
- If a DHCP packet from a client passes the filtering criteria above, it will only be forwarded to trusted ports in the same VLAN.
- If a DHCP packet is from server is received on a trusted port, it will be forwarded to both trusted and untrusted ports in the same VLAN.
- ◆ If DHCP snooping is globally disabled, all dynamic bindings are removed from the binding table.
- ◆ *Additional considerations when the switch itself is a DHCP client* – The port(s) through which the switch submits a client request to the DHCP server must be configured as trusted (using the `ip dhcp snooping trust` command). Note that the switch will not add a dynamic entry for itself to the binding table when it receives an ACK message from a DHCP server. Also, when the switch sends out DHCP client packets for itself, no filtering takes place. However, when the switch receives any messages from a DHCP server, any packets received from untrusted ports are dropped.

EXAMPLE

This example enables DHCP snooping globally for the switch.

```
Console(config)#ip dhcp snooping
Console(config)#
```

RELATED COMMANDS

[ip dhcp snooping vlan \(921\)](#)
[ip dhcp snooping trust \(923\)](#)

ip dhcp snooping information option

This command enables the use of DHCP Option 82 information for the switch, and specifies the frame format to use for the remote-id when Option 82 information is generated by the switch. Use the **no** form without any keywords to disable this function, the **no** form with the **encode no-subtype** keyword to enable use of sub-type and sub-length in CID/RID fields, or the **no** form with the **remote-id** keyword to set the remote ID to the switch's MAC address encoded in hexadecimal.

SYNTAX

ip dhcp snooping information option

[**encode no-subtype**]
[**remote-id** {**ip-address** [**encode** {**ascii** | **hex**}] |
mac-address [**encode** {**ascii** | **hex**}] |
string *string*}]

no ip dhcp snooping information option [**encode no-subtype**] [**remote-id** [**ip-address** **encode**] | [**mac-address** **encode**]]

encode no-subtype - Disables use of sub-type and sub-length fields in circuit-ID (CID) and remote-ID (RID) in Option 82 information.

mac-address - Inserts a MAC address in the remote ID sub-option for the DHCP snooping agent (that is, the MAC address of the switch's CPU).

ip-address - Inserts an IP address in the remote ID sub-option for the DHCP snooping agent (that is, the IP address of the management interface).

encode - Indicates encoding in ASCII or hexadecimal.

string - An arbitrary string inserted into the remote identifier field. (Range: 1-32 characters)

DEFAULT SETTING

Option 82: Disabled

CID/RID sub-type: Enabled

Remote ID: MAC address (hexadecimal)

COMMAND MODE

Global Configuration

COMMAND USAGE

- ◆ DHCP provides a relay mechanism for sending information about the switch and its DHCP clients to the DHCP server. Known as DHCP Option 82, it allows compatible DHCP servers to use the information when assigning IP addresses, or to set other services or policies for clients.
- ◆ When the DHCP Snooping Information Option 82 is enabled, the requesting client (or an intermediate relay agent that has used the information fields to describe itself) can be identified in the DHCP request packets forwarded by the switch and in reply packets sent back from the DHCP server.

- ◆ When the DHCP Snooping Information Option 82 is enabled, clients can be identified by the switch port to which they are connected rather than just their MAC address. DHCP client-server exchange messages are then forwarded directly between the server and client without having to flood them to the entire VLAN.
- ◆ DHCP snooping must be enabled for the DHCP Option 82 information to be inserted into packets. When enabled, the switch will only add/remove option 82 information in incoming DHCP packets but not relay them. Packets are processed as follows:
 - If an incoming packet is a DHCP request packet with option 82 information, it will modify the option 82 information according to settings specified with `ip dhcp snooping information policy` command.
 - If an incoming packet is a DHCP request packet without option 82 information, enabling the DHCP snooping information option will add option 82 information to the packet.
 - If an incoming packet is a DHCP reply packet with option 82 information, enabling the DHCP snooping information option will remove option 82 information from the packet.

EXAMPLE

This example enables the DHCP Snooping Information Option.

```
Console(config)#ip dhcp snooping information option
Console(config)#
```

ip dhcp snooping information policy

This command sets the DHCP snooping information option policy for DHCP client packets that include Option 82 information. Use the **no** form to restore the default setting.

SYNTAX

ip dhcp snooping information policy {drop | keep | replace}

no ip dhcp snooping information policy

drop - Drops the client's request packet instead of relaying it.

keep - Retains the Option 82 information in the client request, and forwards the packets to trusted ports.

replace - Replaces the Option 82 information circuit-id and remote-id fields in the client's request with information about the relay agent itself, inserts the relay agent's address (when DHCP snooping is enabled), and forwards the packets to trusted ports.

DEFAULT SETTING

replace

COMMAND MODE

Global Configuration

COMMAND USAGE

When the switch receives DHCP packets from clients that already include DHCP Option 82 information, the switch can be configured to set the action policy for these packets. The switch can either drop the DHCP packets, keep the existing information, or replace it with the switch's relay information.

EXAMPLE

```
Console(config)#ip dhcp snooping information policy drop
Console(config)#
```

ip dhcp snooping limit rate This command sets the maximum number of DHCP packets that can be trapped by the switch for DHCP snooping. Use the **no** form to restore the default setting.

SYNTAX

ip dhcp snooping limit rate *rate*

no dhcp snooping limit rate

rate - The maximum number of DHCP packets that may be trapped for DHCP snooping. (Range: 1-2048 packets/second)

DEFAULT SETTING

Disabled

COMMAND MODES

Global Configuration

EXAMPLE

This example sets the DHCP snooping rate limit to 100 packets per second.

```
Console(config)#ip dhcp snooping limit rate 100
Console(config)#
```

ip dhcp snooping verify mac-address This command verifies the client's hardware address stored in the DHCP packet against the source MAC address in the Ethernet header. Use the **no** form to disable this function.

SYNTAX

[no] ip dhcp snooping verify mac-address

DEFAULT SETTING

Enabled

COMMAND MODE

Global Configuration

COMMAND USAGE

If MAC address verification is enabled, and the source MAC address in the Ethernet header of the packet is not same as the client's hardware address in the DHCP packet, the packet is dropped.

EXAMPLE

This example enables MAC address verification.

```
Console(config)#ip dhcp snooping verify mac-address
Console(config)#
```

RELATED COMMANDS

[ip dhcp snooping \(916\)](#)
[ip dhcp snooping vlan \(921\)](#)
[ip dhcp snooping trust \(923\)](#)

ip dhcp snooping vlan This command enables DHCP snooping on the specified VLAN. Use the **no** form to restore the default setting.

SYNTAX

[no] ip dhcp snooping vlan *vlan-id*

vlan-id - ID of a configured VLAN (Range: 1-4094)

DEFAULT SETTING

Disabled

COMMAND MODE

Global Configuration

COMMAND USAGE

- ◆ When DHCP snooping is enabled globally using the [ip dhcp snooping](#) command, and enabled on a VLAN with this command, DHCP packet filtering will be performed on any untrusted ports within the VLAN as specified by the [ip dhcp snooping trust](#) command.
- ◆ When the DHCP snooping is globally disabled, DHCP snooping can still be configured for specific VLANs, but the changes will not take effect until DHCP snooping is globally re-enabled.
- ◆ When DHCP snooping is globally enabled, and then disabled on a VLAN, all dynamic bindings learned for this VLAN are removed from the binding table.

EXAMPLE

This example enables DHCP snooping for VLAN 1.

```
Console(config)#ip dhcp snooping vlan 1
Console(config)#
```

RELATED COMMANDS

- [ip dhcp snooping \(916\)](#)
- [ip dhcp snooping trust \(923\)](#)

ip dhcp snooping information option circuit-id

This command enables the use of DHCP Option 82 information circuit-id suboption. Use the **no** form to disable this feature.

SYNTAX

- ip dhcp snooping information option circuit-id string** *string*
- no dhcp snooping information option circuit-id**

string - An arbitrary string inserted into the circuit identifier field.
(Range: 1-32 characters)

DEFAULT SETTING

Disabled

COMMAND MODE

Interface Configuration (Ethernet, Port Channel)

COMMAND USAGE

- ◆ DHCP provides a relay mechanism for sending information about the switch and its DHCP clients to the DHCP server. DHCP Option 82 allows compatible DHCP servers to use the information when assigning IP addresses, to set other services or policies for clients. For more information of this process, refer to the Command Usage section under the [ip dhcp snooping information option](#) command.
- ◆ Option 82 information generated by the switch is based on TR-101 syntax as shown below:

Table 98: Option 82 information

82	3-69	1	1-67	x1	x2	x3	x4	x5	x63
opt82	opt-len	sub-opt1	string-len						R-124 string

The circuit identifier used by this switch starts at sub-option1 and goes to the end of the R-124 string. The R-124 string includes the following information:

- sub-type - Distinguishes different types of circuit IDs.
- sub-length - Length of the circuit ID type

- access node identifier - ASCII string. Default is the MAC address of the switch's CPU. This field is set by the `ip dhcp snooping information option` command,
 - eth - The second field is the fixed string "eth"
 - slot - The slot represents the stack unit for this system.
 - port - The port which received the DHCP request. If the packet arrives over a trunk, the value is the ifIndex of the trunk.
 - vlan - Tag of the VLAN which received the DHCP request.
- Note that the sub-type and sub-length fields can be enabled or disabled using the `ip dhcp snooping information option` command.
- The `ip dhcp snooping information option circuit-id` command can be used to modify the default settings described above.

EXAMPLE

This example sets the DHCP Snooping Information circuit-id suboption string.

```
Console(config)#interface ethernet 1/1
Console(config-if)#ip dhcp snooping information option circuit-id string mv2
Console(config-if)#
```

ip dhcp snooping trust This command configures the specified interface as trusted. Use the **no** form to restore the default setting.

SYNTAX

[no] ip dhcp snooping trust

DEFAULT SETTING

All interfaces are untrusted

COMMAND MODE

Interface Configuration (Ethernet, Port Channel)

COMMAND USAGE

- ◆ A trusted interface is an interface that is configured to receive only messages from within the network. An untrusted interface is an interface that is configured to receive messages from outside the network or fire wall.
- ◆ Set all ports connected to DHCP servers within the local network or fire wall to trusted, and all other ports outside the local network or fire wall to untrusted.
- ◆ When DHCP snooping is enabled globally using the `ip dhcp snooping` command, and enabled on a VLAN with `ip dhcp snooping vlan` command, DHCP packet filtering will be performed on any untrusted

ports within the VLAN according to the default status, or as specifically configured for an interface with the **no ip dhcp snooping trust** command.

- ◆ When an untrusted port is changed to a trusted port, all the dynamic DHCP snooping bindings associated with this port are removed.
- ◆ *Additional considerations when the switch itself is a DHCP client* – The port(s) through which it submits a client request to the DHCP server must be configured as trusted.

EXAMPLE

This example sets port 5 to untrusted.

```
Console(config)#interface ethernet 1/5
Console(config-if)#no ip dhcp snooping trust
Console(config-if)#
```

RELATED COMMANDS

[ip dhcp snooping \(916\)](#)
[ip dhcp snooping vlan \(921\)](#)

clear ip dhcp snooping binding

This command clears DHCP snooping binding table entries from RAM. Use this command without any optional keywords to clear all entries from the binding table.

SYNTAX

clear ip dhcp snooping binding [*mac-address* **vlan** *vlan-id*]

mac-address - Specifies a MAC address entry.
(Format: xx-xx-xx-xx-xx-xx)

vlan-id - ID of a configured VLAN (Range: 1-4094)

COMMAND MODE

Privileged Exec

EXAMPLE

```
Console#clear ip dhcp snooping binding 11-22-33-44-55-66 vlan 1
Console#
```

clear ip dhcp snooping database flash

This command removes all dynamically learned snooping entries from flash memory.

COMMAND MODE

Privileged Exec

EXAMPLE

```
Console#clear ip dhcp snooping database flash
Console#
```

ip dhcp snooping database flash This command writes all dynamically learned snooping entries to flash memory.

COMMAND MODE

Privileged Exec

COMMAND USAGE

This command can be used to store the currently learned dynamic DHCP snooping entries to flash memory. These entries will be restored to the snooping table when the switch is reset. However, note that the lease time shown for a dynamic entry that has been restored from flash memory will no longer be valid.

EXAMPLE

```
Console#ip dhcp snooping database flash
Console#
```

show ip dhcp snooping This command shows the DHCP snooping configuration settings.

COMMAND MODE

Privileged Exec

EXAMPLE

```
Console#show ip dhcp snooping
Global DHCP Snooping Status: disabled
DHCP Snooping Information Option Status: disabled
DHCP Snooping Information Option Sub-option Format: extra subtype included
DHCP Snooping Information Option Remote ID: MAC Address (hex encoded)
DHCP Snooping Information Policy: replace
DHCP Snooping is configured on the following VLANs:

Verify Source MAC-Address: enabled
DHCP Snooping rate limit: unlimited
Interface   Trusted   Circuit-ID mode  Circuit-ID Value
-----
Eth 1/1     No        Vlan-Unit-Port  ---
Eth 1/2     No        Vlan-Unit-Port  ---
Eth 1/3     No        Vlan-Unit-Port  ---
Eth 1/4     No        Vlan-Unit-Port  ---
Eth 1/5     No        Vlan-Unit-Port  ---
:
:
```

show ip dhcp snooping binding

This command shows the DHCP snooping binding table entries.

COMMAND MODE
Privileged Exec

EXAMPLE

```

Console#show ip dhcp snooping binding
MAC Address      IP Address      Lease(sec)  Type           VLAN  Interface
-----
11-22-33-44-55-66 192.168.0.99    0           Dynamic-DHCPSNP  1    Eth 1/5
Console#
    
```

DHCPv6 SNOOPING

DHCPv6 snooping allows a switch to protect a network from rogue DHCPv6 servers or other devices which send port-related information to a DHCPv6 server. This information can be useful in tracking an IP address back to a physical port. This section describes commands used to configure DHCPv6 snooping.

Table 99: DHCP Snooping Commands

Command	Function	Mode
<code>ipv6 dhcp snooping</code>	Enables DHCPv6 snooping globally	GC
<code>ipv6 dhcp snooping option remote-id</code>	Enables insertion of DHCPv6 Option 37 relay agent remote-id	GC
<code>ipv6 dhcp snooping option remote-id policy</code>	Sets the information option policy for DHCPv6 client packets that include Option 37 information	GC
<code>ipv6 dhcp snooping vlan</code>	Enables DHCPv6 snooping on the specified VLAN	GC
<code>ipv6 dhcp snooping max-binding</code>	Sets the maximum number of entries which can be stored in the binding database for an interface	IC
<code>ipv6 dhcp snooping trust</code>	Configures the specified interface as trusted	IC
<code>clear ipv6 dhcp snooping binding</code>	Clears DHCPv6 snooping binding table entries from RAM	PE
<code>clear ipv6 dhcp snooping database flash</code>	Removes all dynamically learned snooping entries from flash memory.	PE
<code>show ipv6 dhcp snooping</code>	Shows the DHCPv6 snooping configuration settings	PE
<code>show ipv6 dhcp snooping binding</code>	Shows the DHCPv6 snooping binding table entries	PE
<code>show ipv6 dhcp snooping statistics</code>	Shows statistics for DHCPv6 snooping client, server and relay packets	PE

ipv6 dhcp snooping This command enables DHCPv6 snooping globally. Use the **no** form to restore the default setting.

SYNTAX

[no] ipv6 dhcp snooping

DEFAULT SETTING

Disabled

COMMAND MODE

Global Configuration

COMMAND USAGE

- ◆ Network traffic may be disrupted when malicious DHCPv6 messages are received from an outside source. DHCPv6 snooping is used to filter DHCPv6 messages received on an unsecure interface from outside the network or fire wall. When DHCPv6 snooping is enabled globally by this command, and enabled on a VLAN interface by the **ipv6 dhcp snooping vlan** command, DHCP messages received on an untrusted interface (as specified by the **no ipv6 dhcp snooping trust** command) from a device not listed in the DHCPv6 snooping table will be dropped.
- ◆ When enabled, DHCPv6 messages entering an untrusted interface are filtered based upon dynamic entries learned via DHCPv6 snooping.
- ◆ Table entries are only learned for trusted interfaces. Each entry includes a MAC address, IPv6 address, lease time, binding type, VLAN identifier, and port identifier.
- ◆ When DHCPv6 snooping is enabled, the rate limit for the number of DHCPv6 messages that can be processed by the switch is 100 packets per second. Any DHCPv6 packets in excess of this limit are dropped.
- ◆ Filtering rules are implemented as follows:
 - If global DHCPv6 snooping is disabled, all DHCPv6 packets are forwarded.
 - If DHCPv6 snooping is enabled globally, and also enabled on the VLAN where the DHCPv6 packet is received, DHCPv6 packets are forwarded for a *trusted* port as described below.
 - If DHCPv6 snooping is enabled globally, and also enabled on the VLAN where the DHCP packet is received, but the port is *not trusted*, DHCP packets are processed according to message type as follows:

DHCP Client Packet

- Request: Update entry in binding cache, recording client's DHCPv6 Unique Identifier (DUID), server's DUID, Identity Association (IA) type, IA Identifier, and address (4 message exchanges to get IPv6 address), and forward to trusted port.

- Solicit: Add new entry in binding cache, recording client's DUID, IA type, IA ID (2 message exchanges to get IPv6 address with rapid commit option, otherwise 4 message exchanges), and forward to trusted port.
- Decline: If no matching entry is found in binding cache, drop this packet.
- Renew, Rebind, Release, Confirm: If no matching entry is found in binding cache, drop this packet.
- If the DHCPv6 packet is not a recognizable type, it is dropped.

If a DHCPv6 packet from a client passes the filtering criteria above, it will only be forwarded to trusted ports in the same VLAN.

DHCP Server Packet

- If a DHCP server packet is received on an *untrusted* port, drop this packet and add a log entry in the system.
 - If a DHCPv6 Reply packet is received from a server on a *trusted* port, it will be processed in the following manner:
 - A.** Check if IPv6 address in IA option is found in binding table:
 - If yes, continue to C.
 - If not, continue to B.
 - B.** Check if IPv6 address in IA option is found in binding cache:
 - If yes, continue to C.
 - If not, check failed, and forward packet to trusted port.
 - C.** Check status code in IA option:
 - If successful, and entry is in binding table, update lease time and forward to original destination.
 - If successful, and entry is in binding cache, move entry from binding cache to binding table, update lease time and forward to original destination.
 - Otherwise, remove binding entry. and check failed.
 - If a DHCPv6 Relay packet is received, check the relay message option in Relay-Forward or Relay-Reply packet, and process client and server packets as described above.
- ◆ If DHCPv6 snooping is globally disabled, all dynamic bindings are removed from the binding table.
 - ◆ *Additional considerations when the switch itself is a DHCPv6 client* – The port(s) through which the switch submits a client request to the DHCPv6 server must be configured as trusted (using the `ipv6 dhcp snooping trust` command). Note that the switch will not add a dynamic entry for itself to the binding table when it receives an ACK message from a DHCPv6 server. Also, when the switch sends out DHCPv6 client packets for itself, no filtering takes place. However, when the switch receives any messages from a DHCPv6 server, any packets received from untrusted ports are dropped.

EXAMPLE

This example enables DHCPv6 snooping globally for the switch.

```
Console(config)#ipv6 dhcp snooping
Console(config)#
```

RELATED COMMANDS

[ipv6 dhcp snooping vlan \(931\)](#)

[ipv6 dhcp snooping trust \(932\)](#)

**ipv6 dhcp snooping
option remote-id**

This command enables the insertion of remote-id option 37 information into DHCPv6 client messages. Remote-id option information such as the port attached to the client, DUID, and VLAN ID is used by the DHCPv6 server to assign preassigned configuration data specific to the DHCPv6 client. Use the **no** form of the command to disable this function.

SYNTAX

[no] **ipv6 dhcp snooping option remote-id**

DEFAULT SETTING

Disabled

COMMAND MODE

Global Configuration

COMMAND USAGE

- ◆ DHCPv6 provides a relay mechanism for sending information about the switch and its DHCPv6 clients to the DHCPv6 server. Known as DHCPv6 Option 37, it allows compatible DHCPv6 servers to use the information when assigning IP addresses, or to set other services or policies for clients.
- ◆ When DHCPv6 Snooping Information Option 37 is enabled, the requesting client (or an intermediate relay agent that has used the information fields to describe itself) can be identified in the DHCPv6 request packets forwarded by the switch and in reply packets sent back from the DHCPv6 server.
- ◆ When the DHCPv6 Snooping Option 37 is enabled, clients can be identified by the switch port to which they are connected rather than just their MAC address. DHCPv6 client-server exchange messages are then forwarded directly between the server and client without having to flood them to the entire VLAN.
- ◆ DHCPv6 snooping must be enabled for the DHCPv6 Option 37 information to be inserted into packets. When enabled, the switch will

either drop, keep or remove option 37 information in incoming DHCPv6 packets. Packets are processed as follows:

- If an incoming packet is a DHCPv6 request packet with option 37 information, it will modify the option 37 information according to settings specified with `ipv6 dhcp snooping option remote-id policy` command.
 - If an incoming packet is a DHCPv6 request packet without option 37 information, enabling the DHCPv6 snooping information option will add option 37 information to the packet.
 - If an incoming packet is a DHCPv6 reply packet with option 37 information, enabling the DHCPv6 snooping information option will remove option 37 information from the packet.
- ◆ When this switch inserts Option 37 information in DHCPv6 client request packets, the switch's MAC address (hexadecimal) is used for the remote ID.

EXAMPLE

This example enables the DHCPv6 Snooping Remote-ID Option.

```
Console(config)#ipv6 dhcp snooping option remote-id
Console(config)#
```

ipv6 dhcp snooping option remote-id policy

This command sets the remote-id option policy for DHCPv6 client packets that include Option 37 information. Use the **no** form to disable this function.

SYNTAX

ipv6 dhcp snooping option remote-id policy {drop | keep | replace}

no ipv6 dhcp snooping option remote-id policy

drop - Drops the client's request packet instead of relaying it.

keep - Retains the Option 37 information in the client request, and forwards the packets to trusted ports.

replace - Replaces the Option 37 remote-ID in the client's request with the relay agent's remote-ID (when DHCPv6 snooping is enabled), and forwards the packets to trusted ports.

DEFAULT SETTING

drop

COMMAND MODE

Global Configuration

COMMAND USAGE

When the switch receives DHCPv6 packets from clients that already include DHCP Option 37 information, the switch can be configured to set the action policy for these packets. The switch can either drop the DHCPv6 packets, keep the existing information, or replace it with the switch's relay agent information.

EXAMPLE

This example configures the switch to keep existing remote-id option 37 information within DHCPv6 client packets and forward it.

```
Console(config)#ipv6 dhcp snooping option remote-id policy replace
Console(config)#
```

**ipv6 dhcp snooping
vlan**

This command enables DHCPv6 snooping on the specified VLAN. Use the **no** form to restore the default setting.

SYNTAX

[no] ipv6 dhcp snooping vlan {*vlan-id* | *vlan-range*}

vlan-id - ID of a configured VLAN (Range: 1-4094)

vlan-range - A consecutive range of VLANs indicated by the use a hyphen, or a random group of VLANs with each entry separated by a comma.

DEFAULT SETTING

Disabled

COMMAND MODE

Global Configuration

COMMAND USAGE

- ◆ When DHCPv6 snooping enabled globally using the [ipv6 dhcp snooping](#) command, and enabled on a VLAN with this command, DHCPv6 packet filtering will be performed on any untrusted ports within the VLAN as specified by the [ipv6 dhcp snooping trust](#) command.
- ◆ When the DHCPv6 snooping is globally disabled, DHCPv6 snooping can still be configured for specific VLANs, but the changes will not take effect until DHCPv6 snooping is globally re-enabled.
- ◆ When DHCPv6 snooping is enabled globally, and then disabled on a VLAN, all dynamic bindings learned for this VLAN are removed from the binding table.

EXAMPLE

This example enables DHCPv6 snooping for VLAN 1.

```
Console(config)#ipv6 dhcp snooping vlan 1
Console(config)#
```

RELATED COMMANDS

[ipv6 dhcp snooping \(927\)](#)

[ipv6 dhcp snooping trust \(932\)](#)

ipv6 dhcp snooping max-binding

This command sets the maximum number of entries which can be stored in the binding database for an interface. Use the **no** form to restore the default setting.

SYNTAX

ipv6 dhcp snooping max-binding *count*

no ipv6 dhcp snooping max-binding

count - Maximum number of entries. (Range: 1-5)

DEFAULT SETTING

5

COMMAND MODE

Interface Configuration (Ethernet, Port Channel)

EXAMPLE

This example sets the maximum number of binding entries to 1.

```
Console(config)#interface ethernet 1/1
Console(config-if)#ipv6 dhcp snooping max-binding 1
Console(config-if)#
```

ipv6 dhcp snooping trust

This command configures the specified interface as trusted. Use the **no** form to restore the default setting.

SYNTAX

[no] ipv6 dhcp snooping trust

DEFAULT SETTING

All interfaces are untrusted

COMMAND MODE

Interface Configuration (Ethernet, Port Channel)

COMMAND USAGE

- ◆ A trusted interface is an interface that is configured to receive only messages from within the network. An untrusted interface is an interface that is configured to receive messages from outside the network or fire wall.
- ◆ Set all ports connected to DHCPv6 servers within the local network or fire wall to trusted, and all other ports outside the local network or fire wall to untrusted.
- ◆ When DHCPv6 snooping is enabled globally using the `ipv6 dhcp snooping` command, and enabled on a VLAN with `ipv6 dhcp snooping vlan` command, DHCPv6 packet filtering will be performed on any untrusted ports within the VLAN according to the default status, or as specifically configured for an interface with the **no ipv6 dhcp snooping trust** command.
- ◆ When an untrusted port is changed to a trusted port, all the dynamic DHCPv6 snooping bindings associated with this port are removed.
- ◆ *Additional considerations when the switch itself is a DHCPv6 client* – The port(s) through which it submits a client request to the DHCPv6 server must be configured as trusted.

EXAMPLE

This example sets port 5 to untrusted.

```
Console(config)#interface ethernet 1/5
Console(config-if)#no ipv6 dhcp snooping trust
Console(config-if)#
```

RELATED COMMANDS

[ipv6 dhcp snooping \(927\)](#)
[ipv6 dhcp snooping vlan \(931\)](#)

clear ipv6 dhcp snooping binding

This command clears DHCPv6 snooping binding table entries from RAM. Use this command without any optional keywords to clear all entries from the binding table.

SYNTAX

clear ipv6 dhcp snooping binding [*mac-address ipv6-address*]

mac-address - Specifies a MAC address entry.
 (Format: xx-xx-xx-xx-xx-xx)

ipv6-address - Corresponding IPv6 address. This address must be entered according to RFC 2373 "IPv6 Addressing Architecture," using 8 colon-separated 16-bit hexadecimal values. One double colon may be used in the address to indicate the appropriate number of zeros required to fill the undefined fields.

COMMAND MODE
Privileged Exec

EXAMPLE

```
Console(config)#clear ipv6 dhcp snooping binding 00-12-cf-01-02-03 2001::1  
Console(config)#
```

**clear ipv6 dhcp
snooping database
flash**

This command removes all dynamically learned snooping entries from flash memory.

COMMAND MODE
Privileged Exec

EXAMPLE

```
Console(config)#clear ipv6 dhcp snooping database flash  
Console(config)#
```

**show ipv6 dhcp
snooping**

This command shows the DHCPv6 snooping configuration settings.

COMMAND MODE
Privileged Exec

EXAMPLE

```
Console#show ipv6 dhcp snooping  
Global DHCPv6 Snooping status: disabled  
DHCPv6 Snooping remote-id option status: disabled  
DHCPv6 Snooping remote-id policy: drop  
DHCPv6 Snooping is configured on the following VLANs:  
  1,  
Interface           Trusted           Max-binding   Current-binding  
-----           -  
Eth 1/1             No                5              0  
Eth 1/2             No                5              0  
Eth 1/3             No                5              0  
Eth 1/4             No                5              0  
Eth 1/5             Yes               5              0  
.  
.  
.
```

show ipv6 dhcp snooping binding

This command shows the DHCPv6 snooping binding table entries.

COMMAND MODE
Privileged Exec

EXAMPLE

```

Console#show ipv6 dhcp snooping binding
NA - Non-temporary address
TA - Temporary address
-----
Link-layer Address: 00-13-49-aa-39-26
IPv6 Address                               Lifetime  VLAN Port  Type
-----
2001:b021:1435:5612:ab3c:6792:a452:6712    2591998   1 Eth 1/5  NA
-----
Link-layer Address: 00-12-cf-01-02-03
IPv6 Address                               Lifetime  VLAN Port  Type
-----
                                         2001:b000::1  2591912   1 Eth 1/3  NA
Console#
    
```

show ipv6 dhcp snooping statistics

This command shows statistics for DHCPv6 snooping client, server and relay packets.

COMMAND MODE
Privileged Exec

EXAMPLE

```

Console#show ipv6 dhcp snooping statistics
DHCPv6 Snooping Statistics:
  Client Packet: Solicit, Request, Confirm, Renew, Rebind,
                 Decline, Release, Information-request
  Server Packet: Advertise, Reply, Reconfigure
  Relay Packet:  Relay-forward, Relay-reply
State   Client   Server   Relay   Total
-----
Received 10       9        0       19
Sent     9         9        0       18
Dropped  1         0        0        1
Console#
    
```

IPv4 SOURCE GUARD

IP Source Guard is a security feature that filters IPv4 traffic on network interfaces based on manually configured entries in the IPv4 Source Guard table, or dynamic entries in the DHCPv4 Snooping table when enabled (see "DHCPv4 Snooping" on page 915). IPv4 source guard can be used to prevent traffic attacks caused when a host tries to use the IPv4 address of a neighbor to access the network. This section describes commands used to configure IPv4 Source Guard.

Table 100: IPv4 Source Guard Commands

Command	Function	Mode
<code>ip source-guard binding</code>	Adds a static address to the source-guard binding table	GC
<code>ip source-guard</code>	Configures the switch to filter inbound traffic based on source IP address, or source IP address and corresponding MAC address	IC
<code>ip source-guard max-binding</code>	Sets the maximum number of entries that can be bound to an interface	IC
<code>ip source-guard mode</code>	Sets the source-guard learning mode to search for addresses in the ACL binding table or the MAC address binding table	IC
<code>clear ip source-guard binding blocked</code>	Remove all blocked records	IC
<code>show ip source-guard</code>	Shows whether source guard is enabled or disabled on each interface	PE
<code>show ip source-guard binding</code>	Shows the source guard binding table	PE, NE

ip source-guard binding This command adds a static address to the source-guard ACL or MAC address binding table. Use the **no** form to remove a static entry.

SYNTAX

ip source-guard binding [**mode** {**acl** | **mac**}] *mac-address*
vlan *vlan-id* *ip-address* **interface ethernet** *unit/port*

no ip source-guard binding [**mode** {**acl** | **mac**}] *mac-address*
vlan *vlan-id*

mode - Specifies the binding mode.

acl - Adds binding to ACL table.

mac - Adds binding to MAC address

mac-address - A valid unicast MAC address.

vlan-id - ID of a configured VLAN (Range: 1-4094)

ip-address - A valid unicast IP address, including classful types A, B or C.

unit - Unit identifier. (Range: 1)

port - Port number. (Range: 1-28/52)

DEFAULT SETTING

No configured entries

COMMAND MODE

Global Configuration

COMMAND USAGE

- ◆ If the binding mode is not specified in this command, the entry is bound to the ACL table by default.
- ◆ Table entries include a MAC address, IP address, lease time, entry type (Static-IP-SG-Binding, Dynamic-DHCP-Binding), VLAN identifier, and port identifier.
- ◆ All static entries are configured with an infinite lease time, which is indicated with a value of zero by the [show ip source-guard](#) command (page 941).
- ◆ When source guard is enabled, traffic is filtered based upon dynamic entries learned via DHCP snooping, or static addresses configured in the source guard binding table with this command.
- ◆ Static bindings are processed as follows:
 - If there is no entry with same VLAN ID and MAC address, a new entry is added to binding table using the type of static IP source guard binding.
 - If there is an entry with same VLAN ID and MAC address, and the type of entry is static IP source guard binding, then the new entry will replace the old one.
 - If there is an entry with same VLAN ID and MAC address, and the type of the entry is dynamic DHCP snooping binding, then the new entry will replace the old one and the entry type will be changed to static IP source guard binding.

EXAMPLE

This example configures a static source-guard binding on port 5. Since the binding mode is not specified, the entry is bound to the ACL table by default.

```
Console(config)#ip source-guard binding 11-22-33-44-55-66 vlan 1 192.168.0.99
interface ethernet 1/5
Console(config-if)#
```

RELATED COMMANDS

[ip source-guard \(938\)](#)
[ip dhcp snooping \(916\)](#)
[ip dhcp snooping vlan \(921\)](#)

ip source-guard This command configures the switch to filter inbound traffic based on source IP address, or source IP address and corresponding MAC address. Use the **no** form to disable this function.

SYNTAX

ip source-guard {sip | sip-mac}

no ip source-guard

sip - Filters traffic based on IP addresses stored in the binding table.

sip-mac - Filters traffic based on IP addresses and corresponding MAC addresses stored in the binding table.

DEFAULT SETTING

Disabled

COMMAND MODE

Interface Configuration (Ethernet)

COMMAND USAGE

- ◆ Source guard is used to filter traffic on an insecure port which receives messages from outside the network or fire wall, and therefore may be subject to traffic attacks caused by a host trying to use the IP address of a neighbor.
- ◆ Setting source guard mode to "sip" or "sip-mac" enables this function on the selected port. Use the "sip" option to check the VLAN ID, source IP address, and port number against all entries in the binding table. Use the "sip-mac" option to check these same parameters, plus the source MAC address. Use the **no ip source guard** command to disable this function on the selected port.
- ◆ When enabled, traffic is filtered based upon dynamic entries learned via DHCP snooping, or static addresses configured in the source guard binding table.
- ◆ Table entries include a MAC address, IP address, lease time, entry type (Static-IP-SG-Binding, Dynamic-DHCP-Binding, VLAN identifier, and port identifier).
- ◆ Static addresses entered in the source guard binding table with the [ip source-guard binding](#) command are automatically configured with an infinite lease time. Dynamic entries learned via DHCP snooping are configured by the DHCP server itself.
- ◆ If the IP source guard is enabled, an inbound packet's IP address (sip option) or both its IP address and corresponding MAC address (sip-mac option) will be checked against the binding table. If no matching entry is found, the packet will be dropped.

- ◆ Filtering rules are implemented as follows:
 - If DHCPv4 snooping is disabled (see [page 916](#)), IP source guard will check the VLAN ID, source IP address, port number, and source MAC address (for the sip-mac option). If a matching entry is found in the binding table and the entry type is static IP source guard binding, the packet will be forwarded.
 - If the DHCP snooping is enabled, IP source guard will check the VLAN ID, source IP address, port number, and source MAC address (for the sip-mac option). If a matching entry is found in the binding table and the entry type is static IP source guard binding, or dynamic DHCP snooping binding, the packet will be forwarded.
 - If IP source guard is enabled on an interface for which IP source bindings (dynamically learned via DHCP snooping or manually configured) are not yet configured, the switch will drop all IP traffic on that port, except for DHCP packets.
 - Only unicast addresses are accepted for static bindings.

EXAMPLE

This example enables IP source guard on port 5.

```
Console(config)#interface ethernet 1/5
Console(config-if)#ip source-guard sip
Console(config-if)#
```

RELATED COMMANDS

[ip source-guard binding \(936\)](#)

[ip dhcp snooping \(916\)](#)

[ip dhcp snooping vlan \(921\)](#)

**ip source-guard
max-binding**

This command sets the maximum number of entries that can be bound to an interface. Use the **no** form to restore the default setting.

SYNTAX

ip source-guard [mode {acl | mac}] max-binding *number*

no ip source-guard [mode {acl | mac}] max-binding

mode - Specifies the learning mode.

acl - Searches for addresses in the ACL table.

mac - Searches for addresses in the MAC address table.

number - The maximum number of IP addresses that can be mapped to an interface in the binding table. (Range: 1-5 for ACL mode; 1-1024 for MAC mode)

DEFAULT SETTING

5

COMMAND MODE

Interface Configuration (Ethernet)

COMMAND USAGE

- ◆ This command sets the maximum number of address entries that can be mapped to an interface in the binding table, including both dynamic entries discovered by DHCP snooping and static entries set by the `ip source-guard` command.

EXAMPLE

This example sets the maximum number of allowed entries in the binding table for port 5 to one entry. The mode is not specified, and therefore defaults to the ACL binding table.

```
Console(config)#interface ethernet 1/5
Console(config-if)#ip source-guard max-binding 1
Console(config-if)#
```

ip source-guard mode

This command sets the source-guard learning mode to search for addresses in the ACL binding table or the MAC address binding table. Use the **no** form to restore the default setting.

SYNTAX

ip source-guard mode {acl | mac}

no ip source-guard mode

mode - Specifies the learning mode.

acl - Searches for addresses in the ACL table.

mac - Searches for addresses in the MAC address table.

DEFAULT SETTING

ACL

COMMAND MODE

Interface Configuration (Ethernet)

EXAMPLE

This command sets the binding table mode for the specified interface to MAC mode:

```
Console(config)#interface ethernet 1/5
Console(config-if)#ip source-guard mode mac
Console(config-if)#
```

clear ip source-guard binding blocked This command remove all blocked records.
SYNTAX

clear ip source-guard binding blocked

COMMAND MODE

Privileged Exec

COMMAND USAGE

When IP Source-Guard detects an invalid packet it creates a blocked record. These records can be viewed using the [show ip source-guard binding blocked](#) command. A maximum of 512 blocked records can be stored before the switch overwrites the oldest record with new blocked records. Use the **clear ip source-guard binding blocked** command to clear this table.

EXAMPLE

This command clears the blocked record table.

```
Console(config)#clear ip source-guard binding blocked
Console(config)#
```

show ip source-guard This command shows whether source guard is enabled or disabled on each interface.

COMMAND MODE

Privileged Exec

EXAMPLE

```
Console#show ip source-guard
```

Interface	Filter-type	Filter-table	ACL Table	MAC Table
			Max-binding	Max-binding
Eth 1/1	DISABLED	ACL	5	1024
Eth 1/2	DISABLED	ACL	5	1024
Eth 1/3	DISABLED	ACL	5	1024
Eth 1/4	DISABLED	ACL	5	1024
Eth 1/5	DISABLED	ACL	5	1024
:				

show ip source-guard binding This command shows the source guard binding table.
SYNTAX

show ip source-guard binding [**dhcp-snooping** | **static** [**acl** | **mac**] | **blocked** [**vlan** *vlan-id* | **interface** *interface*]

dhcp-snooping - Shows dynamic entries configured with DHCP Snooping commands (see [page 915](#))

static - Shows static entries configured with the **ip source-guard binding** command (see [page 936](#)).

acl - Shows static entries in the ACL binding table.

mac - Shows static entries in the MAC address binding table.

blocked - Shows blocked records of invalid packets.

vlan-id (Range: 1-4094)

interface

ethernet *unit/port*

unit - Unit identifier. (Range: 1)

port - Port number. (Range: 1-28/52)

COMMAND MODE

Normal Exec

EXAMPLE

```
Console#show ip source-guard binding
MAC Address      IP Address      Lease(sec)  Type           VLAN  Interface
-----
11-22-33-44-55-66 192.168.0.99    0           Static         1     Eth 1/5
Console#
```

IPv6 SOURCE GUARD

IPv6 Source Guard is a security feature that filters IPv6 traffic on non-routed, Layer 2 network interfaces based on manually configured entries in the IPv6 Source Guard table, or dynamic entries in the Neighbor Discovery Snooping table or DHCPv6 Snooping table when either snooping protocol is enabled (see "DHCPv6 Snooping" on page 926). IPv6 source guard can be used to prevent traffic attacks caused when a host tries to use the IPv6 address of a neighbor to access the network. This section describes commands used to configure IPv6 Source Guard.

Table 101: IPv6 Source Guard Commands

Command	Function	Mode
<code>ipv6 source-guard binding</code>	Adds a static address to the source-guard binding table	GC
<code>ipv6 source-guard</code>	Configures the switch to filter inbound traffic based on source IP address	IC
<code>ipv6 source-guard max-binding</code>	Sets the maximum number of entries that can be bound to an interface	IC
<code>show ipv6 source-guard</code>	Shows whether source guard is enabled or disabled on each interface	PE
<code>show ipv6 source-guard binding</code>	Shows the source guard binding table	PE

ipv6 source-guard binding This command adds a static address to the source-guard binding table. Use the **no** form to remove a static entry.

SYNTAX

ipv6 source-guard binding *mac-address* **vlan** *vlan-id* *ipv6-address*
interface *interface*

no ipv6 source-guard binding *mac-address* **vlan** *vlan-id*

mac-address - A valid unicast MAC address.

vlan-id - ID of a configured VLAN (Range: 1-4094)

ipv6-address - Corresponding IPv6 address. This address must be entered according to RFC 2373 "IPv6 Addressing Architecture," using 8 colon-separated 16-bit hexadecimal values. One double colon may be used in the address to indicate the appropriate number of zeros required to fill the undefined fields.

interface

ethernet *unit/port*

unit - Unit identifier. (Range: 1)

port - Port number. (Range: 1-28/52)

DEFAULT SETTING

No configured entries

COMMAND MODE

Global Configuration

COMMAND USAGE

- ◆ Table entries include an associated MAC address, IPv6 global unicast address, entry type (Static-IPv6-SG-Binding, Dynamic-ND-Snooping, Dynamic-DHCPv6-Snooping), VLAN identifier, and port identifier.
- ◆ Traffic filtering is based only on the source IPv6 address, VLAN ID, and port number.
- ◆ All static entries are configured with an infinite lease time, which is indicated with a value of zero by the `show ipv6 source-guard` command.
- ◆ When source guard is enabled, traffic is filtered based upon dynamic entries learned via ND snooping, DHCPv6 snooping, or static addresses configured in the source guard binding table with this command.
- ◆ Static bindings are processed as follows:
 - If there is no entry with same and MAC address and IPv6 address, a new entry is added to binding table using static IPv6 source guard binding.
 - If there is an entry with same MAC address and IPv6 address, and the type of entry is static IPv6 source guard binding, then the new entry will replace the old one.
 - If there is an entry with same MAC address and IPv6 address, and the type of the entry is either a dynamic ND snooping binding or DHCPv6 snooping binding, then the new entry will replace the old one and the entry type will be changed to static IPv6 source guard binding.
 - Only unicast addresses are accepted for static bindings.

EXAMPLE

This example configures a static source-guard binding on port 5.

```
Console(config)#ipv6 source-guard binding 00-ab-11-cd-23-45 vlan 1 2001::1
interface ethernet 1/5
Console(config)#
```

RELATED COMMANDS

[ipv6 source-guard \(945\)](#)
[ipv6 dhcp snooping \(927\)](#)
[ipv6 dhcp snooping vlan \(931\)](#)

ipv6 source-guard This command configures the switch to filter inbound traffic based on the source IP address stored in the binding table. Use the **no** form to disable this function.

SYNTAX

ipv6 source-guard sip
no ipv6 source-guard

DEFAULT SETTING

Disabled

COMMAND MODE

Interface Configuration (Ethernet)

COMMAND USAGE

- ◆ Source guard is used to filter traffic on an insecure port which receives messages from outside the network or fire wall, and therefore may be subject to traffic attacks caused by a host trying to use the IP address of a neighbor.
- ◆ This command checks the VLAN ID, IPv6 global unicast source IP address, and port number against all entries in the binding table. Use the **no ipv6 source guard** command to disable this function on the selected port.
- ◆ After IPv6 source guard is enabled on an interface, the switch initially blocks all IPv6 traffic received on that interface, except for ND packets allowed by ND snooping and DHCPv6 packets allowed by DHCPv6 snooping. A port access control list (ACL) is applied to the interface. Traffic is then filtered based upon dynamic entries learned via ND snooping or DHCPv6 snooping, or static addresses configured in the source guard binding table. The port allows only IPv6 traffic with a matching entry in the binding table and denies all other IPv6 traffic.
- ◆ Table entries include a MAC address, IPv6 global unicast address, entry type (Static-IPv6-SG-Binding, Dynamic-ND-Binding, Dynamic-DHCPv6-Binding), VLAN identifier, and port identifier.
- ◆ Static addresses entered in the source guard binding table with the [ipv6 source-guard binding](#) command are automatically configured with an infinite lease time. Dynamic entries learned via DHCPv6 snooping are configured by the DHCPv6 server itself.
- ◆ If IPv6 source guard is enabled, an inbound packet's source IPv6 address will be checked against the binding table. If no matching entry is found, the packet will be dropped.
- ◆ Filtering rules are implemented as follows:
 - If ND snooping and DHCPv6 snooping are disabled, IPv6 source guard will check the VLAN ID, source IPv6 address, and port number. If a matching entry is found in the binding table and the

entry type is static IPv6 source guard binding, the packet will be forwarded.

- If ND snooping or DHCPv6 snooping is enabled, IPv6 source guard will check the VLAN ID, source IP address, and port number. If a matching entry is found in the binding table and the entry type is static IPv6 source guard binding, dynamic ND snooping binding, or dynamic DHCPv6 snooping binding, the packet will be forwarded.
- If IPv6 source guard is enabled on an interface for which IPv6 source bindings (dynamically learned via ND snooping or DHCPv6 snooping, or manually configured) are not yet configured, the switch will drop all IPv6 traffic on that port, except for ND packets and DHCPv6 packets.
- Only IPv6 global unicast addresses are accepted for static bindings.

EXAMPLE

This example enables IP source guard on port 5.

```
Console(config)#interface ethernet 1/5
Console(config-if)#ipv6 source-guard sip
Console(config-if)#
```

RELATED COMMANDS

[ipv6 source-guard binding \(943\)](#)
[ipv6 dhcp snooping \(927\)](#)
[ipv6 dhcp snooping vlan \(931\)](#)

ipv6 source-guard max-binding This command sets the maximum number of entries that can be bound to an interface. Use the **no** form to restore the default setting.

SYNTAX

ipv6 source-guard max-binding *number*

no ipv6 source-guard max-binding

number - The maximum number of IPv6 addresses that can be mapped to an interface in the binding table. (Range: 1-5)

DEFAULT SETTING

5

COMMAND MODE

Interface Configuration (Ethernet)

COMMAND USAGE

- ◆ This command sets the maximum number of address entries that can be mapped to an interface in the binding table, including both dynamic entries discovered by ND snooping, DHCPv6 snooping, and static entries set by the [ipv6 source-guard](#) command.

- ◆ IPv6 source guard maximum bindings must be set to a value higher than DHCPv6 snooping maximum bindings and ND snooping maximum bindings.
- ◆ If IPv6 source guard, ND snooping, and DHCPv6 snooping are enabled on a port, the dynamic bindings used by ND snooping, DHCPv6 snooping, and IPv6 source guard static bindings cannot exceed the maximum allowed bindings set by the **ipv6 source-guard max-binding** command. In other words, no new entries will be added to the IPv6 source guard binding table.
- ◆ If IPv6 source guard is enabled on a port, and the maximum number of allowed bindings is changed to a lower value, precedence is given to deleting entries learned through DHCPv6 snooping, ND snooping, and then manually configured IPv6 source guard static bindings, until the number of entries in the binding table reaches the newly configured maximum number of allowed bindings.

EXAMPLE

This example sets the maximum number of allowed entries in the binding table for port 5 to one entry.

```
Console(config)#interface ethernet 1/5
Console(config-if)#ipv6 source-guard max-binding 1
Console(config-if)#
```

show ipv6 source-guard This command shows whether IPv6 source guard is enabled or disabled on each interface, and the maximum allowed bindings.

COMMAND MODE

Privileged Exec

EXAMPLE

```
Console#show ipv6 source-guard
Interface  Filter-type  Max-binding
-----  -
Eth 1/1    DISABLED      5
Eth 1/2    DISABLED      5
Eth 1/3    DISABLED      5
Eth 1/4    DISABLED      5
Eth 1/5    SIP           1
Eth 1/6    DISABLED      5
:
```

show ipv6 source-guard binding This command shows the IPv6 source guard binding table.
SYNTAX

show ipv6 source-guard binding [dynamic | static]

dynamic - Shows dynamic entries configured with ND Snooping or DHCPv6 Snooping commands (see [page 926](#))

static - Shows static entries configured with the [ipv6 source-guard binding](#) command.

COMMAND MODE
Privileged Exec

EXAMPLE

```

Console#show ipv6 source-guard binding
MAC Address      IPv6 Address      VLAN Interface Type
-----
00AB-11CD-2345   2001::1          1 Eth 1/5 STA
Console#
    
```

ARP INSPECTION

ARP Inspection validates the MAC-to-IP address bindings in Address Resolution Protocol (ARP) packets. It protects against ARP traffic with invalid address bindings, which forms the basis for certain “man-in-the-middle” attacks. This is accomplished by intercepting all ARP requests and responses and verifying each of these packets before the local ARP cache is updated or the packet is forwarded to the appropriate destination, dropping any invalid ARP packets.

ARP Inspection determines the validity of an ARP packet based on valid IP-to-MAC address bindings stored in a trusted database – the DHCP snooping binding database. ARP Inspection can also validate ARP packets against user-configured ARP access control lists (ACLs) for hosts with statically configured IP addresses.

This section describes commands used to configure ARP Inspection.

Table 102: ARP Inspection Commands

Command	Function	Mode
ip arp inspection	Enables ARP Inspection globally on the switch	GC
ip arp inspection filter	Specifies an ARP ACL to apply to one or more VLANs	GC
ip arp inspection log-buffer logs	Sets the maximum number of entries saved in a log message, and the rate at these messages are sent	GC
ip arp inspection validate	Specifies additional validation of address components in an ARP packet	GC
ip arp inspection vlan	Enables ARP Inspection for a specified VLAN or range of VLANs	GC

Table 102: ARP Inspection Commands (Continued)

Command	Function	Mode
<code>ip arp inspection limit</code>	Sets a rate limit for the ARP packets received on a port	IC
<code>ip arp inspection trust</code>	Sets a port as trusted, and thus exempted from ARP Inspection	IC
<code>show ip arp inspection configuration</code>	Displays the global configuration settings for ARP Inspection	PE
<code>show ip arp inspection interface</code>	Shows the trust status and inspection rate limit for ports	PE
<code>show ip arp inspection log</code>	Shows information about entries stored in the log, including the associated VLAN, port, and address components	PE
<code>show ip arp inspection statistics</code>	Shows statistics about the number of ARP packets processed, or dropped for various reasons	PE
<code>show ip arp inspection vlan</code>	Shows configuration setting for VLANs, including ARP Inspection status, the ARP ACL name, and if the DHCP Snooping database is used after ACL validation is completed	PE

ip arp inspection This command enables ARP Inspection globally on the switch. Use the **no** form to disable this function.

SYNTAX

[no] ip arp inspection

DEFAULT SETTING

Disabled

COMMAND MODE

Global Configuration

COMMAND USAGE

- ◆ When ARP Inspection is enabled globally with this command, it becomes active only on those VLANs where it has been enabled with the `ip arp inspection vlan` command.
- ◆ When ARP Inspection is enabled globally and enabled on selected VLANs, all ARP request and reply packets on those VLANs are redirected to the CPU and their switching is handled by the ARP Inspection engine.
- ◆ When ARP Inspection is disabled globally, it becomes inactive for all VLANs, including those where ARP Inspection is enabled.
- ◆ When ARP Inspection is disabled, all ARP request and reply packets bypass the ARP Inspection engine and their manner of switching matches that of all other packets.
- ◆ Disabling and then re-enabling global ARP Inspection will not affect the ARP Inspection configuration for any VLANs.

- ◆ When ARP Inspection is disabled globally, it is still possible to configure ARP Inspection for individual VLANs. These configuration changes will only become active after ARP Inspection is globally enabled again.

EXAMPLE

```
Console(config)#ip arp inspection
Console(config)#
```

ip arp inspection filter

This command specifies an ARP ACL to apply to one or more VLANs. Use the **no** form to remove an ACL binding. Use the **no** form to remove an ACL binding.

SYNTAX

ip arp inspection filter *arp-acl-name* **vlan** {*vlan-id* | *vlan-range*}
[**static**]

no ip arp inspection filter *arp-acl-name* **vlan** {*vlan-id* | *vlan-range*}

arp-acl-name - Name of an ARP ACL.
(Maximum length: 16 characters)

vlan-id - VLAN ID. (Range: 1-4094)

vlan-range - A consecutive range of VLANs indicated by the use a hyphen, or a random group of VLANs with each entry separated by a comma.

static - ARP packets are only validated against the specified ACL, address bindings in the DHCP snooping database is not checked.

DEFAULT SETTING

ARP ACLs are not bound to any VLAN
Static mode is not enabled

COMMAND MODE

Global Configuration

COMMAND USAGE

- ◆ ARP ACLs are configured with the commands described on [page 369](#).
- ◆ If static mode is enabled, the switch compares ARP packets to the specified ARP ACLs. Packets matching an IP-to-MAC address binding in a permit or deny rule are processed accordingly. Packets not matching any of the ACL rules are dropped. Address bindings in the DHCP snooping database are not checked.
- ◆ If static mode is not enabled, packets are first validated against the specified ARP ACL. Packets matching a deny rule are dropped. All remaining packets are validated against the address bindings in the DHCP snooping database.

EXAMPLE

```
Console(config)#ip arp inspection filter sales vlan 1
Console(config)#
```

**ip arp inspection
log-buffer logs**

This command sets the maximum number of entries saved in a log message, and the rate at which these messages are sent. Use the **no** form to restore the default settings.

SYNTAX

ip arp inspection log-buffer logs *message-number* **interval** *seconds*

no ip arp inspection log-buffer logs

message-number - The maximum number of entries saved in a log message. (Range: 0-256, where 0 means no events are saved and no messages sent)

seconds - The interval at which log messages are sent. (Range: 0-86400)

DEFAULT SETTING

Message Number: 5

Interval: 1 second

COMMAND MODE

Global Configuration

COMMAND USAGE

- ◆ ARP Inspection must be enabled with the [ip arp inspection](#) command before this command will be accepted by the switch.
- ◆ By default, logging is active for ARP Inspection, and cannot be disabled.
- ◆ When the switch drops a packet, it places an entry in the log buffer. Each entry contains flow information, such as the receiving VLAN, the port number, the source and destination IP addresses, and the source and destination MAC addresses.
- ◆ If multiple, identical invalid ARP packets are received consecutively on the same VLAN, then the logging facility will only generate one entry in the log buffer and one corresponding system message.
- ◆ The maximum number of entries that can be stored in the log buffer is determined by the *message-number* parameter. If the log buffer fills up before a message is sent, the oldest entry will be replaced with the newest one.
- ◆ The switch generates a system message on a rate-controlled basis determined by the *seconds* values. After the system message is generated, all entries are cleared from the log buffer.

EXAMPLE

```
Console(config)#ip arp inspection log-buffer logs 1 interval 10  
Console(config)#
```

ip arp inspection validate This command specifies additional validation of address components in an ARP packet. Use the **no** form to restore the default setting.

SYNTAX

ip arp inspection validate

```
{dst-mac [ip [allow-zeros] [src-mac]] |  
ip [allow-zeros] [src-mac]] | src-mac}
```

no ip arp inspection validate

dst-mac - Checks the destination MAC address in the Ethernet header against the target MAC address in the ARP body. This check is performed for ARP responses. When enabled, packets with different MAC addresses are classified as invalid and are dropped.

ip - Checks the ARP body for invalid and unexpected IP addresses. Addresses include 0.0.0.0, 255.255.255.255, and all IP multicast addresses. Sender IP addresses are checked in all ARP requests and responses, while target IP addresses are checked only in ARP responses.

allow-zeros - Allows sender IP address to be 0.0.0.0.

src-mac - Checks the source MAC address in the Ethernet header against the sender MAC address in the ARP body. This check is performed on both ARP requests and responses. When enabled, packets with different MAC addresses are classified as invalid and are dropped.

DEFAULT SETTING

No additional validation is performed

COMMAND MODE

Global Configuration

COMMAND USAGE

By default, ARP Inspection only checks the IP-to-MAC address bindings specified in an ARP ACL or in the DHCP Snooping database.

EXAMPLE

```
Console(config)#ip arp inspection validate dst-mac  
Console(config)#
```

ip arp inspection vlan This command enables ARP Inspection for a specified VLAN or range of VLANs. Use the **no** form to disable this function.

SYNTAX

[no] ip arp inspection vlan {*vlan-id* | *vlan-range*}

vlan-id - VLAN ID. (Range: 1-4094)

vlan-range - A consecutive range of VLANs indicated by the use a hyphen, or a random group of VLANs with each entry separated by a comma.

DEFAULT SETTING

Disabled on all VLANs

COMMAND MODE

Global Configuration

COMMAND USAGE

- ◆ When ARP Inspection is enabled globally with the **ip arp inspection** command, it becomes active only on those VLANs where it has been enabled with this command.
- ◆ When ARP Inspection is enabled globally and enabled on selected VLANs, all ARP request and reply packets on those VLANs are redirected to the CPU and their switching is handled by the ARP Inspection engine.
- ◆ When ARP Inspection is disabled globally, it becomes inactive for all VLANs, including those where ARP Inspection is enabled.
- ◆ When ARP Inspection is disabled, all ARP request and reply packets bypass the ARP Inspection engine and their manner of switching matches that of all other packets.
- ◆ Disabling and then re-enabling global ARP Inspection will not affect the ARP Inspection configuration for any VLANs.
- ◆ When ARP Inspection is disabled globally, it is still possible to configure ARP Inspection for individual VLANs. These configuration changes will only become active after ARP Inspection is globally enabled again.

EXAMPLE

```
Console(config)#ip arp inspection vlan 1,2
Console(config)#
```

ip arp inspection limit This command sets a rate limit for the ARP packets received on a port. Use the **no** form to restore the default setting.

SYNTAX

ip arp inspection limit {rate *pps* | **none**}

no ip arp inspection limit

pps - The maximum number of ARP packets that can be processed by the CPU per second on trusted or untrusted ports.
(Range: 0-2048, where 0 means that no ARP packets can be forwarded)

none - There is no limit on the number of ARP packets that can be processed by the CPU.

DEFAULT SETTING

15

COMMAND MODE

Interface Configuration (Port, Static Aggregation)

COMMAND USAGE

- ◆ This command applies to both trusted and untrusted ports.
- ◆ When the rate of incoming ARP packets exceeds the configured limit, the switch drops all ARP packets in excess of the limit.

EXAMPLE

```
Console(config)#interface ethernet 1/1
Console(config-if)#ip arp inspection limit rate 150
Console(config-if)#
```

ip arp inspection trust This command sets a port as trusted, and thus exempted from ARP Inspection. Use the **no** form to restore the default setting.

SYNTAX

[**no**] **ip arp inspection trust**

DEFAULT SETTING

Untrusted

COMMAND MODE

Interface Configuration (Port, Static Aggregation)

COMMAND USAGE

Packets arriving on untrusted ports are subject to any configured ARP Inspection and additional validation checks. Packets arriving on trusted ports bypass all of these checks, and are forwarded according to normal switching rules.

EXAMPLE

```

Console(config)#interface ethernet 1/1
Console(config-if)#ip arp inspection trust
Console(config-if)#

```

**show ip
arp inspection
configuration**

This command displays the global configuration settings for ARP Inspection.

COMMAND MODE
Privileged Exec

EXAMPLE

```

Console#show ip arp inspection configuration

ARP inspection global information:

Global IP ARP Inspection status : disabled
Log Message Interval           : 10 s
Log Message Number             : 1
Need Additional Validation(s)  : Yes
Additional Validation Type      : Destination MAC address
Console#

```

**show ip
arp inspection
interface**

This command shows the trust status and ARP Inspection rate limit for ports.

SYNTAX

```

show ip arp inspection interface [interface]
interface
    ethernet unit/port
    unit - Unit identifier. (Range: 1)
    port - Port number. (Range: 1-28/52)

```

COMMAND MODE
Privileged Exec

EXAMPLE

```

Console#show ip arp inspection interface ethernet 1/1

Port Number      Trust Status      Rate Limit (pps)
-----
Eth 1/1          Trusted           150
Console#

```

show ip arp inspection log This command shows information about entries stored in the log, including the associated VLAN, port, and address components.

COMMAND MODE
Privileged Exec

EXAMPLE

```
Console#show ip arp inspection log
Total log entries number is 1

Num VLAN Port Src IP Address Dst IP Address Src MAC Address Dst MAC Address
-----
1 1 11 192.168.2.2 192.168.2.1 00-04-E2-A0-E2-7C FF-FF-FF-FF-FF-FF
Console#
```

show ip arp inspection statistics This command shows statistics about the number of ARP packets processed, or dropped for various reasons.

COMMAND MODE
Privileged Exec

EXAMPLE

```
Console#show ip arp inspection statistics

ARP packets received before rate limit : 150
ARP packets dropped due to rate limit : 5
Total ARP packets processed by ARP Inspection : 150
ARP packets dropped by additional validation (source MAC address) : 0
ARP packets dropped by additional validation (destination MAC address): 0
ARP packets dropped by additional validation (IP address) : 0
ARP packets dropped by ARP ACLs : 0
ARP packets dropped by DHCP snooping : 0

Console#
```

show ip arp inspection vlan This command shows the configuration settings for VLANs, including ARP Inspection status, the ARP ACL name, and if the DHCP Snooping database is used after ARP ACL validation is completed.

SYNTAX

show ip arp inspection vlan [*vlan-id* | *vlan-range*]

vlan-id - VLAN ID. (Range: 1-4094)

vlan-range - A consecutive range of VLANs indicated by the use a hyphen, or a random group of VLANs with each entry separated by a comma.

COMMAND MODE
Privileged Exec

EXAMPLE

```

Console#show ip arp inspection vlan 1

VLAN ID      DAI Status      ACL Name      ACL Status
-----      -
1            disabled        sales         static
Console#

```

DENIAL OF SERVICE PROTECTION

A denial-of-service attack (DoS attack) is an attempt to block the services provided by a computer or network resource. This kind of attack tries to prevent an Internet site or service from functioning efficiently or at all. In general, DoS attacks are implemented by either forcing the target to reset, to consume most of its resources so that it can no longer provide its intended service, or to obstruct the communication media between the intended users and the target so that they can no longer communicate adequately.

This section describes commands used to protect against DoS attacks.

Table 103: DoS Protection Commands

Command	Function	Mode
<code>dos-protection echo-charge</code>	Protects against DoS echo/charge attacks	GC
<code>dos-protection smurf</code>	Protects against DoS smurf attacks	GC
<code>dos-protection tcp-flooding</code>	Protects against DoS TCP-flooding attacks	GC
<code>dos-protection tcp-null-scan</code>	Protects against DoS TCP-null-scan attacks	GC
<code>dos-protection tcp-syn-fin-scan</code>	Protects against DoS TCP-SYN/FIN-scan attacks	GC
<code>dos-protection tcp-udp-port-zero</code>	Protects against attacks which set the Layer 4 source or destination port to zero	GC
<code>dos-protection tcp-xmas-scan</code>	Protects against DoS TCP-XMAS-scan attacks	GC
<code>dos-protection udp-flooding</code>	Protects against DoS UDP-flooding attacks	GC
<code>dos-protection win-nuke</code>	Protects against DoS WinNuke attacks	GC
<code>show dos-protection</code>	Shows the configuration settings for DoS protection	PE

dos-protection echo-charge This command protects against DoS echo/charge attacks in which the echo service repeats anything sent to it, and the charge (character generator) service generates a continuous stream of data. When used together, they create an infinite loop and result in a denial-of-service. Use the **no** form to disable this feature.

SYNTAX

dos-protection echo-charge [**bit-rate-in-kilo** *rate*]

no dos-protection echo-charge

rate – Maximum allowed rate. (Range: 64-2000 kbits/second)

DEFAULT SETTING

Disabled, 1000 kbits/second

COMMAND MODE

Global Configuration

EXAMPLE

```
Console(config)#dos-protection echo-charge 65  
Console(config)#
```

dos-protection smurf This command protects against DoS smurf attacks in which a perpetrator generates a large amount of spoofed ICMP Echo Request traffic to the broadcast destination IP address (255.255.255.255), all of which uses a spoofed source address of the intended victim. The victim should crash due to the many interrupts required to send ICMP Echo response packets. Use the **no** form to disable this feature.

SYNTAX

[**no**] **dos-protection smurf**

DEFAULT SETTING

Enabled

COMMAND MODE

Global Configuration

EXAMPLE

```
Console(config)#dos-protection smurf  
Console(config)#
```

dos-protection tcp-flooding This command protects against DoS TCP-flooding attacks in which a perpetrator sends a succession of TCP SYN requests (with or without a spoofed-Source IP) to a target and never returns ACK packets. These half-open connections will bind resources on the target, and no new connections can be made, resulting in a denial of service. Use the **no** form to disable this feature.

SYNTAX

dos-protection tcp-flooding [**bit-rate-in-kilo** *rate*]

no dos-protection tcp-flooding

rate – Maximum allowed rate. (Range: 64-2000 kbits/second)

DEFAULT SETTING

Disabled, 1000 kbits/second

COMMAND MODE

Global Configuration

EXAMPLE

```
Console(config)#dos-protection tcp-flooding 65
Console(config)#
```

dos-protection tcp-null-scan This command protects against DoS TCP-null-scan attacks in which a TCP NULL scan message is used to identify listening TCP ports. The scan uses a series of strangely configured TCP packets which contain a sequence number of 0 and no flags. If the target's TCP port is closed, the target replies with a TCP RST (reset) packet. If the target TCP port is open, it simply discards the TCP NULL scan. Use the **no** form to disable this feature.

SYNTAX

[**no**] **dos-protection tcp-null-scan**

DEFAULT SETTING

Enabled

COMMAND MODE

Global Configuration

EXAMPLE

```
Console(config)#dos-protection tcp-null-scan
Console(config)#
```

dos-protection tcp-syn-fin-scan

This command protects against DoS TCP-SYN/FIN-scan attacks in which a TCP SYN/FIN scan message is used to identify listening TCP ports. The scan uses a series of strangely configured TCP packets which contain SYN (synchronize) and FIN (finish) flags. If the target's TCP port is closed, the target replies with a TCP RST (reset) packet. If the target TCP port is open, it simply discards the TCP SYN FIN scan. Use the **no** form to disable this feature.

SYNTAX

[no] dos-protection syn-fin-scan

DEFAULT SETTING

Enabled

COMMAND MODE

Global Configuration

EXAMPLE

```
Console(config)#dos-protection syn-fin-scan
Console(config)#
```

dos-protection tcp-udp-port-zero

This command protects against DoS attacks in which the UDP or TCP source port or destination port is set to zero. This technique may be used as a form of DoS attack, or it may just indicate a problem with the source device. Use the **no** form to restore the default setting.

SYNTAX

dos-protection tcp-udp-port-zero {drop | forward}

no dos-protection tcp-udp-port-zero

drop – Drops all packets with the Layer 4 source port or destination port set to zero.

forward – Forwards all packets with the Layer 4 source port or destination port set to zero.

DEFAULT SETTING

Drop

COMMAND MODE

Global Configuration

EXAMPLE

```
Console(config)#dos-protection tcp-udp-port-zero forward
Console(config)#
```

dos-protection tcp-xmas-scan This command protects against DoS TCP-xmas-scan in which a so-called TCP XMAS scan message is used to identify listening TCP ports. This scan uses a series of strangely configured TCP packets which contain a sequence number of 0 and the URG, PSH and FIN flags. If the target's TCP port is closed, the target replies with a TCP RST packet. If the target TCP port is open, it simply discards the TCP XMAS scan. Use the **no** form to disable this feature.

SYNTAX

[no] dos-protection tcp-xmas-scan

DEFAULT SETTING

Enabled

COMMAND MODE

Global Configuration

EXAMPLE

```
Console(config)#dos-protection tcp-xmas-scan
Console(config)#
```

dos-protection udp-flooding This command protects against DoS UDP-flooding attacks in which a perpetrator sends a large number of UDP packets (with or without a spoofed-Source IP) to random ports on a remote host. The target will determine that application is listening at that port, and reply with an ICMP Destination Unreachable packet. It will be forced to send many ICMP packets, eventually leading it to be unreachable by other clients. Use the **no** form to disable this feature.

SYNTAX

dos-protection udp-flooding [bit-rate-in-kilo *rate*]

no dos-protection udp-flooding

rate – Maximum allowed rate. (Range: 64-2000 kbits/second)

DEFAULT SETTING

Disabled, 1000 kbits/second

COMMAND MODE

Global Configuration

EXAMPLE

```
Console(config)#dos-protection udp-flooding 65
Console(config)#
```

dos-protection win-uke This command protects against DoS WinNuke attacks in which affected the Microsoft Windows 3.1x/95/NT operating systems. In this type of attack, the perpetrator sends the string of OOB out-of-band (OOB) packets contained a TCP URG flag to the target computer on TCP port 139 (NetBIOS), causing it to lock up and display a "Blue Screen of Death." This did not cause any damage to, or change data on, the computer's hard disk, but any unsaved data would be lost. Microsoft made patches to prevent the WinNuke attack, but the OOB packets still put the service in a tight loop that consumed all available CPU time. Use the **no** form to disable this feature.

SYNTAX

dos-protection win-uke [bit-rate-in-kilo rate]

no dos-protection udp-flooding

rate – Maximum allowed rate. (Range: 64-2000 kbits/second)

DEFAULT SETTING

Disabled, 1000 kbits/second

COMMAND MODE

Global Configuration

EXAMPLE

```
Console(config)#dos-protection win-uke 65
Console(config)#
```

show dos-protection This command shows the configuration settings for the DoS protection commands.

COMMAND MODE

Privileged Exec

EXAMPLE

```
Console#show dos-protection
Global DoS Protection:

Echo/Chargen Attack           : Disabled, 1000 kilobits per second
Smurf Attack                   : Enabled
TCP Flooding Attack           : Disabled, 1000 kilobits per second
TCP Null Scan                  : Enabled
TCP SYN/FIN Scan              : Enabled
TCP/UDP Packets with Port 0   : Enabled
TCP XMAS Scan                  : Enabled
UDP Flooding Attack           : Disabled, 1000 kilobits per second
WinNuke Attack                 : Disabled, 1000 kilobits per second
Console#
```

PORT-BASED TRAFFIC SEGMENTATION

If tighter security is required for passing traffic from different clients through downlink ports on the local network and over uplink ports to the service provider, port-based traffic segmentation can be used to isolate traffic for individual clients.

Traffic belonging to each client is isolated to the allocated downlink ports. But the switch can be configured to either isolate traffic passing across a client's allocated uplink ports from the uplink ports assigned to other clients, or to forward traffic through the uplink ports used by other clients, allowing different clients to share access to their uplink ports where security is less likely to be compromised.

Table 104: Commands for Configuring Traffic Segmentation

Command	Function	Mode
<code>traffic-segmentation</code>	Enables traffic segmentation	GC
<code>traffic-segmentation session</code>	Creates a client session	GC
<code>traffic-segmentation uplink/downlink</code>	Configures uplink/downlink ports for client sessions	GC
<code>traffic-segmentation uplink-to-uplink</code>	Specifies whether or not traffic can be forwarded between uplink ports assigned to different client sessions	GC
<code>show traffic-segmentation</code>	Displays the configured traffic segments	PE

traffic-segmentation This command enables traffic segmentation. Use the **no** form to disable traffic segmentation.

SYNTAX

[no] traffic-segmentation

DEFAULT SETTING

Disabled

COMMAND MODE

Global Configuration

COMMAND USAGE

- ◆ Traffic segmentation provides port-based security and isolation between ports within the VLAN. Data traffic on the downlink ports can only be forwarded to, and from, the designated uplink port(s). Data cannot pass between downlink ports in the same segmented group, nor to ports which do not belong to the same group.
- ◆ Traffic segmentation and normal VLANs can exist simultaneously within the same switch. Traffic may pass freely between uplink ports in segmented groups and ports in normal VLANs.

- ◆ When traffic segmentation is enabled, the forwarding state for the uplink and downlink ports assigned to different client sessions is shown below.

Table 105: Traffic Segmentation Forwarding

Destination Source	Session #1 Downlinks	Session #1 Uplinks	Session #2 Downlinks	Session #2 Uplinks	Normal Ports
Session #1 Downlink Ports	Blocking	Forwarding	Blocking	Blocking	Blocking
Session #1 Uplink Ports	Forwarding	Forwarding	Blocking	Blocking/ Forwarding*	Forwarding
Session #2 Downlink Ports	Blocking	Blocking	Blocking	Forwarding	Blocking
Session #2 Uplink Ports	Blocking	Blocking/ Forwarding*	Forwarding	Forwarding	Forwarding
Normal Ports	Forwarding	Forwarding	Forwarding	Forwarding	Forwarding

* The forwarding state for uplink-to-uplink ports is configured by the `traffic-segmentation uplink-to-uplink` command.

- ◆ When traffic segmentation is disabled, all ports operate in normal forwarding mode based on the settings specified by other functions such as VLANs and spanning tree protocol.
- ◆ Enter the **traffic-segmentation** command without any parameters to enable traffic segmentation. Then set the interface members for segmented groups using the `traffic-segmentation uplink/downlink` command.
- ◆ Enter **no traffic-segmentation** to disable traffic segmentation and clear the configuration settings for segmented groups.

EXAMPLE

This example enables traffic segmentation globally on the switch.

```
Console(config)#traffic-segmentation
Console(config)#
```

traffic-segmentation session

This command creates a traffic-segmentation client session. Use the **no** form to remove a client session.

SYNTAX

[no] pvlan session session-id

session-id – Traffic segmentation session. (Range: 1-4)

DEFAULT SETTING

None

COMMAND MODE

Global Configuration

Command Usage

- ◆ Use this command to create a new traffic-segmentation client session.
- ◆ Using the **no** form of this command will remove any assigned uplink or downlink ports, restoring these interfaces to normal operating mode.

Example

```
Console(config)#traffic-segmentation session 1
Console(config)#
```

traffic-segmentation uplink/downlink

This command configures the uplink and down-link ports for a segmented group of ports. Use the **no** form to remove a port from the segmented group.

SYNTAX

[no] traffic-segmentation [**session** *session-id*] {**uplink** *interface-list* [**downlink** *interface-list*] | **downlink** *interface-list*}

session-id – Traffic segmentation session. (Range: 1-4)

uplink – Specifies an uplink interface.

downlink – Specifies a downlink interface.

interface

ethernet *unit/port*

unit - Unit identifier. (Range: 1)

port - Port number. (Range: 1-28/52)

port-channel *channel-id* (Range: 1-16)

DEFAULT SETTING

Session 1 if not defined

No segmented port groups are defined.

COMMAND MODE

Global Configuration

COMMAND USAGE

- ◆ A port cannot be configured in both an uplink and downlink list.
- ◆ A port can only be assigned to one traffic-segmentation session.
- ◆ When specifying an uplink or downlink, a list of ports may be entered by using a hyphen or comma in the *port* field. Note that lists are not supported for the *channel-id* field.

- ◆ A downlink port can only communicate with an uplink port in the same session. Therefore, if an uplink port is not configured for a session, the assigned downlink ports will not be able to communicate with any other ports.
- ◆ If a downlink port is not configured for the session, the assigned uplink ports will operate as normal ports.

EXAMPLE

This example enables traffic segmentation, and then sets port 10 as the uplink and ports 5-8 as downlinks.

```
Console(config)#traffic-segmentation
Console(config)#traffic-segmentation uplink ethernet 1/10
downlink ethernet 1/5-8
Console(config)#
```

traffic-segmentation uplink-to-uplink

This command specifies whether or not traffic can be forwarded between uplink ports assigned to different client sessions. Use the **no** form to restore the default.

SYNTAX

[no] traffic-segmentation uplink-to-uplink {blocking | forwarding}

blocking – Blocks traffic between uplink ports assigned to different sessions.

forwarding – Forwards traffic between uplink ports assigned to different sessions.

DEFAULT SETTING

Blocking

COMMAND MODE

Global Configuration

EXAMPLE

This example enables forwarding of traffic between uplink ports assigned to different client sessions.

```
Console(config)#traffic-segmentation uplink-to-uplink forwarding
Console(config)#
```

show traffic-segmentation This command displays the configured traffic segments.

COMMAND MODE
Privileged Exec

EXAMPLE

```
Console#show traffic-segmentation
```

```
Private VLAN Status      :      Enabled  
Uplink-to-Uplink Mode    :      Forwarding
```

Session	Uplink Ports	Downlink Ports
1	Ethernet 1/1	Ethernet 1/2 Ethernet 1/3 Ethernet 1/4

```
Console#
```

Access Control Lists (ACL) provide packet filtering for IPv4 frames (based on address, protocol, Layer 4 protocol port number or TCP control code), IPv6 frames (based on address, DSCP traffic class, next header type, or any frames (based on MAC address or Ethernet type). To filter packets, first create an access list, add the required rules, and then bind the list to a specific port. This section describes the Access Control List commands.

Table 106: Access Control List Commands

Command Group	Function
IPv4 ACLs	Configures ACLs based on IPv4 addresses, TCP/UDP port number, protocol type, and TCP control code
IPv6 ACLs	Configures ACLs based on IPv6 addresses, DSCP traffic class, or next header type
MAC ACLs	Configures ACLs based on hardware addresses, packet format, and Ethernet type
ARP ACLs	Configures ACLs based on ARP messages addresses
ACL Information	Displays ACLs and associated rules; shows ACLs assigned to each port

IPv4 ACLs

The commands in this section configure ACLs based on IPv4 addresses, TCP/UDP port number, protocol type, and TCP control code. To configure IPv4 ACLs, first create an access list containing the required permit or deny rules, and then bind the access list to one or more ports.

Table 107: IPv4 ACL Commands

Command	Function	Mode
<code>access-list ip</code>	Creates an IP ACL and enters configuration mode for standard or extended IPv4 ACLs	GC
<code>permit, deny</code>	Filters packets matching a specified source IPv4 address	IPv4-STD-ACL
<code>permit, deny</code>	Filters packets meeting the specified criteria, including source and destination IPv4 address, TCP/UDP port number, protocol type, and TCP control code	IPv4-EXT-ACL
<code>ip access-group</code>	Binds an IPv4 ACL to a port	IC
<code>show ip access-group</code>	Shows port assignments for IPv4 ACLs	PE
<code>show ip access-list</code>	Displays the rules for configured IPv4 ACLs	PE

access-list ip This command adds an IP access list and enters configuration mode for standard or extended IPv4 ACLs. Use the **no** form to remove the specified ACL.

SYNTAX

[no] access-list ip {standard | extended} acl-name

standard – Specifies an ACL that filters packets based on the source IP address.

extended – Specifies an ACL that filters packets based on the source or destination IP address, and other more specific criteria.

acl-name – Name of the ACL. (Maximum length: 32 characters, no spaces or other special characters)

DEFAULT SETTING

None

COMMAND MODE

Global Configuration

COMMAND USAGE

- ◆ When you create a new ACL or enter configuration mode for an existing ACL, use the **permit** or **deny** command to add new rules to the bottom of the list.
- ◆ To remove a rule, use the **no permit** or **no deny** command followed by the exact text of a previously configured rule.
- ◆ An ACL can contain up to 64 rules.

EXAMPLE

```
Console(config)#access-list ip standard david
Console(config-std-acl)#
```

RELATED COMMANDS

[permit, deny \(971\)](#)

[ip access-group \(975\)](#)

[show ip access-list \(976\)](#)

permit, deny (Standard IP ACL) This command adds a rule to a Standard IPv4 ACL. The rule sets a filter condition for packets emanating from the specified source. Use the **no** form to remove a rule.

SYNTAX

```
{permit | deny}
  {any | source bitmask | host source}
  [time-range time-range-name]
```

```
no {permit | deny}
  {any | source bitmask | host source}
```

any – Any source IP address.

source – Source IP address.

bitmask – Dotted decimal number representing the address bits to match.

host – Keyword followed by a specific IP address.

time-range-name - Name of the time range.
(Range: 1-16 characters)

DEFAULT SETTING

None

COMMAND MODE

Standard IPv4 ACL

COMMAND USAGE

- ◆ New rules are appended to the end of the list.
- ◆ Address bit masks are similar to a subnet mask, containing four integers from 0 to 255, each separated by a period. The binary mask uses 1 bits to indicate “match” and 0 bits to indicate “ignore.” The bitmask is bitwise ANDed with the specified source IP address, and then compared with the address for each IP packet entering the port(s) to which this ACL has been assigned.

EXAMPLE

This example configures one permit rule for the specific address 10.1.1.21 and another rule for the address range 168.92.16.x – 168.92.31.x using a bitmask.

```
Console(config-std-acl)#permit host 10.1.1.21
Console(config-std-acl)#permit 168.92.16.0 255.255.240.0
Console(config-std-acl)#
```

RELATED COMMANDS

[access-list ip \(970\)](#)

[Time Range \(782\)](#)

permit, deny (Extended IPv4 ACL) This command adds a rule to an Extended IPv4 ACL. The rule sets a filter condition for packets with specific source or destination IP addresses, protocol types, source or destination protocol ports, or TCP control codes. Use the **no** form to remove a rule.

SYNTAX

```
{permit | deny} [protocol-number | udp]
  {any | source address-bitmask | host source}
  {any | destination address-bitmask | host destination}
  [precedence precedence] [dscp dscp]
  [source-port sport [bitmask]]
  [destination-port dport [port-bitmask]]
  [time-range time-range-name]
```

```
no {permit | deny} [protocol-number | udp]
  {any | source address-bitmask | host source}
  {any | destination address-bitmask | host destination}
  [precedence precedence] [dscp dscp]
  [source-port sport [bitmask]]
  [destination-port dport [port-bitmask]]
```

```
{permit | deny} tcp
  {any | source address-bitmask | host source}
  {any | destination address-bitmask | host destination}
  [precedence precedence] [dscp dscp]
  [source-port sport [bitmask]]
  [destination-port dport [port-bitmask]]
  [control-flag control-flags flag-bitmask]
  [time-range time-range-name]
```

```
no {permit | deny} tcp
  {any | source address-bitmask | host source}
  {any | destination address-bitmask | host destination}
  [precedence precedence] [dscp dscp]
  [source-port sport [bitmask]]
  [destination-port dport [port-bitmask]]
  [control-flag control-flags flag-bitmask]
```

protocol-number – A specific protocol number. (Range: 0-255)

source – Source IP address.

destination – Destination IP address.

address-bitmask – Decimal number representing the address bits to match.

host – Keyword followed by a specific IP address.

precedence – IP precedence level. (Range: 0-7)

dscp – DSCP priority level. (Range: 0-63)

sport – Protocol²² source port number. (Range: 0-65535)

dport – Protocol²² destination port number. (Range: 0-65535)

port-bitmask – Decimal number representing the port bits to match. (Range: 0-65535)

22. Includes TCP, UDP or other protocol types.

control-flags – Decimal number (representing a bit string) that specifies flag bits in byte 14 of the TCP header. (Range: 0-63)

flag-bitmask – Decimal number representing the code bits to match.

time-range-name - Name of the time range.
(Range: 1-16 characters)

DEFAULT SETTING

None

COMMAND MODE

Extended IPv4 ACL

COMMAND USAGE

- ◆ All new rules are appended to the end of the list.
- ◆ Address bit masks are similar to a subnet mask, containing four integers from 0 to 255, each separated by a period. The binary mask uses 1 bits to indicate “match” and 0 bits to indicate “ignore.” The bit mask is bitwise ANDed with the specified source IP address, and then compared with the address for each IP packet entering the port(s) to which this ACL has been assigned.
- ◆ You can specify both Precedence and ToS in the same rule. However, if DSCP is used, then neither Precedence nor ToS can be specified.
- ◆ The control-code bitmask is a decimal number (representing an equivalent bit mask) that is applied to the control code. Enter a decimal number, where the equivalent binary bit “1” means to match a bit and “0” means to ignore a bit. The following bits may be specified:
 - 1 (fin) – Finish
 - 2 (syn) – Synchronize
 - 4 (rst) – Reset
 - 8 (psh) – Push
 - 16 (ack) – Acknowledgement
 - 32 (urg) – Urgent pointer

For example, use the code value and mask below to catch packets with the following flags set:

- SYN flag valid, use “control-code 2 2”
 - Both SYN and ACK valid, use “control-code 18 18”
 - SYN valid and ACK invalid, use “control-code 2 18”
- ◆ Due to a ASIC limitation, the switch only checks the leftmost six priority bits. This presents no problem when checking DSCP or IP Precedence bits, but limits the checking of ToS bits (underlined in the following example) to the leftmost three bits, ignoring the rightmost fourth bit.

For example, if you configured an access list to deny packets with a ToS of 7 (00001110), the highlighted bit would be ignored, and the access list would drop packets with a ToS of both 6 and 7.

Table 108: Priority Bits Processed by Extended IPv4 ACL

DSCP								
Precedence			ToS					
7	6	5	4	3	2	1	0	

EXAMPLE

This example accepts any incoming packets if the source address is within subnet 10.7.1.x. For example, if the rule is matched; i.e., the rule (10.7.1.0 & 255.255.255.0) equals the masked address (10.7.1.2 & 255.255.255.0), the packet passes through.

```
Console(config-ext-acl)#permit 10.7.1.1 255.255.255.0 any
Console(config-ext-acl)#
```

This allows TCP packets from class C addresses 192.168.1.0 to any destination address when set for destination TCP port 80 (i.e., HTTP).

```
Console(config-ext-acl)#permit 192.168.1.0 255.255.255.0 any destination-port
80
Console(config-ext-acl)#
```

This permits all TCP packets from class C addresses 192.168.1.0 with the TCP control code set to "SYN."

```
Console(config-ext-acl)#permit tcp 192.168.1.0 255.255.255.0 any control-
flag 2 2
Console(config-ext-acl)#
```

RELATED COMMANDS

- [access-list ip \(970\)](#)
- [Time Range \(782\)](#)

ip access-group This command binds an IPv4 ACL to a port. Use the **no** form to remove the port.

SYNTAX

```
ip access-group acl-name in  
[time-range time-range-name] [counter]
```

```
no ip access-group acl-name in
```

acl-name – Name of the ACL. (Maximum length: 32 characters)

in – Indicates that this list applies to ingress packets.

time-range-name - Name of the time range.
(Range: 1-16 characters)

counter – Enables counter for ACL statistics.

DEFAULT SETTING

None

COMMAND MODE

Interface Configuration (Ethernet)

COMMAND USAGE

- ◆ Only one ACL can be bound to a port.
- ◆ If an ACL is already bound to a port and you bind a different ACL to it, the switch will replace the old binding with the new one.

EXAMPLE

```
Console(config)#int eth 1/2  
Console(config-if)#ip access-group david in  
Console(config-if)#
```

RELATED COMMANDS

[show ip access-list \(976\)](#)

[Time Range \(782\)](#)

show ip access-group This command shows the ports assigned to IP ACLs.

COMMAND MODE

Privileged Exec

EXAMPLE

```
Console#show ip access-group  
Interface ethernet 1/2  
IP access-list david in  
Console#
```

RELATED COMMANDS
[ip access-group \(975\)](#)

show ip access-list This command displays the rules for configured IPv4 ACLs.

SYNTAX

show ip access-list {**standard** | **extended**} [*acl-name*]
standard – Specifies a standard IP ACL.
extended – Specifies an extended IP ACL.
acl-name – Name of the ACL. (Maximum length: 32 characters)

COMMAND MODE
Privileged Exec

EXAMPLE

```
Console#show ip access-list standard
IP standard access-list david:
  permit host 10.1.1.21
  permit 168.92.0.0 255.255.15.0
Console#
```

RELATED COMMANDS
[permit, deny \(971\)](#)
[ip access-group \(975\)](#)

IPv6 ACLs

The commands in this section configure ACLs based on IPv6 addresses, DSCP traffic class, or next header type. To configure IPv6 ACLs, first create an access list containing the required permit or deny rules, and then bind the access list to one or more ports.

Table 109: IPv6 ACL Commands

Command	Function	Mode
access-list ipv6	Creates an IPv6 ACL and enters configuration mode for standard or extended IPv6 ACLs	GC
permit, deny	Filters packets matching a specified source IPv6 address	IPv6-STD-ACL
permit, deny	Filters packets meeting the specified criteria, including source or destination IPv6 address, DSCP traffic class, or next header type	IPv6-EXT-ACL
ipv6 access-group	Adds a port to an IPv6 ACL	IC
show ipv6 access-group	Shows port assignments for IPv6 ACLs	PE
show ipv6 access-list	Displays the rules for configured IPv6 ACLs	PE

access-list ipv6 This command adds an IP access list and enters configuration mode for standard or extended IPv6 ACLs. Use the **no** form to remove the specified ACL.

SYNTAX

[no] access-list ipv6 {standard | extended} acl-name

standard – Specifies an ACL that filters packets based on the source IP address.

extended – Specifies an ACL that filters packets based on the destination IP address, and other more specific criteria.

acl-name – Name of the ACL. (Maximum length: 32 characters)

DEFAULT SETTING

None

COMMAND MODE

Global Configuration

COMMAND USAGE

- ◆ When you create a new ACL or enter configuration mode for an existing ACL, use the **permit** or **deny** command to add new rules to the bottom of the list. To create an ACL, you must add at least one rule to the list.
- ◆ To remove a rule, use the **no permit** or **no deny** command followed by the exact text of a previously configured rule.
- ◆ An ACL can contain up to 64 rules.

EXAMPLE

```
Console(config)#access-list ipv6 standard david
Console(config-std-ipv6-acl)#
```

RELATED COMMANDS

[permit, deny \(Standard IPv6 ACL\) \(978\)](#)
[permit, deny \(Extended IPv6 ACL\) \(979\)](#)
[ipv6 access-group \(981\)](#)
[show ipv6 access-list \(982\)](#)

permit, deny (Standard IPv6 ACL) This command adds a rule to a Standard IPv6 ACL. The rule sets a filter condition for packets emanating from the specified source. Use the **no** form to remove a rule.

SYNTAX

```
{permit | deny}  
  {any | host source-ipv6-address |  
  source-ipv6-address[/prefix-length]}  
  [time-range time-range-name]  
no {permit | deny} {any | host source-ipv6-address |  
  source-ipv6-address[/prefix-length]}
```

any – Any source IP address.

host – Keyword followed by a specific IP address.

source-ipv6-address - An IPv6 source address or network class. The address must be formatted according to RFC 2373 "IPv6 Addressing Architecture," using 8 colon-separated 16-bit hexadecimal values. One double colon may be used in the address to indicate the appropriate number of zeros required to fill the undefined fields.

prefix-length - A decimal value indicating how many contiguous bits (from the left) of the address comprise the prefix; i.e., the network portion of the address. (Range: 0-128)

time-range-name - Name of the time range.
(Range: 1-16 characters)

DEFAULT SETTING

None

COMMAND MODE

Standard IPv6 ACL

COMMAND USAGE

New rules are appended to the end of the list.

EXAMPLE

This example configures one permit rule for the specific address 2009:DB9:2229::79 and another rule for the addresses with the network prefix 2009:DB9:2229:5::/64.

```
Console(config-std-ipv6-acl)#permit host 2009:DB9:2229::79  
Console(config-std-ipv6-acl)#permit 2009:DB9:2229:5::/64  
Console(config-std-ipv6-acl)#
```

RELATED COMMANDS

[access-list ipv6 \(977\)](#)

[Time Range \(782\)](#)

permit, deny (Extended IPv6 ACL) This command adds a rule to an Extended IPv6 ACL. The rule sets a filter condition for packets with specific source or destination IP addresses, or next header type. Use the **no** form to remove a rule.

SYNTAX

```
{permit | deny}
  {any | host source-ipv6-address |
  source-ipv6-address[/prefix-length]}
  {any | destination-ipv6-address[/prefix-length]} [dscp dscp]
  [next-header next-header] [time-range time-range-name]
```

```
no {permit | deny} {any | host source-ipv6-address |
  source-ipv6-address[/prefix-length]}
  {any | destination-ipv6-address[/prefix-length]} [dscp dscp]
  [next-header next-header]
```

any – Any IP address (an abbreviation for the IPv6 prefix `::/0`).

host – Keyword followed by a specific source IP address.

source-ipv6-address - An IPv6 source address or network class. The address must be formatted according to RFC 2373 "IPv6 Addressing Architecture," using 8 colon-separated 16-bit hexadecimal values. One double colon may be used in the address to indicate the appropriate number of zeros required to fill the undefined fields.

destination-ipv6-address - An IPv6 destination address or network class. The address must be formatted according to RFC 2373 "IPv6 Addressing Architecture," using 8 colon-separated 16-bit hexadecimal values. One double colon may be used in the address to indicate the appropriate number of zeros required to fill the undefined fields. (The switch only checks the first 64 bits of the destination address.)

prefix-length - A decimal value indicating how many contiguous bits (from the left) of the address comprise the prefix; i.e., the network portion of the address. (Range: 0-128 for source prefix, 0-8 for destination prefix)

dscp – DSCP traffic class. (Range: 0-63)

next-header – Identifies the type of header immediately following the IPv6 header. (Range: 0-255)

time-range-name - Name of the time range. (Range: 1-16 characters)

DEFAULT SETTING

None

COMMAND MODE

Extended IPv6 ACL

COMMAND USAGE

- ◆ All new rules are appended to the end of the list.

- ◆ Optional internet-layer information is encoded in separate headers that may be placed between the IPv6 header and the upper-layer header in a packet. There are a small number of such extension headers, each identified by a distinct Next Header value. IPv6 supports the values defined for the IPv4 Protocol field in RFC 1700, including these commonly used headers:

0	: Hop-by-Hop Options	(RFC 2460)
6	: TCP Upper-layer Header	(RFC 1700)
17	: UDP Upper-layer Header	(RFC 1700)
43	: Routing	(RFC 2460)
44	: Fragment	(RFC 2460)
51	: Authentication	(RFC 2402)
50	: Encapsulating Security Payload	(RFC 2406)
60	: Destination Options	(RFC 2460)

EXAMPLE

This example accepts any incoming packets if the destination address is 2009:DB9:2229::79/8.

```
Console(config-ext-ipv6-acl)#permit 2009:DB9:2229::79/8
Console(config-ext-ipv6-acl)#
```

This allows packets to any destination address when the DSCP value is 5.

```
Console(config-ext-ipv6-acl)#permit any dscp 5
Console(config-ext-ipv6-acl)#
```

This allows any packets sent to the destination 2009:DB9:2229::79/48 when the next header is 43.”

```
Console(config-ext-ipv6-acl)#permit 2009:DB9:2229::79/48 next-header 43
Console(config-ext-ipv6-acl)#
```

RELATED COMMANDS

[access-list ipv6 \(977\)](#)

[Time Range \(782\)](#)

ipv6 access-group This command binds a port to an IPv6 ACL. Use the **no** form to remove the port.

SYNTAX

```
ipv6 access-group acl-name in  
[time-range time-range-name] [counter]
```

```
no ipv6 access-group acl-name in
```

acl-name – Name of the ACL. (Maximum length: 32 characters)

in – Indicates that this list applies to ingress packets.

time-range-name – Name of the time range.
(Range: 1-16 characters)

counter – Enables counter for ACL statistics.

DEFAULT SETTING

None

COMMAND MODE

Interface Configuration (Ethernet)

COMMAND USAGE

- ◆ A port can only be bound to one ACL.
- ◆ If a port is already bound to an ACL and you bind it to a different ACL, the switch will replace the old binding with the new one.
- ◆ IPv6 ACLs can only be applied to ingress packets.

EXAMPLE

```
Console(config)#interface ethernet 1/2  
Console(config-if)#ipv6 access-group standard david in  
Console(config-if)#
```

RELATED COMMANDS

[show ipv6 access-list \(982\)](#)

[Time Range \(782\)](#)

show ipv6 access-group This command shows the ports assigned to IPv6 ACLs.

COMMAND MODE

Privileged Exec

EXAMPLE

```
Console#show ipv6 access-group  
Interface ethernet 1/2  
IPv6 standard access-list david in  
Console#
```

RELATED COMMANDS

[ipv6 access-group \(981\)](#)

show ipv6 access-list This command displays the rules for configured IPv6 ACLs.

SYNTAX

show ipv6 access-list {**standard** | **extended**} [*acl-name*]

standard – Specifies a standard IPv6 ACL.

extended – Specifies an extended IPv6 ACL.

acl-name – Name of the ACL. (Maximum length: 32 characters)

COMMAND MODE

Privileged Exec

EXAMPLE

```
Console#show ipv6 access-list standard
IPv6 standard access-list david:
  permit host 2009:DB9:2229::79
  permit 2009:DB9:2229:5::/64
Console#
```

RELATED COMMANDS

[permit, deny \(Standard IPv6 ACL\) \(978\)](#)

[permit, deny \(Extended IPv6 ACL\) \(979\)](#)

[ipv6 access-group \(981\)](#)

MAC ACLs

The commands in this section configure ACLs based on hardware addresses, packet format, and Ethernet type. The ACLs can further specify optional IP and IPv6 addresses including protocol type and upper layer ports. To configure MAC ACLs, first create an access list containing the required permit or deny rules, and then bind the access list to one or more ports.

Table 110: MAC ACL Commands

Command	Function	Mode
<code>access-list mac</code>	Creates a MAC ACL and enters configuration mode	GC
<code>permit, deny</code>	Filters packets matching a specified source and destination address, packet format, and Ethernet type. They can be further specified using optional IP and IPv6 addresses including protocol type and upper layer ports.	MAC-ACL
<code>mac access-group</code>	Binds a MAC ACL to a port	IC
<code>show mac access-group</code>	Shows port assignments for MAC ACLs	PE
<code>show mac access-list</code>	Displays the rules for configured MAC ACLs	PE

access-list mac This command enters MAC ACL configuration mode. Rules can be added to filter packets matching a specified MAC source or destination address (i.e., physical layer address), or Ethernet protocol type. Rules can also be used to filter packets based on IPv4/v6 addresses, including Layer 4 ports and protocol types. Use the **no** form to remove the specified ACL.

SYNTAX

[no] access-list mac *acl-name*

acl-name – Name of the ACL. (Maximum length: 32 characters, no spaces or other special characters)

DEFAULT SETTING

None

COMMAND MODE

Global Configuration

COMMAND USAGE

- ◆ When you create a new ACL or enter configuration mode for an existing ACL, use the **permit** or **deny** command to add new rules to the bottom of the list.
- ◆ To remove a rule, use the **no permit** or **no deny** command followed by the exact text of a previously configured rule.
- ◆ An ACL can contain up to 64 rules.

EXAMPLE

```
Console(config)#access-list mac jerry
Console(config-mac-acl)#
```

RELATED COMMANDS

[permit, deny \(984\)](#)
[mac access-group \(987\)](#)
[show mac access-list \(988\)](#)

permit, deny (MAC ACL) This command adds a rule to a MAC ACL. The rule filters packets matching a specified MAC source or destination address (i.e., physical layer address), or Ethernet protocol type. Use the **no** form to remove a rule.

SYNTAX

```
{permit | deny}
  {any | host source | source address-bitmask}
  {any | host destination | destination address-bitmask}
  [vid vid vid-bitmask] [ethertype protocol [protocol-bitmask]]
  {{ip {any | host source-ip | source-ip network-mask}
    {any | host destination-ip | destination-ip network-mask}
  }
  {ipv6 {any | host source-ipv6 | source-ipv6/prefix-length}
    {any | host destination-ipv6 | destination-ipv6/prefix-length}}
  [protocol protocol]
  [14-source-port sport [port-bitmask]]
  [14-destination-port dport [port-bitmask]]]
  [time-range time-range-name]

no {permit | deny}
  {any | host source | source address-bitmask}
  {any | host destination | destination address-bitmask}
  [vid vid vid-bitmask] [ethertype protocol [protocol-bitmask]]
  {{ip {any | host source-ip | source-ip network-mask}
    {any | host destination-ip | destination-ip network-mask}
  }
  {ipv6 {any | host source-ipv6 | source-ipv6/prefix-length}
    {any | host destination-ipv6 | destination-ipv6/prefix-length}}
  [protocol protocol]
  [14-source-port sport [port-bitmask]]
  [14-destination-port dport [port-bitmask]]]
```



NOTE: The default is for Ethernet II packets.

```

{permit | deny} tagged-eth2
  {any | host source | source address-bitmask}
  {any | host destination | destination address-bitmask}
  [vid vid vid-bitmask] [ethertype ethertype [ethertype-bitmask]]
  {{ip {any | host source-ip | source-ip network-mask}
    {any | host destination-ip | destination-ip network-mask}
  }}
  {ipv6 {any | host source-ipv6 | source-ipv6/prefix-length}
    {any | host destination-ipv6 | destination-ipv6/prefix-length}}
  [protocol protocol]
  [14-source-port sport [port-bitmask]]
  [14-destination-port dport [port-bitmask]]}

no {permit | deny} tagged-eth2
  {any | host source | source address-bitmask}
  {any | host destination | destination address-bitmask}
  [vid vid vid-bitmask] [ethertype ethertype [ethertype-bitmask]]
  {{ip {any | host source-ip | source-ip network-mask}
    {any | host destination-ip | destination-ip network-mask}
  }}
  {ipv6 {any | host source-ipv6 | source-ipv6/prefix-length}
    {any | host destination-ipv6 | destination-ipv6/prefix-length}}
  [protocol protocol]
  [14-source-port sport [port-bitmask]]
  [14-destination-port dport [port-bitmask]]}

{permit | deny} untagged-eth2
  {any | host source | source address-bitmask}
  {any | host destination | destination address-bitmask}
  [ethertype ethertype [ethertype-bitmask]]
  {{ip {any | host source-ip | source-ip network-mask}
    {any | host destination-ip | destination-ip network-mask}
  }}
  {ipv6 {any | host source-ipv6 | source-ipv6/prefix-length}
    {any | host destination-ipv6 | destination-ipv6/prefix-length}}
  [protocol protocol]
  [14-source-port sport [port-bitmask]]
  [14-destination-port dport [port-bitmask]]}

no {permit | deny} untagged-eth2
  {any | host source | source address-bitmask}
  {any | host destination | destination address-bitmask}
  [ethertype ethertype [ethertype-bitmask]]
  {{ip {any | host source-ip | source-ip network-mask}
    {any | host destination-ip | destination-ip network-mask}
  }}
  {ipv6 {any | host source-ipv6 | source-ipv6/prefix-length}
    {any | host destination-ipv6 | destination-ipv6/prefix-length}}
  [protocol protocol]
  [14-source-port sport [port-bitmask]]
  [14-destination-port dport [port-bitmask]]}

{permit | deny} tagged-802.3
  {any | host source | source address-bitmask}
  {any | host destination | destination address-bitmask}
  [vid vid vid-bitmask] [time-range time-range-name]

```

no {permit | deny} tagged-802.3
 {any | host source | source address-bitmask}
 {any | host destination | destination address-bitmask}
 [vid vid vid-bitmask]

{permit | deny} untagged-802.3
 {any | host source | source address-bitmask}
 {any | host destination | destination address-bitmask}
 [time-range time-range-name]

no {permit | deny} untagged-802.3
 {any | host source | source address-bitmask}
 {any | host destination | destination address-bitmask}

tagged-eth2 – Tagged Ethernet II packets.

untagged-eth2 – Untagged Ethernet II packets.

tagged-802.3 – Tagged Ethernet 802.3 packets.

untagged-802.3 – Untagged Ethernet 802.3 packets.

any – Any MAC, IPv4 or IPv6 source or destination address.

host – A specific MAC, IPv4 or IPv6 address.

source – Source MAC, IPv4 or IPv6 address.

destination – Destination MAC, IPv4 or IPv6 address.

*address-bitmask*²³ – Bitmask for MAC address (in hexadecimal format).

network-mask – Network mask for IP subnet. This mask identifies the host address bits used for routing to specific subnets.

prefix-length - Length of IPv6 prefix. A decimal value indicating how many contiguous bits (from the left) of the address comprise the prefix; i.e., the network portion of the address. (Range: 0-128/52)

vid – VLAN ID. (Range: 1-4094)

*vid-bitmask*²³ – VLAN bitmask. (Range: 1-4095)

ethertype – A specific Ethernet protocol number. (Range: 0-ffff hex)

*ethertype-bitmask*²³ – Protocol bitmask. (Range: 0-ffff hex)

protocol - IP protocol or IPv6 next header. (Range: 0-255)

For information on next headers, see [permit, deny \(Extended IPv6 ACL\)](#).

*sport*²⁴ – Protocol source port number. (Range: 0-65535)

*dport*²⁴ – Protocol destination port number. (Range: 0-65535)

port-bitmask – Decimal number representing the port bits to match. (Range: 0-65535)

time-range-name - Name of the time range. (Range: 1-16 characters)

23. For all bitmasks, “1” means relevant and “0” means ignore.

24. Includes TCP, UDP or other protocol types.

DEFAULT SETTING

None

COMMAND MODE

MAC ACL

COMMAND USAGE

- ◆ New rules are added to the end of the list.
- ◆ The **ethertype** option can only be used to filter Ethernet II formatted packets.
- ◆ A detailed listing of Ethernet protocol types can be found in RFC 1060. A few of the more common types include the following:
 - 0800 - IP
 - 0806 - ARP
 - 8137 - IPX

EXAMPLE

This rule permits packets from any source MAC address to the destination address 00-e0-29-94-34-de where the Ethernet type is 0800.

```
Console(config-mac-acl)#permit any host 00-e0-29-94-34-de ethertype 0800
Console(config-mac-acl)#
```

RELATED COMMANDS[access-list mac \(983\)](#)[Time Range \(782\)](#)

mac access-group This command binds a MAC ACL to a port. Use the **no** form to remove the port.

SYNTAX

```
mac access-group acl-name in
[time-range time-range-name] [counter]
```

acl-name – Name of the ACL. (Maximum length: 32 characters)

in – Indicates that this list applies to ingress packets.

time-range-name - Name of the time range.
(Range: 1-16 characters)

counter – Enables counter for ACL statistics.

DEFAULT SETTING

None

COMMAND MODE

Interface Configuration (Ethernet)

COMMAND USAGE

- ◆ Only one ACL can be bound to a port.
- ◆ If an ACL is already bound to a port and you bind a different ACL to it, the switch will replace the old binding with the new one.

EXAMPLE

```
Console(config)#interface ethernet 1/2
Console(config-if)#mac access-group jerry in
Console(config-if)#
```

RELATED COMMANDS

[show mac access-list \(988\)](#)
[Time Range \(782\)](#)

show mac access-group

This command shows the ports assigned to MAC ACLs.

COMMAND MODE

Privileged Exec

EXAMPLE

```
Console#show mac access-group
Interface ethernet 1/5
MAC access-list M5 in
Console#
```

RELATED COMMANDS

[mac access-group \(987\)](#)

show mac access-list

This command displays the rules for configured MAC ACLs.

SYNTAX

show mac access-list [*acl-name*]

acl-name – Name of the ACL. (Maximum length: 32 characters)

COMMAND MODE

Privileged Exec

EXAMPLE

```
Console#show mac access-list
MAC access-list jerry:
  permit any 00-e0-29-94-34-de ethertype 0800
Console#
```

RELATED COMMANDS

[permit, deny \(984\)](#)
[mac access-group \(987\)](#)

ARP ACLs

The commands in this section configure ACLs based on the IP or MAC address contained in ARP request and reply messages. To configure ARP ACLs, first create an access list containing the required permit or deny rules, and then bind the access list to one or more VLANs using the [ip arp inspection vlan](#) command ([page 953](#)).

Table 111: ARP ACL Commands

Command	Function	Mode
access-list arp	Creates a ARP ACL and enters configuration mode	GC
permit, deny	Filters packets matching a specified source or destination address in ARP messages	ARP-ACL
show access-list arp	Displays the rules for configured ARP ACLs	PE

access-list arp This command adds an ARP access list and enters ARP ACL configuration mode. Use the **no** form to remove the specified ACL.

SYNTAX

[no] access-list arp *acl-name*

acl-name – Name of the ACL. (Maximum length: 32 characters)

DEFAULT SETTING

None

COMMAND MODE

Global Configuration

COMMAND USAGE

- ◆ When you create a new ACL or enter configuration mode for an existing ACL, use the **permit** or **deny** command to add new rules to the bottom of the list. To create an ACL, you must add at least one rule to the list.
- ◆ To remove a rule, use the **no permit** or **no deny** command followed by the exact text of a previously configured rule.
- ◆ An ACL can contain up to 128 rules.

EXAMPLE

```
Console(config)#access-list arp factory
Console(config-arp-acl)#
```

RELATED COMMANDS

permit, deny (990)
show access-list arp (991)

permit, deny (ARP ACL) This command adds a rule to an ARP ACL. The rule filters packets matching a specified source or destination address in ARP messages. Use the **no** form to remove a rule.

SYNTAX

```
[no] {permit | deny}  
ip {any | host source-ip | source-ip ip-address-bitmask}  
mac {any | host source-mac | source-mac mac-address-bitmask}  
[log]
```

This form indicates either request or response packets.

```
[no] {permit | deny} request  
ip {any | host source-ip | source-ip ip-address-bitmask}  
mac {any | host source-mac | source-mac mac-address-bitmask}  
[log]
```

```
[no] {permit | deny} response  
ip {any | host source-ip | source-ip ip-address-bitmask}  
{any | host destination-ip | destination-ip ip-address-bitmask}  
mac {any | host source-mac | source-mac mac-address-bitmask}  
[any | host destination-mac | destination-mac mac-address-bitmask] [log]
```

source-ip – Source IP address.

destination-ip – Destination IP address with bitmask.

*ip-address-bitmask*²⁵ – IPv4 number representing the address bits to match.

source-mac – Source MAC address.

destination-mac – Destination MAC address range with bitmask.

*mac-address-bitmask*²⁵ – Bitmask for MAC address (in hexadecimal format).

log - Logs a packet when it matches the access control entry.

DEFAULT SETTING

None

COMMAND MODE

ARP ACL

COMMAND USAGE

New rules are added to the end of the list.

25. For all bitmasks, binary “1” means care and “0” means ignore.

EXAMPLE

This rule permits packets from any source IP and MAC address to the destination subnet address 192.168.0.0.

```
Console(config-arp-acl)#$permit response ip any 192.168.0.0 255.255.0.0 mac
any any
Console(config-mac-acl)#
```

RELATED COMMANDS

[access-list arp \(989\)](#)

show access-list arp This command displays the rules for configured ARP ACLs.

SYNTAX

show access-list arp [*acl-name*]

acl-name – Name of the ACL. (Maximum length: 32 characters)

COMMAND MODE

Privileged Exec

EXAMPLE

```
Console#show access-list arp
ARP access-list factory:
  permit response ip any 192.168.0.0 255.255.0.0 mac any any
Console#
```

RELATED COMMANDS

[permit, deny \(990\)](#)

ACL INFORMATION

This section describes commands used to display ACL information.

Table 112: ACL Information Commands

Command	Function	Mode
<code>clear access-list hardware counters</code>	Clears hit counter for rules in all ACLs, or in a specified ACL.	PE
<code>show access-group</code>	Shows the ACLs assigned to each port	PE
<code>show access-list</code>	Show all ACLs and associated rules	PE

clear access-list hardware counters

This command clears the hit counter for the rules in all ACLs, or for the rules in a specified ACL.

SYNTAX

clear access-list hardware counters

[direction in [interface *interface*]] | [interface *interface*] | [name *acl-name*]

in – Clears counter for ingress rules.

interface

ethernet *unit/port*

unit - Unit identifier. (Range: 1)

port - Port number. (Range: 1-28/52)

acl-name – Name of the ACL. (Maximum length: 32 characters)

COMMAND MODE

Privileged Exec

EXAMPLE

```
Console#clear access-list hardware counters
Console#
```

show access-group

This command shows the port assignments of ACLs.

COMMAND MODE

Privileged Executive

EXAMPLE

```
Console#show access-group
Interface ethernet 1/2
IP access-list david
```

```
MAC access-list jerry
Console#
```

show access-list This command shows all ACLs and associated rules.

SYNTAX

show access-list

```
[[arp [acl-name]] |
[ip [extended [acl-name] | standard [acl-name]] |
[ipv6 [extended [acl-name] | standard [acl-name]] |
[mac [acl-name]] | [tcam-utilization] | [hardware counters]]
```

arp – Shows ingress or egress rules for ARP ACLs.

hardware counters – Shows statistics for all ACLs.²⁶

ip extended – Shows ingress rules for Extended IPv4 ACLs.

ip standard – Shows ingress rules for Standard IPv4 ACLs.

ipv6 extended – Shows ingress rules for Extended IPv6 ACLs.

ipv6 standard – Shows ingress rules for Standard IPv6 ACLs.

mac – Shows ingress rules for MAC ACLs.

tcam-utilization – Shows the percentage of user configured ACL rules as a percentage of total ACL rules

acl-name – Name of the ACL. (Maximum length: 32 characters)

COMMAND MODE

Privileged Exec

EXAMPLE

```
Console#show access-list
IP standard access-list david:
  permit host 10.1.1.21
  permit 168.92.0.0 255.255.15.0
IP extended access-list bob:
  permit 10.7.1.1 255.255.255.0 any
  permit 192.168.1.0 255.255.255.0 any destination-port 80 80
  permit 192.168.1.0 255.255.255.0 any protocol tcp control-code 2 2
MAC access-list jerry:
  permit any host 00-30-29-94-34-de ethertype 800 800
IP extended access-list A6:
  deny tcp any any control-flag 2 2
  permit any any
Console#
```

26. Due to a hardware limitation, this option only displays statistics for permit rules.

These commands are used to display or set communication parameters for an Ethernet port, aggregated link, or VLAN; or perform cable diagnostics on the specified interface.

Table 113: Interface Commands

Command	Function	Mode
<i>Interface Configuration</i>		
<code>interface</code>	Configures an interface type and enters interface configuration mode	GC
<code>alias</code>	Configures an alias name for the interface	IC
<code>capabilities</code>	Advertises the capabilities of a given interface for use in autonegotiation	IC
<code>description</code>	Adds a description to an interface configuration	IC
<code>discard</code>	Discards CDP or PVST packets	IC
<code>flowcontrol</code>	Enables flow control on a given interface	IC
<code>media-type</code>	Forces the transceiver mode to use for SFP ports	IC
<code>negotiation</code>	Enables autonegotiation of a given interface	IC
<code>shutdown</code>	Disables an interface	IC
<code>speed-duplex</code>	Configures the speed and duplex operation of a given interface when autonegotiation is disabled	IC
<code>clear counters</code>	Clears statistics on an interface	PE
<code>show discard</code>	Displays if CDP and PVST packets are being discarded	PE
<code>show interfaces brief</code>	Displays a summary of key information, including operational status, native VLAN ID, default priority, speed/duplex mode, and port type	PE
<code>show interfaces counters</code>	Displays statistics for the specified interfaces	NE, PE
<code>show interfaces status</code>	Displays status for the specified interface	NE, PE
<code>show interfaces switchport</code>	Displays the administrative and operational status of an interface	NE, PE
<i>Transceiver Threshold Configuration</i>		
<code>transceiver-monitor</code>	Sends a trap when any of the transceiver's operational values fall outside specified thresholds	IC
<code>transceiver-threshold-auto</code>	Uses default threshold settings obtained from the transceiver to determine when an alarm or trap message should be sent	IC
<code>transceiver-threshold current</code>	Sets thresholds for transceiver current which can be used to trigger an alarm or warning message	IC
<code>transceiver-threshold rx-power</code>	Sets thresholds for the transceiver power level of the received signal which can be used to trigger an alarm or warning message	IC

Table 113: Interface Commands (Continued)

Command	Function	Mode
<code>transceiver-threshold temperature</code>	Sets thresholds for the transceiver temperature which can be used to trigger an alarm or warning message	IC
<code>transceiver-threshold tx-power</code>	Sets thresholds for the transceiver power level of the transmitted signal which can be used to trigger an alarm or warning message	IC
<code>transceiver-threshold voltage</code>	Sets thresholds for the transceiver voltage which can be used to trigger an alarm or warning message	IC
<code>show interfaces transceiver</code>	Displays the temperature, voltage, bias current, transmit power, and receive power	PE
<code>show interfaces transceiver-threshold</code>	Displays the alarm/warning thresholds for temperature, voltage, bias current, transmit power, and receive power	PE
<i>Cable Diagnostics</i>		
<code>test cable-diagnostics</code>	Performs cable diagnostics on the specified port	PE
<code>show cable-diagnostics</code>	Shows the results of a cable diagnostics test	PE
<i>Power Savings</i>		
<code>power-save</code>	Enables power savings mode on the specified port	IC
<code>show power-save</code>	Shows the configuration settings for power savings	PE

Interface Configuration

interface This command configures an interface type and enters interface configuration mode. Use the **no** form with a trunk to remove an inactive interface.

SYNTAX

[no] interface *interface-list*

interface-list – One or more ports. Use a hyphen to indicate a consecutive list of ports or a comma between non-consecutive ports.

ethernet *unit/port*

unit - Unit identifier. (Range: 1)

port - Port number. (Range: 1-28/52)

port-channel *channel-id* (Range: 1-16)

vlan *vlan-id* (Range: 1-4094)

DEFAULT SETTING

None

COMMAND MODE

Global Configuration

EXAMPLE

To specify several different ports, enter the following command:

```
Console(config)#interface ethernet 1/17-20,23
Console(config-if)#shutdown
```

alias This command configures an alias name for the interface. Use the **no** form to remove the alias name.

SYNTAX

alias *string*

no alias

string - A mnemonic name to help you remember what is attached to this interface. (Range: 1-64 characters)

DEFAULT SETTING

None

COMMAND MODE

Interface Configuration (Ethernet, Port Channel)

COMMAND USAGE

The alias is displayed in the running-configuration file. An example of the value which a network manager might store in this object for a WAN interface is the (Telco's) circuit number/identifier of the interface.

EXAMPLE

The following example adds an alias to port 4.

```
Console(config)#interface ethernet 1/4
Console(config-if)#alias finance
Console(config-if)#
```

capabilities This command advertises the port capabilities of a given interface during auto-negotiation. Use the **no** form with parameters to remove an advertised capability, or the **no** form without parameters to restore the default values.

SYNTAX

[no] capabilities {1000full | 100full | 100half | 10full | 10half | flowcontrol}

1000full - Supports 1 Gbps full-duplex operation

100full - Supports 100 Mbps full-duplex operation

100half - Supports 100 Mbps half-duplex operation

10full - Supports 10 Mbps full-duplex operation

10half - Supports 10 Mbps half-duplex operation

flowcontrol - Supports flow control

DEFAULT SETTING

100BASE-FX: 100full (SFP)

1000BASE-T: 10half, 10full, 100half, 100full, 1000full

1000BASE-SX/LX/LH (SFP): 1000full

COMMAND MODE

Interface Configuration (Ethernet, Port Channel)

COMMAND USAGE

- ◆ The 1000BASE-T standard does not support forced mode. Auto-negotiation should always be used to establish a connection over any 1000BASE-T port or trunk.
- ◆ When auto-negotiation is enabled with the [negotiation](#) command, the switch will negotiate the best settings for a link based on the **capabilities** command. When auto-negotiation is disabled, you must manually specify the link attributes with the [speed-duplex](#) and [flowcontrol](#) commands.

EXAMPLE

The following example configures Ethernet port 5 capabilities to include 100half and 100full.

```
Console(config)#interface ethernet 1/5
Console(config-if)#capabilities 100half
Console(config-if)#capabilities 100full
Console(config-if)#capabilities flowcontrol
Console(config-if)#
```

RELATED COMMANDS

[negotiation \(1001\)](#)
[speed-duplex \(1002\)](#)
[flowcontrol \(1000\)](#)

description This command adds a description to an interface. Use the **no** form to remove the description.

SYNTAX

description *string*

no description

string - Comment or a description to help you remember what is attached to this interface. (Range: 1-64 characters)

DEFAULT SETTING

None

COMMAND MODE

Interface Configuration (Ethernet, Port Channel)

COMMAND USAGE

The description is displayed by the [show interfaces status](#) command and in the running-configuration file. An example of the value which a network manager might store in this object is the name of the manufacturer, and the product name.

EXAMPLE

The following example adds a description to port 4.

```
Console(config)#interface ethernet 1/4
Console(config-if)#description RD-SW#3
Console(config-if)#
```

discard This command discards CDP or PVST packets. Use the **no** form to forward the specified packet type to other ports configured the same way.

SYNTAX

```
[no] discard { cdp | pvst }
```

cdp – Cisco Discovery Protocol

pvst – Per-VLAN Spanning Tree

DEFAULT SETTING

Default - Forward CDP and PVST packets

COMMAND MODE

Interface Configuration (Ethernet)

COMMAND USAGE

Use the **no discard** command to allow CDP or PVST packets to be forwarded to other ports in the same VLAN which are also configured to forward the specified packet type.

EXAMPLE

The following example forwards CDP packets entering port 5.

```
Console(config)#interface ethernet 1/5
Console(config-if)#no discard cdp
Console(config-if)#
```

flowcontrol This command enables flow control. Use the **no** form to disable flow control.

SYNTAX

[no] **flowcontrol**

DEFAULT SETTING

Disabled

COMMAND MODE

Interface Configuration (Ethernet, Port Channel)

COMMAND USAGE

- ◆ 1000BASE-T does not support forced mode. Auto-negotiation should always be used to establish a connection over any 1000BASE-T port or trunk.
- ◆ Flow control can eliminate frame loss by “blocking” traffic from end stations or segments connected directly to the switch when its buffers fill. When enabled, back pressure is used for half-duplex operation and IEEE 802.3-2002 (formally IEEE 802.3x) for full-duplex operation.
- ◆ To force flow control on or off (with the **flowcontrol** or **no flowcontrol** command), use the **no negotiation** command to disable auto-negotiation on the selected interface.
- ◆ When using the [negotiation](#) command to enable auto-negotiation, the optimal settings will be determined by the [capabilities](#) command. To enable flow control under auto-negotiation, “flowcontrol” must be included in the capabilities list for any port

EXAMPLE

The following example enables flow control on port 5.

```
Console(config)#interface ethernet 1/5
Console(config-if)#flowcontrol
Console(config-if)#no negotiation
Console(config-if)#
```

RELATED COMMANDS

[negotiation \(1001\)](#)

[capabilities \(flowcontrol, symmetric\) \(997\)](#)

media-type This command forces the transceiver mode to use for SFP ports. Use the **no** form to restore the default mode.

SYNTAX

media-type sfp-forced {**1000sfp** | **100fx**}

no media-type

1000sfp - Forces the port to use 1000BASE SFP mode

100fx - Forces the port to use 100BASE-FX mode

DEFAULT SETTING

Not specified

COMMAND MODE

Interface Configuration (SFP Ports)

EXAMPLE

This forces the switch to use the built-in RJ-45 port for the combination port 10.

```
Console(config)#interface ethernet 1/11
Console(config-if)#media-type sfp-forced 1000sfp
Console(config-if)#
```

negotiation This command enables auto-negotiation for a given interface. Use the **no** form to disable auto-negotiation.

SYNTAX

[no] negotiation

DEFAULT SETTING

Enabled

COMMAND MODE

Interface Configuration (Ethernet, Port Channel)

COMMAND USAGE

- ◆ 1000BASE-T does not support forced mode. Auto-negotiation should always be used to establish a connection over any 1000BASE-T port or trunk.
- ◆ When auto-negotiation is enabled the switch will negotiate the best settings for a link based on the [capabilities](#) command. When auto-negotiation is disabled, you must manually specify the link attributes with the [speed-duplex](#) and [flowcontrol](#) commands.
- ◆ If auto-negotiation is disabled, auto-MDI/MDI-X pin signal configuration will also be disabled for the RJ-45 ports.

EXAMPLE

The following example configures port 11 to use auto-negotiation.

```
Console(config)#interface ethernet 1/11
Console(config-if)#negotiation
Console(config-if)#
```

RELATED COMMANDS

[capabilities \(997\)](#)

[speed-duplex \(1002\)](#)

shutdown This command disables an interface. To restart a disabled interface, use the **no** form.

SYNTAX

[no] shutdown

DEFAULT SETTING

All interfaces are enabled.

COMMAND MODE

Interface Configuration (Ethernet, Port Channel)

COMMAND USAGE

This command allows you to disable a port due to abnormal behavior (e.g., excessive collisions), and then re-enable it after the problem has been resolved. You may also want to disable a port for security reasons.

EXAMPLE

The following example disables port 5.

```
Console(config)#interface ethernet 1/5
Console(config-if)#shutdown
Console(config-if)#
```

speed-duplex This command configures the speed and duplex mode of a given interface when auto-negotiation is disabled. Use the **no** form to restore the default.

SYNTAX

speed-duplex {1000full | 100full | 100half | 10full | 10half}

no speed-duplex

1000full - Forces 1000 Mbps full-duplex operation

100full - Forces 100 Mbps full-duplex operation

100half - Forces 100 Mbps half-duplex operation

10full - Forces 10 Mbps full-duplex operation

10half - Forces 10 Mbps half-duplex operation

DEFAULT SETTING

- ◆ Auto-negotiation is enabled by default.
- ◆ When auto-negotiation is disabled, the default speed-duplex setting is 100full for 1000BASE-T ports.

COMMAND MODE

Interface Configuration (Ethernet, Port Channel)

COMMAND USAGE

- ◆ The 1000BASE-T standard does not support forced mode. Auto-negotiation should always be used to establish a connection over any 1000BASE-T port or trunk. If not used, the success of the link process cannot be guaranteed when connecting to other types of switches.
- ◆ To force operation to the speed and duplex mode specified in a **speed-duplex** command, use the **no negotiation** command to disable auto-negotiation on the selected interface.
- ◆ When using the **negotiation** command to enable auto-negotiation, the optimal settings will be determined by the **capabilities** command. To set the speed/duplex mode under auto-negotiation, the required mode must be specified in the capabilities list for an interface.

EXAMPLE

The following example configures port 5 to 100 Mbps, half-duplex operation.

```
Console(config)#interface ethernet 1/5
Console(config-if)#speed-duplex 100half
Console(config-if)#no negotiation
Console(config-if)#
```

RELATED COMMANDS

[negotiation \(1001\)](#)

[capabilities \(997\)](#)

clear counters This command clears statistics on an interface.

SYNTAX

clear counters *interface*

interface

ethernet *unit/port*

unit - Unit identifier. (Range: 1)

port - Port number. (Range: 1-28/52)

port-channel *channel-id* (Range: 1-16)

DEFAULT SETTING

None

COMMAND MODE

Privileged Exec

COMMAND USAGE

Statistics are only initialized for a power reset. This command sets the base value for displayed statistics to zero for the current management session. However, if you log out and back into the management interface, the statistics displayed will show the absolute value accumulated since the last power reset.

EXAMPLE

The following example clears statistics on port 5.

```
Console#clear counters ethernet 1/5
Console#
```

show discard This command displays whether or not CDP and PVST packets are being discarded.

COMMAND MODE

Privileged Exec

EXAMPLE

In this example, "Default" means that the packets are not discarded.

```
Console#show discard
Port      CDP      PVST
-----  -
Eth 1/ 1  Default Default
Eth 1/ 2  Default Default
Eth 1/ 3  Default Default
Eth 1/ 4  Default Default
Eth 1/ 5  Default Default
Eth 1/ 6  Default Default
```

:

show interfaces brief This command displays a summary of key information, including operational status, native VLAN ID, default priority, speed/duplex mode, and port type for all ports.

COMMAND MODE

Privileged Exec

EXAMPLE

```

Console#show interfaces brief
Interface Name          Status   PVID Pri Speed/Duplex  Type          Trunk
-----
Eth 1/ 1                Down     1   0 Auto        1000BASE-T    None
Eth 1/ 2                Down     1   0 Auto        1000BASE-T    None
Eth 1/ 3                Down     1   0 Auto        1000BASE-T    None
Eth 1/ 4                Down     1   0 Auto        1000BASE-T    None
Eth 1/ 5                Down     1   0 Auto        1000BASE-T    None
Eth 1/ 6                Down     1   0 Auto        1000BASE-T    None
:

```

show interfaces counters This command displays interface statistics.

SYNTAX**show interfaces counters** [*interface*]*interface***ethernet** *unit/port**unit* - Unit identifier. (Range: 1)*port* - Port number. (Range: 1-28/52)**port-channel** *channel-id* (Range: 1-16)**DEFAULT SETTING**

Shows the counters for all interfaces.

COMMAND MODE

Normal Exec, Privileged Exec

COMMAND USAGE

If no interface is specified, information on all interfaces is displayed. For a description of the items displayed by this command, see ["Showing Port or Trunk Statistics" on page 166](#).

EXAMPLE

```
Console#show interfaces counters ethernet 1/17
Ethernet 1/ 17
===== IF table Stats =====
          2166458 Octets Input
        14734059 Octets Output
          14707 Unicast Input
          19806 Unicast Output
              0 Discard Input
              0 Discard Output
              0 Error Input
              0 Error Output
              0 Unknown Protocols Input
              0 QLen Output
===== Extended Iftable Stats =====
          23 Multi-cast Input
        5525 Multi-cast Output
          170 Broadcast Input
           11 Broadcast Output
===== Ether-like Stats =====
              0 Alignment Errors
              0 FCS Errors
              0 Single Collision Frames
              0 Multiple Collision Frames
              0 SQE Test Errors
              0 Deferred Transmissions
              0 Late Collisions
              0 Excessive Collisions
              0 Internal Mac Transmit Errors
              0 Internal Mac Receive Errors
              0 Frames Too Long
              0 Carrier Sense Errors
              0 Symbol Errors
===== RMON Stats =====
              0 Drop Events
        16900558 Octets
          40243 Packets
            170 Broadcast PKTS
             23 Multi-cast PKTS
              0 Undersize PKTS
              0 Oversize PKTS
              0 Fragments
              0 Jabbers
              0 CRC Align Errors
              0 Collisions
          21065 Packet Size <= 64 Octets
           3805 Packet Size 65 to 127 Octets
           2448 Packet Size 128 to 255 Octets
            797 Packet Size 256 to 511 Octets
           2941 Packet Size 512 to 1023 Octets
           9187 Packet Size 1024 to 1518 Octets
===== Port Utilization (recent 300 seconds) =====
              0 Octets input per second
              0 Packets input per second
              0.00 % Input utilization
              0 Octets output per second
              0 Packets output per second
              0.00 % Output utilization

Console#
```

show interfaces status This command displays the status for an interface.

SYNTAX

```
show interfaces status [interface]
    interface
        ethernet unit/port
            unit - Unit identifier. (Range: 1)
            port - Port number. (Range: 1-28/52)
        port-channel channel-id (Range: 1-16)
        vlan vlan-id (Range: 1-4094)
```

DEFAULT SETTING

Shows the status for all interfaces.

COMMAND MODE

Normal Exec, Privileged Exec

COMMAND USAGE

If no interface is specified, information on all interfaces is displayed. For a description of the items displayed by this command, see ["Displaying Connection Status" on page 159](#).

EXAMPLE

```
Console#show interfaces status ethernet 1/21
Information of Eth 1/21
  Port Type           : 1000BASE-T
  MAC Address         : B4-0E-DC-34-E6-3D
Configuration:
  Name                :
  Port Admin          : Up
  Speed-Duplex        : Auto
  Capabilities        : 10half, 10full, 100half, 100full, 1000full
  Broadcast Storm     : Enabled
  Broadcast Storm Limit : 500 packets/second
  Multicast Storm     : Disabled
  Multicast Storm Limit : 500 packets/second
  Unknown Unicast Storm : Disabled
  Unknown Unicast Storm Limit : 500 packets/second
  Flow Control         : Disabled
  VLAN Trunking       : Disabled
  LACP                 : Disabled
  MAC Learning        : Enabled
  Media Type          : None
Current Status:
  Link Status         : Up
  Port Operation Status : Up
  Operation Speed-duplex : 100full
  Up Time             : 0w 0d 1h 15m 6s (4506 seconds)
  Flow Control Type   : None
  Max Frame Size      : 1518 bytes (1522 bytes for tagged frames)
  MAC Learning Status : Enabled
Console#
```

show interfaces switchport This command displays the administrative and operational status of the specified interfaces.

SYNTAX

show interfaces switchport [*interface*]

interface

ethernet *unit/port*

unit - Unit identifier. (Range: 1)

port - Port number. (Range: 1-28/52)

port-channel *channel-id* (Range: 1-16)

DEFAULT SETTING

Shows all interfaces.

COMMAND MODE

Normal Exec, Privileged Exec

COMMAND USAGE

If no interface is specified, information on all interfaces is displayed.

EXAMPLE

This example shows the configuration setting for port 21.

```
Console#show interfaces switchport ethernet 1/21
Information of Eth 1/21
Broadcast Threshold           : Enabled, 500 packets/second
Multicast Threshold           : Disabled
Unknown Unicast Threshold    : Disabled
LACP Status                   : Disabled
Ingress Rate Limit            : Disabled, 1000M bits per second
Egress Rate Limit             : Disabled, 1000M bits per second
VLAN Membership Mode         : Hybrid
Ingress Rule                  : Disabled
Acceptable Frame Type        : All frames
Native VLAN                   : 1
Priority for Untagged Traffic : 0
GVRP Status                   : Disabled
Allowed VLAN                  : 1(u)
Forbidden VLAN                :
802.1Q Tunnel Status         : Disabled
802.1Q Tunnel Mode           : Normal
802.1Q Tunnel TPID           : 8100 (Hex)
Layer 2 Protocol Tunnel      : None
Console#
```

Table 114: show interfaces switchport - display description

Field	Description
Broadcast Threshold	Shows if broadcast storm suppression is enabled or disabled; if enabled it also shows the threshold level (page 1057).
Multicast Threshold	Shows if multicast storm suppression is enabled or disabled; if enabled it also shows the threshold level (page 1057).
Unknown Unicast Threshold	Shows if unknown unicast storm suppression is enabled or disabled; if enabled it also shows the threshold level (page 1057).
LACP Status	Shows if Link Aggregation Control Protocol has been enabled or disabled (page 1024).
Ingress/Egress Rate Limit	Shows if rate limiting is enabled, and the current rate limit (page 783).
VLAN Membership Mode	Indicates membership mode as Trunk or Hybrid (page 1161).
Ingress Rule	Shows if ingress filtering is enabled or disabled (page 1160).
Acceptable Frame Type	Shows if acceptable VLAN frames include all types or tagged frames only (page 1158).
Native VLAN	Indicates the default Port VLAN ID (page 1161).
Priority for Untagged Traffic	Indicates the default priority for untagged frames (page 1198).
GVRP Status	Shows if GARP VLAN Registration Protocol is enabled or disabled (page 1152).
Allowed VLAN	Shows the VLANs this interface has joined, where "(u)" indicates untagged and "(t)" indicates tagged (page 1159).
Forbidden VLAN	Shows the VLANs this interface can not dynamically join via GVRP (page 1152).
802.1Q Tunnel Status	Shows if 802.1Q tunnel is enabled on this interface (page 1166).
802.1Q Tunnel Mode	Shows the tunnel mode as Normal, 802.1Q Tunnel or 802.1Q Tunnel Uplink (page 1167).
802.1Q Tunnel TPID	Shows the Tag Protocol Identifier used for learning and switching packets (page 1170).
Layer 2 Protocol Tunnel	Shows if L2 Protocol Tunnel is enabled for spanning tree protocol (page 1175).

Transceiver Threshold Configuration

transceiver-monitor This command sends a trap when any of the transceiver's operational values fall outside of specified thresholds. Use the **no** form to disable trap messages.

SYNTAX

transceiver-monitor

DEFAULT SETTING

Disabled

COMMAND MODE

Interface Configuration (SFP Ports)

EXAMPLE

```
Console(config)interface ethernet 1/52
Console(config-if)#transceiver-monitor
Console#
```

transceiver-threshold-auto This command uses default threshold settings obtained from the transceiver to determine when an alarm or warning message should be sent. Use the **no** form to disable this feature.

SYNTAX

transceiver-threshold-auto

DEFAULT SETTING

Disabled

COMMAND MODE

Interface Configuration (SFP Ports)

EXAMPLE

```
Console(config)interface ethernet 1/52
Console(config-if)#transceiver-threshold-auto
Console#
```

transceiver-threshold current This command sets thresholds for transceiver current which can be used to trigger an alarm or warning message.

SYNTAX

transceiver-threshold current {high-alarm | high-warning | low-alarm | low-warning} *threshold-value*

high-alarm – Sets the high current threshold for an alarm message.

high-warning – Sets the high current threshold for a warning message.

low-alarm – Sets the low current threshold for an alarm message.

low-warning – Sets the low current threshold for a warning message.

threshold-value – The threshold of the transceiver current.
(Range: 0-13100 in units of 0.01 mA)

DEFAULT SETTING

High Alarm: 100 mA
High Warning: 90 mA
Low Warning: 7 mA
Low Alarm: 6 mA

COMMAND MODE

Interface Configuration (SFP Ports)

COMMAND USAGE

- ◆ If trap messages are enabled with the [transceiver-monitor](#) command, and a high-threshold alarm or warning message is sent if the current value is greater than or equal to the threshold, and the last sample value was less than the threshold. After a rising event has been generated, another such event will not be generated until the sampled value has fallen below the high threshold and reaches the low threshold.
- ◆ If trap messages are enabled with the [transceiver-monitor](#) command, and a low-threshold alarm or warning message is sent if the current value is less than or equal to the threshold, and the last sample value was greater than the threshold. After a falling event has been generated, another such event will not be generated until the sampled value has risen above the low threshold and reaches the high threshold.
- ◆ Threshold events are triggered as described above to avoid a hysteresis effect which would continuously trigger event messages if the power level were to fluctuate just above and below either the high threshold or the low threshold.
- ◆ Trap messages enabled by the [transceiver-monitor](#) command are sent to any management station configured by the [snmp-server host](#) command.

EXAMPLE

The following example sets alarm thresholds for the transceiver current at port 1.

```

Console(config)interface ethernet 1/52
Console(config-if)#transceiver-threshold current low-alarm 100
Console(config-if)#transceiver-threshold rx-power high-alarm 700
Console#

```

transceiver-threshold rx-power

This command sets thresholds for the transceiver power level of the received signal which can be used to trigger an alarm or warning message.

SYNTAX

transceiver-threshold rx-power {**high-alarm** | **high-warning** | **low-alarm** | **low-warning**} *threshold-value*

high-alarm – Sets the high power threshold for an alarm message.

high-warning – Sets the high power threshold for a warning message.

low-alarm – Sets the low power threshold for an alarm message.

low-warning – Sets the low power threshold for a warning message.

threshold-value – The power threshold of the received signal.
(Range: -4000 - 820 in units of 0.01 dBm)

DEFAULT SETTING

High Alarm: -3.00 dBm
High Warning: -3.50 dBm
Low Warning: -21.00 dBm
Low Alarm: -21.50 dBm

COMMAND MODE

Interface Configuration (SFP Ports)

COMMAND USAGE

- ◆ The threshold value is the power ratio in decibels (dB) of the measured power referenced to one milliwatt (mW).
- ◆ Refer to the Command Usage section under the [transceiver-threshold current](#) command for more information on configuring transceiver thresholds.
- ◆ Trap messages enabled by the [transceiver-monitor](#) command are sent to any management station configured by the [snmp-server host](#) command.

EXAMPLE

The following example sets alarm thresholds for the signal power received at port 1.

```
Console(config)interface ethernet 1/52
Console(config-if)#transceiver-threshold rx-power low-alarm -21
Console(config-if)#transceiver-threshold rx-power high-alarm -3
Console#
```

transceiver-threshold temperature

This command sets thresholds for the transceiver temperature which can be used to trigger an alarm or warning message.

SYNTAX

transceiver-threshold temperature {**high-alarm** | **high-warning** | **low-alarm** | **low-warning**} *threshold-value*

high-alarm – Sets the high temperature threshold for an alarm message.

high-warning – Sets the high temperature threshold for a warning message.

low-alarm – Sets the low temperature threshold for an alarm message.

low-warning – Sets the low temperature threshold for a warning message.

threshold-value – The threshold of the transceiver temperature.
(Range: -12800 - 12800 in units of 0.01 Celsius)

DEFAULT SETTING

High Alarm: 75.00 °C
High Warning: 70.00 °C
Low Alarm: -123.00 °C
Low Warning: 0.00 °C

COMMAND MODE

Interface Configuration (SFP Ports)

COMMAND USAGE

- ◆ Refer to the Command Usage section under the [transceiver-threshold current](#) command for more information on configuring transceiver thresholds.
- ◆ Trap messages enabled by the [transceiver-monitor](#) command are sent to any management station configured by the [snmp-server host](#) command.

EXAMPLE

The following example sets alarm thresholds for the transceiver temperature at port 1.

```
Console(config)interface ethernet 1/52
Console(config-if)#transceiver-threshold temperature low-alarm 97
Console(config-if)#transceiver-threshold temperature high-alarm -83
Console#
```

transceiver-threshold tx-power

This command sets thresholds for the transceiver power level of the transmitted signal which can be used to trigger an alarm or warning message.

SYNTAX

transceiver-threshold tx-power {**high-alarm** | **high-warning** | **low-alarm** | **low-warning**} *threshold-value*

high-alarm – Sets the high power threshold for an alarm message.

high-warning – Sets the high power threshold for a warning message.

low-alarm – Sets the low power threshold for an alarm message.

low-warning – Sets the low power threshold for a warning message.

threshold-value – The power threshold of the transmitted signal.
(Range: -4000 - 820 in units of 0.01 dBm)

DEFAULT SETTING

High Alarm: -9.00 dBm
High Warning: -9.50 dBm
Low Warning: -21.00 dBm
Low Alarm: -21.50 dBm

COMMAND MODE

Interface Configuration (SFP Ports)

COMMAND USAGE

- ◆ The threshold value is the power ratio in decibels (dB) of the measured power referenced to one milliwatt (mW).
- ◆ Refer to the Command Usage section under the [transceiver-threshold current](#) command for more information on configuring transceiver thresholds.
- ◆ Trap messages enabled by the [transceiver-monitor](#) command are sent to any management station configured by the [snmp-server host](#) command.

EXAMPLE

The following example sets alarm thresholds for the signal power transmitted at port 1.

```
Console(config)interface ethernet 1/52
Console(config-if)#transceiver-threshold tx-power low-alarm 8
Console(config-if)#transceiver-threshold tx-power high-alarm -3
Console#
```

transceiver-threshold voltage This command sets thresholds for the transceiver voltage which can be used to trigger an alarm or warning message.

SYNTAX

transceiver-threshold voltage {**high-alarm** | **high-warning** | **low-alarm** | **low-warning**} *threshold-value*

high-alarm – Sets the high voltage threshold for an alarm message.

high-warning – Sets the high voltage threshold for a warning message.

low-alarm – Sets the low voltage threshold for an alarm message.

low-warning – Sets the low voltage threshold for a warning message.

threshold-value – The threshold of the transceiver voltage.
(Range: 0-655 in units of 0.01 Volt)

DEFAULT SETTING

High Alarm: 3.50 Volts
 High Warning: 3.45 Volts
 Low Warning: 3.15 Volts
 Low Alarm: 3.10 Volts

COMMAND MODE

Interface Configuration (SFP Ports)

COMMAND USAGE

- ◆ Refer to the Command Usage section under the [transceiver-threshold current](#) command for more information on configuring transceiver thresholds.
- ◆ Trap messages enabled by the [transceiver-monitor](#) command are sent to any management station configured by the [snmp-server host](#) command.

EXAMPLE

The following example sets alarm thresholds for the transceiver voltage at port 1.

```
Console(config)interface ethernet 1/52
Console(config-if)#transceiver-threshold voltage low-alarm 4
Console(config-if)#transceiver-threshold voltage high-alarm 2
Console#
```

**show interfaces
transceiver**

This command displays identifying information for the specified transceiver, including connector type and vendor-related parameters, as well as the temperature, voltage, bias current, transmit power, and receive power.

SYNTAX

show interfaces transceiver [*interface*]

interface

ethernet *unit/port*

unit - Unit identifier. (Range: 1)

port - Port number. (Range: 25-28/49-52)

DEFAULT SETTING

Shows all SFP interfaces.

COMMAND MODE

Privileged Exec

COMMAND USAGE

The switch can display diagnostic information for SFP modules which support the SFF-8472 Specification for Diagnostic Monitoring Interface for Optical Transceivers. This information allows administrators to remotely

diagnose problems with optical devices. This feature, referred to as Digital Diagnostic Monitoring (DDM) in the command display, provides information on transceiver parameters including temperature, supply voltage, laser bias current, laser power, received optical power, and related alarm thresholds.

EXAMPLE

```

Console#show interfaces transceiver ethernet 1/52
Information of Eth 1/52
Connector Type      : LC
Fiber Type         : Multimode 50um (M5), Multimode 62.5um (M6)
Eth Compliance Codes : 1000BASE-SX
Baud Rate          : 1300 MBd
Vendor OUI         : 00-00-00
Vendor Name        : SMC Networks
Vendor PN          : SMC1GSFP-SX
Vendor Rev         : V1.1
Vendor SN          : A492101711
Date Code          : 09-05-19
DDM Information
  Temperature       : 35.64 degree C
  Vcc               : 3.25 V
  Bias Current      : 12.13 mA
  TX Power          : 2.36 dBm
  RX Power          : -24.20 dBm
DDM Thresholds
-----
                Low Alarm  Low Warning  High Warning  High Alarm
-----
Temperature(Celsius)  -45.00      -40.00          85.00        90.00
Voltage(Volts)        2.90         3.00           3.60         3.70
Current(mA)           1.00         3.00           50.00        60.00
TxPower(dBm)         -11.50       -10.50          -2.00        -1.00
RxPower(dBm)         -23.98       -23.01          -1.00         0.00
Console#

```

show interfaces transceiver-threshold This command Displays the alarm/warning thresholds for temperature, voltage, bias current, transmit power, and receive power. **SYNTAX**

SYNTAX

show interfaces transceiver-threshold [*interface*]

interface

ethernet *unit/port*

unit - Unit identifier. (Range: 1)

port - Port number. (Range: 25-28/49-52)

DEFAULT SETTING

Shows all SFP interfaces.

COMMAND MODE

Privileged Exec

COMMAND USAGE

- ◆ The switch can display diagnostic information for SFP modules which support the SFF-8472 Specification for Diagnostic Monitoring Interface for Optical Transceivers. This information allows administrators to remotely diagnose problems with optical devices. This feature, referred to as Digital Diagnostic Monitoring (DDM) in the command display, provides information on transceiver parameters including temperature, supply voltage, laser bias current, laser power, received optical power, and related alarm thresholds.
- ◆ The DDM thresholds displayed by this command only apply to ports which have a DDM-compliant transceiver inserted.

EXAMPLE

```

Console#show interfaces transceiver-threshold ethernet 1/52
Information of Eth 1/52
DDM Thresholds
Transceiver-monitor      : Disabled
Transceiver-threshold-auto : Enabled
-----
          Low Alarm  Low Warning  High Warning  High Alarm
-----
Temperature(Celsius)    -123.00      0.00         70.00        75.00
Voltage(Volts)          3.10         3.15         3.45         3.50
Current(mA)              6.00         7.00         90.00        100.00
TxPower(dBm)            -12.00      -11.50       -9.50        -9.00
RxPower(dBm)            -21.50      -21.00       -3.50        -3.00
-----
Console#

```

Cable Diagnostics

test cable-diagnostics This command performs cable diagnostics on the specified port to diagnose any cable faults (short, open, etc.) and report the cable length.

SYNTAX

test cable-diagnostics interface *interface*

interface

ethernet *unit/port*

unit - Unit identifier. (Range: 1)

port - Port number. (Range: 1-24/48)

COMMAND MODE

Privileged Exec

COMMAND USAGE

- ◆ Cable diagnostics are performed using Digital Signal Processing (DSP) test methods. DSP analyses the cable by sending a pulsed signal into the cable, and then examining the reflection of that pulse.

- ◆ This cable test is only accurate for Gigabit Ethernet cables 7 - 100 meters long.
- ◆ The test takes approximately 5 seconds. The switch displays the results of the test immediately upon completion, including common cable failures, as well as the status and approximate length of each cable pair.
- ◆ Potential conditions which may be listed by the diagnostics include:
 - OK: Correctly terminated pair
 - Open: Open pair, no link partner
 - Short: Shorted pair
 - Not Supported: This message is displayed for Gigabit Ethernet ports linked up at a speed lower than 1000 Mbps.
 - Impedance mismatch: Terminating impedance is not in the reference range.
- ◆ Ports are linked down while running cable diagnostics.
- ◆ To ensure more accurate measurement of the length to a fault, first disable power-saving mode (using the `no power-save` command) on the link partner before running cable diagnostics.

EXAMPLE

```
Console#test cable-diagnostics interface ethernet 1/23
Console#show cable-diagnostics interface ethernet 1/23
TF: Test failed
OK: OK
ON: Open
ST: Short
IE: Impedance error
NC: No cable
NT: Not tested
NS: Not supported
UN: Unknown
Port      Type Link      Pair A   Pair B   Pair C   Pair D   Last
          Status meters meters meters meters Updated
-----
Eth 1/ 1 GE Up        OK (0)  OK (0)  NS       NS       2014-05-08 12:12:50
Console#
```

show cable-diagnostics This command shows the results of a cable diagnostics test.

SYNTAX

show cable-diagnostics interface [*interface*]

interface

ethernet *unit/port*

unit - Unit identifier. (Range: 1)

port - Port number. (Range: 1-24/48)

COMMAND MODE

Privileged Exec

COMMAND USAGE

- ◆ The results include common cable failures, as well as the status and approximate distance to a fault, or the approximate cable length if no fault is found.
- ◆ To ensure more accurate measurement of the length to a fault, first disable power-saving mode on the link partner before running cable diagnostics.
- ◆ For link-down ports, the reported distance to a fault is accurate to within +/- 2 meters. For link-up ports, the accuracy is +/- 10 meters.

EXAMPLE

```

Console#show cable-diagnostics interface ethernet 1/23
Port      Type Link Status Pair A (meters)  Pair B (meters)  Last Updated
-----
Eth 1/23  GE  Up      OK (21)          OK (21)          2009-11-13 09:44:19
Console#

```

Power Savings

power-save This command enables power savings mode on the specified port.

SYNTAX

[no] **power-save**

COMMAND MODE

Interface Configuration (Ethernet, Ports 1-24/48)

COMMAND USAGE

- ◆ IEEE 802.3 defines the Ethernet standard and subsequent power requirements based on cable connections operating at 100 meters. Enabling power saving mode can reduce power used for cable lengths of 60 meters or less, with more significant reduction for cables of 20 meters or less, and continue to ensure signal integrity.
- ◆ Power saving mode only applies to the Gigabit Ethernet ports using copper media.
- ◆ Power savings can be enabled on Gigabit Ethernet RJ-45 ports.
- ◆ The power-saving methods provided by this switch include:
 - Power saving when there is no link partner:

Under normal operation, the switch continuously auto-negotiates to find a link partner, keeping the MAC interface powered up even if no link connection exists. When using power-savings mode, the switch

checks for energy on the circuit to determine if there is a link partner. If none is detected, the switch automatically turns off the transmitter, and most of the receive circuitry (entering Sleep Mode). In this mode, the low-power energy-detection circuit continuously checks for energy on the cable. If none is detected, the MAC interface is also powered down to save additional energy. If energy is detected, the switch immediately turns on both the transmitter and receiver functions, and powers up the MAC interface.

- Power saving when there is a link partner:

Traditional Ethernet connections typically operate with enough power to support at least 100 meters of cable even though average network cable length is shorter. When cable length is shorter, power consumption can be reduced since signal attenuation is proportional to cable length. When power-savings mode is enabled, the switch analyzes cable length to determine whether or not it can reduce the signal amplitude used on a particular link.



NOTE: Power savings can only be implemented on Gigabit Ethernet ports using twisted-pair cabling. Power-savings mode on a active link only works when connection speed is 1 Gbps, and line length is less than 60 meters.

EXAMPLE

```
Console(config)#interface ethernet 1/1
Console(config-if)#power-save
Console(config-if)#
```

show power-save This command shows the configuration settings for power savings.

SYNTAX

show power-save [**interface** *interface*]

interface

ethernet *unit/port*

unit - Unit identifier. (Range: 1)

port - Port number. (Range: 1-24/48)

COMMAND MODE

Privileged Exec

EXAMPLE

```
Console#show power-save interface ethernet 1/1
Power Saving Status:
 Ethernet 1/1 : Enabled
Console#
```

Ports can be statically grouped into an aggregate link (i.e., trunk) to increase the bandwidth of a network connection or to ensure fault recovery. Or you can use the Link Aggregation Control Protocol (LACP) to automatically negotiate a trunk link between this switch and another network device. For static trunks, the switches have to comply with the Cisco EtherChannel standard. For dynamic trunks, the switches have to comply with LACP. This switch supports up to 16 trunks. For example, a trunk consisting of two 1000 Mbps ports can support an aggregate bandwidth of 4 Gbps when operating at full duplex.

Table 115: Link Aggregation Commands

Command	Function	Mode
<i>Manual Configuration Commands</i>		
<code>interface port-channel</code>	Configures a trunk and enters interface configuration mode for the trunk	GC
<code>port channel load-balance</code>	Sets the load-distribution method among ports in aggregated links	GC
<code>channel-group</code>	Adds a port to a trunk	IC (Ethernet)
<i>Dynamic Configuration Commands</i>		
<code>lacp</code>	Configures LACP for the current interface	IC (Ethernet)
<code>lacp admin-key</code>	Configures a port's administration key	IC (Ethernet)
<code>lacp port-priority</code>	Configures a port's LACP port priority	IC (Ethernet)
<code>lacp system-priority</code>	Configures a port's LACP system priority	IC (Ethernet)
<code>lacp admin-key</code>	Configures an port channel's administration key	IC (Port Channel)
<code>lacp timeout</code>	Configures the timeout to wait for next LACPDU	IC (Port Channel)
<i>Trunk Status Display Commands</i>		
<code>show interfaces status port-channel</code>	Shows trunk information	NE, PE
<code>show lacp</code>	Shows LACP information	PE
<code>show port-channel load-balance</code>	Shows the load-distribution method used on aggregated links	PE

GUIDELINES FOR CREATING TRUNKS

General Guidelines –

- ◆ Finish configuring trunks before you connect the corresponding network cables between switches to avoid creating a loop.
- ◆ A trunk can have up to 8 ports.
- ◆ The ports at both ends of a connection must be configured as trunk ports.

- ◆ All ports in a trunk must be configured in an identical manner, including communication mode (i.e., speed and duplex mode), VLAN assignments, and CoS settings.
- ◆ Any of the Gigabit ports on the front panel can be trunked together, including ports of different media types.
- ◆ All the ports in a trunk have to be treated as a whole when moved from/to, added or deleted from a VLAN via the specified port-channel.
- ◆ STP, VLAN, and IGMP settings can only be made for the entire trunk via the specified port-channel.

Dynamically Creating a Port Channel –

Ports assigned to a common port channel must meet the following criteria:

- ◆ Ports must have the same LACP system priority.
- ◆ Ports must have the same port admin key (Ethernet Interface).
- ◆ If the port channel admin key ([lACP admin key](#) - Port Channel) is not set when a channel group is formed (i.e., it has the null value of 0), this key is set to the same value as the port admin key ([lACP admin key](#) - Ethernet Interface) used by the interfaces that joined the group.
- ◆ However, if the port channel admin key is set, then the port admin key must be set to the same value for a port to be allowed to join a channel group.
- ◆ If a link goes down, LACP port priority is used to select the backup link.

Manual Configuration Commands

port channel load-balance This command sets the load-distribution method among ports in aggregated links (for both static and dynamic trunks). Use the **no** form to restore the default setting.

SYNTAX

port channel load-balance {dst-ip | dst-mac | src-dst-ip | src-dst-mac | src-ip | src-mac}

no port channel load-balance

dst-ip - Load balancing based on destination IP address.

dst-mac - Load balancing based on destination MAC address.

src-dst-ip - Load balancing based on source and destination IP address.

src-dst-mac - Load balancing based on source and destination MAC address.

src-ip - Load balancing based on source IP address.

src-mac - Load balancing based on source MAC address.

DEFAULT SETTING

src-dst-mac

COMMAND MODE

Global Configuration

COMMAND USAGE

- ◆ This command applies to all static and dynamic trunks on the switch.
- ◆ To ensure that the switch traffic load is distributed evenly across all links in a trunk, select the source and destination addresses used in the load-balance calculation to provide the best result for trunk connections:
 - **dst-ip:** All traffic with the same destination IP address is output on the same link in a trunk. This mode works best for switch-to-router trunk links where traffic through the switch is destined for many different hosts. Do not use this mode for switch-to-server trunk links where the destination IP address is the same for all traffic.
 - **dst-mac:** All traffic with the same destination MAC address is output on the same link in a trunk. This mode works best for switch-to-switch trunk links where traffic through the switch is destined for many different hosts. Do not use this mode for switch-to-router trunk links where the destination MAC address is the same for all traffic.
 - **src-dst-ip:** All traffic with the same source and destination IP address is output on the same link in a trunk. This mode works best for switch-to-router trunk links where traffic through the switch is received from and destined for many different hosts.
 - **src-dst-mac:** All traffic with the same source and destination MAC address is output on the same link in a trunk. This mode works best for switch-to-switch trunk links where traffic through the switch is received from and destined for many different hosts.
 - **src-ip:** All traffic with the same source IP address is output on the same link in a trunk. This mode works best for switch-to-router or switch-to-server trunk links where traffic through the switch is received from many different hosts.
 - **src-mac:** All traffic with the same source MAC address is output on the same link in a trunk. This mode works best for switch-to-switch trunk links where traffic through the switch is received from many different hosts.

EXAMPLE

```
Console(config)#port-channel load-balance dst-ip
Console(config)#
```

channel-group This command adds a port to a trunk. Use the **no** form to remove a port from a trunk.

SYNTAX

channel-group *channel-id*

no channel-group

channel-id - Trunk index (Range: 1-16)

DEFAULT SETTING

The current port will be added to this trunk.

COMMAND MODE

Interface Configuration (Ethernet)

COMMAND USAGE

- ◆ When configuring static trunks, the switches must comply with the Cisco EtherChannel standard.
- ◆ Use **no channel-group** to remove a port group from a trunk.
- ◆ Use **no interface port-channel** to remove a trunk from the switch.

EXAMPLE

The following example creates trunk 1 and then adds port 10:

```
Console(config)#interface port-channel 1
Console(config-if)#exit
Console(config)#interface ethernet 1/10
Console(config-if)#channel-group 1
Console(config-if)#
```

Dynamic Configuration Commands

lACP This command enables 802.3ad Link Aggregation Control Protocol (LACP) for the current interface. Use the **no** form to disable it.

SYNTAX

[no] lACP

DEFAULT SETTING

Disabled

COMMAND MODE

Interface Configuration (Ethernet)

COMMAND USAGE

- ◆ The ports on both ends of an LACP trunk must be configured for full duplex, either by forced mode or auto-negotiation.

- ◆ A trunk formed with another switch using LACP will automatically be assigned the next available port-channel ID.
- ◆ If the target switch has also enabled LACP on the connected ports, the trunk will be activated automatically.
- ◆ If more than eight ports attached to the same target switch have LACP enabled, the additional ports will be placed in standby mode, and will only be enabled if one of the active links fails.

EXAMPLE

The following shows LACP enabled on ports 10-12. Because LACP has also been enabled on the ports at the other end of the links, the [show interfaces status port-channel 1](#) command shows that Trunk1 has been established.

```

Console(config)#interface ethernet 1/10
Console(config-if)#lACP
Console(config-if)#interface ethernet 1/11
Console(config-if)#lACP
Console(config-if)#interface ethernet 1/12
Console(config-if)#lACP
Console(config-if)#end
Console#show interfaces status port-channel 1
Information of Trunk 1
Basic Information:
  Port Type           : 1000BASE-T
  MAC Address         : B4-0E-DC-34-96-12
Configuration:
  Name                :
  Port Admin          : Up
  Speed-Duplex        : Auto
  Capabilities        : 10half, 10full, 100half, 100full, 1000full
  Broadcast Storm     : Enabled
  Broadcast Storm Limit : 500 packets/second
  Multicast Storm     : Disabled
  Multicast Storm Limit : 500 packets/second
  Unknown Unicast Storm : Disabled
  Unknown Unicast Storm Limit : 500 packets/second
  Flow Control        : Disabled
  VLAN Trunking       : Disabled
  MAC Learning        : Enabled
Current Status:
  Created By          : LACP
  Link Status         : Up
  Port Operational Status: Up
  Operation Speed-Duplex : 1000full
  Up Time             : 0w 0d 0h 3m 47s (227 seconds)
  Flow Control Type   : None
  Max Frame Size      : 1518 bytes (1522 bytes for tagged frames)
  MAC Learning Status : Enabled
  Member Ports        : Eth1/13, Eth1/14
  Active Member Ports : Eth1/13, Eth1/14
Console#

```

lACP admin-key (Ethernet Interface) This command configures a port's LACP administration key. Use the **no** form to restore the default setting.

SYNTAX

lACP {**actor** | **partner**} **admin-key** *key*

no lACP {**actor** | **partner**} **admin-key**

actor - The local side an aggregate link.

partner - The remote side of an aggregate link.

key - The port admin key must be set to the same value for ports that belong to the same link aggregation group (LAG).
(Range: 0-65535)

DEFAULT SETTING

Actor: 1, Partner: 0

COMMAND MODE

Interface Configuration (Ethernet)

COMMAND USAGE

- ◆ Ports are only allowed to join the same LAG if (1) the LACP system priority matches, (2) the LACP port admin key matches, and (3) the LACP port channel key matches (if configured).
- ◆ If the port channel admin key (**lACP admin key** - Port Channel) is not set when a channel group is formed (i.e., it has the null value of 0), this key is set to the same value as the port admin key (**lACP admin key** - Ethernet Interface) used by the interfaces that joined the group.
- ◆ Once the remote side of a link has been established, LACP operational settings are already in use on that side. Configuring LACP settings for the partner only applies to its administrative state, not its operational state.
- ◆ By default, the actor's operational key is determined by port's link speed (1000f - 4, 100f - 3, 10f - 2), and copied to the admin key.

EXAMPLE

```
Console(config)#interface ethernet 1/5
Console(config-if)#lACP actor admin-key 120
Console(config-if)#
```

lACP port-priority This command configures LACP port priority. Use the **no** form to restore the default setting.

SYNTAX

lACP {**actor** | **partner**} **port-priority** *priority*

no lACP {**actor** | **partner**} **port-priority**

actor - The local side an aggregate link.

partner - The remote side of an aggregate link.

priority - LACP port priority is used to select a backup link.
(Range: 0-65535)

DEFAULT SETTING

32768

COMMAND MODE

Interface Configuration (Ethernet)

COMMAND USAGE

- ◆ Setting a lower value indicates a higher effective priority.
- ◆ If an active port link goes down, the backup port with the highest priority is selected to replace the downed link. However, if two or more ports have the same LACP port priority, the port with the lowest physical port number will be selected as the backup port.
- ◆ If an LAG already exists with the maximum number of allowed port members, and LACP is subsequently enabled on another port using a higher priority than an existing member, the newly configured port will replace an existing port member that has a lower priority.
- ◆ Once the remote side of a link has been established, LACP operational settings are already in use on that side. Configuring LACP settings for the partner only applies to its administrative state, not its operational state, and will only take effect the next time an aggregate link is established with the partner.

EXAMPLE

```
Console(config)#interface ethernet 1/5  
Console(config-if)#lACP actor port-priority 128
```

lacp system-priority This command configures a port's LACP system priority. Use the **no** form to restore the default setting.

SYNTAX

lacp {**actor** | **partner**} **system-priority** *priority*

no lacp {**actor** | **partner**} **system-priority**

actor - The local side an aggregate link.

partner - The remote side of an aggregate link.

priority - This priority is used to determine link aggregation group (LAG) membership, and to identify this device to other switches during LAG negotiations. (Range: 0-65535)

DEFAULT SETTING

32768

COMMAND MODE

Interface Configuration (Ethernet)

COMMAND USAGE

- ◆ Port must be configured with the same system priority to join the same LAG.
- ◆ System priority is combined with the switch's MAC address to form the LAG identifier. This identifier is used to indicate a specific LAG during LACP negotiations with other systems.
- ◆ Once the remote side of a link has been established, LACP operational settings are already in use on that side. Configuring LACP settings for the partner only applies to its administrative state, not its operational state, and will only take effect the next time an aggregate link is established with the partner.

EXAMPLE

```
Console(config)#interface ethernet 1/5
Console(config-if)#lacp actor system-priority 3
Console(config-if)#
```

lacp admin-key (Port Channel) This command configures a port channel's LACP administration key string. Use the **no** form to restore the default setting.

SYNTAX

lacp admin-key *key*

no lacp admin-key

key - The port channel admin key is used to identify a specific link aggregation group (LAG) during local LACP setup on this switch. (Range: 0-65535)

DEFAULT SETTING

0

COMMAND MODE

Interface Configuration (Port Channel)

COMMAND USAGE

- ◆ Ports are only allowed to join the same LAG if (1) the LACP system priority matches, (2) the LACP port admin key matches, and (3) the LACP port channel key matches (if configured).
- ◆ If the port channel admin key (**lACP admin key** - Port Channel) is not set when a channel group is formed (i.e., it has the null value of 0), this key is set to the same value as the port admin key (**lACP admin key** - Ethernet Interface) used by the interfaces that joined the group. Note that when the LAG is no longer used, the port channel admin key is reset to 0.
- ◆ If the port channel admin key is set to a non-default value, the operational key is based upon LACP PDUs received from the partner, and the channel admin key is reset to the default value. The trunk identifier will also be changed by this process.

EXAMPLE

```
Console(config)#interface port-channel 1
Console(config-if)#lACP admin-key 3
Console(config-if)#
```

lACP timeout This command configures the timeout to wait for the next LACP data unit (LACPDU). Use the no form to restore the default setting.

SYNTAX

lACP timeout {long | short}

no lACP timeout

long - Specifies a slow timeout of 90 seconds.

short - Specifies a fast timeout of 3 seconds.

DEFAULT SETTING

long

COMMAND MODE

Interface Configuration (Port Channel)

COMMAND USAGE

- ◆ The timeout configured by this command is set in the LACP timeout bit of the Actor State field in transmitted LACPDUs. When the partner switch receives an LACPDU set with a short timeout from the actor switch, the partner adjusts the transmit LACPDU interval to 1 second.

When it receives an LACPDU set with a long timeout from the actor, it adjusts the transmit LACPDU interval to 30 seconds.

- ◆ If the actor does not receive an LACPDU from its partner before the configured timeout expires, the partner port information will be deleted from the LACP group.
- ◆ When a dynamic port-channel member leaves a port-channel, the default timeout value will be restored on that port.
- ◆ When a dynamic port-channel is torn down, the configured timeout value will be retained. When the dynamic port-channel is constructed again, that timeout value will be used.

EXAMPLE

```
Console(config)#interface port-channel 1
Console(config-if)#lACP timeout short
Console(config-if)#
```

Trunk Status Display Commands

show lacp This command displays LACP information.

SYNTAX

show lacp [*port-channel*] {**counters** | **internal** | **neighbors** | **sys-id**}

port-channel - Local identifier for a link aggregation group.
(Range: 1-12)

counters - Statistics for LACP protocol messages.

internal - Configuration settings and operational state for local side.

neighbors - Configuration settings and operational state for remote side.

sys-id - Summary of system priority and MAC address for all channel groups.

DEFAULT SETTING

Port Channel: all

COMMAND MODE

Privileged Exec

EXAMPLE

```
Console#show lacp 1 counters
Port Channel: 1
-----
Eth 1/ 2
-----
```

```
LACPDUs Sent      : 12
LACPDUs Received  : 6
Marker Sent       : 0
Marker Received   : 0
LACPDUs Unknown Pkts : 0
LACPDUs Illegal Pkts : 0
:
```

Table 116: show lacp counters - display description

Field	Description
LACPDUs Sent	Number of valid LACPDUs transmitted from this channel group.
LACPDUs Received	Number of valid LACPDUs received on this channel group.
Marker Sent	Number of valid Marker PDUs transmitted from this channel group.
Marker Received	Number of valid Marker PDUs received by this channel group.
LACPDUs Unknown Pkts	Number of frames received that either (1) Carry the Slow Protocols Ethernet Type value, but contain an unknown PDU, or (2) are addressed to the Slow Protocols group MAC Address, but do not carry the Slow Protocols Ethernet Type.
LACPDUs Illegal Pkts	Number of frames that carry the Slow Protocols Ethernet Type value, but contain a badly formed PDU or an illegal value of Protocol Subtype.

```
Console#show lacp 1 internal
Port Channel : 1
-----
Oper Key   : 3
Admin Key  : 0
Timeout    : long

Eth 1/ 1
-----
LACPDUs Internal      : 30 seconds
LACP System Priority  : 32768
LACP Port Priority     : 32768
Admin Key              : 3
Oper Key               : 3
Admin State            : defaulted, aggregation, long timeout, LACP-activity
Oper State             : distributing, collecting, synchronization,
                       aggregation, long timeout, LACP-activity
:
```

Table 117: show lacp internal - display description

Field	Description
Oper Key	Current operational value of the key for the aggregation port.
Admin Key	Current administrative value of the key for the aggregation port.
LACPDUs Internal	Number of seconds before invalidating received LACPDU information.
LACP System Priority	LACP system priority assigned to this port channel.
LACP Port Priority	LACP port priority assigned to this interface within the channel group.

Table 117: show lacp internal - display description (Continued)

Field	Description
Admin State, Oper State	<p>Administrative or operational values of the actor's state parameters:</p> <ul style="list-style-type: none"> ◆ Expired – The actor's receive machine is in the expired state; ◆ Defaulted – The actor's receive machine is using defaulted operational partner information, administratively configured for the partner. ◆ Distributing – If false, distribution of outgoing frames on this link is disabled; i.e., distribution is currently disabled and is not expected to be enabled in the absence of administrative changes or changes in received protocol information. ◆ Collecting – Collection of incoming frames on this link is enabled; i.e., collection is currently enabled and is not expected to be disabled in the absence of administrative changes or changes in received protocol information. ◆ Synchronization – The System considers this link to be IN_SYNC; i.e., it has been allocated to the correct Link Aggregation Group, the group has been associated with a compatible Aggregator, and the identity of the Link Aggregation Group is consistent with the System ID and operational Key information transmitted. ◆ Aggregation – The system considers this link to be aggregatable; i.e., a potential candidate for aggregation. ◆ Long timeout – Periodic transmission of LACPDUs uses a slow transmission rate. ◆ LACP-Activity – Activity control value with regard to this link. (0: Passive; 1: Active)

```

Console#show lacp 1 neighbors
Port Channel 1 neighbors
-----
Eth 1/ 1
-----
Partner Admin System ID   : 32768, 00-00-00-00-00-00
Partner Oper System ID    : 32768, 00-12-CF-61-24-2F
Partner Admin Port Number : 1
Partner Oper Port Number  : 1
Port Admin Priority        : 32768
Port Oper Priority         : 32768
Admin Key                  : 0
Oper Key                   : 3
Admin State:               defaulted, distributing, collecting,
                           synchronization, long timeout,
Oper State:                distributing, collecting, synchronization,
                           aggregation, long timeout, LACP-activity
:

```

Table 118: show lacp neighbors - display description

Field	Description
Partner Admin System ID	LAG partner's system ID assigned by the user.
Partner Oper System ID	LAG partner's system ID assigned by the LACP protocol.
Partner Admin Port Number	Current administrative value of the port number for the protocol Partner.
Partner Oper Port Number	Operational port number assigned to this aggregation port by the port's protocol partner.
Port Admin Priority	Current administrative value of the port priority for the protocol partner.

Table 118: show lacp neighbors - display description (Continued)

Field	Description
Port Oper Priority	Priority value assigned to this aggregation port by the partner.
Admin Key	Current administrative value of the Key for the protocol partner.
Oper Key	Current operational value of the Key for the protocol partner.
Admin State	Administrative values of the partner's state parameters. (See preceding table.)
Oper State	Operational values of the partner's state parameters. (See preceding table.)

```

Console#show lacp sysid
Port Channel      System Priority    System MAC Address
-----
                1                32768             00-30-F1-8F-2C-A7
                2                32768             00-30-F1-8F-2C-A7
                3                32768             00-30-F1-8F-2C-A7
                4                32768             00-30-F1-8F-2C-A7
                5                32768             00-30-F1-8F-2C-A7
                6                32768             00-30-F1-8F-2C-A7
                7                32768             00-30-F1-D4-73-A0
                8                32768             00-30-F1-D4-73-A0
                9                32768             00-30-F1-D4-73-A0
               10                32768             00-30-F1-D4-73-A0
               11                32768             00-30-F1-D4-73-A0
               12                32768             00-30-F1-D4-73-A0
               :

```

Table 119: show lacp sysid - display description

Field	Description
Channel group	A link aggregation group configured on this switch.
System Priority*	LACP system priority for this channel group.
System MAC Address*	System MAC address.

* The LACP system priority and system MAC address are concatenated to form the LAG system ID.

show port-channel load-balance This command shows the load-distribution method used on aggregated links.

COMMAND MODE
Privileged Exec

EXAMPLE

```

Console#show port-channel load-balance
Trunk Load Balance Mode: Destination IP address
Console#

```

The commands in this group control the power that can be delivered to attached PoE devices through RJ-45 ports 1-24 on the ECS4110-28P and ports 1-48 on the ECS4110-52P.

The switch's power management enables total switch power and individual port power to be controlled within a configured power budget. Port power can be automatically turned on and off for connected devices, and a per-port power priority can be set so that the switch never exceeds its allocated power budget. When a device is connected to a switch port, its power requirements are detected by the switch before power is supplied. If the power required by a device exceeds the power budget of the port or the whole switch, power is not supplied.

Table 120: PoE Commands

Command	Function	Mode
<code>power inline compatible</code>	Provides power to pre-standard PoE devices	GC
<code>power mainpower maximum allocation</code>	Sets the maximum power available to all switch ports	GC
<code>power inline</code>	Turns power on and off for specific ports	IC
<code>power inline maximum allocation</code>	Sets the maximum power available to specific switch ports	IC
<code>power inline priority</code>	Sets the priority for power supplied to specific ports	IC
<code>power inline time-range</code>	Binds a time-range to a port during which PoE is supplied	IC
<code>show power inline status</code>	Displays the current status of power management on specific ports or all ports	PE
<code>show power inline time-range</code>	Shows the time-range and current status for specific ports or for all ports	PE
<code>show power mainpower</code>	Displays current status of power management for the switch	PE

power inline compatible This command allows the switch to detect and provide power to powered devices that were designed prior to the IEEE 802.3af PoE standard. Use the **no** form to disable this feature.

SYNTAX

[no] power inline compatible

DEFAULT SETTING

Enabled

COMMAND MODE

Global Configuration

COMMAND USAGE

- ◆ The switch automatically detects attached PoE devices by periodically transmitting test voltages that over the Gigabit Ethernet copper-media ports. When an IEEE 802.3af or 802.3at compatible device is plugged into one of these ports, the powered device reflects the test voltage back to the switch, which may then turn on the power to this device. When the **power inline compatible** command is used, this switch can detect IEEE 802.3af or 802.3at compliant devices and the more recent 802.3af non-compliant devices that also reflect the test voltages back to the switch. It cannot detect other legacy devices that do not reflect back the test voltages.
- ◆ For legacy devices to be supported by this switch, they must be able to accept power over the data pairs connected to the RJ-45 ports.

EXAMPLE

```

Console(config)#power inline compatible
Console(config)#end
Console#show power inline status
Unit: 1
Unit: 1
Compatible mode : Disabled

```

Interface	Admin	Time Range	Oper	Max Power	Used Power	Priority
Eth 1/ 1	Enabled	--	On	34200 mW	8200 mW	Low
Eth 1/ 2	Enabled	--	Off	34200 mW	0 mW	Low
Eth 1/ 3	Enabled	--	Off	34200 mW	0 mW	Low
Eth 1/ 4	Enabled	--	Off	34200 mW	0 mW	Low
Eth 1/ 5	Enabled	--	Off	34200 mW	0 mW	Low
Eth 1/ 6	Enabled	--	Off	34200 mW	0 mW	Low
Eth 1/ 7	Enabled	--	Off	34200 mW	0 mW	Low
Eth 1/ 8	Enabled	--	Off	34200 mW	0 mW	Low
Eth 1/ 9	Enabled	--	Off	34200 mW	0 mW	Low
Eth 1/10	Enabled	--	Off	34200 mW	0 mW	Low
Eth 1/11	Enabled	--	Off	34200 mW	0 mW	Low
Eth 1/12	Enabled	--	Off	34200 mW	0 mW	Low
:						

power mainpower maximum allocation

This command defines a power budget for the switch (i.e., the power available to all switch ports). Use the **no** form to restore the default setting.

SYNTAX

power mainpower maximum allocation *milliwatts*

milliwatts - The power budget for the switch.
 (ECS4110-28P: 50000-390000 milliwatts
 ECS4110-52P: 50000-400000 milliwatts)

DEFAULT SETTING

ECS4110-28P: 390000 milliwatts
 ECS4110-52P: 400000 milliwatts

COMMAND MODE

Global Configuration

COMMAND USAGE

- ◆ Setting a maximum power budget for the switch enables power to be centrally managed, preventing overload conditions at the power source.
- ◆ If the power demand from devices connected to the switch exceeds the power budget setting, the switch uses port power priority settings to limit the supplied power.

EXAMPLE

```
Console(config)#power mainpower maximum allocation 180
Console(config)#
```

RELATED COMMANDS

[power inline priority \(1039\)](#)

power inline This command instructs the switch to automatically detect if a PoE-compliant device is connected to the specified port, and turn power on or off accordingly. Use the **no** form to turn off power for a port, or the **no** form with the time-range keyword to remove the time range settings.

SYNTAX

power inline [**time-range** *time-range-name*]

no power inline [**time-range**]

time-range-name - Name of a time-range during which PoE is supplied to the attached device. (Range: 1-30 characters)

DEFAULT SETTING

Detection is enabled for PoE-compliant devices.

COMMAND MODE

Interface Configuration (Ethernet ports 1-24/48)

COMMAND USAGE

- ◆ The switch only provides power to the Gigabit Ethernet copper-media ports.
- ◆ When detection is enabled for PoE-compliant devices, power is automatically supplied when a device is detected on the port, providing that the power demanded does not exceed the port's power budget or the switch's power budget.

EXAMPLE

```

Console(config)#interface ethernet 1/1
Console(config-if)#power inline
Console(config-if)#exit
Console(config)#interface ethernet 1/2
Console(config-if)#no power inline
Console(config-if)#

```

RELATED COMMANDS

[time-range \(783\)](#)

**power inline
maximum allocation**

This command limits the power allocated to specific ports. Use the **no** form to restore the default setting.

SYNTAX

power inline maximum allocation *milliwatts*
no power inline maximum allocation

milliwatts - The maximum power budget for the port.
 (Range: 3000 - 34200 milliwatts)

DEFAULT SETTING

34200 milliwatts

COMMAND MODE

Interface Configuration

COMMAND USAGE

- ◆ For the ECS4110-28P, the total PoE power delivered by all ports cannot exceed the maximum power budget of 390W. For the ECS4110-52P, the total PoE power delivered by all ports cannot exceed the maximum power budget of 400W. All the RJ-45 ports support both the IEEE 802.3af and IEEE 802.3at standards. The maximum number of ports which can supply power simultaneously at the specified levels are shown in the following table.

Table 121: Maximum Number of Ports Providing Simultaneous Power

Switch	34.2W (802.3at)	15.4W (802.3af)	7.5W (802.3af)
ECS4110-28P	11	24	24
ECS4110-52P	11	25	48

- ◆ If a device is connected to a switch port and the switch detects that it requires more than the maximum power allocated to the port or to the overall switch, no power is supplied to the device (i.e., port power remains off).

EXAMPLE

```

Console(config)#interface ethernet 1/1
Console(config-if)#power inline maximum allocation 8000
Console(config-if)#

```

power inline priority This command sets the power priority for specific ports. Use the **no** form to restore the default setting.

SYNTAX

power inline priority *priority*
no power inline priority

priority - The power priority for the port.
 Options: 1 (critical), 2 (high), or 3 (low)

DEFAULT SETTING

3 (low)

COMMAND MODE

Interface Configuration

COMMAND USAGE

- ◆ If the power demand from devices connected to the switch exceeds the power budget setting as determined during bootup, the switch uses port power priority settings to control the supplied power. For example:
 - A device connected to a low-priority port that causes the switch to exceed its budget is not supplied power.
 - If a device is connected to a critical or high-priority port and would cause the switch to exceed its power budget as determined during bootup, power is provided to the port only if the switch can drop power to one or more lower-priority ports and thereby remain within its overall budget.
 - If a device is connected to a port after the switch has finished booting up and would cause the switch to exceed its budget, power will not be provided to that port regardless of its priority setting.
 - If a device is connected to a port after the switch has finished booting up and would cause the switch to exceed its budget, power will not be provided to that port regardless of its priority setting.

- If priority is not set for any ports, and PoE consumption exceeds the maximum power provided by the switch, power is shut down in the following sequence:

Table 122: PoE Shut Down Sequence

Switch	PoE Port Shut Down Sequence
ECS4110-28P	12, 11, 10, 9, 8, 7, 6, 5, 4, 3, 2, 1, 24, 23, 22, 21, 20, 19, 18, 17, 16, 15, 14, 13
ECS4110-52P	12, 11, 10, 9, 8, 7, 6, 5, 4, 3, 2, 1, 24, 23, 22, 21, 20, 19, 18, 17, 16, 15, 14, 13, 36, 35, 34, 33, 32, 31, 30, 29, 28, 27, 26, 25, 48, 47, 46, 45, 44, 43, 42, 41, 40, 39, 38, 37

EXAMPLE

```
Console(config)#interface ethernet 1/1
Console(config-if)#power inline priority 2
Console(config-if)#
```

power inline time-range This command binds a time-range to a port during which PoE is supplied to the attached device. Use the **no** form to remove this binding.

SYNTAX

power inline time-range *time-range-name*
no power inline time-range

time-range-name - Name of the time range.
 (Range: 1-30 characters)

DEFAULT SETTING

None

COMMAND MODE

Interface Configuration

EXAMPLE

```
Console(config)#interface ethernet 1/1
Console(config-if)#power inline time-range rd
Console(config-if)#
```

RELATED COMMANDS

[time-range \(783\)](#)

show power inline status This command displays the current power status for all ports or for specific ports.

SYNTAX

show power inline status [*interface*]

interface

ethernet

unit - Unit identifier. (Range: 1)

port - Port number. (Range: 1-24/48)

COMMAND MODE

Privileged Exec

EXAMPLE

```

Console#show power inline status
Unit: 1
Compatible mode : Disabled

```

Interface	Admin	Time Range	Oper	Max Power	Used Power	Priority
Eth 1/ 1	Enabled	--	On	34200 mW	8200 mW	Low
Eth 1/ 2	Enabled	--	Off	34200 mW	0 mW	Low
Eth 1/ 3	Enabled	--	Off	34200 mW	0 mW	Low
Eth 1/ 4	Enabled	--	Off	34200 mW	0 mW	Low
Eth 1/ 5	Enabled	--	Off	34200 mW	0 mW	Low
Eth 1/ 6	Enabled	--	Off	34200 mW	0 mW	Low
Eth 1/ 7	Enabled	--	Off	34200 mW	0 mW	Low
Eth 1/ 8	Enabled	--	Off	34200 mW	0 mW	Low
Eth 1/ 9	Enabled	--	Off	34200 mW	0 mW	Low
Eth 1/10	Enabled	--	Off	34200 mW	0 mW	Low
Eth 1/11	Enabled	--	Off	34200 mW	0 mW	Low
Eth 1/12	Enabled	--	Off	34200 mW	0 mW	Low
:						

Table 123: **show power inline status** - display description

Field	Description
Admin	The power mode set on the port (see power inline)
Time Range	Time during which power is supplied
Oper	The current operating power status (displays on or off)
Max Power	The maximum power allocated to this port (see power inline maximum allocation)
Used Power	The current power consumption on the port in milliwatts
Priority	The port's power priority setting (see power inline priority)

show power inline time-range This command displays the time-range and current status for specific ports or for all ports.

SYNTAX

show power inline time-range *time-range-name* [*interface*]

time-range-name - Name of the time range.
(Range: 1-30 characters)

interface

ethernet

unit - Unit identifier. (Range: 1)

port - Port number. (Range: 1-24/48)

COMMAND MODE

Privileged Exec

EXAMPLE

```

Console#show power inline time-range ethernet 1/5
Interface Time Range Name Status
-----
Eth 1/ 5 r&d Inactive
Console#

```

RELATED COMMANDS

[power inline \(1037\)](#)

show power mainpower Use this command to display the current power status for the switch.

COMMAND MODE

Privileged Exec

EXAMPLE

This example shows the maximum available PoE power and maximum allocated PoE power for the ECS4110-52P.

```

Console#show power mainpower
Unit 1 PoE Status
PoE Maximum Available Power : 400.0 Watts
PoE Maximum Allocation Power : 400.0 Watts
System Operation Status : On
PoE Power Consumption : 7.3 Watts
Software Version : Version 0068 (Hex), Build 00 (Hex)
Console#

```

Table 124: **show power mainpower** - display description

Field	Description
PoE Maximum Available Power	The available power budget for the switch
PoE Maximum Allocation Power	The overall maximum power which is currently allocated by the power mainpower maximum allocation command.
System Operation Status	The current operating power status (displays on or off)
PoE Power Consumption	The current power consumption on the switch in watts
Software Version	The version of software running on the PoE controller subsystem in the switch.

Data can be mirrored from a local port on the same switch or from a remote port on another switch for analysis at the target port using software monitoring tools or a hardware probe. This switch supports the following mirroring modes.

Table 125: Port Mirroring Commands

Command	Function
Local Port Mirroring	Mirrors data to another port for analysis without affecting the data passing through or the performance of the monitored port
RSPAN Mirroring	Mirrors data from remote switches over a dedicated VLAN

LOCAL PORT MIRRORING COMMANDS

This section describes how to mirror traffic from a source port to a target port.

Table 126: Mirror Port Commands

Command	Function	Mode
port monitor	Configures a mirror session	IC
show port monitor	Shows the configuration for a mirror port	PE

port monitor This command configures a mirror session. Use the **no** form to clear a mirror session.

SYNTAX

```
port monitor {interface [rx | tx | both] | vlan vlan-id |
mac-address mac-address | access-list acl-name}
```

```
no port monitor {interface | vlan vlan-id |
mac-address mac-address | access-list acl-name}
```

interface

ethernet *unit/port* (source port)

unit - Unit identifier. (Range: 1)

port - Port number. (Range: 1-28/52)

port-channel *channel-id* (Range: 1-16)

rx - Mirror received packets.

tx - Mirror transmitted packets.

both - Mirror both received and transmitted packets.

vlan-id - VLAN ID (Range: 1-4094)

mac-address - MAC address in the form of xx-xx-xx-xx-xx-xx or xxxxxxxxxxxx.

acl-name - Name of the ACL. (Maximum length: 16 characters, no spaces or other special characters)

DEFAULT SETTING

- ◆ No mirror session is defined.
- ◆ When enabled for an interface, default mirroring is for both received and transmitted packets.
- ◆ When enabled for a VLAN or a MAC address, mirroring is restricted to received packets.

COMMAND MODE

Interface Configuration (Ethernet, destination port)

COMMAND USAGE

- ◆ You can mirror traffic from any source port or trunk to a destination port for real-time analysis. You can then attach a logic analyzer or RMON probe to the destination port and study the traffic crossing the source port or trunk in a completely unobtrusive manner.
- ◆ Set the destination port by specifying an Ethernet interface with the **interface** configuration command, and then use the **port monitor** command to specify the source of the traffic to mirror. Note that the destination port cannot be a trunk or trunk member port.
- ◆ When mirroring traffic from a port or trunk, the mirror port/trunk and monitor port speeds should match, otherwise traffic may be dropped from the monitor port. When mirroring traffic from a VLAN, traffic may also be dropped under heavy loads.
- ◆ When VLAN mirroring and port or trunk mirroring are both enabled, the target port can receive a mirrored packet twice; once from the source mirror port or trunk and again from the source mirror VLAN.
- ◆ When mirroring traffic from a MAC address, ingress traffic with the specified source address entering any port in the switch, other than the target port, will be mirrored to the destination port.
- ◆ When mirroring VLAN traffic or packets based on a source MAC address, the target port cannot be set to the same target port as that used for basic port mirroring.
- ◆ Spanning Tree BPDU packets are not mirrored to the target port.
- ◆ You can create multiple mirror sessions, but all sessions must share the same destination port.

- ◆ The destination port cannot be a trunk or trunk member port.
- ◆ ACL-based mirroring is only used for ingress traffic. To mirror an ACL, follow these steps:
 1. Use the **access-list** command (page 969) to add an ACL.
 2. Use the **access-group** command to add a mirrored port to access control list.
 3. Use the **port monitor access-list** command to specify the destination port to which traffic matching the ACL will be mirrored.

EXAMPLE

The following example configures the switch to mirror all packets from port 6 to 5:

```
Console(config)#interface ethernet 1/5
Console(config-if)#port monitor ethernet 1/6 both
Console(config-if)#
```

This example configures port 2 to monitor packets matching the MAC address 00-12-CF-XX-XX-XX received by port 1:

```
Console(config)#access-list mac m1
Console(config-mac-acl)#permit 00-12-cf-00-00-00 ff-ff-ff-00-00-00 any
Console(config-mac-acl)#exit
Console(config)#interface ethernet 1/1
Console(config-if)#mac access-group m1 in
Console(config-if)#interface ethernet 1/2
Console(config-if)#port monitor access-list m1
Console(config-if)#
```

show port monitor This command displays mirror information.

SYNTAX

show port monitor [*interface* | **vlan** *vlan-id* | **mac-address** *mac-address*]

interface - **ethernet** *unit/port* (source port)

unit - Unit identifier. (Range: 1)

port - Port number. (Range: 1-28/52)

vlan-id - VLAN ID (Range: 1-4094)

mac-address - MAC address in the form of xx-xx-xx-xx-xx-xx or xxxxxxxxxxxxxx.

DEFAULT SETTING

Shows all sessions.

COMMAND MODE

Privileged Exec

COMMAND USAGE

This command displays the currently configured source port, destination port, and mirror mode (i.e., RX, TX, RX/TX).

EXAMPLE

The following shows mirroring configured from port 6 to port 11:

```
Console(config)#interface ethernet 1/11
Console(config-if)#port monitor ethernet 1/6
Console(config-if)#end
Console#show port monitor
Port Mirroring
-----
Destination Port (listen port): Eth1/11
Source Port (monitored port)   : Eth1/ 6
Mode                           :RX/TX
Console#
```

RSPAN MIRRORING COMMANDS

Remote Switched Port Analyzer (RSPAN) allows you to mirror traffic from remote switches for analysis on a local destination port.

Table 127: RSPAN Commands

Command	Function	Mode
<code>vlan rspan</code>	Creates a VLAN dedicated to carrying RSPAN traffic	VC
<code>rspan source</code>	Specifies the source port and traffic type to be mirrored	GC
<code>rspan destination</code>	Specifies the destination port to monitor the mirrored traffic	GC
<code>rspan remote vlan</code>	Specifies the RSPAN VLAN, switch role (source, intermediate or destination), and the uplink ports	GC
<code>no rspan session</code>	Deletes a configured RSPAN session	GC
<code>show rspan</code>	Displays the configuration settings for an RSPAN session	PE

Configuration Guidelines

Take the following steps to configure an RSPAN session:

1. Use the `vlan rspan` command to configure a VLAN to use for RSPAN. (Default VLAN 1 is prohibited.)
2. Use the `rspan source` command to specify the interfaces and the traffic type (RX, TX or both) to be monitored.

3. Use the `rspan destination` command to specify the destination port for the traffic mirrored by an RSPAN session.
4. Use the `rspan remote vlan` command to specify the VLAN to be used for an RSPAN session, to specify the switch's role as a source, intermediate relay, or destination of the mirrored traffic, and to configure the uplink ports designated to carry this traffic.

RSPAN Limitations

The following limitations apply to the use of RSPAN on this switch:

- ◆ *RSPAN Ports* – Only ports can be configured as an RSPAN source, destination, or uplink; static and dynamic trunks are not allowed. A port can only be configured as one type of RSPAN interface – source, destination, or uplink. Also, note that the source port and destination port cannot be configured on the same switch.

Only 802.1Q trunk or hybrid (i.e., general use) ports can be configured as an RSPAN uplink or destination port – access ports are not allowed (see `switchport mode`).
- ◆ *Local/Remote Mirror* – The destination of a local mirror session (created with the `port monitor` command) cannot be used as the destination for RSPAN traffic.

Only one mirror session is allowed, including both local and remote mirroring. If local mirroring is enabled, then no session can be configured for RSPAN.
- ◆ *Spanning Tree* – If the spanning tree is disabled, BPDUs will not be flooded onto the RSPAN VLAN.

MAC address learning is not supported on RSPAN uplink ports when RSPAN is enabled on the switch. Therefore, even if spanning tree is enabled after RSPAN has been configured, MAC address learning will still not be re-started on the RSPAN uplink ports.
- ◆ *IEEE 802.1X* – RSPAN and 802.1X are mutually exclusive functions. When 802.1X is enabled globally, RSPAN uplink ports cannot be configured, even though RSPAN source and destination ports can still be configured. When RSPAN uplink ports are enabled on the switch, 802.1X cannot be enabled globally.

RSPAN uplink ports cannot be configured to use IEEE 802.1X Port Authentication, but RSPAN source ports and destination ports can be configured to use it.
- ◆ *Port Security* – If port security is enabled on any port, that port cannot be set as an RSPAN uplink port, even though it can still be configured as an RSPAN source or destination port. Also, when a port is configured as an RSPAN uplink port, port security cannot be enabled on that port.

rspan source Use this command to specify the source port and traffic type to be mirrored remotely. Use the **no** form to disable RSPAN on the specified port, or with a traffic type keyword to disable mirroring for the specified type.

SYNTAX

```
[no] rspan session session-id source interface interface-list  
[rx | tx | both]
```

session-id – A number identifying this RSPAN session. (Range: 1)

Only one mirror sessions is allowed, including both local and remote mirroring. If local mirroring is enabled with the [port monitor](#) command, then no session can be configured for RSPAN.

interface-list – One or more source ports. Use a hyphen to indicate a consecutive list of ports or a comma between non-consecutive ports.

ethernet *unit/port*

unit - Unit identifier. (Range: 1)

port - Port number. (Range: 1-28/52)

rx - Mirror received packets.

tx - Mirror transmitted packets.

both - Mirror both received and transmitted packets.

DEFAULT SETTING

Both TX and RX traffic is mirrored

COMMAND MODE

Global Configuration

COMMAND USAGE

- ◆ One or more source ports can be assigned to the same RSPAN session, either on the same switch or on different switches.
- ◆ Only ports can be configured as an RSPAN source – static and dynamic trunks are not allowed.
- ◆ The source port and destination port cannot be configured on the same switch.

EXAMPLE

The following example configures the switch to mirror received packets from port 2 and 3:

```
Console(config)#rspan session 1 source interface ethernet 1/2  
Console(config)#rspan session 1 source interface ethernet 1/3  
Console(config)#
```

rspan destination Use this command to specify the destination port to monitor the mirrored traffic. Use the **no** form to disable RSPAN on the specified port.

SYNTAX

rspan session *session-id* **destination interface** *interface* [**tagged** | **untagged**]

no rspan session *session-id* **destination interface** *interface*

session-id – A number identifying this RSPAN session. (Range: 1)

Only one mirror session is allowed, including both local and remote mirroring. If local mirroring is enabled with the [port monitor](#) command, then no session can be configured for RSPAN.

interface - **ethernet** *unit/port*

unit - Unit identifier. (Range: 1)

port - Port number. (Range: 1-28/52)

tagged - Traffic exiting the destination port carries the RSPAN VLAN tag.

untagged - Traffic exiting the destination port is untagged.

DEFAULT SETTING

Traffic exiting the destination port is untagged.

COMMAND MODE

Global Configuration

COMMAND USAGE

- ◆ Only one destination port can be configured on the same switch per session, but a destination port can be configured on more than one switch for the same session.
- ◆ Only 802.1Q trunk or hybrid (i.e., general use) ports can be configured as an RSPAN destination port – access ports are not allowed (see [switchport mode](#)).
- ◆ Only ports can be configured as an RSPAN destination – static and dynamic trunks are not allowed.
- ◆ The source port and destination port cannot be configured on the same switch.
- ◆ A destination port can still send and receive switched traffic, and participate in any Layer 2 protocols to which it has been assigned.

EXAMPLE

The following example configures port 4 to receive mirrored RSPAN traffic:

```
Console(config)#rspan session 1 destination interface ethernet 1/2
Console(config)#
```

rspan remote vlan Use this command to specify the RSPAN VLAN, switch role (source, intermediate or destination), and the uplink ports. Use the **no** form to disable the RSPAN on the specified VLAN.

SYNTAX

```
[no] rspan session session-id remote vlan vlan-id  
      {source | intermediate | destination} uplink interface
```

session-id – A number identifying this RSPAN session. (Range: 1)

Only one mirror session is allowed, including both local and remote mirroring. If local mirroring is enabled with the [port monitor](#) command, then no session can be configured for RSPAN.

vlan-id - ID of configured RSPAN VLAN. (Range: 1-4094)

Use the [vlan rspan](#) command to reserve a VLAN for RSPAN mirroring before enabling RSPAN with this command.

source - Specifies this device as the source of remotely mirrored traffic.

intermediate - Specifies this device as an intermediate switch, transparently passing mirrored traffic from one or more sources to one or more destinations.

destination - Specifies this device as a switch configured with a destination port which is to receive mirrored traffic for this session.

uplink - A port configured to receive or transmit remotely mirrored traffic.

interface - **ethernet** *unit/port*

ethernet *unit/port*

unit - Unit identifier. (Range: 1)

port - Port number. (Range: 1-28/52)

DEFAULT SETTING

None

COMMAND MODE

Global Configuration

COMMAND USAGE

- ◆ Only 802.1Q trunk or hybrid (i.e., general use) ports can be configured as an RSPAN uplink port – access ports are not allowed (see [switchport mode](#)).
- ◆ Only one uplink port can be configured on a source switch, but there is no limitation on the number of uplink ports configured on an intermediate or destination switch.
- ◆ Only destination and uplink ports will be assigned by the switch as members of this VLAN. Ports cannot be manually assigned to an RSPAN VLAN with the [switchport allowed vlan](#) command. Nor can GVRP dynamically add port members to an RSPAN VLAN. Also, note that the

`show vlan` command will not display any members for an RSPAN VLAN, but will only show configured RSPAN VLAN identifiers.

EXAMPLE

The following example enables RSPAN on VLAN 2, specifies this device as an RSPAN destination switch, and the uplink interface as port 3:

```
Console(config)#rspan session 1 remote vlan 2 destination uplink ethernet 1/3
Console(config)#
```

no rspan session Use this command to delete a configured RSPAN session.

SYNTAX

no rspan session *session-id*

session-id – A number identifying this RSPAN session. (Range: 1)

Only one mirror session is allowed, including both local and remote mirroring. If local mirroring is enabled with the [port monitor](#) command, then no session can be configured for RSPAN.

COMMAND MODE

Global Configuration

COMMAND USAGE

The **no rspan session** command must be used to disable an RSPAN VLAN before it can be deleted from the VLAN database (see the [vlan](#) command).

EXAMPLE

```
Console(config)#no rspan session 1
Console(config)#
```

show rspan Use this command to displays the configuration settings for an RSPAN session.

SYNTAX

show rspan session [*session-id*]

session-id – A number identifying this RSPAN session. (Range: 1)

Only one mirror session is allowed, including both local and remote mirroring. If local mirroring is enabled with the [port monitor](#) command, then no session can be configured for RSPAN.

COMMAND MODE

Privileged Exec

EXAMPLE

```
Console#show rspan session
RSPAN Session ID           : 1
Source Ports (mirrored ports) : None
  RX Only                   : None
  TX Only                   : None
  BOTH                      : None
Destination Port (monitor port) : Eth 1/2
Destination Tagged Mode      : Untagged
Switch Role                  : Destination
RSPAN VLAN                   : 2
RSPAN Uplink Ports          : Eth 1/3
Operation Status             : Up
Console#
```

The switch can set the maximum upload or download data transfer rate for any port. It can control traffic storms by setting a maximum threshold for broadcast traffic or multicast traffic. It can also set bounding thresholds for broadcast and multicast storms which can be used to automatically trigger rate limits or to shut down a port.

Table 128: Congestion Control Commands

Command Group	Function
Rate Limiting	Sets the input and output rate limits for a port.
Storm Control	Sets the traffic storm threshold for each port.
Automatic Traffic Control	Sets thresholds for broadcast and multicast storms which can be used to trigger configured rate limits or to shut down a port.

RATE LIMIT COMMANDS

Rate limit commands allow the network manager to control the maximum rate for traffic transmitted or received on an interface. Rate limiting is configured on interfaces at the edge of a network to limit traffic into or out of the network. Packets that exceed the acceptable amount of traffic are dropped.

Rate limiting can be applied to individual ports or trunks. When an interface is configured with this feature, the traffic rate will be monitored by the hardware to verify conformity. Non-conforming traffic is dropped.

Table 129: Rate Limit Commands

Command	Function	Mode
rate-limit	Configures the maximum input or output rate for an interface	IC

rate-limit This command defines the rate limit for a specific interface. Use this command without specifying a rate to enable rate limiting. Use the **no** form to disable rate limiting.

SYNTAX

rate-limit {**input** | **output**} [*rate*]

no rate-limit {**input** | **output**}

input – Input rate for specified interface

output – Output rate for specified interface

rate – Maximum value in kbps. (Range: 64-1000000 kbps)

DEFAULT SETTING

Disabled

COMMAND MODE

Interface Configuration (Ethernet, Port Channel)

COMMAND USAGE

Using both rate limiting and storm control on the same interface may lead to unexpected results. It is therefore not advisable to use both of these commands on the same interface.

EXAMPLE

```
Console(config)#interface ethernet 1/1
Console(config-if)#rate-limit input 64
Console(config-if)#
```

RELATED COMMAND

[show interfaces switchport \(1008\)](#)

STORM CONTROL COMMANDS

Storm control commands can be used to configure broadcast, multicast, and unknown unicast storm control thresholds. Traffic storms may occur when a device on your network is malfunctioning, or if application programs are not well designed or properly configured. If there is too much traffic on your network, performance can be severely degraded or everything can come to complete halt.

You can protect your network from traffic storms by setting a threshold for broadcast, multicast or unknown unicast traffic. Any packets exceeding the specified threshold will then be dropped.

Table 130: Rate Limit Commands

Command	Function	Mode
<code>switchport packet-rate*</code>	Configures broadcast, multicast, and unknown unicast storm control thresholds	IC
<code>show interfaces switchport</code>	Displays the administrative and operational status of an interface	NE, PE

* Enabling hardware-level storm control with this command on a port will disable software-level automatic storm control on the same port if configured by the `auto-traffic-control` command.

switchport packet-rate This command configures broadcast, multicast and unknown unicast storm control. Use the **no** form to restore the default setting.

SYNTAX

```
switchport {broadcast | multicast | unknown-unicast}
packet-rate rate
```

```
no switchport {broadcast | multicast | unknown-unicast}
```

broadcast - Specifies storm control for broadcast traffic.

multicast - Specifies storm control for multicast traffic.

unicast - Specifies storm control for unknown unicast traffic.

rate - Threshold level as a rate. (Range: 500-1488100 pps)

DEFAULT SETTING

Broadcast Storm Control: Enabled, 500 pbps

Multicast Storm Control: Disabled

Unknown Unicast Storm Control: Disabled

COMMAND MODE

Interface Configuration (Ethernet, Port Channel)

COMMAND USAGE

- ◆ When traffic exceeds the threshold specified for broadcast and multicast or unknown unicast traffic, packets exceeding the threshold are dropped until the rate falls back down beneath the threshold.

- ◆ Traffic storms can be controlled at the hardware level using this command or at the software level using the [auto-traffic-control](#) command. However, only one of these control types can be applied to a port. Enabling hardware-level storm control on a port will disable automatic storm control on that port.
- ◆ The rate limits set by this command are also used by automatic storm control when the control response is set to rate limiting by the [auto-traffic-control action](#) command.
- ◆ Using both rate limiting and storm control on the same interface may lead to unexpected results. It is therefore not advisable to use both of these commands on the same interface.

EXAMPLE

The following shows how to configure broadcast storm control at 600 packets per second:

```
Console(config)#interface ethernet 1/5
Console(config-if)#switchport broadcast packet-rate 600
Console(config-if)#
```

RELATED COMMANDS

[show interfaces switchport \(1008\)](#)

AUTOMATIC TRAFFIC CONTROL COMMANDS

Automatic Traffic Control (ATC) configures bounding thresholds for broadcast and multicast storms which can be used to trigger configured rate limits or to shut down a port.

Table 131: ATC Commands

Command	Function	Mode
<i>Threshold Commands</i>		
auto-traffic-control apply-timer	Sets the time at which to apply the control response after ingress traffic has exceeded the upper threshold	GC
auto-traffic-control release-timer	Sets the time at which to release the control response after ingress traffic has fallen beneath the lower threshold	GC
auto-traffic-control*	Enables automatic traffic control for broadcast or multicast storms	IC (Port)
auto-traffic-control action	Sets the control action to limit ingress traffic or shut down the offending port	IC (Port)
auto-traffic-control alarm-clear-threshold	Sets the lower threshold for ingress traffic beneath which a cleared storm control trap is sent	IC (Port)
auto-traffic-control alarm-fire-threshold	Sets the upper threshold for ingress traffic beyond which a storm control response is triggered after the apply timer expires	IC (Port)

Table 131: ATC Commands (Continued)

Command	Function	Mode
<code>auto-traffic-control auto-control-release</code>	Automatically releases a control response	IC (Port)
<code>auto-traffic-control control-release</code>	Manually releases a control response	IC (Port)
<i>SNMP Trap Commands</i>		
<code>snmp-server enable port-traps atc broadcast-alarm-clear</code>	Sends a trap when broadcast traffic falls beneath the lower threshold after a storm control response has been triggered	IC (Port)
<code>snmp-server enable port-traps atc broadcast-alarm-fire</code>	Sends a trap when broadcast traffic exceeds the upper threshold for automatic storm control	IC (Port)
<code>snmp-server enable port-traps atc broadcast-control-apply</code>	Sends a trap when broadcast traffic exceeds the upper threshold for automatic storm control and the apply timer expires	IC (Port)
<code>snmp-server enable port-traps atc broadcast-control-release</code>	Sends a trap when broadcast traffic falls beneath the lower threshold after a storm control response has been triggered and the release timer expires	IC (Port)
<code>snmp-server enable port-traps atc multicast-alarm-clear</code>	Sends a trap when multicast traffic falls beneath the lower threshold after a storm control response has been triggered	IC (Port)
<code>snmp-server enable port-traps atc multicast-alarm-fire</code>	Sends a trap when multicast traffic exceeds the upper threshold for automatic storm control	IC (Port)
<code>snmp-server enable port-traps atc multicast-control-apply</code>	Sends a trap when multicast traffic exceeds the upper threshold for automatic storm control and the apply timer expires	IC (Port)
<code>snmp-server enable port-traps atc multicast-control-release</code>	Sends a trap when multicast traffic falls beneath the lower threshold after a storm control response has been triggered and the release timer expires	IC (Port)
<i>ATC Display Commands</i>		
<code>show auto-traffic-control</code>	Shows global configuration settings for automatic storm control	PE
<code>show auto-traffic-control interface</code>	Shows interface configuration settings and storm control status for the specified port	PE

* Enabling automatic storm control on a port will disable hardware-level storm control on the same port if configured by the `switchport packet-rate` command.

USAGE GUIDELINES

ATC includes storm control for broadcast or multicast traffic. The control response for either of these traffic types is the same, as shown in the following diagrams.

Figure 421: Storm Control by Limiting the Traffic Rate

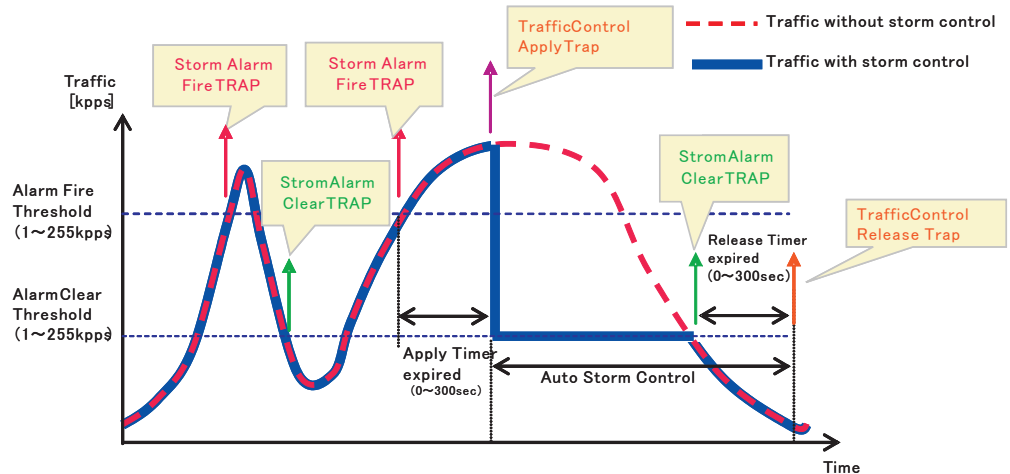

The key elements of this diagram are described below:

- ◆ Alarm Fire Threshold – The highest acceptable traffic rate. When ingress traffic exceeds the threshold, ATC sends a Storm Alarm Fire Trap and logs it.
- ◆ When traffic exceeds the alarm fire threshold and the apply timer expires, a traffic control response is applied, and a Traffic Control Apply Trap is sent and logged.
- ◆ Alarm Clear Threshold – The lower threshold beneath which a control response can be automatically terminated after the release timer expires. When ingress traffic falls below this threshold, ATC sends a Storm Alarm Clear Trap and logs it.
- ◆ When traffic falls below the alarm clear threshold after the release timer expires, traffic control (for rate limiting) will be stopped and a Traffic Control Release Trap sent and logged. Note that if the control action has shut down a port, it can only be manually re-enabled using the [auto-traffic-control control-release](#) command).
- ◆ The traffic control response of rate limiting can be released automatically or manually. The control response of shutting down a port can only be released manually.

Figure 422: Storm Control by Shutting Down a Port

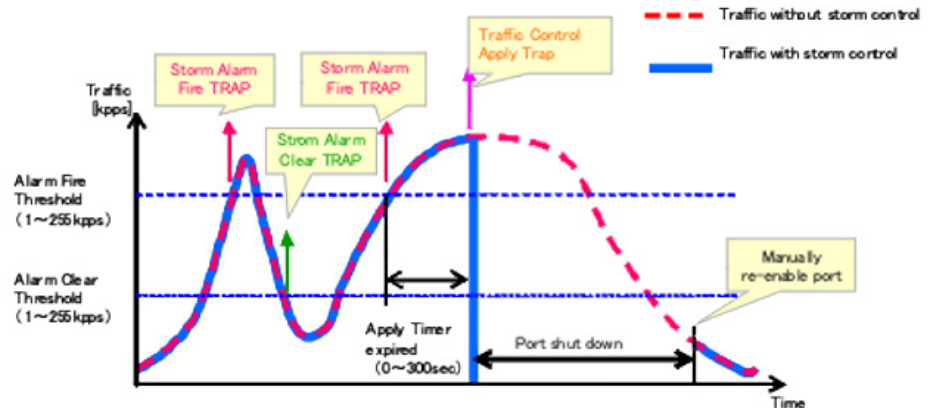

The key elements of this diagram are the same as that described in the preceding diagram, except that automatic release of the control response is not provided. When traffic control is applied, you must manually re-enable the port.

FUNCTIONAL LIMITATIONS

Automatic storm control is a software level control function. Traffic storms can also be controlled at the hardware level using the [switchport packet-rate](#) command. However, only one of these control types can be applied to a port. Enabling automatic storm control on a port will disable hardware-level storm control on that port.

Threshold Commands

**auto-traffic-control
apply-timer**

This command sets the time at which to apply the control response after ingress traffic has exceeded the upper threshold. Use the **no** form to restore the default setting.

SYNTAX

- auto-traffic-control {broadcast | multicast} apply-timer seconds**
- no auto-traffic-control {broadcast | multicast} apply-timer**
- broadcast** - Specifies automatic storm control for broadcast traffic.
- multicast** - Specifies automatic storm control for multicast traffic.
- seconds** - The interval after the upper threshold has been exceeded at which to apply the control response. (Range: 1-300 seconds)

DEFAULT SETTING
300 seconds

COMMAND MODE
Global Configuration

COMMAND USAGE

After the apply timer expires, a control action may be triggered as specified by the [auto-traffic-control action](#) command and a trap message sent as specified by the [snmp-server enable port-traps atc broadcast-control-apply](#) command or [snmp-server enable port-traps atc multicast-control-apply](#) command.

EXAMPLE

This example sets the apply timer to 200 seconds for all ports.

```
Console(config)#auto-traffic-control broadcast apply-timer 200
Console(config)#
```

auto-traffic-control release-timer

This command sets the time at which to release the control response after ingress traffic has fallen beneath the lower threshold. Use the **no** form to restore the default setting.

SYNTAX

auto-traffic-control {**broadcast** | **multicast**}
release-timer *seconds*

no auto-traffic-control {**broadcast** | **multicast**} **release-timer**

broadcast - Specifies automatic storm control for broadcast traffic.

multicast - Specifies automatic storm control for multicast traffic.

seconds - The time at which to release the control response after ingress traffic has fallen beneath the lower threshold.

(Range: 1-900 seconds)

DEFAULT SETTING

900 seconds

COMMAND MODE

Global Configuration

COMMAND USAGE

This command sets the delay after which the control response can be terminated. The [auto-traffic-control auto-control-release](#) command must be used to enable or disable the automatic release of a control response of rate-limiting. To re-enable a port which has been shut down by automatic traffic control, you must manually re-enable the port using the [auto-traffic-control control-release](#) command.

EXAMPLE

This example sets the release timer to 800 seconds for all ports.

```
Console(config)#auto-traffic-control broadcast release-timer 800
Console(config)#
```

auto-traffic-control This command enables automatic traffic control for broadcast or multicast storms. Use the **no** form to disable this feature.

SYNTAX

[no] auto-traffic-control {broadcast | multicast}

broadcast - Specifies automatic storm control for broadcast traffic.

multicast - Specifies automatic storm control for multicast traffic.

DEFAULT SETTING

Disabled

COMMAND MODE

Interface Configuration (Ethernet)

COMMAND USAGE

- ◆ Automatic storm control can be enabled for either broadcast or multicast traffic. It cannot be enabled for both of these traffic types at the same time.
- ◆ Automatic storm control is a software level control function. Traffic storms can also be controlled at the hardware level using the [switchport packet-rate](#) command. However, only one of these control types can be applied to a port. Enabling automatic storm control on a port will disable hardware-level storm control on that port.

EXAMPLE

This example enables automatic storm control for broadcast traffic on port 1.

```
Console(config)#interface ethernet 1/1
Console(config-if)#auto-traffic-control broadcast
Console(config-if)#
```

auto-traffic-control action This command sets the control action to limit ingress traffic or shut down the offending port. Use the **no** form to restore the default setting.

SYNTAX

**auto-traffic-control {broadcast | multicast} action
{rate-control | shutdown}**

no auto-traffic-control {broadcast | multicast} action

broadcast - Specifies automatic storm control for broadcast traffic.

multicast - Specifies automatic storm control for multicast traffic.

rate-control - If a control response is triggered, the rate of ingress traffic is limited based on the threshold configured by the [auto-traffic-control alarm-clear-threshold](#) command.

shutdown - If a control response is triggered, the port is administratively disabled. A port disabled by automatic traffic control can only be manually re-enabled.

DEFAULT SETTING

rate-control

COMMAND MODE

Interface Configuration (Ethernet)

COMMAND USAGE

- ◆ When the upper threshold is exceeded and the apply timer expires, a control response will be triggered based on this command.
- ◆ When the control response is set to rate limiting by this command, the rate limits are determined by the [auto-traffic-control alarm-clear-threshold](#) command.
- ◆ If the control response is to limit the rate of ingress traffic, it can be automatically terminated once the traffic rate has fallen beneath the lower threshold and the release timer has expired.
- ◆ If a port has been shut down by a control response, it will not be re-enabled by automatic traffic control. It can only be manually re-enabled using the [auto-traffic-control control-release](#) command.

EXAMPLE

This example sets the control response for broadcast traffic on port 1.

```
Console(config)#interface ethernet 1/1
Console(config-if)#auto-traffic-control broadcast action shutdown
Console(config-if)#
```

auto-traffic-control alarm-clear- threshold

This command sets the lower threshold for ingress traffic beneath which a control response for rate limiting will be released after the Release Timer expires, if so configured by the [auto-traffic-control auto-control-release](#) command. Use the **no** form to restore the default setting.

SYNTAX

```
auto-traffic-control {broadcast | multicast}  
alarm-clear-threshold threshold
```

```
no auto-traffic-control {broadcast | multicast}  
alarm-clear-threshold
```

broadcast - Specifies automatic storm control for broadcast traffic.

multicast - Specifies automatic storm control for multicast traffic.

threshold - The lower threshold for ingress traffic beneath which a cleared storm control trap is sent. (Range: 1-255 kilo-packets per second)

DEFAULT SETTING

250 kilo-packets per second

COMMAND MODE

Interface Configuration (Ethernet)

COMMAND USAGE

- ◆ Once the traffic rate falls beneath the lower threshold, a trap message may be sent if configured by the `snmp-server enable port-traps atc broadcast-alarm-clear` command or `snmp-server enable port-traps atc multicast-alarm-clear` command.
- ◆ If rate limiting has been configured as a control response, it will be discontinued after the traffic rate has fallen beneath the lower threshold, and the release timer has expired. Note that if a port has been shut down by a control response, it will not be re-enabled by automatic traffic control. It can only be manually re-enabled using the `auto-traffic-control control-release` command.

EXAMPLE

This example sets the clear threshold for automatic storm control for broadcast traffic on port 1.

```
Console(config)#interface ethernet 1/1
Console(config-if)#auto-traffic-control broadcast alarm-clear-threshold 155
Console(config-if)#
```

**auto-traffic-control
alarm-fire-threshold**

This command sets the upper threshold for ingress traffic beyond which a storm control response is triggered after the apply timer expires. Use the **no** form to restore the default setting.

SYNTAX

auto-traffic-control {**broadcast** | **multicast**}
alarm-fire-threshold *threshold*

no auto-traffic-control {**broadcast** | **multicast**}
alarm-fire-threshold

broadcast - Specifies automatic storm control for broadcast traffic.

multicast - Specifies automatic storm control for multicast traffic.

threshold - The upper threshold for ingress traffic beyond which a storm control response is triggered after the apply timer expires.
(Range: 1-255 kilo-packets per second)

DEFAULT SETTING

250 kilo-packets per second

COMMAND MODE

Interface Configuration (Ethernet)

COMMAND USAGE

- ◆ Once the upper threshold is exceeded, a trap message may be sent if configured by the `snmp-server enable port-traps atc broadcast-alarm-fire` command or `snmp-server enable port-traps atc multicast-alarm-fire` command.
- ◆ After the upper threshold is exceeded, the control timer must first expire as configured by the `auto-traffic-control apply-timer` command before a control response is triggered if configured by the `auto-traffic-control action` command.

EXAMPLE

This example sets the trigger threshold for automatic storm control for broadcast traffic on port 1.

```
Console(config)#interface ethernet 1/1
Console(config-if)#auto-traffic-control broadcast alarm-fire-threshold 255
Console(config-if)#
```

auto-traffic-control auto-control-release

This command automatically releases a control response of rate-limiting after the time specified in the `auto-traffic-control release-timer` command has expired.

SYNTAX

**auto-traffic-control {broadcast | multicast}
auto-control-release**

broadcast - Specifies automatic storm control for broadcast traffic.

multicast - Specifies automatic storm control for multicast traffic.

COMMAND MODE

Interface Configuration (Ethernet)

COMMAND USAGE

- ◆ This command can be used to automatically stop a control response of rate-limiting after the specified action has been triggered and the release timer has expired.
- ◆ To release a control response which has shut down a port after the specified action has been triggered and the release timer has expired, use the `auto-traffic-control control-release` command.

EXAMPLE

```
Console(config)#interface ethernet 1/1
Console(config-if)#auto-traffic-control broadcast auto-control-release
Console(config-if)#
```

auto-traffic-control control-release This command manually releases a control response.

SYNTAX

auto-traffic-control {broadcast | multicast} control-release

broadcast - Specifies automatic storm control for broadcast traffic.

multicast - Specifies automatic storm control for multicast traffic.

COMMAND MODE

Interface Configuration (Ethernet)

COMMAND USAGE

This command can be used to manually stop a control response of rate-limiting or port shutdown any time after the specified action has been triggered.

EXAMPLE

```
Console(config)#interface ethernet 1/1
Console(config-if)#auto-traffic-control broadcast control-release
Console(config-if)#
```

SNMP Trap Commands

snmp-server enable port-traps atc broadcast-alarm-clear This command sends a trap when broadcast traffic falls beneath the lower threshold after a storm control response has been triggered. Use the **no** form to disable this trap.

SYNTAX

[no] snmp-server enable port-traps atc broadcast-alarm-clear

DEFAULT SETTING

Disabled

COMMAND MODE

Interface Configuration (Ethernet)

EXAMPLE

```
Console(config)#interface ethernet 1/1
Console(config-if)#snmp-server enable port-traps atc broadcast-alarm-clear
Console(config-if)#
```

RELATED COMMANDS

[auto-traffic-control action \(1063\)](#)

[auto-traffic-control alarm-clear-threshold \(1064\)](#)

snmp-server enable port-traps atc broadcast-alarm-fire This command sends a trap when broadcast traffic exceeds the upper threshold for automatic storm control. Use the **no** form to disable this trap.

SYNTAX

[no] snmp-server enable port-traps atc broadcast-alarm-fire

DEFAULT SETTING

Disabled

COMMAND MODE

Interface Configuration (Ethernet)

EXAMPLE

```
Console(config)#interface ethernet 1/1
Console(config-if)#snmp-server enable port-traps atc broadcast-alarm-fire
Console(config-if)#
```

RELATED COMMANDS

[auto-traffic-control alarm-fire-threshold \(1065\)](#)

snmp-server enable port-traps atc broadcast-control-apply This command sends a trap when broadcast traffic exceeds the upper threshold for automatic storm control and the apply timer expires. Use the **no** form to disable this trap.

SYNTAX

[no] snmp-server enable port-traps atc broadcast-control-apply

DEFAULT SETTING

Disabled

COMMAND MODE

Interface Configuration (Ethernet)

EXAMPLE

```
Console(config)#interface ethernet 1/1
Console(config-if)#snmp-server enable port-traps atc broadcast-control-apply
Console(config-if)#
```

RELATED COMMANDS

[auto-traffic-control alarm-fire-threshold \(1065\)](#)

[auto-traffic-control apply-timer \(1061\)](#)

**snmp-server
enable port-traps
atc broadcast-
control-release**

This command sends a trap when broadcast traffic falls beneath the lower threshold after a storm control response has been triggered and the release timer expires. Use the **no** form to disable this trap.

SYNTAX

```
[no] snmp-server enable port-traps atc  
broadcast-control-release
```

DEFAULT SETTING

Disabled

COMMAND MODE

Interface Configuration (Ethernet)

EXAMPLE

```
Console(config)#interface ethernet 1/1  
Console(config-if)#snmp-server enable port-traps atc broadcast-control-  
release  
Console(config-if)#
```

RELATED COMMANDS

[auto-traffic-control alarm-clear-threshold \(1064\)](#)

[auto-traffic-control action \(1063\)](#)

[auto-traffic-control release-timer \(1062\)](#)

**snmp-server
enable port-traps
atc multicast-alarm-
clear**

This command sends a trap when multicast traffic falls beneath the lower threshold after a storm control response has been triggered. Use the **no** form to disable this trap.

SYNTAX

```
[no] snmp-server enable port-traps atc multicast-alarm-clear
```

DEFAULT SETTING

Disabled

COMMAND MODE

Interface Configuration (Ethernet)

EXAMPLE

```
Console(config)#interface ethernet 1/1  
Console(config-if)#snmp-server enable port-traps atc multicast-alarm-clear  
Console(config-if)#
```

RELATED COMMANDS

[auto-traffic-control action \(1063\)](#)

[auto-traffic-control alarm-clear-threshold \(1064\)](#)

snmp-server enable port-traps atc multicast-alarm-fire This command sends a trap when multicast traffic exceeds the upper threshold for automatic storm control. Use the **no** form to disable this trap.

SYNTAX

[no] snmp-server enable port-traps atc multicast-alarm-fire

DEFAULT SETTING

Disabled

COMMAND MODE

Interface Configuration (Ethernet)

EXAMPLE

```
Console(config)#interface ethernet 1/1
Console(config-if)#snmp-server enable port-traps atc multicast-alarm-fire
Console(config-if)#
```

RELATED COMMANDS

[auto-traffic-control alarm-fire-threshold \(1065\)](#)

snmp-server enable port-traps atc multicast-control-apply This command sends a trap when multicast traffic exceeds the upper threshold for automatic storm control and the apply timer expires. Use the **no** form to disable this trap.

SYNTAX

[no] snmp-server enable port-traps atc multicast-control-apply

DEFAULT SETTING

Disabled

COMMAND MODE

Interface Configuration (Ethernet)

EXAMPLE

```
Console(config)#interface ethernet 1/1
Console(config-if)#snmp-server enable port-traps atc multicast-control-apply
Console(config-if)#
```

RELATED COMMANDS

[auto-traffic-control alarm-fire-threshold \(1065\)](#)

[auto-traffic-control apply-timer \(1061\)](#)

snmp-server enable port-traps atc multicast-control-release This command sends a trap when multicast traffic falls beneath the lower threshold after a storm control response has been triggered and the release timer expires. Use the **no** form to disable this trap.

SYNTAX

```
[no] snmp-server enable port-traps atc  
multicast-control-release
```

DEFAULT SETTING

Disabled

COMMAND MODE

Interface Configuration (Ethernet)

EXAMPLE

```
Console(config)#interface ethernet 1/1  
Console(config-if)#snmp-server enable port-traps atc multicast-control-  
release  
Console(config-if)#
```

RELATED COMMANDS

[auto-traffic-control alarm-clear-threshold \(1064\)](#)

[auto-traffic-control action \(1063\)](#)

[auto-traffic-control release-timer \(1062\)](#)

ATC Display Commands

show auto-traffic-control This command shows global configuration settings for automatic storm control.

COMMAND MODE

Privileged Exec

EXAMPLE

```
Console#show auto-traffic-control  
  
Storm-control: Broadcast  
Apply-timer (sec) : 300  
release-timer (sec) : 900  
  
Storm-control: Multicast  
Apply-timer(sec) : 300  
release-timer(sec) : 900  
Console#
```

show auto-traffic-control interface This command shows interface configuration settings and storm control status for the specified port.

SYNTAX

show auto-traffic-control interface [*interface*]

interface

ethernet *unit/port*

unit - Unit identifier. (Range: 1)

port - Port number. (Range: 1-28/52)

COMMAND MODE

Privileged Exec

EXAMPLE

```
Console#show auto-traffic-control interface ethernet 1/1
Eth 1/1 Information
-----
Storm Control:          Broadcast          Multicast
State:                  Disabled          Disabled
Action:                 rate-control      rate-control
Auto Release Control:   Disabled          Disabled
Alarm Fire Threshold(Kpps): 128                128
Alarm Clear Threshold(Kpps):128                128
Trap Storm Fire:        Disabled          Disabled
Trap Storm Clear:       Disabled          Disabled
Trap Traffic Apply:     Disabled          Disabled
Trap Traffic Release:   Disabled          Disabled

Console#
```

The switch can be configured to detect general loopback conditions caused by hardware problems or faulty protocol settings. When enabled, a control frame is transmitted on the participating ports, and the switch monitors inbound traffic to see if the frame is looped back.

Table 132: Loopback Detection Commands

Command	Function	Mode
<code>loopback-detection</code>	Enables loopback detection globally on the switch or on a specified interface	GC, IC
<code>loopback-detection action</code>	Specifies the response to take for a detected loopback condition	GC
<code>loopback-detection recover-time</code>	Specifies the interval to wait before releasing an interface from shutdown state	GC
<code>loopback-detection transmit-interval</code>	Specifies the interval at which to transmit loopback detection control frames	GC
<code>loopback detection trap</code>	Configures the switch to send a trap when a loopback condition is detected or the switch recover from a loopback	GC
<code>loopback-detection release</code>	Manually releases all interfaces currently shut down by the loopback detection feature	PE
<code>show loopback-detection</code>	Shows loopback detection configuration settings for the switch or for a specified interface	PE

USAGE GUIDELINES

- ◆ The default settings for the control frame transmit interval and recover time may be adjusted to improve performance for your specific environment. The shutdown mode may also need to be changed once you determine what kind of packets are being looped back.
- ◆ General loopback detection provided by the command described in this section and loopback detection provided by the spanning tree protocol cannot both be enabled at the same time. If loopback detection is enabled for the spanning tree protocol, general loopback detection cannot be enabled on the same interface.
- ◆ When a loopback event is detected on an interface or when an interface is released from a shutdown state caused by a loopback event, a trap message is sent and the event recorded in the system log.
- ◆ Loopback detection must be enabled both globally and on an interface for loopback detection to take effect.

loopback-detection This command enables loopback detection globally on the switch or on a specified interface. Use the **no** form to disable loopback detection.

SYNTAX

[no] loopback-detection

DEFAULT SETTING

Disabled

COMMAND MODE

Global Configuration

Interface Configuration (Ethernet, Port Channel)

COMMAND USAGE

Loopback detection must be enabled globally for the switch by this command and enabled for a specific interface for this function to take effect.

EXAMPLE

This example enables general loopback detection on the switch, disables loopback detection provided for the spanning tree protocol on port 1, and then enables general loopback detection for that port.

```
Console(config)#loopback-detection
Console(config)#interface ethernet 1/1
Console(config-if)#no spanning-tree loopback-detection
Console(config-if)#loopback-detection
Console(config)#
```

loopback-detection action This command specifies the protective action the switch takes when a loopback condition is detected. Use the **no** form to restore the default setting. Use the **no** form to restore the default setting.

SYNTAX

loopback-detection action {block | none | shutdown}

no loopback-detection action

block - When a loopback is detected on a port which a member of a specific VLAN, packets belonging to that VLAN are dropped at the offending port.

none - No action is taken.

shutdown - Shuts down the interface.

DEFAULT SETTING

Shut down

COMMAND MODE

Global Configuration

COMMAND USAGE

- ◆ When the response to a detected loopback condition is set to block user traffic, loopback detection control frames may untagged or tagged depending on the port's VLAN membership type.
- ◆ When the response to a detected loopback condition is set to block user traffic, ingress filtering for the port is enabled automatically if not already enabled by the [switchport ingress-filtering](#) command. The port's original setting for ingress filtering will be restored when loopback detection is disabled.
- ◆ Use the [loopback-detection recover-time](#) command to set the time to wait before re-enabling an interface shut down by the loopback detection process.
- ◆ When the loopback detection response is changed, any ports placed in shutdown state by the loopback detection process will be immediately restored to operation regardless of the remaining recover time.

EXAMPLE

This example sets the loopback detection mode to block user traffic.

```
Console(config)#loopback-detection action block
Console(config)#
```

**loopback-detection
recover-time**

This command specifies the interval to wait before the switch automatically releases an interface from shutdown state. Use the **no** form to restore the default setting.

SYNTAX

loopback-detection recover-time *seconds*

no loopback-detection recover-time

seconds - Recovery time from shutdown state.

(Range: 60-1,000,000 seconds, or 0 to disable automatic recovery)

DEFAULT SETTING

60 seconds

COMMAND MODE

Global Configuration

COMMAND USAGE

- ◆ When the loopback detection mode is changed, any ports placed in shutdown state by the loopback detection process will be immediately restored to operation regardless of the remaining recover time.
- ◆ If the recovery time is set to zero, all ports placed in shutdown state can be restored to operation using the [loopback-detection release](#) command. To restore a specific port, use the [no shutdown](#) command.

EXAMPLE

```
Console(config)#loopback-detection recover-time 120
Console(config-if)#
```

loopback-detection transmit-interval This command specifies the interval at which to transmit loopback detection control frames. Use the **no** form to restore the default setting.

SYNTAX

loopback-detection transmit-interval *seconds*

no loopback-detection transmit-interval

seconds - The transmission interval for loopback detection control frames. (Range: 1-32767 seconds)

DEFAULT SETTING

10 seconds

COMMAND MODE

Global Configuration

EXAMPLE

```
Console(config)#loopback-detection transmit-interval 60
Console(config)#
```

loopback detection trap This command sends a trap when a loopback condition is detected, or when the switch recovers from a loopback condition. Use the **no** form to restore the default state.

SYNTAX

loopback-detection trap [**both** | **detect** | **none** | **recover**]

no loopback-detection trap

both - Sends an SNMP trap message when a loopback condition is detected, or when the switch recovers from a loopback condition.

detect - Sends an SNMP trap message when a loopback condition is detected.

none - Does not send an SNMP trap for loopback detection or recovery.

recover - Sends an SNMP trap message when the switch recovers from a loopback condition.

DEFAULT SETTING

None

COMMAND MODE

Global Configuration

COMMAND USAGE

Refer to the [loopback-detection recover-time](#) command for information on conditions which constitute loopback recovery.

EXAMPLE

```
Console(config)#loopback-detection trap both
Console(config)#
```

loopback-detection release This command releases all interfaces currently shut down by the loopback detection feature.

SYNTAX

loopback-detection release

COMMAND MODE

Privileged Exec

EXAMPLE

```
Console#loopback-detection release
Console(config)#
```

show loopback-detection This command shows loopback detection configuration settings for the switch or for a specified interface.

SYNTAX

show loopback-detection [*interface*]

interface

ethernet *unit/port*

unit - Unit identifier. (Range: 1)

port - Port number. (Range: 1-28/52)

COMMAND MODE

Privileged Exec

EXAMPLE

```
Console#show loopback-detection
Loopback Detection Global Information
Global Status      : Enabled
Transmit Interval : 10
Recover Time      : 60
Action            : Shutdown
```

```
Trap : None
Loopback Detection Port Information
Port      Admin State Oper State
-----
Eth 1/ 1  Enabled     Normal
Eth 1/ 2  Disabled    Disabled
Eth 1/ 3  Disabled    Disabled
:
Console#show loopback-detection ethernet 1/1
Loopback Detection Information of Eth 1/1
Admin State : Enabled
Oper State  : Normal
Looped VLAN : None
Console#
```

UNIDIRECTIONAL LINK DETECTION COMMANDS

The switch can be configured to detect and disable unidirectional Ethernet fiber or copper links. When enabled, the protocol advertises a port's identity and learns about its neighbors on a specific LAN segment; and stores information about its neighbors in a cache. It can also send out a train of echo messages under circumstances that require fast notifications or re-synchronization of the cached information.

Table 133: UniDirectional Link Detection Commands

Command	Function	Mode
<code>udld message-interval</code>	Configures the message interval between UDLD probe messages	GC
<code>udld aggressive</code>	Sets UDLD to aggressive mode on an interface	IC
<code>udld port</code>	Enables UDLD on an interface	IC
<code>show udld</code>	Shows UDLD configuration settings and operational status	PE

udld message-interval

This command configures the message interval between UDLD probe messages for ports in advertisement phase and determined to be bidirectional. Use the **no** form to restore the default setting.

SYNTAX

udld message-interval *message-interval*

no message-interval

message-interval – The interval at which a port sends UDLD probe messages after linkup or detection phases. (Range: 7-90 seconds)

DEFAULT SETTING

15 seconds

COMMAND MODE

Global Configuration

COMMAND USAGE

During the detection phase, messages are exchanged at the maximum rate of one per second. After that, if the protocol reaches a stable state and determines that the link is bidirectional, the message interval is increased to a configurable value based on a curve known as M1(t), a time-based function described in RFC 5171.

If the link is deemed anything other than bidirectional at the end of the detection phase, this curve becomes a flat line with a fixed value of Mfast (7 seconds).

If the link is instead deemed bidirectional, the curve will use Mfast for the first four subsequent message transmissions and then transition to an Mslow value for all other steady-state transmissions. Mslow is the value configured by this command.

EXAMPLE

This example sets the message interval to 10 seconds.

```
Console(config)#udld message-interval 10
Console(config)#
```

udld aggressive This command sets UDLD to aggressive mode on an interface. Use the **no** form to restore the default setting.

SYNTAX

[no] udld aggressive

DEFAULT SETTING

Disabled

COMMAND MODE

Interface Configuration (Ethernet Port)

COMMAND USAGE

UDLD can function in two modes: normal mode and aggressive mode.

- ◆ In normal mode, determination of link status at the end of the detection process is always based on information received in UDLD messages: whether that's information about the exchange of proper neighbor identification or the absence of such. Hence, albeit bound by a timer, normal mode determinations are always based on gleaned information, and as such are "event-based." If no such information can be obtained (e.g., because of a bidirectional loss of connectivity), UDLD follows a conservative approach minimize false positives during the detection process and deems a port to be in "undetermined" state. In other words, normal mode will shut down a port only if it can explicitly determine that the associated link is faulty for an extended period of time.
- ◆ In aggressive mode, UDLD will also shut down a port if it loses bidirectional connectivity with the neighbor for the same extended period of time (as that mentioned above for normal mode) and subsequently fails repeated last-resort attempts to re-establish communication with the other end of the link. This mode of operation assumes that loss of communication with the neighbor is a meaningful network event in itself, and a symptom of a serious connectivity

problem. Because this type of detection can be event-less, and lack of information cannot always be associated to an actual malfunction of the link, this mode is optional and is recommended only in certain scenarios (typically only on point-to-point links where no communication failure between two neighbors is admissible).

EXAMPLE

This example enables UDLD aggressive mode on port 1.

```
Console(config)#interface ethernet 1/1
Console(config-if)#udld aggressive
Console(config-if)#
```

udld port This command enables UDLD on an interface. Use the **no** form to disable UDLD on an interface.

SYNTAX

[no] udld port

DEFAULT SETTING

Disabled

COMMAND MODE

Interface Configuration (Ethernet Port)

COMMAND USAGE

- ◆ UDLD requires that all the devices connected to the same LAN segment be running the protocol in order for a potential mis-configuration to be detected and for prompt corrective action to be taken.
- ◆ Whenever a UDLD device learns about a new neighbor or receives a re-synchronization request from an out-of-synch neighbor, it (re)starts the detection process on its side of the connection and sends N echo messages in reply. (This mechanism implicitly assumes that N packets are sufficient to get through a link and reach the other end, even though some of them might get dropped during the transmission.)

Since this behavior must be the same on all the neighbors, the sender of the echoes expects to receive an echo in reply. If the detection process ends without the proper echo information being received, the link is considered to be unidirectional.

EXAMPLE

```
Console(config)#interface ethernet 1/1
Console(config-if)#udld port
Console(config-if)#
```

show uddl This command shows UDLD configuration settings and operational status for the switch or for a specified interface.

SYNTAX

```
show uddl [interface interface]
           interface
           ethernet unit/port
           unit - Unit identifier. (Range: 1)
           port - Port number. (Range: 1-28/52)
```

COMMAND MODE

Privileged Exec

EXAMPLE

```
Console#show uddl
Message Interval : 15

Interface UDLD      Mode      Oper State      Msg Invl
-----
Eth 1/ 1  Enabled  Aggressive  Advertisement    15 s
                               Bidirectional    5 s
Eth 1/ 2  Disabled Normal      Disabled         7 s
                               Unknown          5 s
Eth 1/ 3  Disabled Normal      Disabled         7 s
                               Unknown          5 s
Eth 1/ 4  Disabled Normal      Disabled         7 s
                               Unknown          5 s
Eth 1/ 5  Disabled Normal      Disabled         7 s
                               Unknown          5 s
:
Console#show uddl interface ethernet 1/1
Interface UDLD      Mode      Oper State      Msg Invl
-----
Eth 1/ 1  Enabled  Aggressive  Advertisement    15 s
                               Bidirectional    5 s
Console#
```

Table 134: show uddl - display description

Field	Description
Message Interval	The interval between UDLD probe messages for ports in advertisement phase
UDLD	Shows if UDLD is enabled or disabled on a port
Mode	Shows if UDLD is functioning in Normal or Aggressive mode
Oper State	Shows the UDLD operational state (Disabled, Link down, Link up, Advertisement, Detection, Disabled port, Advertisement - Single neighbor, Advertisement - Multiple neighbors)

Table 134: show uddl - display description (Continued)

Field	Description
Port State	Shows the UDLD port state (Unknown, Bidirectional, Unidirectional, Transmit-to-receive loop, Mismatch with neighbor state reported, Neighbor's echo is empty) The state is Unknown if the link is down or not connected to a UDLD-capable device. The state is Bidirectional if the link has a normal two-way connection to a UDLD-capable device. All other states indicate miswiring.
Msg Invl	The interval between UDLD probe messages used for the indicated operational state
Timeout	The time that UDLD waits for echoes from a neighbor device during the detection window

These commands are used to configure the address table for filtering specified addresses, displaying current entries, clearing the table, or setting the aging time.

Table 135: Address Table Commands

Command	Function	Mode
<code>mac-address-table aging-time</code>	Sets the aging time of the address table	GC
<code>mac-address-table static</code>	Maps a static address to a port in a VLAN	GC
<code>clear mac-address-table dynamic</code>	Removes any learned entries from the forwarding database	PE
<code>show mac-address-table</code>	Displays entries in the bridge-forwarding database	PE
<code>show mac-address-table aging-time</code>	Shows the aging time for the address table	PE
<code>show mac-address-table count</code>	Shows the number of MAC addresses used and the number of available MAC addresses	PE

mac-address-table aging-time This command sets the aging time for entries in the address table. Use the **no** form to restore the default aging time.

SYNTAX

mac-address-table aging-time *seconds*

no mac-address-table aging-time

seconds - Aging time. (Range: 10-844 seconds; 0 to disable aging)

DEFAULT SETTING

300 seconds

COMMAND MODE

Global Configuration

COMMAND USAGE

The aging time is used to age out dynamically learned forwarding information.

EXAMPLE

```
Console(config)#mac-address-table aging-time 100
Console(config)#
```

mac-address-table static This command maps a static address to a destination port in a VLAN. Use the **no** form to remove an address.

SYNTAX

mac-address-table static *mac-address* **interface** *interface*
vlan *vlan-id* [*action*]

no mac-address-table static *mac-address* **vlan** *vlan-id*

mac-address - MAC address.

interface

ethernet *unit/port*

unit - Unit identifier. (Range: 1)

port - Port number. (Range: 1-28/52)

port-channel *channel-id* (Range: 1-16)

vlan-id - VLAN ID (Range: 1-4094)

action -

delete-on-reset - Assignment lasts until the switch is reset.

permanent - Assignment is permanent.

DEFAULT SETTING

No static addresses are defined. The default mode is **permanent**.

COMMAND MODE

Global Configuration

COMMAND USAGE

The static address for a host device can be assigned to a specific port within a specific VLAN. Use this command to add static addresses to the MAC Address Table. Static addresses have the following characteristics:

- ◆ Static addresses will not be removed from the address table when a given interface link is down.
- ◆ Static addresses are bound to the assigned interface and will not be moved. When a static address is seen on another interface, the address will be ignored and will not be written to the address table.
- ◆ A static address cannot be learned on another port until the address is removed with the **no** form of this command.

EXAMPLE

```

Console(config)#mac-address-table static 00-e0-29-94-34-de interface ethernet
1/1 vlan 1 delete-on-reset
Console(config)#

```

clear mac-address-table dynamic This command removes any learned entries from the forwarding database.

DEFAULT SETTING

None

COMMAND MODE

Privileged Exec

EXAMPLE

```

Console#clear mac-address-table dynamic
Console#

```

show mac-address-table This command shows classes of entries in the bridge-forwarding database.

SYNTAX

```

show mac-address-table [address mac-address [mask]]
[interface interface] [vlan vlan-id]
[sort {address | vlan | interface}]

```

mac-address - MAC address.

mask - Bits to match in the address.

interface

ethernet *unit/port*

unit - Unit identifier. (Range: 1)

port - Port number. (Range: 1-28/52)

port-channel *channel-id* (Range: 1-16)

vlan-id - VLAN ID (Range: 1-4094)

sort - Sort by address, vlan or interface.

DEFAULT SETTING

None

COMMAND MODE

Privileged Exec

COMMAND USAGE

- ◆ The MAC Address Table contains the MAC addresses associated with each interface. Note that the Type field may include the following types:
 - Learn - Dynamic address entries
 - Config - Static entry
- ◆ The mask should be hexadecimal numbers (representing an equivalent bit mask) in the form xx-xx-xx-xx-xx-xx that is applied to the specified MAC address. Enter hexadecimal numbers, where an equivalent binary bit "0" means to match a bit and "1" means to ignore a bit. For example, a mask of 00-00-00-00-00-00 means an exact match, and a mask of FF-FF-FF-FF-FF-FF means "any."
- ◆ The maximum number of address entries is 16K.

EXAMPLE

```

Console#show mac-address-table
Interface MAC Address      VLAN Type      Life Time
-----
CPU       B4-0E-DC-34-96-08      1 CPU      Delete on Reset
Eth 1/ 1 00-E0-29-94-34-DE 1 Config   Delete on Reset
Eth 1/21 00-01-EC-F8-D8-D9 1 Learn    Delete on Timeout
Console#

```

show mac-address-table aging-time This command shows the aging time for entries in the address table.

DEFAULT SETTING

None

COMMAND MODE

Privileged Exec

EXAMPLE

```

Console#show mac-address-table aging-time
Aging Status : Enabled
Aging Time: 300 sec.
Console#

```

show mac-address-table count This command shows the number of MAC addresses used and the number of available MAC addresses for the overall system or for an interface.

SYNTAX

show mac-address-table count interface *interface*

interface

ethernet *unit/port*

unit - Unit identifier. (Range: 1)

port - Port number. (Range: 1-28/52)

port-channel *channel-id* (Range: 1-16)

DEFAULT SETTING

None

COMMAND MODE

Privileged Exec

EXAMPLE

```
Console#show mac-address-table count interface ethernet 1/13
MAC Entries for Eth 1/13
Total Address Count      :1
Static Address Count     :0
Dynamic Address Count    :1
Console#
```

This section includes commands that configure the Spanning Tree Algorithm (STA) globally for the switch, and commands that configure STA for the selected interface.

Table 136: Spanning Tree Commands

Command	Function	Mode
<code>spanning-tree</code>	Enables the spanning tree protocol	GC
<code>spanning-tree cisco-prestandard</code>	Configures spanning tree operation to be compatible with Cisco prestandard versions	GC
<code>spanning-tree forward-time</code>	Configures the spanning tree bridge forward time	GC
<code>spanning-tree hello-time</code>	Configures the spanning tree bridge hello time	GC
<code>spanning-tree max-age</code>	Configures the spanning tree bridge maximum age	GC
<code>spanning-tree mode</code>	Configures STP, RSTP or MSTP mode	GC
<code>spanning-tree pathcost method</code>	Configures the path cost method for RSTP/MSTP	GC
<code>spanning-tree priority</code>	Configures the spanning tree bridge priority	GC
<code>spanning-tree mst configuration</code>	Changes to MSTP configuration mode	GC
<code>spanning-tree system-bpdu-flooding</code>	Floods BPDUs to all other ports or just to all other ports in the same VLAN when global spanning tree is disabled	GC
<code>spanning-tree transmission-limit</code>	Configures the transmission limit for RSTP/MSTP	GC
<code>max-hops</code>	Configures the maximum number of hops allowed in the region before a BPDU is discarded	MST
<code>mst priority</code>	Configures the priority of a spanning tree instance	MST
<code>mst vlan</code>	Adds VLANs to a spanning tree instance	MST
<code>name</code>	Configures the name for the multiple spanning tree	MST
<code>revision</code>	Configures the revision number for the multiple spanning tree	MST
<code>spanning-tree bpdu-filter</code>	Filters BPDUs for edge ports	IC
<code>spanning-tree bpdu-guard</code>	Shuts down an edge port if it receives a BPDU	IC
<code>spanning-tree cost</code>	Configures the spanning tree path cost of an interface	IC
<code>spanning-tree edge-port</code>	Enables fast forwarding for edge ports	IC
<code>spanning-tree link-type</code>	Configures the link type for RSTP/MSTP	IC
<code>spanning-tree loopback-detection</code>	Enables BPDU loopback detection for a port	IC
<code>spanning-tree loopback-detection action</code>	Configures the response for loopback detection to block user traffic or shut down the interface	IC

Table 136: Spanning Tree Commands (Continued)

Command	Function	Mode
<code>spanning-tree loopback-detection release-mode</code>	Configures loopback release mode for a port	IC
<code>spanning-tree loopback-detection trap</code>	Enables BPDU loopback SNMP trap notification for a port	IC
<code>spanning-tree mst cost</code>	Configures the path cost of an instance in the MST	IC
<code>spanning-tree mst port-priority</code>	Configures the priority of an instance in the MST	IC
<code>spanning-tree port-bpdu-flooding</code>	Floods BPDUs to other ports when global spanning tree is disabled	IC
<code>spanning-tree port-priority</code>	Configures the spanning tree priority of an interface	IC
<code>spanning-tree root-guard</code>	Prevents a designated port from passing superior BPDUs	IC
<code>spanning-tree spanning-disabled</code>	Disables spanning tree for an interface	IC
<code>spanning-tree tc-prop-stop</code>	Stops propagation of topology change information	IC
<code>spanning-tree loopback-detection release</code>	Manually releases a port placed in discarding state by loopback-detection	PE
<code>spanning-tree protocol-migration</code>	Re-checks the appropriate BPDU format	PE
<code>show spanning-tree</code>	Shows spanning tree configuration for the common spanning tree (i.e., overall bridge), a selected interface, or an instance within the multiple spanning tree	PE
<code>show spanning-tree mst configuration</code>	Shows the multiple spanning tree configuration	PE

spanning-tree This command enables the Spanning Tree Algorithm globally for the switch. Use the **no** form to disable it.

SYNTAX

[no] spanning-tree

DEFAULT SETTING

Spanning tree is enabled.

COMMAND MODE

Global Configuration

COMMAND USAGE

The Spanning Tree Algorithm (STA) can be used to detect and disable network loops, and to provide backup links between switches, bridges or routers. This allows the switch to interact with other bridging devices (that is, an STA-compliant switch, bridge or router) in your network to ensure that only one route exists between any two stations on the network, and provide backup links which automatically take over when a primary link goes down.

EXAMPLE

This example shows how to enable the Spanning Tree Algorithm for the switch:

```
Console(config)#spanning-tree
Console(config)#
```

**spanning-tree
cisco-prestandard**

This command configures spanning tree operation to be compatible with Cisco prestandard versions. Use the **no** form to restore the default setting.

[no] spanning-tree cisco-prestandard

DEFAULT SETTING

Disabled

COMMAND MODE

Global Configuration

COMMAND USAGE

Cisco prestandard versions prior to Cisco IOS Release 12.2(25)SEC do not fully follow the IEEE standard, causing some state machine procedures to function incorrectly. The command forces the spanning tree protocol to function in a manner compatible with Cisco prestandard versions.

EXAMPLE

```
Console(config)#spanning-tree cisco-prestandard
Console(config)#
```

**spanning-tree
forward-time**

This command configures the spanning tree bridge forward time globally for this switch. Use the **no** form to restore the default.

SYNTAX

spanning-tree forward-time *seconds*

no spanning-tree forward-time

seconds - Time in seconds. (Range: 4 - 30 seconds)

The minimum value is the higher of 4 or $[(\text{max-age} / 2) + 1]$.

DEFAULT SETTING

15 seconds

COMMAND MODE

Global Configuration

COMMAND USAGE

This command sets the maximum time (in seconds) a port will wait before changing states (i.e., discarding to learning to forwarding). This delay is required because every device must receive information about topology changes before it starts to forward frames. In addition, each port needs time to listen for conflicting information that would make it return to the discarding state; otherwise, temporary data loops might result.

EXAMPLE

```
Console(config)#spanning-tree forward-time 20
Console(config)#
```

spanning-tree hello-time This command configures the spanning tree bridge hello time globally for this switch. Use the **no** form to restore the default.

SYNTAX

spanning-tree hello-time *time*

no spanning-tree hello-time

time - Time in seconds. (Range: 1-10 seconds).

The maximum value is the lower of 10 or $[(\text{max-age} / 2) - 1]$.

DEFAULT SETTING

2 seconds

COMMAND MODE

Global Configuration

COMMAND USAGE

This command sets the time interval (in seconds) at which the root device transmits a configuration message.

EXAMPLE

```
Console(config)#spanning-tree hello-time 5
Console(config)#
```

RELATED COMMANDS

[spanning-tree forward-time \(1093\)](#)

[spanning-tree max-age \(1095\)](#)

spanning-tree max-age This command configures the spanning tree bridge maximum age globally for this switch. Use the **no** form to restore the default.

SYNTAX

spanning-tree max-age *seconds*

no spanning-tree max-age

seconds - Time in seconds. (Range: 6-40 seconds)

The minimum value is the higher of 6 or [2 x (hello-time + 1)].

The maximum value is the lower of 40 or [2 x (forward-time - 1)].

DEFAULT SETTING

20 seconds

COMMAND MODE

Global Configuration

COMMAND USAGE

This command sets the maximum time (in seconds) a device can wait without receiving a configuration message before attempting to reconverge. All device ports (except for designated ports) should receive configuration messages at regular intervals. Any port that ages out STA information (provided in the last configuration message) becomes the designated port for the attached LAN. If it is a root port, a new root port is selected from among the device ports attached to the network.

EXAMPLE

```
Console(config)#spanning-tree max-age 40
Console(config)#
```

RELATED COMMANDS

[spanning-tree forward-time \(1093\)](#)

[spanning-tree hello-time \(1094\)](#)

spanning-tree mode This command selects the spanning tree mode for this switch. Use the **no** form to restore the default.

SYNTAX

spanning-tree mode {**stp** | **rstp** | **mstp**}

no spanning-tree mode

stp - Spanning Tree Protocol (IEEE 802.1D)

rstp - Rapid Spanning Tree Protocol (IEEE 802.1w)

mstp - Multiple Spanning Tree (IEEE 802.1s)

DEFAULT SETTING

rstp

COMMAND MODE

Global Configuration

COMMAND USAGE

- ◆ **Spanning Tree Protocol**
This option uses RSTP set to STP forced compatibility mode. It uses RSTP for the internal state machine, but sends only 802.1D BPDUs. This creates one spanning tree instance for the entire network. If multiple VLANs are implemented on a network, the path between specific VLAN members may be inadvertently disabled to prevent network loops, thus isolating group members. When operating multiple VLANs, we recommend selecting the MSTP option.
- ◆ **Rapid Spanning Tree Protocol**
RSTP supports connections to either STP or RSTP nodes by monitoring the incoming protocol messages and dynamically adjusting the type of protocol messages the RSTP node transmits, as described below:
 - **STP Mode** – If the switch receives an 802.1D BPDU after a port’s migration delay timer expires, the switch assumes it is connected to an 802.1D bridge and starts using only 802.1D BPDUs.
 - **RSTP Mode** – If RSTP is using 802.1D BPDUs on a port and receives an RSTP BPDU after the migration delay expires, RSTP restarts the migration delay timer and begins using RSTP BPDUs on that port.
- ◆ **Multiple Spanning Tree Protocol**
 - To allow multiple spanning trees to operate over the network, you must configure a related set of bridges with the same MSTP configuration, allowing them to participate in a specific set of spanning tree instances.
 - A spanning tree instance can exist only on bridges that have compatible VLAN instance assignments.
 - Be careful when switching between spanning tree modes. Changing modes stops all spanning-tree instances for the previous mode and restarts the system in the new mode, temporarily disrupting user traffic.

EXAMPLE

The following example configures the switch to use Rapid Spanning Tree:

```

Console(config)#spanning-tree mode rstp
Console(config)#

```

spanning-tree pathcost method This command configures the path cost method used for Rapid Spanning Tree and Multiple Spanning Tree. Use the **no** form to restore the default.

SYNTAX

spanning-tree pathcost method {**long** | **short**}

no spanning-tree pathcost method

long - Specifies 32-bit based values that range from 1-200,000,000. This method is based on the IEEE 802.1w Rapid Spanning Tree Protocol.

short - Specifies 16-bit based values that range from 1-65535. This method is based on the IEEE 802.1 Spanning Tree Protocol.

DEFAULT SETTING

Long method

COMMAND MODE

Global Configuration

COMMAND USAGE

- ◆ The path cost method is used to determine the best path between devices. Therefore, lower values should be assigned to ports attached to faster media, and higher values assigned to ports with slower media. Note that path cost ([page 1105](#)) takes precedence over port priority ([page 1112](#)).
- ◆ The path cost methods apply to all spanning tree modes (STP, RSTP and MSTP). Specifically, the long method can be applied to STP since this mode is supported by a backward compatible mode of RSTP.

EXAMPLE

```
Console(config)#spanning-tree pathcost method long
Console(config)#
```

spanning-tree priority This command configures the spanning tree priority globally for this switch. Use the **no** form to restore the default.

SYNTAX

spanning-tree priority *priority*

no spanning-tree priority

priority - Priority of the bridge. (Range – 0-61440, in steps of 4096; Options: 0, 4096, 8192, 12288, 16384, 20480, 24576, 28672, 32768, 36864, 40960, 45056, 49152, 53248, 57344, 61440)

DEFAULT SETTING

32768

COMMAND MODE

Global Configuration

COMMAND USAGE

Bridge priority is used in selecting the root device, root port, and designated port. The device with the highest priority (i.e., lower numeric value) becomes the STA root device. However, if all devices have the same priority, the device with the lowest MAC address will then become the root device.

EXAMPLE

```
Console(config)#spanning-tree priority 40000
Console(config)#
```

**spanning-tree
mst configuration**

This command changes to Multiple Spanning Tree (MST) configuration mode.

DEFAULT SETTING

No VLANs are mapped to any MST instance.
The region name is set the switch's MAC address.

COMMAND MODE

Global Configuration

EXAMPLE

```
Console(config)#spanning-tree mst configuration
Console(config-mstp)#
```

RELATED COMMANDS

[mst vlan \(1101\)](#)
[mst priority \(1100\)](#)
[name \(1102\)](#)
[revision \(1102\)](#)
[max-hops \(1100\)](#)

spanning-tree system-bpdu-flooding This command configures the system to flood BPDUs to all other ports on the switch or just to all other ports in the same VLAN when spanning tree is disabled globally on the switch or disabled on a specific port. Use the **no** form to restore the default.

SYNTAX

spanning-tree system-bpdu-flooding {**to-all** | **to-vlan**}

no spanning-tree system-bpdu-flooding

to-all - Floods BPDUs to all other ports on the switch.

to-vlan - Floods BPDUs to all other ports within the receiving port's native VLAN (i.e., as determined by port's PVID).

DEFAULT SETTING

Floods to all other ports in the same VLAN.

COMMAND MODE

Global Configuration

COMMAND USAGE

The **spanning-tree system-bpdu-flooding** command has no effect if BPDU flooding is disabled on a port (see the [spanning-tree port-bpdu-flooding](#) command).

EXAMPLE

```
Console(config)#spanning-tree system-bpdu-flooding
Console(config)#
```

spanning-tree transmission-limit This command configures the minimum interval between the transmission of consecutive RSTP/MSTP BPDUs. Use the **no** form to restore the default.

SYNTAX

spanning-tree transmission-limit *count*

no spanning-tree transmission-limit

count - The transmission limit in seconds. (Range: 1-10)

DEFAULT SETTING

3

COMMAND MODE

Global Configuration

COMMAND USAGE

This command limits the maximum transmission rate for BPDUs.

EXAMPLE

```
Console(config)#spanning-tree transmission-limit 4
Console(config)#
```

max-hops This command configures the maximum number of hops in the region before a BPDU is discarded. Use the **no** form to restore the default.

SYNTAX

max-hops *hop-number*

hop-number - Maximum hop number for multiple spanning tree.
(Range: 1-40)

DEFAULT SETTING

20

COMMAND MODE

MST Configuration

COMMAND USAGE

An MSTI region is treated as a single node by the STP and RSTP protocols. Therefore, the message age for BPDUs inside an MSTI region is never changed. However, each spanning tree instance within a region, and the internal spanning tree (IST) that connects these instances use a hop count to specify the maximum number of bridges that will propagate a BPDU. Each bridge decrements the hop count by one before passing on the BPDU. When the hop count reaches zero, the message is dropped.

EXAMPLE

```
Console(config-mstp)#max-hops 30
Console(config-mstp)#
```

mst priority This command configures the priority of a spanning tree instance. Use the **no** form to restore the default.

SYNTAX

mst *instance-id* **priority** *priority*

no mst *instance-id* **priority**

instance-id - Instance identifier of the spanning tree.
(Range: 0-4094)

priority - Priority of the a spanning tree instance.
(Range: 0-61440 in steps of 4096; Options: 0, 4096, 8192, 12288, 16384, 20480, 24576, 28672, 32768, 36864, 40960, 45056, 49152, 53248, 57344, 61440)

DEFAULT SETTING

32768

COMMAND MODE

MST Configuration

COMMAND USAGE

- ◆ MST priority is used in selecting the root bridge and alternate bridge of the specified instance. The device with the highest priority (i.e., lowest numerical value) becomes the MSTI root device. However, if all devices have the same priority, the device with the lowest MAC address will then become the root device.
- ◆ You can set this switch to act as the MSTI root device by specifying a priority of 0, or as the MSTI alternate device by specifying a priority of 16384.

EXAMPLE

```
Console(config-mstp)#mst 1 priority 4096
Console(config-mstp)#
```

mst vlan This command adds VLANs to a spanning tree instance. Use the **no** form to remove the specified VLANs. Using the **no** form without any VLAN parameters to remove all VLANs.

SYNTAX

[no] mst instance-id vlan vlan-range

instance-id - Instance identifier of the spanning tree.
(Range: 0-4094)

vlan-range - Range of VLANs. (Range: 1-4094)

DEFAULT SETTING

none

COMMAND MODE

MST Configuration

COMMAND USAGE

- ◆ Use this command to group VLANs into spanning tree instances. MSTP generates a unique spanning tree for each instance. This provides multiple pathways across the network, thereby balancing the traffic load, preventing wide-scale disruption when a bridge node in a single instance fails, and allowing for faster convergence of a new topology for the failed instance.
- ◆ By default all VLANs are assigned to the Internal Spanning Tree (MSTI 0) that connects all bridges and LANs within the MST region. This switch supports up to 16 instances. You should try to group VLANs

which cover the same general area of your network. However, remember that you must configure all bridges within the same MSTI Region ([page 1102](#)) with the same set of instances, and the same instance (on each bridge) with the same set of VLANs. Also, note that RSTP treats each MSTI region as a single node, connecting all regions to the Common Spanning Tree.

EXAMPLE

```
Console(config-mstp)#mst 1 vlan 2-5
Console(config-mstp)#
```

name This command configures the name for the multiple spanning tree region in which this switch is located. Use the **no** form to clear the name.

SYNTAX

name *name*

name - Name of the spanning tree.

DEFAULT SETTING

Switch's MAC address

COMMAND MODE

MST Configuration

COMMAND USAGE

The MST region name and revision number ([page 1102](#)) are used to designate a unique MST region. A bridge (i.e., spanning-tree compliant device such as this switch) can only belong to one MST region. And all bridges in the same region must be configured with the same MST instances.

EXAMPLE

```
Console(config-mstp)#name R&D
Console(config-mstp)#
```

RELATED COMMANDS

[revision \(1102\)](#)

revision This command configures the revision number for this multiple spanning tree configuration of this switch. Use the **no** form to restore the default.

SYNTAX

revision *number*

number - Revision number of the spanning tree. (Range: 0-65535)

DEFAULT SETTING

0

COMMAND MODE

MST Configuration

COMMAND USAGE

The MST region name ([page 1102](#)) and revision number are used to designate a unique MST region. A bridge (i.e., spanning-tree compliant device such as this switch) can only belong to one MST region. And all bridges in the same region must be configured with the same MST instances.

EXAMPLE

```
Console(config-mstp)#revision 1
Console(config-mstp)#
```

RELATED COMMANDS[name \(1102\)](#)

spanning-tree bpd-filter This command allows you to avoid transmitting BPDUs on configured edge ports that are connected to end nodes. Use the **no** form to disable this feature.

SYNTAX

[no] spanning-tree bpd-filter

DEFAULT SETTING

Disabled

COMMAND MODE

Interface Configuration (Ethernet, Port Channel)

COMMAND USAGE

- ◆ This command stops all Bridge Protocol Data Units (BPDUs) from being transmitted on configured edge ports to save CPU processing time. This function is designed to work in conjunction with edge ports which should only connect end stations to the switch, and therefore do not need to process BPDUs. However, note that if a trunking port connected to another switch or bridging device is mistakenly configured as an edge port, and BPDU filtering is enabled on this port, this might cause a loop in the spanning tree.
- ◆ Before enabling BPDU Filter, the interface must first be configured as an edge port with the [spanning-tree edge-port](#) command.

EXAMPLE

```

Console(config)#interface ethernet 1/5
Console(config-if)#spanning-tree edge-port
Console(config-if)#spanning-tree bpdu-filter
Console(config-if)#

```

RELATED COMMANDS

[spanning-tree edge-port \(1106\)](#)

**spanning-tree
bpdu-guard**

This command shuts down an edge port (i.e., an interface set for fast forwarding) if it receives a BPDU. Use the **no** form without any keywords to disable this feature, or with a keyword to restore the default settings.

Syntax

spanning-tree bpdu-guard [**auto-recovery** [**interval** *interval*]]

no spanning-tree bpdu-guard [**auto-recovery** [**interval**]]

auto-recovery - Automatically re-enables an interface after the specified interval.

interval - The time to wait before re-enabling an interface.
(Range: 30-86400 seconds)

DEFAULT SETTING

BPDU Guard: Disabled

Auto-Recovery: Disabled

Auto-Recovery Interval: 300 seconds

COMMAND MODE

Interface Configuration (Ethernet, Port Channel)

COMMAND USAGE

- ◆ An edge port should only be connected to end nodes which do not generate BPDUs. If a BPDU is received on an edge port, this indicates an invalid network configuration, or that the switch may be under attack by a hacker. If an interface is shut down by BPDU Guard, it must be manually re-enabled using the [no spanning-tree spanning-disabled](#) command if the auto-recovery interval is not specified.
- ◆ Before enabling BPDU Guard, the interface must be configured as an edge port with the [spanning-tree edge-port](#) command. Also note that if the edge port attribute is disabled on an interface, BPDU Guard will also be disabled on that interface.

EXAMPLE

```

Console(config)#interface ethernet 1/5
Console(config-if)#spanning-tree edge-port
Console(config-if)#spanning-tree bpdu-guard
Console(config-if)#

```

RELATED COMMANDS[spanning-tree edge-port \(1106\)](#)[spanning-tree spanning-disabled \(1114\)](#)

spanning-tree cost This command configures the spanning tree path cost for the specified interface. Use the **no** form to restore the default auto-configuration mode.

SYNTAX**spanning-tree cost** *cost***no spanning-tree cost**

cost - The path cost for the port. (Range: 0 for auto-configuration, 1-65535 for short path cost method, 1-200,000,000 for long path cost method)²⁷

Table 137: Recommended STA Path Cost Range

Port Type	Short Path Cost (IEEE 802.1D-1998)	Long Path Cost (IEEE 802.1D-2004)
Ethernet	50-600	200,000-20,000,000
Fast Ethernet	10-60	20,000-2,000,000
Gigabit Ethernet	3-10	2,000-200,000

DEFAULT SETTING

By default, the system automatically detects the speed and duplex mode used on each port, and configures the path cost according to the values shown below. Path cost "0" is used to indicate auto-configuration mode. When the short path cost method is selected and the default path cost recommended by the IEEE 8021w standard exceeds 65,535, the default is set to 65,535.

Table 138: Default STA Path Costs

Port Type	Short Path Cost (IEEE 802.1D-1998)	Long Path Cost (IEEE 802.1D-2004)
Ethernet	65,535	1,000,000
Fast Ethernet	65,535	100,000
Gigabit Ethernet	10,000	10,000

COMMAND MODE

Interface Configuration (Ethernet, Port Channel)

27. Use the [spanning-tree pathcost method](#) command to set the path cost method. The range displayed in the CLI prompt message shows the maximum value for path cost. However, note that the switch still enforces the rules for path cost based on the specified path cost method (long or short).

COMMAND USAGE

- ◆ This command is used by the Spanning Tree Algorithm to determine the best path between devices. Therefore, lower values should be assigned to ports attached to faster media, and higher values assigned to ports with slower media.
- ◆ Path cost takes precedence over port priority.
- ◆ When the path cost method ([page 1097](#)) is set to short, the maximum value for path cost is 65,535.

EXAMPLE

```
Console(config)#interface ethernet 1/5
Console(config-if)#spanning-tree cost 50
Console(config-if)#
```

spanning-tree edge-port This command specifies an interface as an edge port. Use the **no** form to restore the default.

SYNTAX

spanning-tree edge-port [auto]

no spanning-tree edge-port

auto - Automatically determines if an interface is an edge port.

DEFAULT SETTING

Auto

COMMAND MODE

Interface Configuration (Ethernet, Port Channel)

COMMAND USAGE

You can enable this option if an interface is attached to a LAN segment that is at the end of a bridged LAN or to an end node. Since end nodes cannot cause forwarding loops, they can pass directly through to the spanning tree forwarding state. Specifying Edge Ports provides quicker convergence for devices such as workstations or servers, retains the current forwarding database to reduce the amount of frame flooding required to rebuild address tables during reconfiguration events, does not cause the spanning tree to initiate reconfiguration when the interface changes state, and also overcomes other STA-related time out problems. However, remember that Edge Port should only be enabled for ports connected to an end-node device.

EXAMPLE

```
Console(config)#interface ethernet 1/5
Console(config-if)#spanning-tree edge-port
Console(config-if)#
```

spanning-tree link-type This command configures the link type for Rapid Spanning Tree and Multiple Spanning Tree. Use the **no** form to restore the default.

SYNTAX

spanning-tree link-type {**auto** | **point-to-point** | **shared**}

no spanning-tree link-type

auto - Automatically derived from the duplex mode setting.

point-to-point - Point-to-point link.

shared - Shared medium.

DEFAULT SETTING

auto

COMMAND MODE

Interface Configuration (Ethernet, Port Channel)

COMMAND USAGE

- ◆ Specify a point-to-point link if the interface can only be connected to exactly one other bridge, or a shared link if it can be connected to two or more bridges.
- ◆ When automatic detection is selected, the switch derives the link type from the duplex mode. A full-duplex interface is considered a point-to-point link, while a half-duplex interface is assumed to be on a shared link.
- ◆ RSTP only works on point-to-point links between two bridges. If you designate a port as a shared link, RSTP is forbidden. Since MSTP is an extension of RSTP, this same restriction applies.

EXAMPLE

```
Console(config)#interface ethernet 1/5
Console(config-if)#spanning-tree link-type point-to-point
```

spanning-tree loopback-detection This command enables the detection and response to Spanning Tree loopback BPDU packets on the port. Use the **no** form to disable this feature.

SYNTAX

[no] spanning-tree loopback-detection

DEFAULT SETTING

Enabled

COMMAND MODE

Interface Configuration (Ethernet, Port Channel)

COMMAND USAGE

- ◆ If Port Loopback Detection is not enabled and a port receives its own BPDU, then the port will drop the loopback BPDU according to IEEE Standard 802.1W-2001 9.3.4 (Note 1).
- ◆ Port Loopback Detection will not be active if Spanning Tree is disabled on the switch.

EXAMPLE

```
Console(config)#interface ethernet 1/5
Console(config-if)#spanning-tree loopback-detection
```

spanning-tree loopback-detection action

This command configures the response for loopback detection to block user traffic or shut down the interface. Use the **no** form to restore the default.

SYNTAX**spanning-tree loopback-detection action**

{**block** | **shutdown** *duration*}

no spanning-tree loopback-detection action

block - Blocks user traffic.

shutdown - Shuts down the interface.

duration - The duration to shut down the interface.
(Range: 60-86400 seconds)

DEFAULT SETTING

block

COMMAND MODE

Interface Configuration (Ethernet, Port Channel)

COMMAND USAGE

- ◆ If an interface is shut down by this command, and the release mode is set to "auto" with the [spanning-tree loopback-detection release-mode](#) command, the selected interface will be automatically enabled when the shutdown interval has expired.
- ◆ If an interface is shut down by this command, and the release mode is set to "manual," the interface can be re-enabled using the [spanning-tree loopback-detection release](#) command.

EXAMPLE

```
Console(config)#interface ethernet 1/5
Console(config-if)#spanning-tree loopback-detection action shutdown 600
Console(config-if)#
```

spanning-tree loopback-detection release-mode This command configures the release mode for a port that was placed in the discarding state because a loopback BPDU was received. Use the **no** form to restore the default.

SYNTAX

spanning-tree loopback-detection release-mode
{**auto** | **manual**}

no spanning-tree loopback-detection release-mode

auto - Allows a port to automatically be released from the discarding state when the loopback state ends.

manual - The port can only be released from the discarding state manually.

DEFAULT SETTING

auto

COMMAND MODE

Interface Configuration (Ethernet, Port Channel)

COMMAND USAGE

- ◆ If the port is configured for automatic loopback release, then the port will only be returned to the forwarding state if one of the following conditions is satisfied:
 - The port receives any other BPDU except for its own, or;
 - The port's link status changes to link down and then link up again, or;
 - The port ceases to receive its own BPDUs in a forward delay interval.
- ◆ If Port Loopback Detection is not enabled and a port receives its own BPDU, then the port will drop the loopback BPDU according to IEEE Standard 802.1W-2001 9.3.4 (Note 1).
- ◆ Port Loopback Detection will not be active if Spanning Tree is disabled on the switch.
- ◆ When configured for manual release mode, then a link down / up event will not release the port from the discarding state. It can only be released using the [spanning-tree loopback-detection release](#) command.

EXAMPLE

```
Console(config)#interface ethernet 1/5
Console(config-if)#spanning-tree loopback-detection release-mode manual
Console(config-if)#
```

**spanning-tree
loopback-detection
trap**

This command enables SNMP trap notification for Spanning Tree loopback BPDUs. Use the **no** form to restore the default.

SYNTAX

[no] spanning-tree loopback-detection trap

DEFAULT SETTING

Disabled

COMMAND MODE

Interface Configuration (Ethernet, Port Channel)

EXAMPLE

```
Console(config)#interface ethernet 1/5
Console(config-if)#spanning-tree loopback-detection trap
```

**spanning-tree
mst cost**

This command configures the path cost on a spanning instance in the Multiple Spanning Tree. Use the **no** form to restore the default auto-configuration mode.

SYNTAX

spanning-tree mst *instance-id* cost *cost*

no spanning-tree mst *instance-id* cost

instance-id - Instance identifier of the spanning tree.
(Range: 0-4094)

cost - Path cost for an interface. (Range: 0 for auto-configuration, 1-65535 for short path cost method²⁸, 1-200,000,000 for long path cost method)

The recommended path cost range is listed in [Table 137 on page 1105](#).

DEFAULT SETTING

By default, the system automatically detects the speed and duplex mode used on each port, and configures the path cost according to the values shown below. Path cost "0" is used to indicate auto-configuration mode. When the short path cost method is selected and the default path cost recommended by the IEEE 8021w standard exceeds 65,535, the default is set to 65,535. The default path costs are listed in [Table 138 on page 1105](#).

COMMAND MODE

Interface Configuration (Ethernet, Port Channel)

COMMAND USAGE

- ◆ Each spanning-tree instance is associated with a unique set of VLAN IDs.

²⁸. Use the [spanning-tree pathcost method](#) command to set the path cost method.

- ◆ This command is used by the multiple spanning-tree algorithm to determine the best path between devices. Therefore, lower values should be assigned to interfaces attached to faster media, and higher values assigned to interfaces with slower media.
- ◆ Use the **no spanning-tree mst cost** command to specify auto-configuration mode.
- ◆ Path cost takes precedence over interface priority.

EXAMPLE

```
Console(config)#interface Ethernet 1/5
Console(config-if)#spanning-tree mst 1 cost 50
Console(config-if)#
```

RELATED COMMANDS

[spanning-tree mst port-priority \(1111\)](#)

spanning-tree mst port-priority

This command configures the interface priority on a spanning instance in the Multiple Spanning Tree. Use the **no** form to restore the default.

SYNTAX

spanning-tree mst *instance-id* **port-priority** *priority*

no spanning-tree mst *instance-id* **port-priority**

instance-id - Instance identifier of the spanning tree.
(Range: 0-4094)

priority - Priority for an interface. (Range: 0-240 in steps of 16)

DEFAULT SETTING

128

COMMAND MODE

Interface Configuration (Ethernet, Port Channel)

COMMAND USAGE

- ◆ This command defines the priority for the use of an interface in the multiple spanning-tree. If the path cost for all interfaces on a switch are the same, the interface with the highest priority (that is, lowest value) will be configured as an active link in the spanning tree.
- ◆ Where more than one interface is assigned the highest priority, the interface with lowest numeric identifier will be enabled.

EXAMPLE

```
Console(config)#interface Ethernet 1/5
Console(config-if)#spanning-tree mst 1 port-priority 0
Console(config-if)#
```

RELATED COMMANDS[spanning-tree mst cost \(1110\)](#)**spanning-tree
port-bpdu-flooding**

This command floods BPDUs to other ports when spanning tree is disabled globally or disabled on a specific port. Use the **no** form to restore the default setting.

SYNTAX

[no] spanning-tree port-bpdu-flooding

DEFAULT SETTING

Enabled

COMMAND MODE

Interface Configuration (Ethernet, Port Channel)

COMMAND USAGE

- ◆ When enabled, BPDUs are flooded to all other ports on the switch or to all other ports within the receiving port's native VLAN as specified by the [spanning-tree system-bpdu-flooding](#) command.
- ◆ The [spanning-tree system-bpdu-flooding](#) command has no effect if BPDU flooding is disabled on a port by the **spanning-tree port-bpdu-flooding** command.

EXAMPLE

```
Console(config)#interface ethernet 1/5
Console(config-if)#spanning-tree port-bpdu-flooding
Console(config-if)#
```

**spanning-tree
port-priority**

This command configures the priority for the specified interface. Use the **no** form to restore the default.

SYNTAX

spanning-tree port-priority *priority*
no spanning-tree port-priority

priority - The priority for a port. (Range: 0-240, in steps of 16)

DEFAULT SETTING

128

COMMAND MODE

Interface Configuration (Ethernet, Port Channel)

COMMAND USAGE

- ◆ This command defines the priority for the use of a port in the Spanning Tree Algorithm. If the path cost for all ports on a switch are the same, the port with the highest priority (that is, lowest value) will be configured as an active link in the spanning tree.
- ◆ Where more than one port is assigned the highest priority, the port with lowest numeric identifier will be enabled.

EXAMPLE

```
Console(config)#interface ethernet 1/5
Console(config-if)#spanning-tree port-priority 0
```

RELATED COMMANDS

[spanning-tree cost \(1105\)](#)

spanning-tree root-guard This command prevents a designated port²⁹ from taking superior BPDUs into account and allowing a new STP root port to be elected. Use the **no** form to disable this feature.

SYNTAX

[no] spanning-tree root-guard

DEFAULT SETTING

Disabled

COMMAND MODE

Interface Configuration (Ethernet, Port Channel)

COMMAND USAGE

- ◆ A bridge with a lower bridge identifier (or same identifier and lower MAC address) can take over as the root bridge at any time.
- ◆ When Root Guard is enabled, and the switch receives a superior BPDU on this port, it is set to the Discarding state until it stops receiving superior BPDUs for a fixed recovery period. While in the discarding state, no traffic is forwarded across the port.
- ◆ Root Guard can be used to ensure that the root bridge is not formed at a suboptimal location. Root Guard should be enabled on any designated port connected to low-speed bridges which could potentially overload a slower link by taking over as the root port and forming a new spanning tree topology. It could also be used to form a border around part of the network where the root bridge is allowed.
- ◆ When spanning tree is initialized globally on the switch or on an interface, the switch will wait for 20 seconds to ensure that the spanning tree has converged before enabling Root Guard.

29. See Port Role under "[Displaying Interface Settings for STA](#)" on page 254.

EXAMPLE

```

Console(config)#interface ethernet 1/5
Console(config-if)#spanning-tree edge-port
Console(config-if)#spanning-tree root-guard
Console(config-if)#

```

**spanning-tree
spanning-disabled**

This command disables the spanning tree algorithm for the specified interface. Use the **no** form to re-enable the spanning tree algorithm for the specified interface.

SYNTAX

[no] spanning-tree spanning-disabled

DEFAULT SETTING

Enabled

COMMAND MODE

Interface Configuration (Ethernet, Port Channel)

EXAMPLE

This example disables the spanning tree algorithm for port 5.

```

Console(config)#interface ethernet 1/5
Console(config-if)#spanning-tree spanning-disabled
Console(config-if)#

```

**spanning-tree
tc-prop-stop**

This command stops the propagation of topology change notifications (TCN). Use the **no** form to allow propagation of TCN messages.

SYNTAX

[no] spanning-tree tc-prop-stop

DEFAULT SETTING

Disabled

COMMAND MODE

Interface Configuration (Ethernet, Port Channel)

COMMAND USAGE

- ◆ When this command is enabled on an interface, topology change information originating from the interface will still be propagated.
- ◆ This command should not be used on an interface which is purposely configured in a ring topology.

EXAMPLE

```

Console(config)#interface ethernet 1/1
Console(config-if)#spanning-tree tc-prop-stop
Console(config-if)#

```

spanning-tree loopback-detection release

This command manually releases a port placed in discarding state by loopback-detection.

SYNTAX

spanning-tree loopback-detection release *interface*

interface

ethernet *unit/port*

unit - Unit identifier. (Range: 1)

port - Port number. (Range: 1-28/52)

port-channel *channel-id* (Range: 1-16)

COMMAND MODE

Privileged Exec

COMMAND USAGE

Use this command to release an interface from discarding state if loopback detection release mode is set to "manual" by the [spanning-tree loopback-detection release-mode](#) command and BPDU loopback occurs.

EXAMPLE

```

Console#spanning-tree loopback-detection release ethernet 1/1
Console#

```

spanning-tree protocol-migration

This command re-checks the appropriate BPDU format to send on the selected interface.

SYNTAX

spanning-tree protocol-migration *interface*

interface

ethernet *unit/port*

unit - Unit identifier. (Range: 1)

port - Port number. (Range: 1-28/52)

port-channel *channel-id* (Range: 1-16)

COMMAND MODE

Privileged Exec

COMMAND USAGE

If at any time the switch detects STP BPDUs, including Configuration or Topology Change Notification BPDUs, it will automatically set the selected interface to forced STP-compatible mode. However, you can also use the **spanning-tree protocol-migration** command at any time to manually re-check the appropriate BPDU format to send on the selected interfaces (i.e., RSTP or STP-compatible).

EXAMPLE

```
Console#spanning-tree protocol-migration eth 1/5
Console#
```

show spanning-tree This command shows the configuration for the common spanning tree (CST), for all instances within the multiple spanning tree (MST), or for a specific instance within the multiple spanning tree (MST).

SYNTAX

show spanning-tree [*interface* | **mst** *instance-id* | **brief** | **stp-enabled-only**]

interface

ethernet *unit/port*

unit - Unit identifier. (Range: 1)

port - Port number. (Range: 1-28/52)

port-channel *channel-id* (Range: 1-16)

instance-id - Instance identifier of the multiple spanning tree. (Range: 0-4094)

brief - Shows a summary of global and interface settings.

stp-enabled-only - Displays global settings, and settings for interfaces for which STP is enabled.

DEFAULT SETTING

None

COMMAND MODE

Privileged Exec

COMMAND USAGE

- ◆ Use the **show spanning-tree** command with no parameters to display the spanning tree configuration for the switch for the Common Spanning Tree (CST) and for every interface in the tree.
- ◆ Use the **show spanning-tree interface** command to display the spanning tree configuration for an interface within the Common Spanning Tree (CST).

- ◆ Use the **show spanning-tree mst** command to display the spanning tree configuration for all instances within the Multiple Spanning Tree (MST), including global settings and settings for active interfaces.
- ◆ Use the **show spanning-tree mst *instance-id*** command to display the spanning tree configuration for an instance within the Multiple Spanning Tree (MST), including global settings and settings for all interfaces.
- ◆ For a description of the items displayed under "Spanning-tree information," see ["Configuring Global Settings for STA" on page 243](#). For a description of the items displayed for specific interfaces, see ["Displaying Interface Settings for STA" on page 254](#).

EXAMPLE

```

Console#show spanning-tree
Spanning Tree Information
-----
Spanning Tree Mode           : MSTP
Spanning Tree Enabled/Disabled : Enabled
Instance                     : 0
VLANs Configured            : 1-4094
Priority                      : 32768
Bridge Hello Time (sec.)     : 2
Bridge Max. Age (sec.)       : 20
Bridge Forward Delay (sec.)  : 15
Root Hello Time (sec.)       : 2
Root Max. Age (sec.)         : 20
Root Forward Delay (sec.)    : 15
Max. Hops                    : 20
Remaining Hops               : 20
Designated Root              : 32768.0.0001ECF8D8C6
Current Root Port            : 21
Current Root Cost            : 100000
Number of Topology Changes   : 5
Last Topology Change Time (sec.): 11409
Transmission Limit          : 3
Path Cost Method             : Long
Flooding Behavior            : To VLAN
Cisco Prestandard            : Disabled
-----

Eth 1/ 1 information
-----
Admin Status                 : Enabled
Role                         : Disabled
State                        : Discarding
External Admin Path Cost     : 0
Internal Admin Path Cost     : 0
External Oper Path Cost      : 100000
Internal Oper Path Cost      : 100000
Priority                      : 128
Designated Cost              : 100000
Designated Port              : 128.1
Designated Root              : 32768.0.0001ECF8D8C6
Designated Bridge            : 32768.0.123412341234
Forward Transitions          : 4
Admin Edge Port              : Disabled
Oper Edge Port               : Disabled
Admin Link Type              : Auto
Oper Link Type               : Point-to-point
Flooding Behavior            : Enabled

```

```

Spanning-Tree Status           : Enabled
Loopback Detection Status      : Enabled
Loopback Detection Release Mode : Auto
Loopback Detection Trap        : Disabled
Loopback Detection Action      : Shutdown, 300 seconds
Root Guard Status              : Disabled
BPDU Guard Status              : Disabled
BPDU Guard Auto Recovery       : Disabled
BPDU Guard Auto Recovery Interval : 300
BPDU Filter Status             : Disabled
TC Propagate Stop              : Disabled
:
:
:

```

This example shows a brief summary of global and interface setting for the spanning tree.

```

Console#show spanning-tree brief
Spanning Tree Mode           : RSTP
Spanning Tree Enabled/Disabled : Enabled
Designated Root              : 32768.0000E89382A0
Current Root Port             : 0
Current Root Cost             : 0

Interface Pri Designated      Designated Oper   STP   Role State Oper
           Bridge ID          Port ID   Cost   Status
-----
Eth 1/ 1  128 32768.0000E89382A0    128.1     100000 EN    DESG FWD  No
Eth 1/ 2  128 32768.0000E89382A0    128.2     10000  EN    DISB BLK No
Eth 1/ 3  128 32768.0000E89382A0    128.3     10000  EN    DISB BLK No
Eth 1/ 4  128 32768.0000E89382A0    128.4     10000  EN    DISB BLK No
Eth 1/ 5  128 32768.0000E89382A0    128.5     10000  EN    DISB BLK No
:
:
:

```

show spanning-tree mst configuration

This command shows the configuration of the multiple spanning tree.

COMMAND MODE
Privileged Exec

EXAMPLE

```

Console#show spanning-tree mst configuration
Mstp Configuration Information
-----
Configuration Name : R&D
Revision Level      :0

Instance VLANs
-----
0      1-4094
Console#

```

The G.8032 recommendation, also referred to as Ethernet Ring Protection Switching (ERPS), can be used to increase the availability and robustness of Ethernet rings.

This chapter describes commands used to configure ERPS.

Table 139: ERPS Commands

Command	Function	Mode
<code>erps</code>	Enables ERPS globally on the switch	GC
<code>erps domain</code>	Creates an ERPS ring and enters ERPS configuration mode	GC
<code>control-vlan</code>	Adds a Control VLAN to an ERPS ring	ERPS
<code>enable</code>	Activates the current ERPS ring	ERPS
<code>guard-timer</code>	Sets the timer to prevent ring nodes from receiving outdated R-APS messages	ERPS
<code>holdoff-timer</code>	Sets the timer to filter out intermittent link faults	ERPS
<code>major-domain</code>	Specifies the ERPS ring used for sending control packets	ERPS
<code>meg-level</code>	Sets the Maintenance Entity Group level for a ring	ERPS
<code>mep-monitor</code>	Specifies the CCM MEPs used to monitor the link on a ring node	ERPS
<code>node-id</code>	Sets the MAC address for a ring node	ERPS
<code>non-erps-dev-protect</code>	Sends non-standard health-check packets when in protection state	ERPS
<code>non-revertive</code>	Enables non-revertive mode, which requires the protection state on the RPL to manually cleared	ERPS
<code>propagate-tc</code>	Enables propagation of topology change messages from a secondary ring to the primary ring	ERPS
<code>raps-def-mac</code>	Sets the switch's MAC address to be used as the node identifier in R-APS messages	ERPS
<code>raps-without-vc</code>	Terminates the R-APS channel at the primary ring to sub-ring interconnection nodes	ERPS
<code>ring-port</code>	Configures a node's connection to the ring through the east or west interface	ERPS
<code>rpl neighbor</code>	Configures a ring node to be the RPL neighbor	ERPS
<code>rpl owner</code>	Configures a ring node to be the RPL owner	ERPS
<code>version</code>	Specifies compatibility with ERPS version 1 or 2	ERPS
<code>wtr-timer</code>	Sets timer to verify that the ring has stabilized before blocking the RPL after recovery from a signal failure	ERPS
<code>clear erps statistics</code>	Clears statistics, including SF, NR, NR-RB, FS, MS, Event, and Health protocol messages	PE

Table 139: ERPS Commands(Continued)

Command	Function	Mode
<code>erps clear</code>	Manually clears protection state which has been invoked by a Forced Switch or Manual Switch command, and the node is operating under non-revertive mode; or before the WTR or WTB timer expires when the node is operating in revertive mode	PE
<code>erps forced-switch</code>	Blocks the specified ring port	PE
<code>erps manual-switch</code>	Blocks the specified ring port, in the absence of a failure or an <code>erps forced-switch</code> command	PE
<code>show erps</code>	Displays status information for all configured rings, or for a specified ring	PE

Configuration Guidelines for ERPS

1. Create an ERPS ring: Create a ring using the `erps domain` command. The ring name is used as an index in the G.8032 database.
2. Configure the east and west interfaces: Each node on the ring connects to it through two ring ports. Use the `ring-port` command to configure one port connected to the next node in the ring to the east (or clockwise direction); and then use the `ring-port` command again to configure another port facing west in the ring.
3. Configure the RPL owner: Configure one node in the ring as the Ring Protection Link (RPL) owner using the `rpl owner` command. When this switch is configured as the RPL owner, the west ring port is set as being connected to the RPL. Under normal operations (Idle state), the RPL is blocked to ensure that a loop cannot form in the ring. If a signal failure brings down any other link in the ring, the RPL will be unblocked (Protection state) to ensure proper connectivity among all ring nodes until the failure is recovered.
4. Configure ERPS timers: Use the `guard-timer` command to set the timer is used to prevent ring nodes from receiving outdated R-APS messages, the `holdoff-timer` command to filter out intermittent link faults, and the `wtr-timer` command to verify that the ring has stabilized before blocking the RPL after recovery from a signal failure.
5. Configure the ERPS Control VLAN (CVLAN): Use the `control-vlan` command to create the VLAN used to pass R-APS ring maintenance commands. The CVLAN must NOT be configured with an IP address. In addition, only ring ports may be added to the CVLAN (prior to configuring the VLAN as a CVLAN). No other ports can be members of this VLAN (once set as a CVLAN). Also, the ring ports of the CVLAN must be tagged. Failure to observe these restrictions can result in a loop in the network.
6. Enable ERPS: Before enabling a ring as described in the next step, first use the `erps` command to globally enable ERPS on the switch. If ERPS has not yet been enabled or has been disabled with the `no erps` command, no ERPS rings will work.

7. Enable an ERPS ring: Before an ERPS ring can work, it must be enabled using the `enable` command. When configuration is completed and the ring enabled, R-APS messages will start flowing in the control VLAN, and normal traffic will begin to flow in the data VLANs. To stop a ring, it can be disabled on any node using the `no enable` command.
8. Display ERPS status information: Use the `show erps` command to display general ERPS status information or detailed ERPS status information for a specific ring.

erps This command enables ERPS on the switch. Use the **no** form to disable this feature.

SYNTAX

[no] erps

DEFAULT SETTING

Disabled

COMMAND MODE

Global Configuration

COMMAND USAGE

ERPS must be enabled globally on the switch before it can be enabled on an ERPS ring using the `enable` command.

EXAMPLE

```
Console(config)#erps
Console(config)#
```

RELATED COMMANDS

[enable \(1123\)](#)

erps domain This command creates an ERPS ring and enters ERPS configuration mode for the specified domain. Use the **no** form to delete a ring.

SYNTAX

erps domain *ring-name* [**id** *ring-id*]

no erps domain

ring-name - Name of a specific ERPS ring. (Range: 1-12 characters)

ring-id - ERPS ring identifier used in R-APS messages.
(Range: 1-255)

DEFAULT SETTING

None

COMMAND MODE

Global Configuration

COMMAND USAGE

- ◆ Service Instances within each ring are based on a unique maintenance association for the specific users, distinguished by the ring name, maintenance level, maintenance association's name, and assigned VLAN. Up to 26 ERPS rings can be configured on the switch.
- ◆ R-APS information is carried in an R-APS PDUs. The last octet of the MAC address is designated as the Ring ID (01-19-A7-00-00-[Ring ID]). If use of the default MAC address is disabled with the `no raps-def-mac` command, then the Ring ID configured by the `erps domain` command will be used in R-APS PDUs.

EXAMPLE

```
Console(config)#erps domain r&d id 1
Console(config-erps)#
```

control-vlan This command specifies a dedicated VLAN used for sending and receiving ERPS protocol messages. Use the **no** form to remove the Control VLAN.

SYNTAX

[no] control-vlan *vlan-id*

vlan-id - VLAN ID (Range: 1-4094)

DEFAULT SETTING

None

COMMAND MODE

ERPS Configuration

COMMAND USAGE

- ◆ Configure one control VLAN for each ERPS ring. First create the VLAN to be used as the control VLAN ([vlan](#), [page 1156](#)), add the ring ports for the east and west interface as tagged members to this VLAN ([switchport allowed vlan](#), [page 1159](#)), and then use the `control-vlan` command to add it to the ring.
- ◆ The following restrictions are recommended to avoid creating a loop in the network or other problems which may occur under some situations:
 - The Control VLAN must not be configured as a Layer 3 interface (with an IP address), a dynamic VLAN (with GVRP enabled), nor as a private VLAN.
 - In addition, only ring ports may be added to the Control VLAN. No other ports can be members of this VLAN.
 - Also, the ring ports of the Control VLAN must be tagged.

- ◆ Once the ring has been activated with the `enable` command, the configuration of the control VLAN cannot be modified. Use the `no enable` command to stop the ERPS ring before making any configuration changes to the control VLAN.

EXAMPLE

```

Console(config)#vlan database
Console(config-vlan)#vlan 2 name rdc media ethernet state active
Console(config-vlan)#exit
Console(config)#interface ethernet 1/12
Console(config-if)#switchport allowed vlan add 2 tagged
Console(config-if)#interface ethernet 1/11
Console(config-if)#switchport allowed vlan add 2 tagged
Console(config-if)#exit
Console(config)#erps domain rd1
Console(config-erps)#control-vlan 2
Console(config-erps)#

```

- enable** This command activates the current ERPS ring. Use the **no** form to disable the current ring.

SYNTAX

[no] enable

DEFAULT SETTING

Disabled

COMMAND MODE

ERPS Configuration

COMMAND USAGE

- ◆ Before enabling a ring, the east and west ring ports should be configured on each node with the `ring-port` command, the RPL owner specified with the `rpl owner` command, and the control VLAN configured with the `control-vlan` command.
- ◆ Once enabled, the RPL owner node and non-owner node state machines will start, and the ring will enter idle state if no signal failures are detected.

EXAMPLE

```

Console(config-erps)#enable
Console(config-erps)#

```

RELATED COMMANDS

[erps \(1121\)](#)

guard-timer This command sets the guard timer to prevent ring nodes from receiving outdated R-APS messages. Use the **no** form to restore the default setting.

SYNTAX

guard-timer *milliseconds*

milliseconds - The guard timer is used to prevent ring nodes from receiving outdated R-APS messages. During the duration of the guard timer, all received R-APS messages are ignored by the ring protection control process, giving time for old messages still circulating on the ring to expire. (Range: 10-2000 milliseconds, in steps of 10 milliseconds)

DEFAULT SETTING

500 milliseconds

COMMAND MODE

ERPS Configuration

COMMAND USAGE

The guard timer duration should be greater than the maximum expected forwarding delay for an R-APS message to pass around the ring. A side-effect of the guard timer is that during its duration, a node will be unaware of new or existing ring requests transmitted from other nodes.

EXAMPLE

```
Console(config-erps)#guard-timer 300
Console(config-erps)#
```

holdoff-timer This command sets the timer to filter out intermittent link faults. Use the **no** form to restore the default setting.

SYNTAX

holdoff-timer *milliseconds*

milliseconds - The hold-off timer is used to filter out intermittent link faults. Faults will only be reported to the ring protection mechanism if this timer expires. (Range: 0-10000 milliseconds, in steps of 100 milliseconds)

DEFAULT SETTING

0 milliseconds

COMMAND MODE

ERPS Configuration

COMMAND USAGE

In order to coordinate timing of protection switches at multiple layers, a hold-off timer may be required. Its purpose is to allow, for example, a

server layer protection switch to have a chance to fix the problem before switching at a client layer.

When a new defect or more severe defect occurs (new Signal Failure), this event will not be reported immediately to the protection switching mechanism if the provisioned hold-off timer value is non-zero. Instead, the hold-off timer will be started. When the timer expires, whether a defect still exists or not, the timer will be checked. If one does exist, that defect will be reported to the protection switching mechanism. The reported defect need not be the same one that started the timer.

EXAMPLE

```
Console(config-erps)#holdoff-timer 300
Console(config-erps)#
```

major-domain This command specifies the ERPS ring used for sending control packets. Use the **no** form to remove the current setting.

SYNTAX

major-domain *name*

no major-domain

name - Name of the ERPS ring used for sending control packets.
(Range: 1-32 characters)

DEFAULT SETTING

None

COMMAND MODE

ERPS Configuration

COMMAND USAGE

- ◆ This switch can support up to six rings. However, ERPS control packets can only be sent on one ring. This command is used to indicate that the current ring is a secondary ring, and to specify the major ring which will be used to send ERPS control packets.
- ◆ The Ring Protection Link (RPL) is the west port and can not be configured. So the physical port on a secondary ring must be the west port. In other words, if a domain has two physical ring ports, this ring can only be a major ring, not a secondary ring (or sub-domain) which can have only one physical ring port. This command will therefore fail if the east port is already configured (see the [ring-port](#) command).

EXAMPLE

```
Console(config-erps)#major-domain rd0
Console(config-erps)#
```

meg-level This command sets the Maintenance Entity Group level for a ring. Use the **no** form to restore the default setting.

SYNTAX

meg-level *level*

level - The maintenance entity group (MEG) level which provides a communication channel for ring automatic protection switching (R-APS) information. (Range: 0-7)

DEFAULT SETTING

1

COMMAND MODE

ERPS Configuration

COMMAND USAGE

- ◆ This parameter is used to ensure that received R-APS PDUs are directed for this ring. A unique level should be configured for each local ring if there are many R-APS PDUs passing through this switch.
- ◆ If CFM continuity check messages are used to monitor the link status of an ERPS ring node as specified by the [mep-monitor](#) command, then the MEG level set by the **meg-level** command must match the authorized maintenance level of the CFM domain to which the specified MEP belongs. The MEP's primary VLAN must also be the same as that used for the ERPS ring's control VLAN.

EXAMPLE

```
Console(config-erps)#meg-level 0
Console(config-erps)#
```

RELATED COMMANDS

[ethernet cfm domain \(1353\)](#)
[ethernet cfm mep \(1358\)](#)

mep-monitor This command specifies the CFM MEPs used to monitor the link on a ring node. Use the **no** form to restore the default setting.

SYNTAX

mep-monitor {**east** | **west**} **mep** *mpid*

east - Connects to next ring node to the east.

west - Connects to next ring node to the west.

mpid - Maintenance end point identifier. (Range: 1-8191)

DEFAULT SETTING

None

COMMAND MODE

ERPS Configuration

COMMAND USAGE

- ◆ If this command is used to monitor the link status of an ERPS node with CFM continuity check messages, then the MEG level set by the [meg-level](#) command must match the authorized maintenance level of the CFM domain to which the specified MEP belongs.
- ◆ To ensure complete monitoring of a ring node, use the **mep-monitor** command to specify the CFM MEPs used to monitor both the east and west ports of the ring node.
- ◆ If CFM determines that a MEP node which has been configured to monitor a ring port with this command has gone down, this information is passed to ERPS, which in turn processes it as a ring node failure. For more information on how ERPS recovers from a node failure, refer to ["Ethernet Ring Protection Switching" on page 495](#).

EXAMPLE

```
Console(config-erps)#mep-monitor east mep 1
Console(config-erps)#
```

RELATED COMMANDS[ethernet cfm domain \(1353\)](#)[ethernet cfm mep \(1358\)](#)

node-id This command sets the MAC address for a ring node. Use the **no** form to restore the default setting.

SYNTAX

node-id *mac-address*

mac-address – A MAC address unique to the ring node. The MAC address must be specified in the format xx-xx-xx-xx-xx-xx or xxxxxxxxxxxx.

DEFAULT SETTING

CPU MAC address

COMMAND MODE

ERPS Configuration

COMMAND USAGE

- ◆ The ring node identifier is used to identify a node in R-APS messages for both automatic and manual switching recovery operations.
For example, a node that has one ring port in SF condition and detects that the condition has been cleared, will continuously transmit R-APS (NR) messages with its own Node ID as priority information over both

ring ports, informing its neighbors that no request is present at this node. When another recovered node holding the link blocked receives this message, it compares the Node ID information with its own. If the received R-APS (NR) message has a higher priority, this unblocks its ring ports. Otherwise, the block remains unchanged.

- ◆ The node identifier may also be used for debugging, such as to distinguish messages when a node is connected to more than one ring.

EXAMPLE

```
Console(config-erps)#node-id 00-12-CF-61-24-2D
Console(config-erps)#
```

non-erps-dev-protect This command sends non-standard health-check packets when an owner node enters protection state without any link down event having been detected through SF messages. Use the **no** form to disable this feature.

SYNTAX

[no] **non-erps-dev-protect**

DEFAULT SETTING

Disabled

COMMAND MODE

ERPS Configuration

COMMAND USAGE

- ◆ The RPL owner node detects a failed link when it receives R-APS (SF - signal fault) messages from nodes adjacent to the failed link. The owner then enters protection state by unblocking the RPL. However, using this standard recovery procedure may cause a non-ERPS device to become isolated when the ERPS device adjacent to it detects a continuity check message (CCM) loss event and blocks the link between the non-ERPS device and ERPS device.

CCMs are propagated by the Connectivity Fault Management (CFM) protocol as described under "[CFM Commands](#)" on page 1347. If the standard recovery procedure were used as shown in the following figure, and node E detected CCM loss, it would send an R-APS (SF) message to the RPL owner and block the link to node D, isolating that non-ERPS device.

Figure 423: Non-ERPS Device Protection

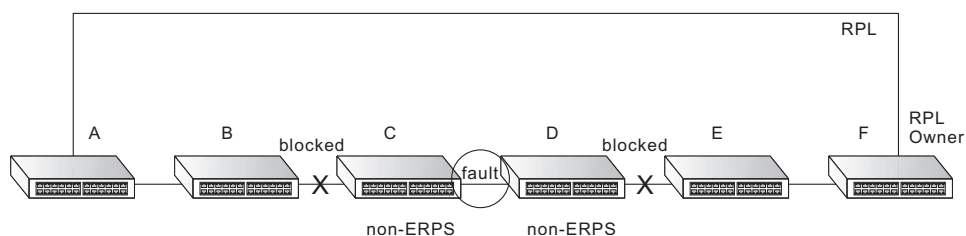

When non-ERPS device protection is enabled on the ring, the ring ports on the RPL owner node and non-owner nodes will not be blocked when signal loss is detected by CCM loss events.

- ◆ When non-ERPS device protection is enabled on an RPL owner node, it will send non-standard health-check packets to poll the ring health when it enters the protection state. It does not use the normal procedure of waiting to receive an R-APS (NR - no request) message from nodes adjacent to the recovered link. Instead, it waits to see if the non-standard health-check packets loop back. If they do, indicating that the fault has been resolved, the RPL will be blocked.

After blocking the RPL, the owner node will still transmit an R-APS (NR, RB - ring blocked) message. ERPS-compliant nodes receiving this message flush their forwarding database and unblock previously blocked ports. The ring is now returned to Idle state.

EXAMPLE

```
Console(config-erps)#non-erps-dev-protect
Console(config-erps)#
```

non-revertive This command enables non-revertive mode, which requires the protection state on the RPL to manually cleared. Use the **no** form to restore the default revertive mode.

SYNTAX

[no] **non-revertive**

DEFAULT SETTING

Disabled

COMMAND MODE

ERPS Configuration

COMMAND USAGE

- ◆ Revertive behavior allows the switch to automatically return the RPL from Protection state to Idle state through the exchange of protocol messages.
Non-revertive behavior for Protection, Forced Switch, and Manual Switch states are basically the same. Non-revertive behavior requires the **erps clear** command to used to return the RPL from Protection state to Idle state.
- ◆ Recovery for Protection Switching – A ring node that has one or more ring ports in an SF (Signal Fail) condition, upon detecting the SF condition cleared, keeps at least one of its ring ports blocked for the traffic channel and for the R-APS channel, until the RPL is blocked as a result of ring protection reversion, or until there is another higher priority request (e.g., an SF condition) in the ring.

A ring node that has one ring port in an SF condition and detects the SF condition cleared, continuously transmits the R-APS (NR – no request) message with its own Node ID as the priority information over both ring ports, informing that no request is present at this ring node and initiates a guard timer. When another recovered ring node (or nodes) holding the link block receives this message, it compares the Node ID information with its own Node ID. If the received R-APS (NR) message has the higher priority, this ring node unblocks its ring ports. Otherwise, the block remains unchanged. As a result, there is only one link with one end blocked.

The ring nodes stop transmitting R-APS (NR) messages when they accept an R-APS (NR, RB – RPL Blocked), or when another higher priority request is received.

- Recovery with Revertive Mode – When all ring links and ring nodes have recovered and no external requests are active, reversion is handled in the following way:
 - a. The reception of an R-APS (NR) message causes the RPL Owner Node to start the WTR (Wait-to-Restore) timer.
 - b. The WTR timer is cancelled if during the WTR period a higher priority request than NR is accepted by the RPL Owner Node or is declared locally at the RPL Owner Node.
 - c. When the WTR timer expires, without the presence of any other higher priority request, the RPL Owner Node initiates reversion by blocking its traffic channel over the RPL, transmitting an R-APS (NR, RB) message over both ring ports, informing the ring that the RPL is blocked, and performing a flush FDB action.
 - d. The acceptance of the R-APS (NR, RB) message causes all ring nodes to unblock any blocked non-RPL link that does not have an SF condition. If it is an R-APS (NR, RB) message without a DNF (do not flush) indication, all ring nodes flush the FDB.
- Recovery with Non-revertive Mode – In non-revertive operation, the ring does not automatically revert when all ring links and ring nodes have recovered and no external requests are active. Non-revertive operation is handled in the following way:
 - a. The RPL Owner Node does not generate a response on reception of an R-APS (NR) messages.
 - b. When other healthy ring nodes receive the NR (Node ID) message, no action is taken in response to the message.
 - c. When the operator issues the [erps clear](#) command for non-revertive mode at the RPL Owner Node, the non-revertive operation is cleared, the RPL Owner Node blocks its RPL port, and transmits an R-APS (NR, RB) message in both directions, repeatedly.
 - d. Upon receiving an R-APS (NR, RB) message, any blocking node should unblock its non-failed ring port. If it is an R-APS (NR, RB) message without a DNF indication, all ring nodes flush the FDB.

- ◆ Recovery for Forced Switching – An `erps forced-switch` command is removed by issuing the `erps clear` command to the same ring node where Forced Switch mode is in effect. The clear command removes any existing local operator commands, and triggers reversion if the ring is in revertive behavior mode.

The ring node where the Forced Switch was cleared keeps the ring port blocked for the traffic channel and for the R-APS channel, due to the previous Forced Switch command. This ring port is kept blocked until the RPL is blocked as a result of ring protection reversion, or until there is another higher priority request (e.g., an SF condition) in the ring.

The ring node where the Forced Switch was cleared continuously transmits the R-APS (NR) message on both ring ports, informing other nodes that no request is present at this ring node. The ring nodes stop transmitting R-APS (NR) messages when they accept an RAPS (NR, RB) message, or when another higher priority request is received.

If the ring node where the Forced Switch was cleared receives an R-APS (NR) message with a Node ID higher than its own Node ID, it unblocks any ring port which does not have an SF condition and stops transmitting R-APS (NR) message over both ring ports.

- Recovery with revertive mode is handled in the following way:
 - a. The reception of an R-APS (NR) message causes the RPL Owner Node to start the WTB timer.
 - b. The WTB timer is cancelled if during the WTB period a higher priority request than NR is accepted by the RPL Owner Node or is declared locally at the RPL Owner Node.
 - c. When the WTB timer expires, in the absence of any other higher priority request, the RPL Owner Node initiates reversion by blocking the traffic channel over the RPL, transmitting an R-APS (NR, RB) message over both ring ports, informing the ring that the RPL is blocked, and flushes the FDB.
 - d. The acceptance of the R-APS (NR, RB) message causes all ring nodes to unblock any blocked non-RPL that does not have an SF condition. If it is an R-APS (NR, RB) message without a DNF indication, all ring nodes flush their FDB. This action unblocks the ring port which was blocked as a result of an operator command.
- Recovery with non-revertive mode is handled in the following way:
 - a. The RPL Owner Node, upon reception of an R-APS(NR) message and in the absence of any other higher priority request does not perform any action.
 - b. Then, after the operator issues the `erps clear` command at the RPL Owner Node, this ring node blocks the ring port attached to the RPL, transmits an R-APS (NR, RB) message on both ring ports, informing the ring that the RPL is blocked, and flushes its FDB.
 - c. The acceptance of the R-APS (NR, RB) message triggers all ring nodes to unblock any blocked non-RPL which does not have an

SF condition. If it is an R-APS (NR, RB) message without a DNF indication, all ring nodes flush their FDB. This action unblocks the ring port which was blocked as result of an operator command.

- ◆ Recovery for Manual Switching – An `erps manual-switch` command is removed by issuing the `erps clear` command at the same ring node where the Manual Switch is in effect. The clear command removes any existing local operator commands, and triggers reversion if the ring is in revertive behavior mode.

The ring node where the Manual Switch was cleared keeps the ring port blocked for the traffic channel and for the R-APS channel, due to the previous Manual Switch command. This ring port is kept blocked until the RPL is blocked as a result of ring protection reversion, or until there is another higher priority request (e.g., an SF condition) in the ring.

The Ethernet Ring Node where the Manual Switch was cleared continuously transmits the R-APS (NR) message on both ring ports, informing that no request is present at this ring node. The ring nodes stop transmitting R-APS (NR) messages when they accept an RAPS (NR, RB) message, or when another higher priority request is received.

If the ring node where the Manual Switch was cleared receives an R-APS (NR) message with a Node ID higher than its own Node ID, it unblocks any ring port which does not have an SF condition and stops transmitting R-APS (NR) message on both ring ports.

- Recovery with revertive mode is handled in the following way:
 - a. The RPL Owner Node, upon reception of an R-APS (NR) message and in the absence of any other higher priority request, starts the WTB timer and waits for it to expire. While the WTB timer is running, any latent R-APS (MS) message is ignored due to the higher priority of the WTB running signal.
 - b. When the WTB timer expires, it generates the WTB expire signal. The RPL Owner Node, upon reception of this signal, initiates reversion by blocking the traffic channel on the RPL, transmitting an R-APS (NR, RB) message over both ring ports, informing the ring that the RPL is blocked, and flushes its FDB.
 - c. The acceptance of the R-APS (NR, RB) message causes all ring nodes to unblock any blocked non-RPL that does not have an SF condition. If it is an R-APS (NR, RB) message without a DNF indication, all Ethernet Ring Nodes flush their FDB. This action unblocks the ring port which was blocked as a result of an operator command.
- Recovery with non-revertive mode is handled in the following way:
 - a. The RPL Owner Node, upon reception of an R-APS (NR) message and in the absence of any other higher priority request does not perform any action.
 - b. Then, after the operator issues the `erps clear` command at the RPL Owner Node, this ring node blocks the ring port attached to the RPL, transmits an R-APS (NR, RB) message over both ring

ports, informing the ring that the RPL is blocked, and flushes its FDB.

- c. The acceptance of the R-APS (NR, RB) message triggers all ring nodes to unblock any blocked non-RPL which does not have an SF condition. If it is an R-APS (NR, RB) message without a DNF indication, all ring nodes flush their FDB. This action unblocks the ring port which was blocked as result of an operator command.

EXAMPLE

```
Console(config-erps) #non-revertive
Console(config-erps) #
```

propagate-tc This command enables propagation of topology change messages for a secondary ring to the primary ring. Use the **no** form to disable this feature.

SYNTAX

[no] **propagate-tc**

DEFAULT SETTING

Disabled

COMMAND MODE

ERPS Configuration

COMMAND USAGE

- ◆ When a secondary ring detects a topology change, it can pass a message about this event to the major ring. When the major ring receives this kind of message from a secondary ring, it can clear the MAC addresses on its ring ports to help the secondary ring restore its connections more quickly through protection switching.
- ◆ When the MAC addresses are cleared, data traffic may flood onto the major ring. The data traffic will become stable after the MAC addresses are learned again. The major ring will not be broken, but the bandwidth of data traffic on the major ring may suffer for a short period of time due to this flooding behavior.

EXAMPLE

```
Console(config-erps) #propagate-tc
Console(config-erps) #
```

raps-def-mac This command sets the switch's MAC address to be used as the node identifier in R-APS messages. Use the **no** form to use the node identifier specified in the G8032 standards.

SYNTAX

[no] raps-def-mac

DEFAULT SETTING

Enabled

COMMAND MODE

ERPS Configuration

COMMAND USAGE

- ◆ When ring nodes running ERPSv1 and ERPSv2 co-exist on the same ring, the Ring ID of each ring node must be configured as "1".
- ◆ If this command is disabled, the following strings are used as the node identifier:
 - ERPSv1: 01-19-A7-00-00-01
 - ERPSv2: 01-19-A7-00-00-[Ring ID]

EXAMPLE

```
Console(config-erps)#raps-def-mac
Console(config-erps)#
```

raps-without-vc This command terminates the R-APS channel at the primary ring to sub-ring interconnection nodes. Use the **no** form to restore the default setting.

SYNTAX

[no] raps-without-vc

DEFAULT SETTING

R-APS with Virtual Channel

COMMAND MODE

ERPS Configuration

COMMAND USAGE

- ◆ A sub-ring may be attached to a primary ring with or without a virtual channel. A virtual channel is used to connect two interconnection points on the sub-ring, tunneling R-APS control messages across an arbitrary Ethernet network topology. If a virtual channel is not used to cross the intermediate Ethernet network, data in the traffic channel will still flow across the network, but the all R-APS messages will be terminated at the interconnection points.

- ◆ Sub-ring with R-APS Virtual Channel – When using a virtual channel to tunnel R-APS messages between interconnection points on a sub-ring, the R-APS virtual channel may or may not follow the same path as the traffic channel over the network. R-APS messages that are forwarded over the sub-ring’s virtual channel are broadcast or multicast over the interconnected network. For this reason the broadcast/multicast domain of the virtual channel should be limited to the necessary links and nodes. For example, the virtual channel could span only the interconnecting rings or sub-rings that are necessary for forwarding R-APS messages of this sub-ring. Care must also be taken to ensure that the local RAPS messages of the sub-ring being transported over the virtual channel into the interconnected network can be uniquely distinguished from those of other interconnected ring R-APS messages. This can be achieved by, for example, by using separate VIDs for the virtual channels of different sub-rings.

Note that the R-APS virtual channel requires a certain amount of bandwidth to forward R-APS messages on the interconnected Ethernet network where a sub-ring is attached. Also note that the protection switching time of the sub-ring may be affected if R-APS messages traverse a long distance over an R-APS virtual channel.

Figure 424: Sub-ring with Virtual Channel

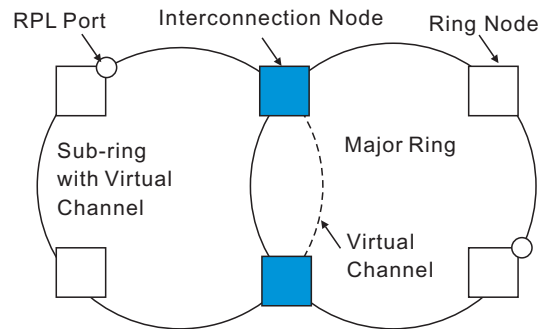

- ◆ Sub-ring without R-APS Virtual Channel – Under certain circumstances it may not be desirable to use a virtual channel to interconnect the sub-ring over an arbitrary Ethernet network. In this situation, the R-APS messages are terminated on the interconnection points. Since the sub-ring does not provide an R-APS channel nor R-APS virtual channel beyond the interconnection points, R-APS channel blocking is not employed on the normal ring links to avoid channel segmentation. As a result, a failure at any ring link in the sub-ring will cause the R-APS channel of the sub-ring to be segmented, thus preventing R-APS message exchange between some of the sub-ring’s ring nodes.

No R-APS messages are inserted or extracted by other rings or sub-rings at the interconnection nodes where a sub-ring is attached. Hence there is no need for either additional bandwidth or for different VIDs/ Ring IDs for the ring interconnection. Furthermore, protection switching time for a sub-ring is independent from the configuration or topology of the interconnected rings. In addition, this option always ensures that an interconnected network forms a tree topology regardless of its interconnection configuration. This means that it is not necessary to take precautions against forming a loop which is potentially composed of a whole interconnected network.

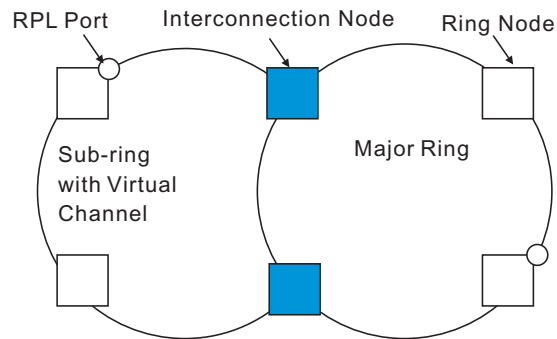
Figure 425: Sub-ring without Virtual Channel**EXAMPLE**

```
Console(config-erps)#raps-without-vc
Console(config-erps)#
```

ring-port This command configures a node's connection to the ring through the east or west interface. Use the **no** form to disassociate a node from the ring.

SYNTAX

ring-port {**east** | **west**} **interface** *interface*

east - Connects to next ring node to the east.

west - Connects to next ring node to the west.

interface

ethernet *unit/port*

unit - Unit identifier. (Range: 1)

port - Port number. (Range: 1-12)

port-channel *channel-id* (Range: 1-12)

DEFAULT SETTING

Not associated

COMMAND MODE

ERPS Configuration

COMMAND USAGE

- ◆ Each node must be connected to two neighbors on the ring. For convenience, the ports connected are referred to as east and west ports. Alternatively, the closest neighbor to the east should be the next node in the ring in a clockwise direction, and the closest neighbor to the west should be the next node in the ring in a counter-clockwise direction.
- ◆ Note that a ring port cannot be configured as a member of a spanning tree, a dynamic trunk, or a static trunk.

- ◆ If a port channel (static trunk) is specified as a ring port, it can not be destroyed before it is removed from the domain configuration.
- ◆ A static trunk will be treated as a signal fault, if it contains no member ports or all of its member ports are in signal fault.
- ◆ If a static trunk is configured as a ring port prior to assigning any member ports, spanning tree will be disabled for the first member port assigned to the static trunk.

EXAMPLE

```
Console(config-erps)#ring-port east interface ethernet 1/12
Console(config-erps)#
```

rpl neighbor This command configures a ring node to be the Ring Protection Link (RPL) neighbor. Use the **no** form to restore the default setting.

SYNTAX

rpl neighbor

no rpl

DEFAULT SETTING

None (that is, neither owner nor neighbor)

COMMAND MODE

ERPS Configuration

COMMAND USAGE

- ◆ The RPL neighbor node, when configured, is a ring node adjacent to the RPL that is responsible for blocking its end of the RPL under normal conditions (i.e., the ring is established and no requests are present in the ring) in addition to the block at the other end by the RPL Owner Node. The RPL neighbor node may participate in blocking or unblocking its end of the RPL, but is not responsible for activating the reversion behavior.
- ◆ Only one RPL owner can be configured on a ring. If the switch is set as the RPL owner for an ERPS domain, the west ring port is set as one end of the RPL. If the switch is set as the RPL neighbor for an ERPS domain, the east ring port is set as the other end of the RPL.
- ◆ The east and west connections to the ring must be specified for all ring nodes using the [ring-port](#) command. When this switch is configured as the RPL neighbor, the east ring port is set as being connected to the RPL.
- ◆ Note that is not mandatory to declare a RPL neighbor.

EXAMPLE

```
Console(config-erps)#rpl neighbor
Console(config-erps)#
```

rpl owner This command configures a ring node to be the Ring Protection Link (RPL) owner. Use the **no** form to restore the default setting.

SYNTAX

rpl owner

no rpl

DEFAULT SETTING

None (that is, neither owner nor neighbor)

COMMAND MODE

ERPS Configuration

COMMAND USAGE

- ◆ Only one RPL owner can be configured on a ring. The owner blocks traffic on the RPL during Idle state, and unblocks it during Protection state (that is, when a signal fault is detected on the ring or the protection state is enabled with the [erps forced-switch](#) or [erps manual-switch](#) command).
- ◆ The east and west connections to the ring must be specified for all ring nodes using the [ring-port](#) command. When this switch is configured as the RPL owner, the west ring port is automatically set as being connected to the RPL.

EXAMPLE

```
Console(config-erps)#rpl owner
Console(config-erps)#
```

version This command specifies compatibility with ERPS version 1 or 2.

SYNTAX

version {1 | 2}

1 - ERPS version 1 based on ITU-T G.8032/Y.1344.

2 - ERPS version 2 based on ITU-T G.8032/Y.1344 Version 2.

DEFAULT SETTING

2

COMMAND MODE

ERPS Configuration

COMMAND USAGE

- ◆ In addition to the basic features provided by version 1, version 2 also supports:
 - Multi-ring/ladder network support
 - Revertive/Non-revertive recovery
 - Forced Switch (FS) and Manual Switch (MS) commands for manually blocking a particular ring port
 - Flush FDB (forwarding database) logic which reduces amount of flush FDB operations in the ring
 - Support of multiple ERP instances on a single ring
- ◆ Version 2 is backward compatible with Version 1. If version 2 is specified, the inputs and commands are forwarded transparently. If set to version 1, MS and FS operator commands are filtered, and the switch set to revertive mode.
- ◆ The version number is automatically set to "1" when a ring node, supporting only the functionalities of G.8032v1, exists on the same ring with other nodes that support G.8032v2.
- ◆ When ring nodes running G.8032v1 and G.8032v2 co-exist on a ring, the ring ID of each node is configured as "1".
- ◆ In version 1, the MAC address 01-19-A7-00-00-01 is used for the node identifier. The `raps-def-mac` command has no effect.

EXAMPLE

```

Console(config-erps)#version 1
Console(config-erps)#

```

wtr-timer This command sets the wait-to-restore timer which is used to verify that the ring has stabilized before blocking the RPL after recovery from a signal failure. Use the **no** form to restore the default setting.

SYNTAX

wtr-timer *minutes*

minutes - The wait-to-restore timer is used to verify that the ring has stabilized before blocking the RPL after recovery from a signal failure. (Range: 5-12 minutes)

DEFAULT SETTING

5 minutes

COMMAND MODE

ERPS Configuration

COMMAND USAGE

If the switch goes into ring protection state due to a signal failure, after the failure condition is cleared, the RPL owner will start the wait-to-restore timer and wait until it expires to verify that the ring has stabilized before blocking the RPL and returning to the Idle (normal operating) state.

EXAMPLE

```
Console(config-erps)#wtr-timer 10
Console(config-erps)#
```

clear erps statistics This command clears statistics, including SF, NR, NR-RB, FS, MS, Event, and Health protocol messages.

SYNTAX

clear erps statistics [**domain** *ring-name*]

ring-name - Name of a specific ERPS ring. (Range: 1-12 characters)

COMMAND MODE

Privileged Exec

EXAMPLE

```
Console#clear erps statistics domain r&d
Console#
```

erps clear This command manually clears the protection state which has been invoked by a forced switch or manual switch command, and the node is operating under non-revertive mode; or before the WTR or WTB timer expires when the node is operating in revertive mode.

SYNTAX

erps clear domain *ring-name*

ring-name - Name of a specific ERPS ring. (Range: 1-12 characters)

COMMAND MODE

Privileged Exec

COMMAND USAGE

- ◆ Two steps are required to make a ring operating in non-revertive mode return to Idle state from forced switch or manual switch state:
 1. Issue an **erps clear** command to remove the forced switch command on the node where a local forced switch command is active.
 2. Issue an **erps clear** command on the RPL owner node to trigger the reversion.
- ◆ The **erps clear** command will also stop the WTR and WTB delay timers and reset their values.
- ◆ More detailed information about using this command for non-revertive mode is included under the Command Usage section for the [non-revertive](#) command.

EXAMPLE

```
Console#erps clear domain r&d
Console#
```

erps forced-switch This command blocks the specified ring port.

SYNTAX

erps forced-switch [**domain** *ring-name*] {**east** | **west**}

ring-name - Name of a specific ERPS ring. (Range: 1-12 characters)

east - East ring port.

west - West ring port.

COMMAND MODE

Privileged Exec

COMMAND USAGE

- ◆ A ring with no pending request has a logical topology with the traffic channel blocked at the RPL and unblocked on all other ring links. In this situation, the **erps forced-switch** command triggers protection switching as follows:
 - a. The ring node where a forced switch command was issued blocks the traffic channel and R-APS channel on the ring port to which the command was issued, and unblocks the other ring port.
 - b. The ring node where the forced switch command was issued transmits R-APS messages indicating FS over both ring ports. R-APS (FS) messages are continuously transmitted by this ring node while the local FS command is the ring node's highest priority command (see [Table 140 on page 1142](#)). The R-APS (FS) message informs

other ring nodes of the FS command and that the traffic channel is blocked on one ring port.

- c. A ring node accepting an R-APS (FS) message, without any local higher priority requests unblocks any blocked ring port. This action subsequently unblocks the traffic channel over the RPL.
 - d. The ring node accepting an R-APS (FS) message, without any local higher priority requests stops transmission of R-APS messages.
 - e. The ring node receiving an R-APS (FS) message flushes its FDB.
- ◆ Protection switching on a forced switch request is completed when the above actions are performed by each ring node. At this point, traffic flows around the ring are resumed. From this point on the following rules apply regarding processing of further forced switch commands:

While an existing forced switch request is present in a ring, any new forced switch request is accepted, except on a ring node having a prior local forced switch request. The ring nodes where further forced switch commands are issued block the traffic channel and R-APS channel on the ring port at which the forced switch was issued. The ring node where the forced switch command was issued transmits an R-APS message over both ring ports indicating FS. R-APS (FS) messages are continuously transmitted by this ring node while the local FS command is the ring node’s highest priority command. As such, two or more forced switches are allowed in the ring, which may inadvertently cause the segmentation of an ring. It is the responsibility of the operator to prevent this effect if it is undesirable.

Ring protection requests, commands and R-APS signals have the priorities as specified in the following table.

Table 140: ERPS Request/State Priority

Request / State and Status	Type	Priority
Clear	local	highest
FS	local	
R-APS (FS)	remote	
local SF*	local	
local clear SF	local	
R-APS (SF)	remote	
R-APS (MS)	remote	
MS	local	
WTR Expires	local	
WTR Running	local	
WTB Expires	local	
WTB Running	local	

Table 140: ERPS Request/State Priority (Continued)

Request / State and Status	Type	Priority
R-APS (NR, RB)	remote	
R-APS (NR)	remote	lowest

* If an Ethernet Ring Node is in the Forced Switch state, local SF is ignored.

- ◆ Recovery for forced switching under revertive and non-revertive mode is described under the Command Usage section for the [non-revertive](#) command.
- ◆ When a ring is under an FS condition, and the node at which an FS command was issued is removed or fails, the ring remains in FS state because the FS command can only be cleared at node where the FS command was issued. This results in an unrecoverable FS condition.

When performing a maintenance procedure (e.g., replacing, upgrading) on a ring node (or a ring link), it is recommended that FS commands be issued at the two adjacent ring nodes instead of directly issuing a FS command at the ring node under maintenance in order to avoid falling into the above mentioned unrecoverable situation.

EXAMPLE

```
Console#erps forced-switch domain r&d west
Console#
```

erps manual-switch This command blocks the specified ring port, in the absence of a failure or an [erps forced-switch](#) command.

SYNTAX

erps manual-switch [**domain** *ring-name*] {**east** | **west**}

ring-name - Name of a specific ERPS ring. (Range: 1-12 characters)

east - East ring port.

west - West ring port.

COMMAND MODE

Privileged Exec

COMMAND USAGE

- ◆ A ring with no request has a logical topology with the traffic channel blocked at the RPL and unblocked on all other ring links. In this situation, the **erps manual-switch** command triggers protection switching as follows:
 - a. If no other higher priority commands exist, the ring node, where a manual switch command was issued, blocks the traffic channel and R-APS channel on the ring port to which the command was issued, and unblocks the other ring port.

- b. If no other higher priority commands exist, the ring node where the manual switch command was issued transmits R-APS messages over both ring ports indicating MS. R-APS (MS) message are continuously transmitted by this ring node while the local MS command is the ring node's highest priority command (see [Table 140 on page 1142](#)). The R-APS (MS) message informs other ring nodes of the MS command and that the traffic channel is blocked on one ring port.
 - c. If no other higher priority commands exist and assuming the ring node was in Idle state before the manual switch command was issued, the ring node flushes its local FDB.
 - d. A ring node accepting an R-APS (MS) message, without any local higher priority requests unblocks any blocked ring port which does not have an SF condition. This action subsequently unblocks the traffic channel over the RPL.
 - e. A ring node accepting an R-APS (MS) message, without any local higher priority requests stops transmitting R-APS messages.
 - f. A ring node receiving an R-APS (MS) message flushes its FDB.
- ◆ Protection switching on a manual switch request is completed when the above actions are performed by each ring node. At this point, traffic flows around the ring are resumed. From this point on, the following rules apply regarding processing of further manual switch commands:
 - a. While an existing manual switch request is present in the ring, any new manual switch request is rejected. The request is rejected at the ring node where the new request is issued and a notification is generated to inform the operator that the new MS request was not accepted.
 - b. A ring node with a local manual switch command which receives an R-APS (MS) message with a different Node ID clears its manual switch request and starts transmitting R-APS (NR) messages. The ring node keeps the ring port blocked due to the previous manual switch command.
 - c. An ring node with a local manual switch command that receives an R-APS message or a local request of higher priority than R-APS (MS) clear its manual switch request. The ring node then processes the new higher priority request.
 - ◆ Recovery for manual switching under revertive and non-revertive mode is described under the Command Usage section for the [non-revertive](#) command.

EXAMPLE

```
Console#erps manual-switch domain r&d west
Console#
```

show erps This command displays status information for all configured rings, or for a specified ring

SYNTAX

show erps [**domain** *ring-name*] [**statistics**]

domain - Keyword to display ERPS ring configuration settings.

ring-name - Name of a specific ERPS ring. (Range: 1-32 characters)

statistics - Keyword to display ERPS ring statistics.

COMMAND MODE

Privileged Exec

EXAMPLE

This example displays a summary of all the ERPS rings configured on the switch.

```

Console#show erps
ERPS Status           : Enabled
Number of ERPS Domains : 1

Domain      ID  Enabled Ver  MEL  Ctrl  VLAN  State      Type      Revertive
-----
r&d        1  Yes      2    1      1  Idle      RPL Owner  Yes

          W/E  Interface Port  State  Local SF  Local  FS  Local  MS  MEP  RPL
          ---  ---
          West Eth 1/ 1  Blocking  No      No      No      No      No      Yes
          East Eth 1/ 3  Forwarding No      No      No      No      No      No

```

Console#

Table 141: **show erps** - summary display description

Field	Description
<i>Node Information</i>	
ERPS Status	Shows whether ERPS is enabled on the switch.
Number of ERPS Domains	Shows the number of ERPS rings configured on the switch.
Domain	Displays the name of each ring followed by a brief list of status information
ID	ERPS ring identifier used in R-APS messages.
Enabled	Shows if the specified ring is enabled.
Ver	Shows the ERPS version.
MEL	The maintenance entity group (MEG) level providing a communication channel for ring automatic protection switching (R-APS) information.
Ctrl VLAN	Shows the Control VLAN ID.

Table 141: **show erps** - summary display description (Continued)

Field	Description
State	Shows the following ERPS states: Init – The ERPS ring has started but has not yet determined the status of the ring. Idle – If all nodes in a ring are in this state, it means that all the links in the ring are up. This state will switch to protection state if a link failure occurs. Protection – If a node in this state, it means that a link failure has occurred. This state will switch to idle state if all the failed links recover.
Type	Shows ERPS node type as None, RPL Owner or RPL Neighbor.
Revertive	Shows if revertive or non-revertive recovery is selected.
<i>Interface Information</i>	
W/E	Shows information on the west and east ring port for this node.
Interface	The port or trunk which is configured as a ring port.
Port State	The operational state: Blocking – The transmission and reception of traffic is blocked and the forwarding of R-APS messages is blocked, but the transmission of locally generated R-APS messages is allowed and the reception of all R-APS messages is allowed. Forwarding – The transmission and reception of traffic is allowed; transmission, reception and forwarding of R-APS messages is allowed. Unknown – The interface is not in a known state (includes the domain being disabled).
Local SF	A signal fault generated on a link to the local node.
Local FS	Shows if a forced switch command was issued on this interface.
Local MS	Shows if a manual switch command was issued on this interface.
MEP	The CFM MEP used to monitor the status on this link.
RPL	Shows if this node is connected to the RPL.

This example displays detailed information for the specified ERPS ring.

```

Console#show erps domain rd1
Domain      ID  Enabled Ver  MEL  Ctrl  VLAN  State      Type      Revertive
-----
r&d        1  Yes    2    1    1    Idle      RPL Owner  Yes

Major Domain Node ID      R-APS With VC
-----
00-E0-0C-00-00-FD Yes

R-APS Def MAC Propagate TC Non-ERPS Device Protect
-----
Yes          No          No

Holdoff  Guard  WTB    WTR    WTB Expire WTR Expire
-----
0 ms    500 ms 5500 ms 5 min

W/E  Interface Port State Local SF Local FS Local MS MEP  RPL
-----
West Eth 1/ 1 Blocking No      No      No      Yes
    
```

```
East Eth 1/ 3 Forwarding No No No No
```

```
Console#
```

Table 141 on page 1145 describes most of the parameters shown by **show erps domain** command. The following table includes the remaining parameters.

Table 142: **show erps domain** - detailed display description

Field	Description
Major Domain	Name of the ERPS major domain.
Node ID	A MAC address unique to this ring node.
R-APS with VC	The R-APS Virtual Channel is the R-APS channel connection used to tunnel R-APS messages between two interconnection nodes of a sub-ring in another Ethernet ring or network.
R-APS Def MAC	Indicates if the switch's MAC address is used to identify the node in R-APS messages.
Propagate TC	Shows if the ring is configured to propagate topology change notification messages.
Non-ERPS Device Protect	Shows if the RPL owner node is configured to send non-standard health-check packets when it enters protection state without any link down event having been detected through SF messages
Holdoff	The hold-off timer interval used to filter out intermittent link faults.
Guard	The guard timer interval used to prevent ring nodes from receiving outdated R-APS messages.
WTB	The wait-to-block timer interval used to delay reversion after a Forced Switch or Manual Switch has been cleared.
WTR	The wait-to-restore timer interval used to verify that the ring has stabilized before blocking the RPL after recovery from a signal failure.
WTB Expire	The time before the wait-to-block timer expires.
WTR Expire	The time before the wait-to-restore timer expires.

This example displays statistics for all configured ERPS rings.

```
Console#show erps statistics
ERPS statistics for domain r&d :
Interface  Local SF  Local Clear SF
-----
(W) Eth 1/ 1 0          0
          SF      NR      NR-RB      FS      MS
-----
Sent      0          62         948        0        0
Received  0          0          0          0        0
Ignored   0          0          0          0        0
          EVENT    HEALTH
-----
Sent      0          0
Received  0          0
Ignored   0          0
```

```

Interface      Local SF      Local Clear SF
-----
(E) Eth 1/ 3 0          0
              SF          NR          NR-RB          FS          MS
-----
Sent           0           62           948           0           0
Received       0           0            0            0           0
Ignored        0           0            0            0           0
              EVENT          HEALTH
-----
Sent           0           0
Received       0           0
Ignored        0           0
    
```

Console#

Table 143: **show erps statistics** - detailed display description

Field	Description
Interface	The direction, and port or trunk which is configured as a ring port.
Local SF	A signal fault generated on a link to the local node.
Local Clear SF	The number of times a clear command was issued to terminate protection state entered through a forced switch or manual switch
SF	The number of signal fault messages
NR	The number of no request messages
NR-RB	The number no request - RPL blocked messages
FS	The number of forced switch messages
MS	The number of manual switch messages
EVENT	Any request/state message, excluding FS, SF, MS, and NR
HEALTH	The number of non-standard health-check messages

A VLAN is a group of ports that can be located anywhere in the network, but communicate as though they belong to the same physical segment. This section describes commands used to create VLAN groups, add port members, specify how VLAN tagging is used, and enable automatic VLAN registration for the selected interface.

Table 144: VLAN Commands

Command Group	Function
GVRP and Bridge Extension Commands	Configures GVRP settings that permit automatic VLAN learning; shows the configuration for bridge extension MIB
Editing VLAN Groups	Sets up VLAN groups, including name, VID and state
Configuring VLAN Interfaces	Configures VLAN interface parameters, including ingress and egress tagging mode, ingress filtering, PVID, and GVRP
Displaying VLAN Information	Displays VLAN groups, status, port members, and MAC addresses
Configuring IEEE 802.1Q Tunneling	Configures 802.1Q Tunneling (QinQ Tunneling)
Configuring L2CP Tunneling*	Configures Layer 2 Control Protocol (L2CP) tunneling, either by discarding, processing, or transparently passing control packets across a QinQ tunnel
Configuring VLAN Translation*	Maps VLAN ID between customer and service provider for networks that do not support IEEE 802.1Q tunneling
Configuring Protocol-based VLANs	Configures protocol-based VLANs based on frame type and protocol
Configuring IP Subnet VLANs	Configures IP Subnet-based VLANs
Configuring MAC Based VLANs	Configures MAC-based VLANs
Configuring Voice VLANs	Configures VoIP traffic detection and enables a Voice VLAN

* These functions are not compatible.

GVRP AND BRIDGE EXTENSION COMMANDS

GARP VLAN Registration Protocol defines a way for switches to exchange VLAN information in order to automatically register VLAN members on interfaces across the network. This section describes how to enable GVRP for individual interfaces and globally for the switch, as well as how to display default configuration settings for the Bridge Extension MIB.

Table 145: GVRP and Bridge Extension Commands

Command	Function	Mode
<code>bridge-ext gvrp</code>	Enables GVRP globally for the switch	GC
<code>garp timer</code>	Sets the GARP timer for the selected function	IC
<code>switchport forbidden vlan</code>	Configures forbidden VLANs for an interface	IC
<code>switchport gvrp</code>	Enables GVRP for an interface	IC
<code>show bridge-ext</code>	Shows the global bridge extension configuration	PE
<code>show garp timer</code>	Shows the GARP timer for the selected function	NE, PE
<code>show gvrp configuration</code>	Displays GVRP configuration for the selected interface	NE, PE

bridge-ext gvrp This command enables GVRP globally for the switch. Use the **no** form to disable it.

SYNTAX

[no] bridge-ext gvrp

DEFAULT SETTING

Disabled

COMMAND MODE

Global Configuration

COMMAND USAGE

GVRP defines a way for switches to exchange VLAN information in order to register VLAN members on ports across the network. This function should be enabled to permit automatic VLAN registration, and to support VLANs which extend beyond the local switch.

EXAMPLE

```
Console(config)#bridge-ext gvrp
Console(config)#
```

garp timer This command sets the values for the join, leave and leaveall timers. Use the **no** form to restore the timers' default values.

SYNTAX

garp timer {**join** | **leave** | **leaveall**} *timer-value*

no garp timer {**join** | **leave** | **leaveall**}

{**join** | **leave** | **leaveall**} - Timer to set.

timer-value - Value of timer.

Ranges:

join: 20-1000 centiseconds

leave: 60-3000 centiseconds

leaveall: 500-18000 centiseconds

DEFAULT SETTING

join: 20 centiseconds

leave: 60 centiseconds

leaveall: 1000 centiseconds

COMMAND MODE

Interface Configuration (Ethernet, Port Channel)

COMMAND USAGE

- ◆ Group Address Registration Protocol is used by GVRP and GMRP to register or deregister client attributes for client services within a bridged LAN. The default values for the GARP timers are independent of the media access method or data rate. These values should not be changed unless you are experiencing difficulties with GMRP or GVRP registration/deregistration.
- ◆ Timer values are applied to GVRP for all the ports on all VLANs.
- ◆ Timer values must meet the following restrictions:
 - leave > (2 x join)
 - leaveall > leave



NOTE: Set GVRP timers on all Layer 2 devices connected in the same network to the same values. Otherwise, GVRP may not operate successfully.

EXAMPLE

```
Console(config)#interface ethernet 1/1
Console(config-if)#garp timer join 100
Console(config-if)#
```

RELATED COMMANDS

[show garp timer \(1153\)](#)

switchport forbidden vlan This command configures forbidden VLANs. Use the **no** form to remove the list of forbidden VLANs.

SYNTAX

switchport forbidden vlan {**add** *vlan-list* | **remove** *vlan-list*}

no switchport forbidden vlan

add *vlan-list* - List of VLAN identifiers to add.

remove *vlan-list* - List of VLAN identifiers to remove.

vlan-list - Separate nonconsecutive VLAN identifiers with a comma and no spaces; use a hyphen to designate a range of IDs. (Range: 1-4094).

DEFAULT SETTING

No VLANs are included in the forbidden list.

COMMAND MODE

Interface Configuration (Ethernet, Port Channel)

COMMAND USAGE

- ◆ This command prevents a VLAN from being automatically added to the specified interface via GVRP.
- ◆ If a VLAN has been added to the set of allowed VLANs for an interface, then you cannot add it to the set of forbidden VLANs for that same interface.
- ◆ GVRP cannot be enabled for ports set to Access mode (see the [switchport mode](#) command).

EXAMPLE

The following example shows how to prevent port 1 from being added to VLAN 3:

```
Console(config)#interface ethernet 1/1
Console(config-if)#switchport forbidden vlan add 3
Console(config-if)#
```

switchport gvrp This command enables GVRP for a port. Use the **no** form to disable it.

SYNTAX

[**no**] **switchport gvrp**

DEFAULT SETTING

Disabled

COMMAND MODE

Interface Configuration (Ethernet, Port Channel)

COMMAND USAGEGVRP cannot be enabled for ports set to Access mode using the [switchport mode](#) command.**EXAMPLE**

```

Console(config)#interface ethernet 1/1
Console(config-if)#switchport gvrp
Console(config-if)#

```

show bridge-ext This command shows the configuration for bridge extension commands.**DEFAULT SETTING**

None

COMMAND MODE

Privileged Exec

COMMAND USAGESee "[Displaying Bridge Extension Capabilities](#)" on page 127 for a description of the displayed items.**EXAMPLE**

```

Console#show bridge-ext
Maximum Supported VLAN Numbers      : 4094
Maximum Supported VLAN ID           : 4094
Extended Multicast Filtering Services : No
Static Entry Individual Port         : Yes
VLAN Version Number                  : 2
VLAN Learning                         : IVL
Configurable PVID Tagging            : Yes
Local VLAN Capable                   : No
Traffic Classes                       : Enabled
Global GVRP Status                   : Disabled
GMRP                                  : Disabled
Console#

```

show garp timer This command shows the GARP timers for the selected interface.**SYNTAX****show garp timer** [*interface*]*interface***ethernet** *unit/port**unit* - Unit identifier. (Range: 1)*port* - Port number. (Range: 1-28/52)

port-channel *channel-id* (Range: 1-16)

DEFAULT SETTING

Shows all GARP timers.

COMMAND MODE

Normal Exec, Privileged Exec

EXAMPLE

```
Console#show garp timer ethernet 1/1
Eth 1/ 1 GARP Timer Status:
  Join Timer      : 20 centiseconds
  Leave Timer     : 60 centiseconds
  Leave All Timer : 1000 centiseconds
Console#
```

RELATED COMMANDS

[garp timer \(1151\)](#)

**show gvrp
configuration**

This command shows if GVRP is enabled.

SYNTAX

show gvrp configuration [*interface*]

interface

ethernet *unit/port*

unit - Unit identifier. (Range: 1)

port - Port number. (Range: 1-28/52)

port-channel *channel-id* (Range: 1-16)

DEFAULT SETTING

Shows both global and interface-specific configuration.

COMMAND MODE

Normal Exec, Privileged Exec

EXAMPLE

```
Console#show gvrp configuration ethernet 1/7
Eth 1/ 7:
  GVRP Configuration : Disabled
Console#
```

EDITING VLAN GROUPS

Table 146: Commands for Editing VLAN Groups

Command	Function	Mode
vlan database	Enters VLAN database mode to add, change, and delete VLANs	GC
vlan	Configures a VLAN, including VID, name and state	VC

vlan database This command enters VLAN database mode. All commands in this mode will take effect immediately.

DEFAULT SETTING

None

COMMAND MODE

Global Configuration

COMMAND USAGE

- ◆ Use the VLAN database command mode to add, change, and delete VLANs. After finishing configuration changes, you can display the VLAN settings by entering the [show vlan](#) command.
- ◆ Use the [interface vlan](#) command mode to define the port membership mode and add or remove ports from a VLAN. The results of these commands are written to the running-configuration file, and you can display this file by entering the [show running-config](#) command.

EXAMPLE

```
Console(config)#vlan database
Console(config-vlan)#
```

RELATED COMMANDS

[show vlan \(1164\)](#)

vlan This command configures a VLAN. Use the **no** form to restore the default settings or delete a VLAN.

SYNTAX

vlan *vlan-id* [**name** *vlan-name*] **media ethernet**
[**state** {**active** | **suspend**}] [**rspan**]

no vlan *vlan-id* [**name** | **state**]

vlan-id - VLAN ID, specified as a single number, a range of consecutive numbers separated by a hyphen, or multiple numbers separated by commas. (Range: 1-4094)

name - Keyword to be followed by the VLAN name.

vlan-name - ASCII string from 1 to 32 characters.

media ethernet - Ethernet media type.

state - Keyword to be followed by the VLAN state.

active - VLAN is operational.

suspend - VLAN is suspended. Suspended VLANs do not pass packets.

rspan - Keyword to create a VLAN used for mirroring traffic from remote switches. The VLAN used for RSPAN cannot include VLAN 1 (the switch's default VLAN). Nor should it include VLAN 4093 (which is used for switch clustering). Configuring VLAN 4093 for other purposes may cause problems in the Clustering operation. For more information on configuring RSPAN through the CLI, see "[RSPAN Mirroring Commands](#)" on page 1048.

DEFAULT SETTING

By default only VLAN 1 exists and is active.

COMMAND MODE

VLAN Database Configuration

COMMAND USAGE

- ◆ **no vlan** *vlan-id* deletes the VLAN.
- ◆ **no vlan** *vlan-id* **name** removes the VLAN name.
- ◆ **no vlan** *vlan-id* **state** returns the VLAN to the default state (i.e., active).
- ◆ You can configure up to 4094 VLANs on the switch.

EXAMPLE

The following example adds a VLAN, using VLAN ID 105 and name RD5. The VLAN is activated by default.

```
Console(config)#vlan database
Console(config-vlan)#vlan 105 name RD5 media ethernet
Console(config-vlan)#
```

RELATED COMMANDS
show vlan (1164)

CONFIGURING VLAN INTERFACES

Table 147: Commands for Configuring VLAN Interfaces

Command	Function	Mode
<code>interface vlan</code>	Enters interface configuration mode for a specified VLAN	IC
<code>switchport acceptable-frame-types</code>	Configures frame types to be accepted by an interface	IC
<code>switchport allowed vlan</code>	Configures the VLANs associated with an interface	IC
<code>switchport forbidden vlan</code>	Configures forbidden VLANs for an interface	IC
<code>switchport gvrp</code>	Enables GVRP for an interface	IC
<code>switchport ingress-filtering</code>	Enables ingress filtering on an interface	IC
<code>switchport mode</code>	Configures VLAN membership mode for an interface	IC
<code>switchport native vlan</code>	Configures the PVID (native VLAN) of an interface	IC
<code>switchport priority default</code>	Sets a port priority for incoming untagged frames	IC
<code>vlan-trunking</code>	Allows unknown VLANs to cross the switch	IC

interface vlan This command enters interface configuration mode for VLANs, which is used to configure VLAN parameters for a physical interface. Use the **no** form to change a Layer 3 normal VLAN back to a Layer 2 interface.

SYNTAX

[no] interface vlan *vlan-id*

vlan-id - ID of the configured VLAN. (Range: 1-4094)

DEFAULT SETTING

None

COMMAND MODE

Global Configuration

COMMAND USAGE

- ◆ Creating a “normal” VLAN with the `vlan` command initializes it as a Layer 2 interface. To change it to a Layer 3 interface, use the `interface` command to enter interface configuration for the desired VLAN, enter any Layer 3 configuration commands, and save the configuration settings.
- ◆ To change a Layer 3 normal VLAN back to a Layer 2 VLAN, use the `no interface` command.

EXAMPLE

The following example shows how to set the interface configuration mode to VLAN 1, and then assign an IP address to the VLAN:

```
Console(config)#interface vlan 1
Console(config-if)#ip address 192.168.1.254 255.255.255.0
Console(config-if)#
```

RELATED COMMANDS

[shutdown \(1002\)](#)

[interface \(996\)](#)

[vlan \(1156\)](#)

switchport acceptable-frame- types

This command configures the acceptable frame types for a port. Use the **no** form to restore the default.

SYNTAX

switchport acceptable-frame-types {all | tagged}

no switchport acceptable-frame-types

all - The port accepts all frames, tagged or untagged.

tagged - The port only receives tagged frames.

DEFAULT SETTING

All frame types

COMMAND MODE

Interface Configuration (Ethernet, Port Channel)

COMMAND USAGE

When set to receive all frame types, any received frames that are untagged are assigned to the default VLAN.

EXAMPLE

The following example shows how to restrict the traffic received on port 1 to tagged frames:

```
Console(config)#interface ethernet 1/1
Console(config-if)#switchport acceptable-frame-types tagged
Console(config-if)#
```

RELATED COMMANDS

[switchport mode \(1161\)](#)

switchport allowed vlan This command configures VLAN groups on the selected interface. Use the **no** form to restore the default.

SYNTAX

```
switchport allowed vlan {add vlan-list [tagged | untagged] |  
remove vlan-list}
```

no switchport allowed vlan

add *vlan-list* - List of VLAN identifiers to add.

remove *vlan-list* - List of VLAN identifiers to remove.

vlan-list - Separate nonconsecutive VLAN identifiers with a comma and no spaces; use a hyphen to designate a range of IDs. (Range: 1-4094).

DEFAULT SETTING

All ports are assigned to VLAN 1 by default.

The default frame type is untagged.

COMMAND MODE

Interface Configuration (Ethernet, Port Channel)

COMMAND USAGE

- ◆ If a port or trunk has switchport mode set to **access**, then only one VLAN can be added with this command. If a VLAN list is specified, only the last VLAN in the list will be added to the interface.
- ◆ A port, or a trunk with switchport mode set to **hybrid**, must be assigned to at least one VLAN as untagged.
- ◆ If a trunk has switchport mode set to **trunk** (i.e., 1Q Trunk), then you can only assign an interface to VLAN groups as a tagged member.
- ◆ Frames are always tagged within the switch. The tagged/untagged parameter used when adding a VLAN to an interface tells the switch whether to keep or remove the tag from a frame on egress.
- ◆ If none of the intermediate network devices nor the host at the other end of the connection supports VLANs, the interface should be added to these VLANs as an untagged member. Otherwise, it is only necessary to add at most one VLAN as untagged, and this should correspond to the native VLAN for the interface.
- ◆ If a VLAN on the forbidden list for an interface is manually added to that interface, the VLAN is automatically removed from the forbidden list for that interface.

EXAMPLE

The following example shows how to add VLANs 1, 2, 5 and 6 to the allowed list as tagged VLANs for port 1:

```
Console(config)#interface ethernet 1/1
Console(config-if)#switchport allowed vlan add 1,2,5,6 tagged
Console(config-if)#
```

switchport ingress-filtering

This command enables ingress filtering for an interface. Use the **no** form to restore the default.

SYNTAX

[no] switchport ingress-filtering

DEFAULT SETTING

Disabled

COMMAND MODE

Interface Configuration (Ethernet, Port Channel)

COMMAND USAGE

- ◆ Ingress filtering only affects tagged frames.
- ◆ If ingress filtering is disabled and a port receives frames tagged for VLANs for which it is not a member, these frames will be flooded to all other ports (except for those VLANs explicitly forbidden on this port).
- ◆ If ingress filtering is enabled and a port receives frames tagged for VLANs for which it is not a member, these frames will be discarded.
- ◆ Ingress filtering does not affect VLAN independent BPDU frames, such as GVRP or STA. However, they do affect VLAN dependent BPDU frames, such as GMRP.

EXAMPLE

The following example shows how to set the interface to port 1 and then enable ingress filtering:

```
Console(config)#interface ethernet 1/1
Console(config-if)#switchport ingress-filtering
Console(config-if)#
```

switchport mode This command configures the VLAN membership mode for a port. Use the **no** form to restore the default.

SYNTAX

switchport mode {**access** | **hybrid** | **trunk**}

no switchport mode

access - Specifies an access VLAN interface. The port transmits and receives untagged frames on a single VLAN only.

hybrid - Specifies a hybrid VLAN interface. The port may transmit tagged or untagged frames.

trunk - Specifies a port as an end-point for a VLAN trunk. A trunk is a direct link between two switches, so the port transmits tagged frames that identify the source VLAN. Note that frames belonging to the port's default VLAN (i.e., associated with the PVID) are also transmitted as tagged frames.

DEFAULT SETTING

All ports are in hybrid mode with the PVID set to VLAN 1.

COMMAND MODE

Interface Configuration (Ethernet, Port Channel)

COMMAND USAGE

Access mode is mutually exclusive with VLAN trunking (see the [vlan-trunking](#) command). If VLAN trunking is enabled on an interface, then that interface cannot be set to access mode, and vice versa.

EXAMPLE

The following shows how to set the configuration mode to port 1, and then set the switchport mode to hybrid:

```
Console(config)#interface ethernet 1/1
Console(config-if)#switchport mode hybrid
Console(config-if)#
```

RELATED COMMANDS

[switchport acceptable-frame-types \(1158\)](#)

switchport native vlan This command configures the PVID (i.e., default VLAN ID) for a port. Use the **no** form to restore the default.

SYNTAX

switchport native vlan *vlan-id*

no switchport native vlan

vlan-id - Default VLAN ID for a port. (Range: 1-4094)

DEFAULT SETTING

VLAN 1

COMMAND MODE

Interface Configuration (Ethernet, Port Channel)

COMMAND USAGE

- ◆ When using Access mode, and an interface is assigned to a new VLAN, its PVID is automatically set to the identifier for that VLAN. When using Hybrid mode, the PVID for an interface can be set to any VLAN for which it is an untagged member.
- ◆ If acceptable frame types is set to **all** or switchport mode is set to **hybrid**, the PVID will be inserted into all untagged frames entering the ingress port.

EXAMPLE

The following example shows how to set the PVID for port 1 to VLAN 3:

```
Console(config)#interface ethernet 1/1
Console(config-if)#switchport native vlan 3
Console(config-if)#
```

vlan-trunking This command allows unknown VLAN groups to pass through the specified interface. Use the **no** form to disable this feature.

SYNTAX

[no] vlan-trunking

DEFAULT SETTING

Disabled

COMMAND MODE

Interface Configuration (Ethernet, Port Channel)

COMMAND USAGE

- ◆ Use this command to configure a tunnel across one or more intermediate switches which pass traffic for VLAN groups to which they do not belong.

The following figure shows VLANs 1 and 2 configured on switches A and B, with VLAN trunking being used to pass traffic for these VLAN groups across switches C, D and E.

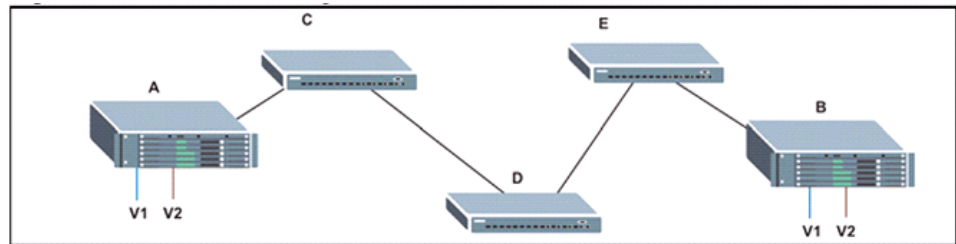
Figure 426: Configuring VLAN Trunking

Without VLAN trunking, you would have to configure VLANs 1 and 2 on all intermediate switches – C, D and E; otherwise these switches would drop any frames with unknown VLAN group tags. However, by enabling VLAN trunking on the intermediate switch ports along the path connecting VLANs 1 and 2, you only need to create these VLAN groups in switches A and B. Switches C, D and E automatically allow frames with VLAN group tags 1 and 2 (groups that are unknown to those switches) to pass through their VLAN trunking ports.

- ◆ VLAN trunking is mutually exclusive with the “access” switchport mode (see the [switchport mode](#) command). If VLAN trunking is enabled on an interface, then that interface cannot be set to access mode, and vice versa.
- ◆ To prevent loops from forming in the spanning tree, all unknown VLANs will be bound to a single instance (either STP/RSTP or an MSTP instance, depending on the selected STA mode).
- ◆ If both VLAN trunking and ingress filtering are disabled on an interface, packets with unknown VLAN tags will still be allowed to enter this interface and will be flooded to all other ports where VLAN trunking is enabled. (In other words, VLAN trunking will still be effectively enabled for the unknown VLAN).

EXAMPLE

The following example enables VLAN trunking on ports 27 and 28 to establish a path across the switch for unknown VLAN groups:

```

Console(config)#interface ethernet 1/27
Console(config-if)#vlan-trunking
Console(config-if)#interface ethernet 1/28
Console(config-if)#vlan-trunking
Console(config-if)#

```

DISPLAYING VLAN INFORMATION

This section describes commands used to display VLAN information.

Table 148: Commands for Displaying VLAN Information

Command	Function	Mode
<code>show interfaces status vlan</code>	Displays status for the specified VLAN interface	NE, PE
<code>show interfaces switchport</code>	Displays the administrative and operational status of an interface	NE, PE
<code>show vlan</code>	Shows VLAN information	NE, PE

show vlan This command shows VLAN information.

SYNTAX

show vlan [**id** *vlan-id* | **name** *vlan-name*]

id - Keyword to be followed by the VLAN ID.

vlan-id - ID of the configured VLAN. (Range: 1-4094)

name - Keyword to be followed by the VLAN name.

vlan-name - ASCII string from 1 to 32 characters.

DEFAULT SETTING

Shows all VLANs.

COMMAND MODE

Normal Exec, Privileged Exec

EXAMPLE

The following example shows how to display information for VLAN 1:

```
Console#show vlan id 1

VLAN ID:          1
Type:             Static
Name:             DefaultVlan
Status:           Active
Ports/Port Channels : Eth1/ 1(S) Eth1/ 2(S) Eth1/ 3(S) Eth1/ 4(S) Eth1/ 5(S)
                    Eth1/ 6(S) Eth1/ 7(S) Eth1/ 8(S) Eth1/ 9(S) Eth1/10(S)
                    Eth1/11(S) Eth1/12(S) Eth1/13(S) Eth1/14(S) Eth1/15(S)
                    Eth1/16(S) Eth1/17(S) Eth1/18(S) Eth1/19(S) Eth1/20(S)
                    Eth1/21(S) Eth1/22(S) Eth1/23(S) Eth1/24(S) Eth1/25(S)
                    Eth1/26(S) Eth1/27(S) Eth1/28(S) Eth1/29(S) Eth1/30(S)
                    Eth1/31(S) Eth1/32(S) Eth1/33(S) Eth1/34(S) Eth1/35(S)
                    Eth1/36(S) Eth1/37(S) Eth1/38(S) Eth1/39(S) Eth1/40(S)
                    Eth1/41(S) Eth1/42(S) Eth1/43(S) Eth1/44(S) Eth1/45(S)
                    Eth1/46(S) Eth1/47(S) Eth1/48(S) Eth1/49(S) Eth1/50(S)
                    Eth1/51(S) Eth1/52(S)

Console#
```

CONFIGURING IEEE 802.1Q TUNNELING

IEEE 802.1Q tunneling (QinQ tunneling) uses a single Service Provider VLAN (SPVLAN) for customers who have multiple VLANs. Customer VLAN IDs are preserved and traffic from different customers is segregated within the service provider's network even when they use the same customer-specific VLAN IDs. QinQ tunneling expands VLAN space by using a VLAN-in-VLAN hierarchy, preserving the customer's original tagged packets, and adding SPVLAN tags to each frame (also called double tagging).

This section describes commands used to configure QinQ tunneling.

Table 149: 802.1Q Tunneling Commands

Command	Function	Mode
<code>dot1q-tunnel system-tunnel-control</code>	Configures the switch to operate in normal mode or QinQ mode	GC
<code>switchport dot1q-tunnel mode</code>	Configures an interface as a QinQ tunnel port	IC
<code>switchport dot1q-tunnel service match cvlan</code>	Creates a CVLAN to SPVLAN mapping entry	IC
<code>switchport dot1q-tunnel tpid</code>	Sets the Tag Protocol Identifier (TPID) value of a tunnel port	IC
<code>show dot1q-tunnel</code>	Displays the configuration of QinQ tunnel ports	PE
<code>show interfaces switchport</code>	Displays port QinQ operational status	PE

General Configuration Guidelines for QinQ

1. Configure the switch to QinQ mode (`dot1q-tunnel system-tunnel-control`).
2. Create a SPVLAN (`vlan`).
3. Configure the QinQ tunnel access port to dot1Q-tunnel access mode (`switchport dot1q-tunnel mode`).
4. Set the Tag Protocol Identifier (TPID) value of the tunnel access port. This step is required if the attached client is using a nonstandard 2-byte ethertype to identify 802.1Q tagged frames. The standard ethertype value is 0x8100. (See `switchport dot1q-tunnel tpid`.)
5. Configure the QinQ tunnel access port to join the SPVLAN as an untagged member (`switchport allowed vlan`).
6. Configure the SPVLAN ID as the native VID on the QinQ tunnel access port (`switchport native vlan`).
7. Configure the QinQ tunnel uplink port to dot1Q-tunnel uplink mode (`switchport dot1q-tunnel mode`).

8. Configure the QinQ tunnel uplink port to join the SPVLAN as a tagged member ([switchport allowed vlan](#)).

Limitations for QinQ

- ◆ The native VLAN for the tunnel uplink ports and tunnel access ports cannot be the same. However, the same service VLANs can be set on both tunnel port types.
- ◆ IGMP Snooping should not be enabled on a tunnel access port.
- ◆ If the spanning tree protocol is enabled, be aware that a tunnel access or tunnel uplink port may be disabled if the spanning tree structure is automatically reconfigured to overcome a break in the tree. It is therefore advisable to disable spanning tree on these ports.

dot1q-tunnel system-tunnel- control

This command sets the switch to operate in QinQ mode. Use the **no** form to disable QinQ operating mode.

SYNTAX

[no] dot1q-tunnel system-tunnel-control

DEFAULT SETTING

Disabled

COMMAND MODE

Global Configuration

COMMAND USAGE

QinQ tunnel mode must be enabled on the switch for QinQ interface settings to be functional.

EXAMPLE

```
Console(config)#dot1q-tunnel system-tunnel-control  
Console(config)#
```

RELATED COMMANDS

[show dot1q-tunnel \(1171\)](#)
[show interfaces switchport \(1008\)](#)

switchport dot1q-tunnel mode This command configures an interface as a QinQ tunnel port. Use the **no** form to disable QinQ on the interface.

SYNTAX

switchport dot1q-tunnel mode {**access** | **uplink**}

no switchport dot1q-tunnel mode

access – Sets the port as an 802.1Q tunnel access port.

uplink – Sets the port as an 802.1Q tunnel uplink port.

DEFAULT SETTING

Disabled

COMMAND MODE

Interface Configuration (Ethernet, Port Channel)

COMMAND USAGE

- ◆ QinQ tunneling must be enabled on the switch using the [dot1q-tunnel system-tunnel-control](#) command before the **switchport dot1q-tunnel mode** interface command can take effect.
- ◆ When a tunnel uplink port receives a packet from a customer, the customer tag (regardless of whether there are one or more tag layers) is retained in the inner tag, and the service provider's tag added to the outer tag.
- ◆ When a tunnel uplink port receives a packet from the service provider, the outer service provider's tag is stripped off, and the packet passed on to the VLAN indicated by the inner tag. If no inner tag is found, the packet is passed onto the native VLAN defined for the uplink port.

EXAMPLE

```
Console(config)#interface ethernet 1/1
Console(config-if)#switchport dot1q-tunnel mode access
Console(config-if)#
```

RELATED COMMANDS

[show dot1q-tunnel \(1171\)](#)
[show interfaces switchport \(1008\)](#)

**switchport
dot1q-tunnel
service match cvid**

This command creates a CVLAN to SPVLAN mapping entry. Use the **no** form to delete a VLAN mapping entry.

SYNTAX

switchport dot1q-tunnel service *svid* match cvid *cvid*

svid - VLAN ID for the outer VLAN tag (Service Provider VID).
(Range: 1-4094)

cvid - VLAN ID for the inner VLAN tag (Customer VID).
(Range: 1-4094)

DEFAULT SETTING

Default mapping uses the PVID of the ingress port on the edge router for the SPVID.

COMMAND MODE

Interface Configuration (Ethernet, Port Channel)

COMMAND USAGE

- ◆ The inner VLAN tag of a customer packet entering the edge router of a service provider's network is mapped to an outer tag indicating the service provider VLAN that will carry this traffic across the 802.1Q tunnel. This process is performed in a transparent manner as described under "[IEEE 802.1Q Tunneling](#)" on page 212.
- ◆ When priority bits are found in the inner tag, these are also copied to the outer tag. This allows the service provider to differentiate service based on the indicated priority and appropriate methods of queue management at intermediate nodes across the tunnel.
- ◆ Rather than relying on standard service paths and priority queuing, QinQ VLAN mapping can be used to further enhance service by defining a set of differentiated service pathways to follow across the service provider's network for traffic arriving from specified inbound customer VLANs.
- ◆ Note that all customer interfaces should be configured as access interfaces (that is, a user-to-network interface) and service provider interfaces as uplink interfaces (that is, a network-to-network interface). Use the [switchport dot1q-tunnel mode uplink](#) command to set an interface to access or uplink mode.

EXAMPLE

This example sets the SVID to 99 in the outer tag for egress packets exiting port 1 when the packet's CVID is 2.

```
Console(config)#interface ethernet 1/1
Console(config-if)#switchport dot1q-tunnel service 99 match cvid 2
Console(config-if)#
```

The following example maps C-VLAN 10 to S-VLAN 100, C-VLAN 20 to S-VLAN 200 and C-VLAN 30 to S-VLAN 300 for ingress traffic on port 1 of Switches A and B.

Figure 427: Mapping QinQ Service VLAN to Customer VLAN

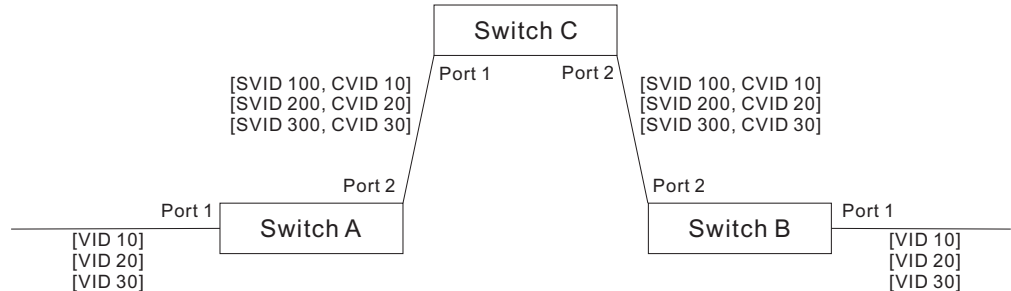

Step 1. Configure Switch A and B.

1. Create VLANs 100, 200 and 300.

```
Console(config)#vlan database
Console(config-vlan)#vlan 100,200,300 media ethernet state active
```

2. Enable QinQ.

```
Console(config)#dot1q-tunnel system-tunnel-control
```

3. Configure port 2 as a tagged member of VLANs 100, 200 and 300 using uplink mode.

```
Console(config)#interface ethernet 1/2
Console(config-if)#switchport allowed vlan add 100,200,300 tagged
Console(config-if)#switchport dot1q-tunnel mode uplink
```

4. Configures port 1 as an untagged member of VLANs 100, 200 and 300 using access mode.

```
Console(config)#interface ethernet 1/1
Console(config-if)#switchport allowed vlan add 100,200,300 untagged
Console(config-if)#switchport dot1q-tunnel mode access
```

5. Configure the following selective QinQ mapping entries.

```
Console(config)#interface ethernet 1/1
Console(config-if)#switchport dot1q-tunnel service 100 match cvid 10
Console(config-if)#switchport dot1q-tunnel service 200 match cvid 20
Console(config-if)#switchport dot1q-tunnel service 300 match cvid 30
```

6. Configures port 1 as member of VLANs 10, 20 and 30 to avoid filtering out incoming frames tagged with VID 10, 20 or 30 on port 1

```
Console(config)#interface ethernet 1/1
Console(config-if)#switchport allowed vlan add 10,20,30
```

7. Verify configuration settings.

```
Console#show dot1q-tunnel service
802.1Q Tunnel Service Subscriptions
```

Port	Match	C-VID	S-VID
Eth 1/ 1		10	100
Eth 1/ 1		20	200
Eth 1/ 1		30	300

Step 2. Configure Switch C.

1. Create VLAN 100, 200 and 300.

```
Console(config)#vlan database  
Console(config-vlan)#vlan 100,200,300 media ethernet state active
```

2. Configure port 1 and port 2 as tagged members of VLAN 100, 200 and 300.

```
Console(config)#interface ethernet 1/1,2  
Console(config-if)#switchport allowed vlan add 100,200,300 tagged
```

switchport dot1q-tunnel tpid This command sets the Tag Protocol Identifier (TPID) value of a tunnel port. Use the **no** form to restore the default setting.

SYNTAX

switchport dot1q-tunnel tpid *tpid*

no switchport dot1q-tunnel tpid

tpid – Sets the ethertype value for 802.1Q encapsulation. This identifier is used to select a nonstandard 2-byte ethertype to identify 802.1Q tagged frames. The standard ethertype value is 0x8100. (Range: 0800-FFFF hexadecimal)

DEFAULT SETTING

0x8100

COMMAND MODE

Interface Configuration (Ethernet, Port Channel)

COMMAND USAGE

- ◆ Use the **switchport dot1q-tunnel tpid** command to set a custom 802.1Q ethertype value on the selected interface. This feature allows the switch to interoperate with third-party switches that do not use the standard 0x8100 ethertype to identify 802.1Q-tagged frames. For example, 0x1234 is set as the custom 802.1Q ethertype on a trunk port, incoming frames containing that ethertype are assigned to the VLAN contained in the tag following the ethertype field, as they would be with a standard 802.1Q trunk. Frames arriving on the port containing any other ethertype are looked upon as untagged frames, and assigned to the native VLAN of that port.
- ◆ The specified ethertype only applies to ports configured in Uplink mode using the [switchport dot1q-tunnel mode](#) command. If the port is in normal mode (i.e, unspecified), the TPID is always 8100. If the port is in Access mode, received packets are processed as untagged packets.

EXAMPLE

```
Console(config)#interface ethernet 1/1  
Console(config-if)#switchport dot1q-tunnel tpid 9100  
Console(config-if)#
```

RELATED COMMANDS[show interfaces switchport \(1008\)](#)**show dot1q-tunnel** This command displays information about QinQ tunnel ports.**SYNTAX****show dot1q-tunnel** [**interface** *interface* [**service** *svid*] | **service** [*svid*]]*interface***ethernet** *unit/port**unit* - Stack unit. (Range: 1)*port* - Port number. (Range: 1-28/52)**port-channel** *channel-id* (Range: 1-16)*svid* - VLAN ID for the outer VLAN tag (SPVID). (Range: 1-4094)**COMMAND MODE**

Privileged Exec

EXAMPLE

```

Console(config)#dot1q-tunnel system-tunnel-control
Console(config)#interface ethernet 1/1
Console(config-if)#switchport dot1q-tunnel mode access
Console(config-if)#interface ethernet 1/2
Console(config-if)#switchport dot1q-tunnel mode uplink
Console(config-if)#end
Console#show dot1q-tunnel
802.1Q Tunnel Status : Enabled

Port      Mode  TPID (hex)
-----  -
Eth 1/ 1 Access      8100
Eth 1/ 2 Uplink      8100
Eth 1/ 3 Normal      8100
:
:
Console#show dot1q-tunnel interface ethernet 1/5
802.1Q Tunnel Service Subscriptions

Port      Match C-VID S-VID
-----  -
Eth 1/ 5          1  100

Console#show dot1q-tunnel service 100
802.1Q Tunnel Service Subscriptions

Port      Match C-VID S-VID
-----  -
Eth 1/ 5          1  100
Eth 1/ 6          1  100

Console#

```

RELATED COMMANDS[switchport dot1q-tunnel mode \(1167\)](#)

CONFIGURING L2CP TUNNELING

This section describes the commands used to configure Layer 2 Protocol Tunneling (L2PT).

Table 150: L2 Protocol Tunnel Commands

Command	Function	Mode
<code>l2protocol-tunnel tunnel-dmac</code>	Configures the destination address for Layer 2 Protocol Tunneling	GC
<code>switchport l2protocol-tunnel</code>	Enables Layer 2 Protocol Tunneling for the specified protocol	IC
<code>show l2protocol-tunnel</code>	Shows settings for Layer 2 Protocol Tunneling	PE

l2protocol-tunnel tunnel-dmac This command configures the destination address for Layer 2 Protocol Tunneling (L2PT). Use the **no** form to restore the default setting.

SYNTAX

l2protocol-tunnel tunnel-dmac *mac-address*

mac-address – The switch rewrites the destination MAC address in all upstream L2PT protocol packets (i.e, STP BPDUs) to this value, and forwards them on to uplink ports. The MAC address must be specified in the format xx-xx-xx-xx-xx-xx or xxxxxxxxxxxx.

DEFAULT SETTING

01-12-CF-.00-00-02, proprietary tunnel address

COMMAND MODE

Global Configuration

COMMAND USAGE

- ◆ When L2PT is not used, protocol packets (such as STP) are flooded to 802.1Q access ports on the same edge switch, but filtered from 802.1Q tunnel ports. This creates disconnected protocol domains in the customer’s network.
- ◆ L2PT can be used to pass various types of protocol packets belonging to the same customer transparently across a service provider’s network. In this way, normally segregated network segments can be configured to function inside a common protocol domain.
- ◆ L2PT encapsulates protocol packets entering ingress ports on the service provider’s edge switch, replacing the destination MAC address with a proprietary MAC address (for example, the spanning tree protocol uses 10-12-CF-00-00-02), a reserved address for other specified protocol types (as defined in IEEE 802.1ad – Provider Bridges), or a user-defined address. All intermediate switches carrying this traffic across the service provider’s network treat these encapsulated packets in the same way as normal data, forwarding

them across to the tunnel's egress port. The egress port decapsulates these packets, restores the proper protocol and MAC address information, and then floods them onto the same VLANs at the customer's remote site (via all of the appropriate tunnel ports and access ports³⁰ connected to the same metro VLAN).

- ◆ The way in which L2PT processes packets is based on the following criteria – (1) packet is received on a QinQ uplink port, (2) packet is received on a QinQ access port, or (3) received packet is Cisco-compatible L2PT (i.e., as indicated by a proprietary MAC address).

Processing protocol packets defined in IEEE 802.1ad – Provider Bridges

- ◆ When an IEEE 802.1ad protocol packet is received on an uplink port (i.e., an 802.1Q tunnel ingress port connecting the edge switch to the service provider network)
 - with the destination address 01-80-C2-00-00-00,0B~0F (C-VLAN tag), it is forwarded to all QinQ uplink ports and QinQ access ports in the same S-VLAN for which L2PT is enabled for that protocol.
 - with the destination address 01-80-C2-00-00-01~0A (S-VLAN tag), it is filtered, decapsulated, and processed locally by the switch if the protocol is supported.
- ◆ When a protocol packet is received on an access port (i.e., an 802.1Q trunk port connecting the edge switch to the local customer network)
 - with the destination address 01-80-C2-00-00-00,0B~0F (C-VLAN), and
 - L2PT is enabled on the port, the frame is forwarded to all QinQ uplink ports and QinQ access ports on which L2PT is enabled for that protocol in the same S-VLAN.
 - L2PT is disabled on the port, the frame is decapsulated and processed locally by the switch if the protocol is supported.
 - with destination address 01-80-C2-00-00-01~0A (S-VLAN), the frame is filtered, decapsulated, and processed locally by the switch if the protocol is supported.

Processing Cisco-compatible protocol packets

- ◆ When a Cisco-compatible L2PT packet is received on an uplink port, and
 - recognized as a CDP/VTP/STP/PVST+ protocol packet (where STP means STP/RSTP/MSTP), it is forwarded to the following ports in the same S-VLAN: (a) all access ports for which L2PT has been disabled, and (b) all uplink ports.
 - recognized as a Generic Bridge PDU Tunneling (GBPT) protocol packet (i.e., having the destination address 01-00-0C-CD-CD-D0), it is forwarded to the following ports in the same S-VLAN:

30. Access ports in this context are 802.1Q trunk ports.

- other access ports for which L2PT is enabled after decapsulating the packet and restoring the proper protocol and MAC address information.
- all uplink ports.
- ◆ When a Cisco-compatible L2PT packet is received on an access port, and
 - recognized as a CDP/VTP/STP/PVST+ protocol packet, and
 - L2PT is enabled on this port, it is forwarded to the following ports in the same S-VLAN: (a) other access ports for which L2PT is enabled, and (b) uplink ports after rewriting the destination address to make it a GBPT protocol packet (i.e., setting the destination address to 01-00-0C-CD-CD-D0).
 - L2PT is disabled on this port, it is forwarded to the following ports in the same S-VLAN: (a) other access ports for which L2PT is disabled, and (b) all uplink ports.
 - recognized as a GBPT protocol packet (i.e., having the destination address 01-00-0C-CD-CD-D0), and
 - L2PT is enabled on this port, it is forwarded to other access ports in the same S-VLAN for which L2PT is enabled
 - L2PT is disabled on this port, it is forwarded to the following ports in the same S-VLAN: (a) other access ports for which L2PT is disabled, and (b) all uplink ports.
- ◆ For L2PT to function properly, QinQ must be enabled on the switch using the `dot1q-tunnel system-tunnel-control` command, and the interface configured to 802.1Q tunnel mode using the `switchport dot1q-tunnel mode` command.

EXAMPLE

```
Console(config)#dot1q-tunnel system-tunnel-control
Console(config)#l2protocol-tunnel tunnel-dmac 01-80-C2-00-00-01
Console(config)#
```

switchport l2protocol-tunnel This command enables Layer 2 Protocol Tunneling (L2PT) for the specified protocol. Use the **no** form to disable L2PT for the specified protocol.

SYNTAX

switchport l2protocol-tunnel {**cdp** | **lldp** | **pvst+** | **spanning-tree** | **vtp**}

cdp - Cisco Discovery Protocol

lldp - Link Layer Discovery Protocol

pvst+ - Cisco Per VLAN Spanning Tree Plus

spanning-tree - Spanning Tree (STP, RSTP, MSTP)

vtp - Cisco VLAN Trunking Protocol

DEFAULT SETTING

Disabled for all protocols

COMMAND MODE

Interface Configuration (Ethernet, Port Channel)

COMMAND USAGE

- ◆ Refer to the Command Usage section for the [l2protocol-tunnel tunnel-dmac](#) command.
- ◆ For L2PT to function properly, QinQ must be enabled on the switch using the [dot1q-tunnel system-tunnel-control](#) command, and the interface configured to 802.1Q tunnel mode using the [switchport dot1q-tunnel mode](#) command.

EXAMPLE

```
Console(config)#dot1q-tunnel system-tunnel-control
Console(config)#interface ethernet 1/1
Console(config-if)#switchport dot1q-tunnel mode access
Console(config-if)#switchport l2protocol-tunnel spanning-tree
Console(config-if)#
```

show l2protocol-tunnel This command shows settings for Layer 2 Protocol Tunneling (L2PT).

COMMAND MODE

Privileged Exec

EXAMPLE

```
Console#show l2protocol-tunnel
Layer 2 Protocol Tunnel

Tunnel MAC Address : 01-12-CF-00-00-00

Interface Protocol
-----
Eth 1/ 1   Spanning Tree
```

Console#

CONFIGURING VLAN TRANSLATION

QinQ tunneling uses double tagging to preserve the customer's VLAN tags on traffic crossing the service provider's network. However, if any switch in the path crossing the service provider's network does not support this feature, then the switches directly connected to that device can be configured to swap the customer's VLAN ID with the service provider's VLAN ID for upstream traffic, or the service provider's VLAN ID with the customer's VLAN ID for downstream traffic.

This section describes commands used to configure VLAN translation.

Table 151: VLAN Translation Commands

Command	Function	Mode
<code>switchport vlan-translation</code>	Maps VLAN IDs between the customer and service provider	IC
<code>show vlan-translation</code>	Displays the configuration settings for VLAN translation	PE

switchport vlan-translation This command maps VLAN IDs between the customer and service provider.

SYNTAX

switchport vlan-translation *original-vlan new-vlan*

no switchport vlan-translation *original-vlan*

original-vlan - The original VLAN ID. (Range: 1-4094)

new-vlan - The new VLAN ID. (Range: 1-4094)

DEFAULT SETTING

Disabled

COMMAND MODE

Interface Configuration (Ethernet)

COMMAND USAGE

- ◆ If the next switch upstream does not support QinQ tunneling, then use this command to map the customer's VLAN ID to the service provider's VLAN ID for the upstream port. Similarly, if the next switch downstream does not support QinQ tunneling, then use this command to map the service provider's VLAN ID to the customer's VLAN ID for the downstream port. Note that one command maps both the *original-vlan* to *new-vlan* for ingress traffic and the *new-vlan* to *original-vlan* for egress traffic on the specified port.

For example, assume that the upstream switch does not support QinQ tunneling. If the command **switchport vlan-translation 10 100** is used to map VLAN 10 to VLAN 100 for upstream traffic entering port 1, and VLAN 100 to VLAN 10 for downstream traffic leaving port 1, then the VLAN IDs will be swapped as shown below.

Figure 428: Configuring VLAN Translation

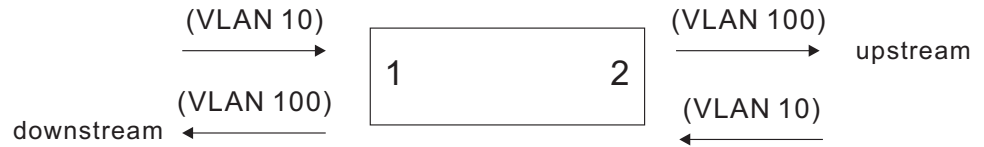

- ◆ The maximum number of VLAN translation entries is 8 per port, and up to 96 for the system. However, note that configuring a large number of entries may degrade the performance of other processes that also use the TCAM, such as IP Source Guard filter rules, Quality of Service (QoS) processes, QinQ, MAC-based VLANs, VLAN translation, or traps.
- ◆ If VLAN translation is set on an interface with this command, and the same interface is also configured as a QinQ access port with the [switchport dot1q-tunnel mode](#) command, VLAN tag assignments will be determined by the QinQ process, not by VLAN translation.

EXAMPLE

This example configures VLAN translation for Port 1 as described in the Command Usage section above.

```

Console(config)#vlan database
Console(config-vlan)#vlan 10 media ethernet state active
Console(config-vlan)#vlan 100 media ethernet state active
Console(config-vlan)#exit
Console(config)#interface ethernet 1/1,2
Console(config-if)#switchport allowed vlan add 10 tagged
Console(config-if)#switchport allowed vlan add 100 tagged
Console(config-if)#interface ethernet 1/1
Console(config-if)#switchport vlan-translation 10 100
Console(config-if)#end
Console#show vlan-translation

Interface Old VID New VID
-----
Eth 1/ 1      10    100

Console#

```

show vlan-translation This command displays the configuration settings for VLAN translation.

SYNTAX

```
show vlan-translation [interface interface]  
interface  
ethernet unit/port  
unit - Stack unit. (Range: 1)  
port - Port number. (Range: 1-28/52)
```

COMMAND MODE

Privileged Exec

EXAMPLE

```
Console#show vlan-translation  
  
Interface Old VID New VID  
-----  
Eth 1/ 1      10    100  
  
Console#
```

CONFIGURING PROTOCOL-BASED VLANs

The network devices required to support multiple protocols cannot be easily grouped into a common VLAN. This may require non-standard devices to pass traffic between different VLANs in order to encompass all the devices participating in a specific protocol. This kind of configuration deprives users of the basic benefits of VLANs, including security and easy accessibility.

To avoid these problems, you can configure this switch with protocol-based VLANs that divide the physical network into logical VLAN groups for each required protocol. When a frame is received at a port, its VLAN membership can then be determined based on the protocol type in use by the inbound packets.

Table 152: Protocol-based VLAN Commands

Command	Function	Mode
protocol-vlan protocol-group	Create a protocol group, specifying the supported protocols	GC
protocol-vlan protocol-group	Maps a protocol group to a VLAN	IC
show protocol-vlan protocol-group	Shows the configuration of protocol groups	PE
show interfaces protocol-vlan protocol-group	Shows the interfaces mapped to a protocol group and the corresponding VLAN	PE

To configure protocol-based VLANs, follow these steps:

1. First configure VLAN groups for the protocols you want to use (page 1156). Although not mandatory, we suggest configuring a separate VLAN for each major protocol running on your network. Do not add port members at this time.
2. Create a protocol group for each of the protocols you want to assign to a VLAN using the `protocol-vlan protocol-group` command (Global Configuration mode).
3. Then map the protocol for each interface to the appropriate VLAN using the `protocol-vlan protocol-group` command (Interface Configuration mode).

protocol-vlan protocol-group (Configuring Groups)

This command creates a protocol group, or to add specific protocols to a group. Use the **no** form to remove a protocol group.

SYNTAX

```
protocol-vlan protocol-group group-id [{add | remove}  
frame-type frame protocol-type protocol]
```

```
no protocol-vlan protocol-group group-id
```

group-id - Group identifier of this protocol group.
(Range: 1-2147483647)

*frame*³¹ - Frame type used by this protocol. (Options: ethernet, rfc_1042, llc_other)

protocol - Protocol type. The only option for the llc_other frame type is ipx_raw. The options for all other frames types include: arp, ip, ipv6, rarp.

DEFAULT SETTING

No protocol groups are configured.

COMMAND MODE

Global Configuration

EXAMPLE

The following creates protocol group 1, and specifies Ethernet frames with IP and ARP protocol types:

```
Console(config)#protocol-vlan protocol-group 1 add frame-type ethernet  
protocol-type ip  
Console(config)#protocol-vlan protocol-group 1 add frame-type ethernet  
protocol-type arp  
Console(config)#
```

31. SNAP frame types are not supported by this switch due to hardware limitations.

protocol-vlan
protocol-group
(Configuring Interfaces)

This command maps a protocol group to a VLAN for the current interface. Use the **no** form to remove the protocol mapping for this interface.

SYNTAX

```
protocol-vlan protocol-group group-id vlan vlan-id  
[priority priority]
```

```
no protocol-vlan protocol-group group-id vlan
```

group-id - Group identifier of this protocol group.
(Range: 1-2147483647)

vlan-id - VLAN to which matching protocol traffic is forwarded.
(Range: 1-4094)

priority - The priority assigned to untagged ingress traffic.
(Range: 0-7, where 7 is the highest priority)

DEFAULT SETTING

No protocol groups are mapped for any interface.
Priority: 0

COMMAND MODE

Interface Configuration (Ethernet, Port Channel)

COMMAND USAGE

- ◆ When creating a protocol-based VLAN, only assign interfaces via this command. If you assign interfaces using any of the other VLAN commands (such as the **vlan** command), these interfaces will admit traffic of any protocol type into the associated VLAN.
- ◆ When MAC-based, IP subnet-based, and protocol-based VLANs are supported concurrently, priority is applied in this sequence, and then port-based VLANs last.
- ◆ When a frame enters a port that has been assigned to a protocol VLAN, it is processed in the following manner:
 - If the frame is tagged, it will be processed according to the standard rules applied to tagged frames.
 - If the frame is untagged and the protocol type matches, the frame is forwarded to the appropriate VLAN.
 - If the frame is untagged but the protocol type does not match, the frame is forwarded to the default VLAN for this interface.

EXAMPLE

The following example maps the traffic entering Port 1 which matches the protocol type specified in protocol group 1 to VLAN 2.

```
Console(config)#interface ethernet 1/1
Console(config-if)#protocol-vlan protocol-group 1 vlan 2
Console(config-if)#
```

**show protocol-vlan
protocol-group**

This command shows the frame and protocol type associated with protocol groups.

SYNTAX

show protocol-vlan protocol-group [*group-id*]

group-id - Group identifier for a protocol group.
(Range: 1-2147483647)

DEFAULT SETTING

All protocol groups are displayed.

COMMAND MODE

Privileged Exec

EXAMPLE

This shows protocol group 1 configured for IP over Ethernet:

```
Console#show protocol-vlan protocol-group

Protocol Group ID  Frame Type  Protocol Type
-----
                  1          ethernet    08 00
Console#
```

**show interfaces
protocol-vlan
protocol-group**

This command shows the mapping from protocol groups to VLANs for the selected interfaces.

SYNTAX

show interfaces protocol-vlan protocol-group [*interface*]

interface

ethernet *unit/port*

unit - Unit identifier. (Range: 1)

port - Port number. (Range: 1-28/52)

port-channel *channel-id* (Range: 1-16)

DEFAULT SETTING

The mapping for all interfaces is displayed.

COMMAND MODE

Privileged Exec

EXAMPLE

This shows that traffic entering Port 1 that matches the specifications for protocol group 1 will be mapped to VLAN 2:

```
Console#show interfaces protocol-vlan protocol-group

  Port      ProtocolGroup ID  VLAN ID
-----
  Eth 1/1           1      vlan2
Console#
```

CONFIGURING IP SUBNET VLANS

When using IEEE 802.1Q port-based VLAN classification, all untagged frames received by a port are classified as belonging to the VLAN whose VID (PVID) is associated with that port.

When IP subnet-based VLAN classification is enabled, the source address of untagged ingress frames are checked against the IP subnet-to-VLAN mapping table. If an entry is found for that subnet, these frames are assigned to the VLAN indicated in the entry. If no IP subnet is matched, the untagged frames are classified as belonging to the receiving port's VLAN ID (PVID).

Table 153: IP Subnet VLAN Commands

Command	Function	Mode
subnet-vlan	Defines the IP Subnet VLANs	GC
show subnet-vlan	Displays IP Subnet VLAN settings	PE

subnet-vlan This command configures IP Subnet VLAN assignments. Use the **no** form to remove an IP subnet-to-VLAN assignment.

SYNTAX

subnet-vlan subnet *ip-address mask* **vlan** *vlan-id* [**priority** *priority*]

no subnet-vlan subnet {*ip-address mask* | **all**}

ip-address – The IP address that defines the subnet. Valid IP addresses consist of four decimal numbers, 0 to 255, separated by periods.

mask – This mask identifies the host address bits of the IP subnet.

vlan-id – VLAN to which matching IP subnet traffic is forwarded. (Range: 1-4094)

priority – The priority assigned to untagged ingress traffic. (Range: 0-7, where 7 is the highest priority)

DEFAULT SETTING

Priority: 0

COMMAND MODE

Global Configuration

COMMAND USAGE

- ◆ Each IP subnet can be mapped to only one VLAN ID. An IP subnet consists of an IP address and a subnet mask. The specified VLAN need not be an existing VLAN.
- ◆ When an untagged frame is received by a port, the source IP address is checked against the IP subnet-to-VLAN mapping table, and if an entry is found, the corresponding VLAN ID is assigned to the frame. If no mapping is found, the PVID of the receiving port is assigned to the frame.
- ◆ The IP subnet cannot be a broadcast or multicast IP address.
- ◆ When MAC-based, IP subnet-based, or protocol-based VLANs are supported concurrently, priority is applied in this sequence, and then port-based VLANs last.

EXAMPLE

The following example assigns traffic for the subnet 192.168.12.192, mask 255.255.255.224, to VLAN 4.

```
Console(config)#subnet-vlan subnet 192.168.12.192 255.255.255.224 vlan 4
Console(config)#
```

show subnet-vlan This command displays IP Subnet VLAN assignments.

COMMAND MODE
Privileged Exec

COMMAND USAGE

- ◆ Use this command to display subnet-to-VLAN mappings.
- ◆ The last matched entry is used if more than one entry can be matched.

EXAMPLE

The following example displays all configured IP subnet-based VLANs.

```
Console#show subnet-vlan
IP Address      Mask                VLAN ID  Priority
-----
192.168.12.0    255.255.255.128    1        0
192.168.12.128 255.255.255.192    3        0
192.168.12.192 255.255.255.224    4        0
192.168.12.224 255.255.255.240    5        0
192.168.12.240 255.255.255.248    6        0
192.168.12.248 255.255.255.252    7        0
192.168.12.252 255.255.255.254    8        0
192.168.12.254 255.255.255.255    9        0
192.168.12.255 255.255.255.255    10       0
Console#
```

CONFIGURING MAC BASED VLANs

When using IEEE 802.1Q port-based VLAN classification, all untagged frames received by a port are classified as belonging to the VLAN whose VID (PVID) is associated with that port.

When MAC-based VLAN classification is enabled, the source address of untagged ingress frames are checked against the MAC address-to-VLAN mapping table. If an entry is found for that address, these frames are assigned to the VLAN indicated in the entry. If no MAC address is matched, the untagged frames are classified as belonging to the receiving port's VLAN ID (PVID).

Table 154: MAC Based VLAN Commands

Command	Function	Mode
mac-vlan	Defines the IP Subnet VLANs	GC
show mac-vlan	Displays IP Subnet VLAN settings	PE

mac-vlan This command configures MAC address-to-VLAN mapping. Use the **no** form to remove an assignment.

SYNTAX

mac-vlan mac-address mac-address [**mask mask-address**]
vlan vlan-id [**priority priority**]

no mac-vlan mac-address {*mac-address* | **all**}

mac-address – The source MAC address to be matched. Configured MAC addresses can only be unicast addresses. The MAC address must be specified in the format xx-xx-xx-xx-xx-xx or xxxxxxxxxxxx.

mask-address - Identifies a range of MAC addresses.
(Range: 00-00-00-00-00-00 to FF-FF-FF-FF-FF-FF)

vlan-id – VLAN to which the matching source MAC address traffic is forwarded. (Range: 1-4094)

priority – The priority assigned to untagged ingress traffic.
(Range: 0-7, where 7 is the highest priority)

DEFAULT SETTING

None

COMMAND MODE

Global Configuration

COMMAND USAGE

- ◆ The MAC-to-VLAN mapping applies to all ports on the switch.
- ◆ Source MAC addresses can be mapped to only one VLAN ID.
- ◆ Configured MAC addresses cannot be broadcast or multicast addresses.
- ◆ When MAC-based, IP subnet-based, and protocol-based VLANs are supported concurrently, priority is applied in this sequence, and then port-based VLANs last.

- ◆ The binary equivalent mask matching the characters in the front of the first non-zero character must all be 1s (e.g., 111, i.e., it cannot be 101 or 001...). A mask for the MAC address: 00-50-6e-00-5f-b1 translated into binary:

MAC: 00000000-01010000-01101110-00000000-01011111-10110001
could be: 11111111-11xxxxxx-xxxxxxxx-xxxxxxxx-xxxxxxxx-xxxxxxxx

So the mask in hexadecimal for this example could be:

ff-fx-xx-xx-xx-xx/ff-c0-00-00-00-00/ff-e0-00-00-00-00

EXAMPLE

The following example assigns traffic from source MAC address 00-00-00-11-22-33 to VLAN 10.

```
Console(config)#mac-vlan mac-address 00-00-00-11-22-33 vlan 10
Console(config)#
```

show mac-vlan This command displays MAC address-to-VLAN assignments.

COMMAND MODE

Privileged Exec

COMMAND USAGE

Use this command to display MAC address-to-VLAN mappings.

EXAMPLE

The following example displays all configured MAC address-based VLANs.

```
Console#show mac-vlan
MAC Address          VLAN ID  Priority
-----
00-00-00-11-22-33   10      0
Console#
```

CONFIGURING VOICE VLANS

The switch allows you to specify a Voice VLAN for the network and set a CoS priority for the VoIP traffic. VoIP traffic can be detected on switch ports by using the source MAC address of packets, or by using LLDP (IEEE 802.1AB) to discover connected VoIP devices. When VoIP traffic is detected on a configured port, the switch automatically assigns the port to the Voice VLAN. Alternatively, switch ports can be manually configured.

Table 155: Voice VLAN Commands

Command	Function	Mode
<code>voice vlan</code>	Defines the Voice VLAN ID	GC
<code>voice vlan aging</code>	Configures the aging time for Voice VLAN ports	GC
<code>voice vlan mac-address</code>	Configures VoIP device MAC addresses	GC
<code>switchport voice vlan</code>	Sets the Voice VLAN port mode	IC
<code>switchport voice vlan priority</code>	Sets the VoIP traffic priority for ports	IC
<code>switchport voice vlan rule</code>	Sets the automatic VoIP traffic detection method for ports	IC

Table 155: Voice VLAN Commands (Continued)

Command	Function	Mode
<code>switchport voice vlan security</code>	Enables Voice VLAN security on ports	IC
<code>show voice vlan</code>	Displays Voice VLAN settings	PE

voice vlan This command enables VoIP traffic detection and defines the Voice VLAN ID. Use the **no** form to disable the Voice VLAN.

SYNTAX

voice vlan *voice-vlan-id*

no voice vlan

voice-vlan-id - Specifies the voice VLAN ID. (Range: 1-4094)

DEFAULT SETTING

Disabled

COMMAND MODE

Global Configuration

COMMAND USAGE

- ◆ When IP telephony is deployed in an enterprise network, it is recommended to isolate the Voice over IP (VoIP) network traffic from other data traffic. Traffic isolation helps prevent excessive packet delays, packet loss, and jitter, which results in higher voice quality. This is best achieved by assigning all VoIP traffic to a single VLAN.
- ◆ VoIP traffic can be detected on switch ports by using the source MAC address of packets, or by using LLDP (IEEE 802.1AB) to discover connected VoIP devices. When VoIP traffic is detected on a configured port, the switch automatically assigns the port as a tagged member of the Voice VLAN.
- ◆ Only one Voice VLAN is supported and it must already be created on the switch before it can be specified as the Voice VLAN.
- ◆ The Voice VLAN ID cannot be modified when the global auto-detection status is enabled (see the `switchport voice vlan` command).

EXAMPLE

The following example enables VoIP traffic detection and specifies the Voice VLAN ID as 1234.

```
Console(config)#voice vlan 1234
Console(config)#
```

voice vlan aging This command sets the Voice VLAN ID time out. Use the **no** form to restore the default.

SYNTAX

voice vlan aging *minutes*

no voice vlan

minutes - Specifies the port Voice VLAN membership time out.
(Range: 5-43200 minutes)

DEFAULT SETTING

1440 minutes

COMMAND MODE

Global Configuration

COMMAND USAGE

The Voice VLAN aging time is the time after which a port is removed from the Voice VLAN when VoIP traffic is no longer received on the port.

The VoIP aging time starts to count down when the OUI's MAC address expires from the MAC address table. Therefore, the MAC address aging time should be added to the overall aging time. For example, if you configure the MAC address table aging time to 30 seconds, and voice VLAN aging time to 5 minutes, then after 5.5 minutes, a port will be removed from the voice VLAN when VoIP traffic is no longer received on the port. Alternatively, if you clear the MAC address table manually, then the switch will also start counting down the voice VLAN aging time.

EXAMPLE

The following example configures the Voice VLAN aging time as 3000 minutes.

```
Console(config)#voice vlan aging 3000  
Console(config)#
```

voice vlan mac-address This command specifies MAC address ranges to add to the OUI Telephony list. Use the **no** form to remove an entry from the list.

SYNTAX

voice vlan mac-address *mac-address* **mask** *mask-address*
[**description** *description*]

no voice vlan mac-address *mac-address* **mask** *mask-address*

mac-address - Defines a MAC address OUI that identifies VoIP devices in the network. (Format: xx-xx-xx-xx-xx-xx or xxxxxxxxxxxx; for example, 01-23-45-00-00-00)

mask-address - Identifies a range of MAC addresses. (Format: xx-xx-xx-xx-xx-xx or xxxxxxxxxxxx; Range: 80-00-00-00-00-00 to FF-FF-FF-FF-FF-FF)

description - User-defined text that identifies the VoIP devices. (Range: 1-32 characters)

DEFAULT SETTING

None

COMMAND MODE

Global Configuration

COMMAND USAGE

- ◆ VoIP devices attached to the switch can be identified by the manufacturer's Organizational Unique Identifier (OUI) in the source MAC address of received packets. OUI numbers are assigned to manufacturers and form the first three octets of device MAC addresses. The MAC OUI numbers for VoIP equipment can be configured on the switch so that traffic from these devices is recognized as VoIP.
- ◆ Setting a mask of FF-FF-FF-00-00-00 identifies all devices with the same OUI (the first three octets). Other masks restrict the MAC address range. Setting a mask of FF-FF-FF-FF-FF-FF specifies a single MAC address.

EXAMPLE

The following example adds a MAC OUI to the OUI Telephony list.

```
Console(config)#voice vlan mac-address 00-12-34-56-78-90 mask ff-ff-ff-00-00-00-00 description A new phone
Console(config)#
```

switchport voice vlan This command specifies the Voice VLAN mode for ports. Use the **no** form to disable the Voice VLAN feature on the port.

SYNTAX

switchport voice vlan {manual | auto}

no switchport voice vlan

manual - The Voice VLAN feature is enabled on the port, but the port must be manually added to the Voice VLAN.

auto - The port will be added as a tagged member to the Voice VLAN when VoIP traffic is detected on the port.

DEFAULT SETTING

Disabled

COMMAND MODE

Interface Configuration

COMMAND USAGE

- ◆ When auto is selected, you must select the method to use for detecting VoIP traffic, either OUI or 802.1AB (LLDP) using the **switchport voice vlan rule** command. When OUI is selected, be sure to configure the MAC address ranges in the Telephony OUI list using the **voice vlan mac-address** command.
- ◆ All ports are set to VLAN hybrid mode by default. Prior to enabling VoIP for a port (by setting the VoIP mode to Auto or Manual as described below), ensure that VLAN membership is not set to access mode using the **switchport mode** command.

EXAMPLE

The following example sets port 1 to Voice VLAN auto mode.

```
Console(config)#interface ethernet 1/1
Console(config-if)#switchport voice vlan auto
Console(config-if)#
```

switchport voice vlan priority This command specifies a CoS priority for VoIP traffic on a port. Use the **no** form to restore the default priority on a port.

SYNTAX

switchport voice vlan priority *priority-value*

no switchport voice vlan priority

priority-value - The CoS priority value. (Range: 0-6)

DEFAULT SETTING

6

COMMAND MODE

Interface Configuration

COMMAND USAGE

Specifies a CoS priority to apply to the port VoIP traffic on the Voice VLAN. The priority of any received VoIP packet is overwritten with the new priority when the Voice VLAN feature is active for the port.

EXAMPLE

The following example sets the CoS priority to 5 on port 1.

```
Console(config)#interface ethernet 1/1
Console(config-if)#switchport voice vlan priority 5
Console(config-if)#
```

switchport voice vlan rule This command selects a method for detecting VoIP traffic on a port. Use the **no** form to disable the detection method on the port.

SYNTAX

[no] switchport voice vlan rule {oui | lldp}

oui - Traffic from VoIP devices is detected by the Organizationally Unique Identifier (OUI) of the source MAC address.

lldp - Uses LLDP to discover VoIP devices attached to the port.

DEFAULT SETTING

OUI: Enabled

LLDP: Disabled

COMMAND MODE

Interface Configuration

COMMAND USAGE

- ◆ When OUI is selected, be sure to configure the MAC address ranges in the Telephony OUI list (see the [voice vlan mac-address](#) command. MAC address OUI numbers must be configured in the Telephony OUI list so that the switch recognizes the traffic as being from a VoIP device.
- ◆ LLDP checks that the "telephone bit" in the system capability TLV is turned on. See "[LLDP Commands](#)" on page 1323 for more information on LLDP.

EXAMPLE

The following example enables the OUI method on port 1 for detecting VoIP traffic.

```
Console(config)#interface ethernet 1/1
Console(config-if)#switchport voice vlan rule oui
Console(config-if)#
```

switchport voice vlan security

This command enables security filtering for VoIP traffic on a port. Use the **no** form to disable filtering on a port.

SYNTAX

[no] switchport voice vlan security

DEFAULT SETTING

Disabled

COMMAND MODE

Interface Configuration

COMMAND USAGE

- ◆ Security filtering discards any non-VoIP packets received on the port that are tagged with the voice VLAN ID. VoIP traffic is identified by source MAC addresses configured in the Telephony OUI list, or through LLDP that discovers VoIP devices attached to the switch. Packets received from non-VoIP sources are dropped.
- ◆ When enabled, be sure the MAC address ranges for VoIP devices are configured in the Telephony OUI list ([voice vlan mac-address](#)).

EXAMPLE

The following example enables security filtering on port 1.

```
Console(config)#interface ethernet 1/1
Console(config-if)#switchport voice vlan security
Console(config-if)#
```

show voice vlan

This command displays the Voice VLAN settings on the switch and the OUI Telephony list.

SYNTAX

show voice vlan {oui | status}

oui - Displays the OUI Telephony list.

status - Displays the global and port Voice VLAN settings.

DEFAULT SETTING

None

COMMAND MODE

Privileged Exec

EXAMPLE

```

Console#show voice vlan status
Global Voice VLAN Status
Voice VLAN Status      : Enabled
Voice VLAN ID         : 1234
Voice VLAN aging time : 1440 minutes

Voice VLAN Port Summary
Port      Mode      Security Rule      Priority Remaining Age
              (minutes)
-----
Eth 1/ 1 Auto      Enabled OUI                6 100
Eth 1/ 2 Disabled Disabled OUI                6 NA
Eth 1/ 3 Manual   Enabled OUI                5 100
Eth 1/ 4 Auto      Enabled OUI                6 100
Eth 1/ 5 Disabled Disabled OUI                6 NA
Eth 1/ 6 Disabled Disabled OUI                6 NA
Eth 1/ 7 Disabled Disabled OUI                6 NA
Eth 1/ 8 Disabled Disabled OUI                6 NA
Eth 1/ 9 Disabled Disabled OUI                6 NA
Eth 1/10 Disabled Disabled OUI                6 NA

Console#show voice vlan oui
OUI Address      Mask      Description
-----
00-12-34-56-78-9A FF-FF-FF-00-00-00 old phones
00-11-22-33-44-55 FF-FF-FF-00-00-00 new phones
00-98-76-54-32-10 FF-FF-FF-FF-FF-FF Chris' phone

Console#

```

The commands described in this section allow you to specify which data packets have greater precedence when traffic is buffered in the switch due to congestion. This switch supports CoS with eight priority queues for each port. Data packets in a port's high-priority queue will be transmitted before those in the lower-priority queues. The default priority can be set for each interface, also the queue service mode and the mapping of frame priority tags to the switch's priority queues can be configured.

Table 156: Priority Commands

Command Group	Function
Priority Commands (Layer 2)	Configures the queue mode, queue weights, and default priority for untagged frames
Priority Commands (Layer 3 and 4)	Sets the default priority processing method (CoS or DSCP), maps priority tags for internal processing, maps values from internal priority table to CoS values used in tagged egress packets for Layer 2 interfaces, maps internal per hop behavior to hardware queues

PRIORITY COMMANDS (LAYER 2)

This section describes commands used to configure Layer 2 traffic priority on the switch.

Table 157: Priority Commands (Layer 2)

Command	Function	Mode
queue mode	Sets the queue mode to Weighted Round-Robin (WRR), strict priority, or a combination of strict and weighted queuing	GC
queue weight	Assigns round-robin weights to the priority queues	GC
switchport priority default	Sets a port priority for incoming untagged frames	IC
show interfaces switchport	Displays the administrative and operational status of an interface	PE
show queue mode	Shows the current queue mode	PE
show queue weight	Shows weights assigned to the weighted queues	PE

queue mode This command sets the scheduling mode used for processing each of the class of service (CoS) priority queues. The options include strict priority, Weighted Round-Robin (WRR), or a combination of strict and weighted queuing. Use the **no** form to restore the default value.

SYNTAX

queue mode {**strict** | **wrr** | **strict-wrr** [*queue-type-list*]}

no queue mode

strict - Services the egress queues in sequential order, transmitting all traffic in the higher priority queues before servicing lower priority queues. This ensures that the highest priority packets are always serviced first, ahead of all other traffic.

wrr - Weighted Round-Robin shares bandwidth at the egress ports by using scheduling weights (based on the [queue weight](#) command), and servicing each queue in a round-robin fashion.

strict-wrr - Uses strict or weighted service as specified for each queue.

queue-type-list - Indicates if the queue is a normal or strict type. (Options: 0 indicates a normal queue, 1 indicates a strict queue)

DEFAULT SETTING

WRR

COMMAND MODE

Global Configuration

COMMAND USAGE

- ◆ The switch can be set to service the port queues based on strict priority, WRR, or a combination of strict and weighted queuing.
- ◆ Strict priority requires all traffic in a higher priority queue to be processed before lower priority queues are serviced.
- ◆ Weighted Round Robin (WRR) uses a predefined relative weight for each queue that determines the percentage of service time the switch services each queue before moving on to the next queue. This prevents the head-of-line blocking that can occur with strict priority queuing. Use the [queue weight](#) command to assign weights for WRR queuing to the eight priority queues.
- ◆ If Strict and WRR mode is selected, a combination of strict and weighted service is used as specified for each queue. The queues assigned to use normal or strict priority should be specified using the *queue-type-list* parameter.
- ◆ A weight can be assigned to each of the weighted queues (and thereby to the corresponding traffic priorities). This weight sets the frequency at which each queue is polled for service, and subsequently affects the response time for software applications assigned a specific priority value.

- ◆ Service time is shared at the egress ports by defining scheduling weights for WRR, or for the queuing mode that uses a combination of strict and weighted queuing. Service time is allocated to each queue by calculating a precise number of bytes per second that will be serviced on each round.
- ◆ The specified queue mode applies to all interfaces.

EXAMPLE

The following example sets the queue mode to strict priority service mode:

```
Console(config)#queue mode strict
Console(config)#
```

RELATED COMMANDS

[queue weight \(1197\)](#)

[show queue mode \(1199\)](#)

queue weight This command assigns weights to the four class of service (CoS) priority queues when using weighted queuing, or one of the queuing modes that use a combination of strict and weighted queuing. Use the **no** form to restore the default weights.

SYNTAX

queue weight *weight0...weight3*

no queue weight

weight0...weight3 - The ratio of weights for queues 0 - 3 determines the weights used by the WRR scheduler. (Range: 1-255)

DEFAULT SETTING

Weights 1, 2, 4, 6 are assigned to queues 0 - 3 respectively.

COMMAND MODE

Global Configuration

COMMAND USAGE

- ◆ This command shares bandwidth at the egress port by defining scheduling weights for Weighted Round-Robin, or for the queuing mode that uses a combination of strict and weighted queuing ([page 1196](#)).
- ◆ Bandwidth is allocated to each queue by calculating a precise number of bytes per second that will be serviced on each round.

EXAMPLE

The following example shows how to assign round-robin weights of 1 - 4 to the CoS priority queues 0 - 3.

```
Console(config)#queue weight 1 2 3 4  
Console(config)#
```

RELATED COMMANDS

[queue mode \(1196\)](#)

[show queue weight \(1199\)](#)

switchport priority default This command sets a priority for incoming untagged frames. Use the **no** form to restore the default value.

SYNTAX

switchport priority default *default-priority-id*

no switchport priority default

default-priority-id - The priority number for untagged ingress traffic. The priority is a number from 0 to 7. Seven is the highest priority.

DEFAULT SETTING

The priority is not set, and the default value for untagged frames received on the interface is zero.

COMMAND MODE

Interface Configuration (Ethernet, Port Channel)

COMMAND USAGE

- ◆ The precedence for priority mapping is IP DSCP, and then default switchport priority.
- ◆ The default priority applies for an untagged frame received on a port set to accept all frame types (i.e, receives both untagged and tagged frames). This priority does not apply to IEEE 802.1Q VLAN tagged frames. If the incoming frame is an IEEE 802.1Q VLAN tagged frame, the IEEE 802.1p User Priority bits will be used.
- ◆ The switch provides four priority queues for each port. It can be configured to use strict priority queuing, Weighted Round Robin (WRR), or a combination of strict and weighted queuing using the [queue mode](#) command. Inbound frames that do not have VLAN tags are tagged with the input port's default ingress user priority, and then placed in the appropriate priority queue at the output port. The default priority for all ingress ports is zero. Therefore, any inbound frames that do not have priority tags will be placed in queue 1 of the output port. (Note that if the output port is an untagged member of the associated VLAN, these frames are stripped of all VLAN tags prior to transmission.)

EXAMPLE

The following example shows how to set a default priority on port 3 to 5:

```
Console(config)#interface ethernet 1/3
Console(config-if)#switchport priority default 5
Console(config-if)#
```

RELATED COMMANDS

[show interfaces switchport \(1008\)](#)

show queue mode This command shows the current queue mode.

COMMAND MODE

Privileged Exec

EXAMPLE

```
Console#show queue mode

Queue Mode : Weighted Round Robin Mode
Console#
```

show queue weight This command displays the weights used for the weighted queues.

COMMAND MODE

Privileged Exec

EXAMPLE

```
Console#show queue weight
Queue ID  Weight
-----  -
          0          1
          1          2
          2          4
          3          6
Console#
```

PRIORITY COMMANDS (LAYER 3 AND 4)

This section describes commands used to configure Layer 3 and 4 traffic priority mapping on the switch.

Table 158: Priority Commands (Layer 3 and 4)

Command	Function	Mode
<code>qos map cos-dscp</code>	Maps CoS/CFI values in incoming packets to per-hop behavior and drop precedence values for internal priority processing	GC
<code>qos map dscp-mutation</code>	Maps DSCP values in incoming packets to per-hop behavior and drop precedence values for internal priority processing	GC
<code>qos map phb-queue</code>	Maps internal per-hop behavior values to hardware queues	GC
<code>qos map trust-mode</code>	Sets QoS mapping to DSCP or CoS	IC
<code>show qos map cos-dscp</code>	Shows ingress CoS to internal DSCP map	PE
<code>show qos map dscp-mutation</code>	Shows ingress DSCP to internal DSCP map	PE
<code>show qos map phb-queue</code>	Shows internal per-hop behavior to hardware queue map	PE
<code>show qos map trust-mode</code>	Shows the QoS mapping mode	PE

* The default settings used for mapping priority values to internal DSCP values and back to the hardware queues are designed to optimize priority services for the majority of network applications. It should not be necessary to modify any of the default settings unless a queuing problem occurs with a particular application.

qos map cos-dscp This command maps CoS/CFI values in incoming packets to per-hop behavior and drop precedence values for priority processing. Use the **no** form to restore the default settings.

SYNTAX

```
qos map cos-dscp phb drop-precedence from cos0 cfi0...cos7 cfi7
no qos map cos-dscp cos0 cfi0...cos7 cfi7
```

phb - Per-hop behavior, or the priority used for this router hop.
(Range: 0-7)

drop-precedence - Drop precedence used for Random Early Detection in controlling traffic congestion. (Range: 0 - Green, 3 - Yellow, 1 - Red)

cos - CoS value in ingress packets. (Range: 0-7)

cfi - Canonical Format Indicator. Set to this parameter to "0" to indicate that the MAC address information carried in the frame is in canonical format. (Range: 0-1)

DEFAULT SETTING

Table 159: Default Mapping of CoS/CFI to Internal PHB/Drop Precedence

CoS	CFI	0	1
0		(0,0)	(0,0)
1		(1,0)	(1,0)
2		(2,0)	(2,0)
3		(3,0)	(3,0)
4		(4,0)	(4,0)
5		(5,0)	(5,0)
6		(6,0)	(6,0)
7		(7,0)	(7,0)

COMMAND MODE

Global Configuration

COMMAND USAGE

- ◆ The default mapping of CoS to PHB values shown in [Table 159](#) is based on the recommended settings in IEEE 802.1p for mapping CoS values to output queues.
- ◆ Enter a value pair for the internal per-hop behavior and drop precedence, followed by the keyword “from” and then up to eight CoS/CFI paired values separated by spaces.
- ◆ If a packet arrives with a 802.1Q header but it is not an IP packet, then the CoS/CFI-to-PHB/Drop Precedence mapping table is used to generate priority and drop precedence values for internal processing. Note that priority tags in the original packet are not modified by this command.
- ◆ The internal DSCP consists of three bits for per-hop behavior (PHB) which determines the queue to which a packet is sent; and two bits for drop precedence (namely color) which is used by Random Early Detection (RED) to control traffic congestion.
- ◆ The specified mapping applies to all interfaces.

EXAMPLE

```
Console(config)#qos map cos-dscp 0 0 from 0 1
Console(config)#
```

qos map dscp-mutation This command maps DSCP values in incoming packets to per-hop behavior and drop precedence values for priority processing. Use the **no** form to restore the default settings.

SYNTAX

qos map dscp-mutation *phb drop-precedence* **from** *dscp0 ... dscp7*

no qos map dscp-mutation *dscp0 ... dscp7*

phb - Per-hop behavior, or the priority used for this router hop.
(Range: 0-7)

drop-precedence - Drop precedence used in controlling traffic congestion.
(Range: 0 - Green, 3 - Yellow, 1 - Red)

dscp - DSCP value in ingress packets. (Range: 0-63)

DEFAULT SETTING.

Table 160: Default Mapping of DSCP Values to Internal PHB/Drop Values

	ingress-dscp1	0	1	2	3	4	5	6	7	8	9
ingress-dscp10											
0		0,0	0,1	0,0	0,3	0,0	0,1	0,0	0,3	1,0	1,1
1		1,0	1,3	1,0	1,1	1,0	1,3	2,0	2,1	2,0	2,3
2		2,0	2,1	2,0	2,3	3,0	3,1	3,0	3,3	3,0	3,1
3		3,0	3,3	4,0	4,1	4,0	4,3	4,0	4,1	4,0	4,3
4		5,0	5,1	5,0	5,3	5,0	5,1	6,0	5,3	6,0	6,1
5		6,0	6,3	6,0	6,1	6,0	6,3	7,0	7,1	7,0	7,3
6		7,0	7,1	7,0	7,3						

The ingress DSCP is composed of ingress-dscp10 (most significant digit in the left column) and ingress-dscp1 (least significant digit in the top row (in other words, ingress-dscp = ingress-dscp10 * 10 + ingress-dscp1); and the corresponding internal-dscp is shown at the intersecting cell in the table.

The ingress DSCP is bitwise ANDed with the binary value 11 to determine the drop precedence. If the resulting value is 10 binary, then the drop precedence is set to 0.

COMMAND MODE

Global Configuration

COMMAND USAGE

- ◆ Enter a value pair for the internal per-hop behavior and drop precedence, followed by the keyword "from" and then up to eight DSCP values separated by spaces.
- ◆ This map is only used when the QoS mapping mode is set to "DSCP" by the **qos map trust-mode** command, and the ingress packet type is IPv4.
- ◆ Two QoS domains can have different DSCP definitions, so the DSCP-to-PHB/Drop Precedence mutation map can be used to modify one set of DSCP values to match the definition of another domain. The mutation

map should be applied at the receiving port (ingress mutation) at the boundary of a QoS administrative domain.

- ◆ The specified mapping applies to all interfaces.

EXAMPLE

This example changes the priority for all packets entering port 1 which contain a DSCP value of 1 to a per-hop behavior of 3 and a drop precedence of 1. Referring to [Table 160](#), note that the DSCP value for these packets is now set to 25 ($3 \times 2^3 + 1$) and passed on to the egress interface.

```
Console(config)#qos map dscp-mutation 3 1 from 1
Console(config)#
```

qos map phb-queue This command determines the hardware output queues to use based on the internal per-hop behavior value. Use the **no** form to restore the default settings.

SYNTAX

qos map phb-queue *queue-id* **from** *phb0 ... phb7*

no map phb-queue *phb0 ... phb7*

phb - Per-hop behavior, or the priority used for this router hop.
(Range: 0-7)

queue-id - The ID of the priority queue. (Range: 0-7, where 7 is the highest priority queue)

DEFAULT SETTING

Table 161: Mapping Internal Per-hop Behavior to Hardware Queues

Per-hop Behavior	0	1	2	3	4	5	6	7
Hardware Queues	1	0	0	1	2	2	3	3

COMMAND MODE

Global Configuration

COMMAND USAGE

- ◆ Enter a queue identifier, followed by the keyword “from” and then up to eight internal per-hop behavior values separated by spaces.
- ◆ Egress packets are placed into the hardware queues according to the mapping defined by this command.
- ◆ The specified mapping applies to all interfaces.

EXAMPLE

```
Console(config)#qos map phb-queue 0 from 1 2 3  
Console(config)#
```

qos map trust-mode This command sets QoS mapping to DSCP or CoS. Use the **no** form to restore the default setting.

SYNTAX

qos map trust-mode {dscp | cos}

no qos map trust-mode

dscp - Sets the QoS mapping mode to DSCP.

cos - Sets the QoS mapping mode to CoS.

DEFAULT SETTING

CoS

COMMAND MODE

Interface Configuration (Port, Static Aggregation)

COMMAND USAGE

- ◆ If the QoS mapping mode is set to DSCP with this command, and the ingress packet type is IPv4, then priority processing will be based on the DSCP value in the ingress packet.
- ◆ If the QoS mapping mode is set to DSCP, and a non-IP packet is received, the packet's CoS and CFI (Canonical Format Indicator) values are used for priority processing if the packet is tagged. For an untagged packet, the default port priority (see [page 1198](#)) is used for priority processing.
- ◆ If the QoS mapping mode is set to CoS with this command, and the ingress packet type is IPv4, then priority processing will be based on the CoS and CFI values in the ingress packet.

For an untagged packet, the default port priority (see [page 1198](#)) is used for priority processing.

EXAMPLE

This example sets the QoS priority mapping mode to use DSCP based on the conditions described in the Command Usage section.

```
Console(config)#interface ge1/1  
Console(config-if)#qos map trust-mode cos  
Console(config-if)#
```

show qos map cos-dscp This command shows ingress CoS/CFI to internal DSCP map.

COMMAND MODE
Privileged Exec

EXAMPLE

```

Console#show qos map cos-dscp
CoS-DSCP map. (x,y),x: PHB,y: drop precedence:
CoS : CFI  0          1
-----
0          (0,0)      (0,0)
1          (1,0)      (1,0)
2          (2,0)      (2,0)
3          (3,0)      (3,0)
4          (4,0)      (4,0)
5          (5,0)      (5,0)
6          (6,0)      (6,0)
7          (7,0)      (7,0)
Console#

```

show qos map dscp-mutation This command shows the ingress DSCP to internal DSCP map.

SYNTAX

COMMAND MODE
Privileged Exec

COMMAND USAGE

This map is only used when the QoS mapping mode is set to "DSCP" by the `qos map trust-mode` command, and the ingress packet type is IPv4.

EXAMPLE

The ingress DSCP is composed of "d1" (most significant digit in the left column) and "d2" (least significant digit in the top row (in other words, ingress DSCP = d1 * 10 + d2)); and the corresponding Internal DSCP and drop precedence is shown at the intersecting cell in the table.

```

Console#show qos map dscp-mutation
DSCP mutation map. (x,y),x: PHB,y: drop precedence:
d1: d2 0    1    2    3    4    5    6    7    8    9
-----
0 :   (0,0) (0,1) (0,0) (0,3) (0,0) (0,1) (0,0) (0,3) (1,0) (1,1)
1 :   (1,0) (1,3) (1,0) (1,1) (1,0) (1,3) (2,0) (2,1) (2,0) (2,3)
2 :   (2,0) (2,1) (2,0) (2,3) (3,0) (3,1) (3,0) (3,3) (3,0) (3,1)
3 :   (3,0) (3,3) (4,0) (4,1) (4,0) (4,3) (4,0) (4,1) (4,0) (4,3)
4 :   (5,0) (5,1) (5,0) (5,3) (5,0) (5,1) (6,0) (5,3) (6,0) (6,1)
5 :   (6,0) (6,3) (6,0) (6,1) (6,0) (6,3) (7,0) (7,1) (7,0) (7,3)
6 :   (7,0) (7,1) (7,0) (7,3)
Console#

```

show qos map phb-queue This command shows internal per-hop behavior to hardware queue map.

COMMAND MODE
Privileged Exec

EXAMPLE

```
Console#show qos map phb-queue
PHB Queue Map:
PHB:      0      1      2      3      4      5      6      7
-----
Queue:    1      0      0      1      2      2      3      3
Console#
```

show qos map trust-mode This command shows the QoS mapping mode.

SYNTAX

show qos map trust-mode interface *interface*

interface

ethernet *unit/port*

unit - Unit identifier. (Range: 1)

port - Port number. (Range: 1-28/52)

COMMAND MODE
Privileged Exec

EXAMPLE

The following shows that the trust mode is set to CoS:

```
Console#show qos map trust-mode interface ethernet 1/5
Information of Eth 1/5
CoS Map Mode:      CoS mode
Console#
```

The commands described in this section are used to configure Differentiated Services (DiffServ) classification criteria and service policies. You can classify traffic based on access lists, IP Precedence or DSCP values, or VLANs. Using access lists allows you select traffic based on Layer 2, Layer 3, or Layer 4 information contained in each packet.

Table 162: Quality of Service Commands

Command	Function	Mode
<code>class-map</code>	Creates a class map for a type of traffic	GC
<code>description</code>	Specifies the description of a class map	CM
<code>match</code>	Defines the criteria used to classify traffic	CM
<code>rename</code>	Redefines the name of a class map	CM
<code>policy-map</code>	Creates a policy map for multiple interfaces	GC
<code>description</code>	Specifies the description of a policy map	PM
<code>class</code>	Defines a traffic classification for the policy to act on	PM
<code>rename</code>	Redefines the name of a policy map	PM
<code>police flow</code>	Defines an enforcer for classified traffic based on a metered flow rate	PM-C
<code>police srtcm-color</code>	Defines an enforcer for classified traffic based on a single rate three color meter	PM-C
<code>police trtcm-color</code>	Defines an enforcer for classified traffic based on a two rate three color meter	PM-C
<code>set cos</code>	Services IP traffic by setting a class of service value for matching packets for internal processing	PM-C
<code>set ip dscp</code>	Services IP traffic by setting an IP DSCP value for matching packets for internal processing	PM-C
<code>set phb</code>	Services IP traffic by setting a per-hop behavior value for matching packets for internal processing	PM-C
<code>service-policy</code>	Applies a policy map defined by the <code>policy-map</code> command to the input of a particular interface	IC
<code>show class-map</code>	Displays the QoS class maps which define matching criteria used for classifying traffic	PE
<code>show policy-map</code>	Displays the QoS policy maps which define classification criteria for incoming traffic, and may include policers for bandwidth limitations	PE
<code>show policy-map interface</code>	Displays the configuration of all classes configured for all service policies on the specified interface	PE

To create a service policy for a specific category of ingress traffic, follow these steps:

1. Use the `class-map` command to designate a class name for a specific category of traffic, and enter the Class Map configuration mode.
2. Use the `match` command to select a specific type of traffic based on an access list, an IPv4 DSCP value, IPv4 Precedence value, IPv6 DSCP value, a VLAN, or a CoS value.
3. Use the `policy-map` command to designate a policy name for a specific manner in which ingress traffic will be handled, and enter the Policy Map configuration mode.
4. Use the `class` command to identify the class map, and enter Policy Map Class configuration mode. A policy map can contain up to 16 class maps.
5. Use the `set phb`, `set cos` or `set ip dscp` command to modify the per-hop behavior, the class of service value in the VLAN tag, or the priority bits in the IP header (IP DSCP value) for the matching traffic class, and use one of the **police** commands to monitor parameters such as the average flow and burst rate, and drop any traffic that exceeds the specified rate, or just reduce the DSCP service level for traffic exceeding the specified rate.
6. Use the `service-policy` command to assign a policy map to a specific interface.



NOTE: Create a Class Map before creating a Policy Map.

class-map This command creates a class map used for matching packets to the specified class, and enters Class Map configuration mode. Use the **no** form to delete a class map.

SYNTAX

```
[no] class-map class-map-name [match-all | match-any]
```

class-map-name - Name of the class map. (Range: 1-32 characters)

match-all - Match all conditions within a class map.

match-any - Match any condition within a class map.

DEFAULT SETTING

None

COMMAND MODE

Global Configuration

COMMAND USAGE

- ◆ First enter this command to designate a class map and enter the Class Map configuration mode. Then use [match](#) commands to specify the criteria for ingress traffic that will be classified under this class map.
- ◆ One or more class maps can be assigned to a policy map ([page 1211](#)). The policy map is then bound by a service policy to an interface ([page 1222](#)). A service policy defines packet classification, service tagging, and bandwidth policing. Once a policy map has been bound to an interface, no additional class maps may be added to the policy map, nor any changes made to the assigned class maps with the [match](#) or **set** commands.

EXAMPLE

This example creates a class map call "rd-class," and sets it to match packets marked for DSCP service value 3:

```
Console(config)#class-map rd-class match-any
Console(config-cmap)#match ip dscp 3
Console(config-cmap)#
```

RELATED COMMANDS

[show class-map \(1223\)](#)

description This command specifies the description of a class map or policy map.

SYNTAX

description *string*

string - Description of the class map or policy map.
(Range: 1-64 characters)

COMMAND MODE

Class Map Configuration
Policy Map Configuration

EXAMPLE

```
Console(config)#class-map rd-class#1
Console(config-cmap)#description matches packets marked for DSCP service
value 3
Console(config-cmap)#
```

match This command defines the criteria used to classify traffic. Use the **no** form to delete the matching criteria.

SYNTAX

```
[no] match {access-list acl-name | cos cos | ip dscp dscp |
ip precedence ip-precedence | ipv6 dscp dscp | vlan vlan-id}
```

acl-name - Name of the access control list. Any type of ACL can be specified, including standard or extended IPv4/IPv6 ACLs and MAC ACLs. (Range: 1-16 characters)

cos - A Class of Service value. (Range: 0-7)

dscp - A Differentiated Service Code Point value. (Range: 0-63)

ip-precedence - An IP Precedence value. (Range: 0-7)

vlan-id - A VLAN. (Range:1-4094)

DEFAULT SETTING

None

COMMAND MODE

Class Map Configuration

COMMAND USAGE

- ◆ First enter the [class-map](#) command to designate a class map and enter the Class Map configuration mode. Then use **match** commands to specify the fields within ingress packets that must match to qualify for this class map.
- ◆ If an ingress packet matches an ACL specified by this command, any deny rules included in the ACL will be ignored.
- ◆ If match criteria includes an IP ACL or IP priority rule, then a VLAN rule cannot be included in the same class map.
- ◆ If match criteria includes a MAC ACL or VLAN rule, then neither an IP ACL nor IP priority rule can be included in the same class map.
- ◆ Up to 16 match entries can be included in a class map.

EXAMPLE

This example creates a class map called "rd-class#1," and sets it to match packets marked for DSCP service value 3.

```
Console(config)#class-map rd-class#1 match-any
Console(config-cmap)#match ip dscp 3
Console(config-cmap)#
```

This example creates a class map call "rd-class#2," and sets it to match packets marked for IP Precedence service value 5.

```
Console(config)#class-map rd-class#2 match-any
Console(config-cmap)#match ip precedence 5
Console(config-cmap)#
```

This example creates a class map call "rd-class#3," and sets it to match packets marked for VLAN 1.

```
Console(config)#class-map rd-class#3 match-any
Console(config-cmap)#match vlan 1
Console(config-cmap)#
```

rename This command redefines the name of a class map or policy map.

SYNTAX

rename *map-name*

map-name - Name of the class map or policy map.
(Range: 1-32 characters)

COMMAND MODE

Class Map Configuration
Policy Map Configuration

EXAMPLE

```
Console(config)#class-map rd-class#1
Console(config-cmap)#rename rd-class#9
Console(config-cmap)#
```

policy-map This command creates a policy map that can be attached to multiple interfaces, and enters Policy Map configuration mode. Use the **no** form to delete a policy map.

SYNTAX

[no] policy-map *policy-map-name*

policy-map-name - Name of the policy map.
(Range: 1-32 characters)

DEFAULT SETTING

None

COMMAND MODE

Global Configuration

COMMAND USAGE

- ◆ Use the **policy-map** command to specify the name of the policy map, and then use the **class** command to configure policies for traffic that matches the criteria defined in a class map.
- ◆ A policy map can contain multiple class statements that can be applied to the same interface with the **service-policy** command.
- ◆ Create a Class Map ([page 1211](#)) before assigning it to a Policy Map.

EXAMPLE

This example creates a policy called "rd-policy," uses the **class** command to specify the previously defined "rd-class," uses the **set** command to classify the service that incoming packets will receive, and then uses the **police flow** command to limit the average bandwidth to 100,000 Kbps, the burst rate to 4000 bytes, and configure the response to drop any violating packets.

```

Console(config)#policy-map rd-policy
Console(config-pmap)#class rd-class
Console(config-pmap-c)#set cos 3
Console(config-pmap-c)#police flow 100000 4000 conform-action transmit
violate-action drop
Console(config-pmap-c)#

```

class This command defines a traffic classification upon which a policy can act, and enters Policy Map Class configuration mode. Use the **no** form to delete a class map.

SYNTAX

[no] class *class-map-name*

class-map-name - Name of the class map. (Range: 1-32 characters)

DEFAULT SETTING

None

COMMAND MODE

Policy Map Configuration

COMMAND USAGE

- ◆ Use the **policy-map** command to specify a policy map and enter Policy Map configuration mode. Then use the **class** command to enter Policy Map Class configuration mode. And finally, use the **set** command and one of the **police** commands to specify the match criteria, where the:
 - **set phb** command sets the per-hop behavior value in matching packets. (This modifies packet priority for internal processing only.)
 - **set cos** command sets the class of service value in matching packets. (This modifies packet priority in the VLAN tag.)

- `set ip dscp` command sets the IP DSCP value in matching packets. (This modifies packet priority in the IP header.)
 - **police** commands define parameters such as the maximum throughput, burst rate, and response to non-conforming traffic.
- ◆ Up to 16 classes can be included in a policy map.

EXAMPLE

This example creates a policy called "rd-policy," uses the **class** command to specify the previously defined "rd-class," uses the `set phb` command to classify the service that incoming packets will receive, and then uses the `police flow` command to limit the average bandwidth to 100,000 Kbps, the burst rate to 4,000 bytes, and configure the response to drop any violating packets.

```

Console(config)#policy-map rd-policy
Console(config-pmap)#class rd-class
Console(config-pmap-c)#set phb 3
Console(config-pmap-c)#police flow 100000 4000 conform-action transmit
violate-action drop
Console(config-pmap-c)#

```

police flow This command defines an enforcer for classified traffic based on the metered flow rate. Use the no form to remove a policer.

SYNTAX

```

[no] police flow committed-rate committed-burst
conform-action transmit
violate-action {drop | new-dscp}

```

committed-rate - Committed information rate (CIR) in kilobits per second. (Range: 0-1000000 kbps at a granularity of 64 kbps or maximum port speed, whichever is lower)

committed-burst - Committed burst size (BC) in bytes. (Range: 0-16000000 at a granularity of 4k bytes)

conform-action - Action to take when packet is within the CIR and BC. (There are enough tokens to service the packet, the packet is set green).

violate-action - Action to take when packet exceeds the CIR and BC. (There are not enough tokens to service the packet, the packet is set red).

transmit - Transmits without taking any action.

drop - Drops packet as required by violate-action.

new-dscp - Differentiated Service Code Point (DSCP) value. (Range: 0-63)

DEFAULT SETTING

None

COMMAND MODE

Policy Map Class Configuration

COMMAND USAGE

- ◆ You can configure up to 16 policers (i.e., class maps) for ingress ports.
- ◆ The *committed-rate* cannot exceed the configured interface speed, and the *committed-burst* cannot exceed 16 Mbytes.
- ◆ Policing is based on a token bucket, where bucket depth (i.e., the maximum burst before the bucket overflows) is by specified the *committed-burst* field, and the average rate tokens are added to the bucket is by specified by the *committed-rate* option. Note that the token bucket functions similar to that described in RFC 2697 and RFC 2698.
- ◆ The behavior of the meter is specified in terms of one token bucket (C), the rate at which the tokens are incremented (CIR – Committed Information Rate), and the maximum size of the token bucket (BC – Committed Burst Size).

The token bucket C is initially full, that is, the token count $T_c(0) = BC$. Thereafter, the token count T_c is updated CIR times per second as follows:

- If T_c is less than BC, T_c is incremented by one, else
- T_c is not incremented.

When a packet of size B bytes arrives at time t, the following happens:

- If $T_c(t) - B \geq 0$, the packet is green and T_c is decremented by B down to the minimum value of 0, else
- else the packet is red and T_c is not decremented.

EXAMPLE

This example creates a policy called "rd-policy," uses the `class` command to specify the previously defined "rd-class," uses the `set phb` command to classify the service that incoming packets will receive, and then uses the **police flow** command to limit the average bandwidth to 100,000 Kbps, the burst rate to 4000 bytes, and configure the response to drop any violating packets.

```

Console(config)#policy-map rd-policy
Console(config-pmap)#class rd-class
Console(config-pmap-c)#set phb 3
Console(config-pmap-c)#police flow 100000 4000 conform-action transmit
violate-action drop
Console(config-pmap-c)#

```

police srtcm-color This command defines an enforcer for classified traffic based on a single rate three color meter (srTCM). Use the **no** form to remove a policer.

SYNTAX

```
[no] police {srtcm-color-blind | srtcm-color-aware}
    committed-rate committed-burst excess-burst
    conform-action transmit
    exceed-action {drop | new-dscp}
    violate action {drop | new-dscp}
```

srtcm-color-blind - Single rate three color meter in color-blind mode.

srtcm-color-aware - Single rate three color meter in color-aware mode.

committed-rate - Committed information rate (CIR) in kilobits per second. (Range: 0-1000000 kbps at a granularity of 64 kbps or maximum port speed, whichever is lower)

committed-burst - Committed burst size (BC) in bytes. (Range: 0-16000000 at a granularity of 4k bytes)

excess-burst - Excess burst size (BE) in bytes. (Range: 0-1600000 at a granularity of 4k bytes)

conform-action - Action to take when rate is within the CIR and BC. (There are enough tokens in bucket BC to service the packet, packet is set green).

exceed-action - Action to take when rate exceeds the CIR and BC but is within the BE. (There are enough tokens in bucket BE to service the packet, the packet is set yellow.)

violate-action - Action to take when rate exceeds the BE. (There are not enough tokens in bucket BE to service the packet, the packet is set red.)

transmit - Transmits without taking any action.

drop - Drops packet as required by exceed-action or violate-action.

new-dscp - Differentiated Service Code Point (DSCP) value. (Range: 0-63)

DEFAULT SETTING

None

COMMAND MODE

Policy Map Class Configuration

COMMAND USAGE

- ◆ You can configure up to 16 policers (i.e., class maps) for ingress ports.
- ◆ The *committed-rate* cannot exceed the configured interface speed, and the *committed-burst* and *excess-burst* cannot exceed 16 Mbytes.

- ◆ The srTCM as defined in RFC 2697 meters a traffic stream and processes its packets according to three traffic parameters – Committed Information Rate (CIR), Committed Burst Size (BC), and Excess Burst Size (BE).
- ◆ The PHB label is composed of five bits, three bits for per-hop behavior, and two bits for the color scheme used to control queue congestion. A packet is marked green if it doesn't exceed the CIR and BC, yellow if it does exceed the CIR and BC, but not the BE, and red otherwise.
- ◆ The meter operates in one of two modes. In the color-blind mode, the meter assumes that the packet stream is uncolored. In color-aware mode the meter assumes that some preceding entity has pre-colored the incoming packet stream so that each packet is either green, yellow, or red. The marker (re)colors an IP packet according to the results of the meter. The color is coded in the DS field [RFC 2474] of the packet.
- ◆ The behavior of the meter is specified in terms of its mode and two token buckets, C and E, which both share the common rate CIR. The maximum size of the token bucket C is BC and the maximum size of the token bucket E is BE.

The token buckets C and E are initially full, that is, the token count $Tc(0) = BC$ and the token count $Te(0) = BE$. Thereafter, the token counts Tc and Te are updated CIR times per second as follows:

- If Tc is less than BC, Tc is incremented by one, else
- if Te is less than BE, Te is incremented by one, else
- neither Tc nor Te is incremented.

When a packet of size B bytes arrives at time t, the following happens if srTCM is configured to operate in color-blind mode:

- If $Tc(t) - B \geq 0$, the packet is green and Tc is decremented by B down to the minimum value of 0, else
- if $Te(t) - B \geq 0$, the packets is yellow and Te is decremented by B down to the minimum value of 0,
- else the packet is red and neither Tc nor Te is decremented.

When a packet of size B bytes arrives at time t, the following happens if srTCM is configured to operate in color-aware mode:

- If the packet has been precolored as green and $Tc(t) - B \geq 0$, the packet is green and Tc is decremented by B down to the minimum value of 0, else
- If the packet has been precolored as yellow or green and if $Te(t) - B \geq 0$, the packets is yellow and Te is decremented by B down to the minimum value of 0, else the packet is red and neither Tc nor Te is decremented.

The metering policy guarantees a deterministic behavior where the volume of green packets is never smaller than what has been determined by the CIR and BC, that is, tokens of a given color are always spent on packets of that color. Refer to RFC 2697 for more information on other aspects of srTCM.

EXAMPLE

This example creates a policy called "rd-policy," uses the `class` command to specify the previously defined "rd-class," uses the `set phb` command to classify the service that incoming packets will receive, and then uses the **police srtcm-color-blind** command to limit the average bandwidth to 100,000 Kbps, the committed burst rate to 4000 bytes, the excess burst rate to 6000 bytes, to remark any packets exceeding the committed burst size, and to drop any packets exceeding the excess burst size.

```

Console(config)#policy-map rd-policy
Console(config-pmap)#class rd-class
Console(config-pmap-c)#set phb 3
Console(config-pmap-c)#police srtcm-color-blind 100000 4000 6000 conform-
  action transmit exceed-action 0 violate-action drop
Console(config-pmap-c)#

```

police trtcm-color This command defines an enforcer for classified traffic based on a two rate three color meter (trTCM). Use the **no** form to remove a policer.

SYNTAX

```

[no] police {trtcm-color-blind | trtcm-color-aware}
      committed-rate committed-burst peak-rate peak-burst
      conform-action transmit
      exceed-action {drop | new-dscp}
      violate action {drop | new-dscp}

```

trtcm-color-blind - Two rate three color meter in color-blind mode.

trtcm-color-aware - Two rate three color meter in color-aware mode.

committed-rate - Committed information rate (CIR) in kilobits per second. (Range: 64-0 kbps at a granularity of 64 kbps or maximum port speed, whichever is lower)

committed-burst - Committed burst size (BC) in bytes. (Range: 0-16000000 at a granularity of 4k bytes)

peak-rate - Peak information rate (PIR) in kilobits per second. (Range: 0-1000000 kbps at a granularity of 64 kbps or maximum port speed, whichever is lower)

peak-burst - Peak burst size (BP) in bytes. (Range: 0-16000000 at a granularity of 4k bytes)

conform-action - Action to take when rate is within the CIR and BP. (Packet size does not exceed BP and there are enough tokens in bucket BC to service the packet, the packet is set green.)

exceed-action - Action to take when rate exceeds the CIR but is within the PIR. (Packet size exceeds BC but there are enough tokens in bucket BP to service the packet, the packet is set yellow.)

violate-action - Action to take when rate exceeds the PIR. (There are not enough tokens in bucket BP to service the packet, the packet is set red.)

drop - Drops packet as required by exceed-action or violate-action.

transmit - Transmits without taking any action.

new-dscp - Differentiated Service Code Point (DSCP) value.
(Range: 0-63)

DEFAULT SETTING

None

COMMAND MODE

Policy Map Class Configuration

COMMAND USAGE

- ◆ You can configure up to 16 policers (i.e., class maps) for ingress ports.
- ◆ The *committed-rate* and *peak-rate* cannot exceed the configured interface speed, and the *committed-burst* and *peak-burst* cannot exceed 16 Mbytes.
- ◆ The trTCM as defined in RFC 2698 meters a traffic stream and processes its packets based on two rates – Committed Information Rate (CIR) and Peak Information Rate (PIR), and their associated burst sizes - Committed Burst Size (BC) and Peak Burst Size (BP).
- ◆ The PHB label is composed of five bits, three bits for per-hop behavior, and two bits for the color scheme used to control queue congestion. A packet is marked red if it exceeds the PIR. Otherwise it is marked either yellow or green depending on whether it exceeds or doesn't exceed the CIR.

The trTCM is useful for ingress policing of a service, where a peak rate needs to be enforced separately from a committed rate.

- ◆ The meter operates in one of two modes. In the color-blind mode, the meter assumes that the packet stream is uncolored. In color-aware mode the meter assumes that some preceding entity has pre-colored the incoming packet stream so that each packet is either green, yellow, or red. The marker (re)colors an IP packet according to the results of the meter. The color is coded in the DS field [RFC 2474] of the packet.
- ◆ The behavior of the meter is specified in terms of its mode and two token buckets, P and C, which are based on the rates PIR and CIR, respectively. The maximum size of the token bucket P is BP and the maximum size of the token bucket C is BC.
- ◆ The token buckets P and C are initially (at time 0) full, that is, the token count $T_p(0) = BP$ and the token count $T_c(0) = BC$. Thereafter, the token count T_p is incremented by one PIR times per second up to BP and the token count T_c is incremented by one CIR times per second up to BC.

When a packet of size B bytes arrives at time t, the following happens if trTCM is configured to operate in color-blind mode:

- If $T_p(t) - B < 0$, the packet is red, else
- if $T_c(t) - B < 0$, the packet is yellow and T_p is decremented by B, else
- the packet is green and both T_p and T_c are decremented by B.

When a packet of size B bytes arrives at time t, the following happens if trTCM is configured to operate in color-aware mode:

- If the packet has been precolored as red or if $T_p(t) - B < 0$, the packet is red, else
 - if the packet has been precolored as yellow or if $T_c(t) - B < 0$, the packet is yellow and T_p is decremented by B, else
 - the packet is green and both T_p and T_c are decremented by B.
- ◆ The trTCM can be used to mark a IP packet stream in a service, where different, decreasing levels of assurances (either absolute or relative) are given to packets which are green, yellow, or red. Refer to RFC 2698 for more information on other aspects of trTCM.

EXAMPLE

This example creates a policy called "rd-policy," uses the `class` command to specify the previously defined "rd-class," uses the `set phb` command to classify the service that incoming packets will receive, and then uses the **police trtcm-color-blind** command to limit the average bandwidth to 100,000 Kbps, the committed burst rate to 4000 bytes, the peak information rate to 1,000,000 kbps, the peak burst size to 6000, to remark any packets exceeding the committed burst size, and to drop any packets exceeding the peak information rate.

```
Console(config)#policy-map rd-policy
Console(config-pmap)#class rd-class
Console(config-pmap-c)#set phb 3
Console(config-pmap-c)#police trtcm-color-blind 100000 4000 1000000 6000
    conform-action transmit exceed-action 0 violate-action drop
Console(config-pmap-c)#
```

set cos This command modifies the class of service (CoS) value for a matching packet (as specified by the `match` command) in the packet's VLAN tag. Use the **no** form to remove this setting.

SYNTAX

[no] set cos *cos-value*

cos-value - Class of Service value. (Range: 0-7)

DEFAULT SETTING

None

COMMAND MODE

Policy Map Class Configuration

COMMAND USAGE

- ◆ The **set cos** command is used to set the CoS value in the VLAN tag for matching packets.
- ◆ The **set cos** and **set phb** command function at the same level of priority. Therefore setting either of these commands will overwrite any action already configured by the other command.

EXAMPLE

This example creates a policy called "rd-policy," uses the **class** command to specify the previously defined "rd-class," uses the **set cos** command to classify the service that incoming packets will receive, and then uses the **police flow** command to limit the average bandwidth to 100,000 Kbps, the burst rate to 4000 bytes, and configure the response to drop any violating packets.

```

Console(config)#policy-map rd-policy
Console(config-pmap)#class rd-class
Console(config-pmap-c)#set cos 3
Console(config-pmap-c)#police flow 100000 4000 conform-action transmit
violate-action drop
Console(config-pmap-c)#

```

set ip dscp This command modifies the IP DSCP value in a matching packet (as specified by the **match** command). Use the **no** form to remove this traffic classification.

SYNTAX

[no] set ip dscp new-dscp

new-dscp - New Differentiated Service Code Point (DSCP) value.
(Range: 0-63)

DEFAULT SETTING

None

COMMAND MODE

Policy Map Class Configuration

COMMAND USAGE

The **set ip dscp** command is used to set the priority values in the packet's ToS field for matching packets.

EXAMPLE

This example creates a policy called "rd-policy," uses the [class](#) command to specify the previously defined "rd-class," uses the **set ip dscp** command to classify the service that incoming packets will receive, and then uses the [police flow](#) command to limit the average bandwidth to 100,000 Kbps, the burst rate to 4000 bytes, and configure the response to drop any violating packets.

```

Console(config)#policy-map rd-policy
Console(config-pmap)#class rd-class
Console(config-pmap-c)#set ip dscp 3
Console(config-pmap-c)#police flow 100000 4000 conform-action transmit
violate-action drop
Console(config-pmap-c)#

```

set phb This command services IP traffic by setting a per-hop behavior value for a matching packet (as specified by the [match](#) command) for internal processing. Use the **no** form to remove this setting.

SYNTAX

[no] set phb *phb-value*

phb-value - Per-hop behavior value. (Range: 0-7)

DEFAULT SETTING

None

COMMAND MODE

Policy Map Class Configuration

COMMAND USAGE

- ◆ The **set phb** command is used to set an internal QoS value in hardware for matching packets (see [Table 160, "Default Mapping of DSCP Values to Internal PHB/Drop Values"](#)). The QoS label is composed of five bits, three bits for per-hop behavior, and two bits for the color scheme used to control queue congestion by the [police srtcm-color](#) command and [police trtcm-color](#) command.
- ◆ The [set cos](#) and **set phb** command function at the same level of priority. Therefore setting either of these commands will overwrite any action already configured by the other command.

EXAMPLE

This example creates a policy called "rd-policy," uses the `class` command to specify the previously defined "rd-class," uses the `set phb` command to classify the service that incoming packets will receive, and then uses the `police flow` command to limit the average bandwidth to 100,000 Kbps, the burst rate to 4000 bytes, and configure the response to drop any violating packets.

```

Console(config)#policy-map rd-policy
Console(config-pmap)#class rd-class
Console(config-pmap-c)#set phb 3
Console(config-pmap-c)#police flow 100000 4000 conform-action transmit
violate-action drop
Console(config-pmap-c)#

```

service-policy This command applies a policy map defined by the `policy-map` command to the ingress side of a particular interface. Use the `no` form to remove this mapping.

SYNTAX

[no] service-policy input *policy-map-name*

input - Apply to the input traffic.

policy-map-name - Name of the policy map for this interface.
(Range: 1-32 characters)

DEFAULT SETTING

No policy map is attached to an interface.

COMMAND MODE

Interface Configuration (Ethernet)

COMMAND USAGE

- ◆ Only one policy map can be assigned to an interface.
- ◆ First define a class map, then define a policy map, and finally use the **service-policy** command to bind the policy map to the required interface.
- ◆ The switch does not allow a policy map to be bound to an interface for egress traffic.

EXAMPLE

This example applies a service policy to an ingress interface.

```

Console(config)#interface ethernet 1/1
Console(config-if)#service-policy input rd-policy
Console(config-if)#

```

show class-map This command displays the QoS class maps which define matching criteria used for classifying traffic.

SYNTAX

show class-map [*class-map-name*]

class-map-name - Name of the class map. (Range: 1-32 characters)

DEFAULT SETTING

Displays all class maps.

COMMAND MODE

Privileged Exec

EXAMPLE

```

Console#show class-map
Class Map match-any rd-class#1
Description:
  Match ip dscp 10
  Match access-list rd-access
  Match ip dscp 0

Class Map match-any rd-class#2
  Match ip precedence 5

Class Map match-any rd-class#3
  Match vlan 1

Console#

```

show policy-map This command displays the QoS policy maps which define classification criteria for incoming traffic, and may include policers for bandwidth limitations.

SYNTAX

show policy-map [*policy-map-name* [**class** *class-map-name*]]

policy-map-name - Name of the policy map.
(Range: 1-32 characters)

class-map-name - Name of the class map. (Range: 1-32 characters)

DEFAULT SETTING

Displays all policy maps and all classes.

COMMAND MODE

Privileged Exec

EXAMPLE

```

Console#show policy-map
Policy Map rd-policy
Description:
  class rd-class
  set PHB 3
Console#show policy-map rd-policy class rd-class
Policy Map rd-policy
  class rd-class
  set PHB 3
Console#

```

show policy-map interface This command displays the service policy assigned to the specified interface.

SYNTAX

show policy-map interface *interface input*

interface

unit/port

unit - Unit identifier. (Range: 1)

port - Port number. (Range: 1-28/52)

COMMAND MODE

Privileged Exec

EXAMPLE

```

Console#show policy-map interface 1/5 input
Service-policy rd-policy
Console#

```

This switch uses IGMP (Internet Group Management Protocol) to check for any attached hosts that want to receive a specific multicast service. It identifies the ports containing hosts requesting a service and sends data out to those ports only. It then propagates the service request up to any neighboring multicast switch/router to ensure that it will continue to receive the multicast service.

Table 163: Multicast Filtering Commands

Command Group	Function
IGMP Snooping	Configures multicast groups via IGMP snooping or static assignment, sets the IGMP version, enables proxy reporting, displays current snooping settings, and displays the multicast service and group members
Static Multicast Routing	Configures static multicast router ports which forward all inbound multicast traffic to the attached VLANs
IGMP Filtering and Throttling	Configures IGMP filtering and throttling
MLD Snooping	Configures Multicast Listener Discovery snooping for IPv6
MLD Filtering and Throttling	Configures MLD filtering and throttling for IPv6.
MVR for IPv4	Configures a single network-wide multicast VLAN shared by hosts residing in other standard or private VLAN groups, preserving security and data isolation for normal traffic
MVR for IPv6	Configures a single network-wide multicast VLAN shared by hosts residing in other standard or private VLAN groups, preserving security and data isolation for normal traffic

IGMP SNOOPING

This section describes commands used to configure IGMP snooping on the switch.

Table 164: IGMP Snooping Commands

Command	Function	Mode
<code>ip igmp snooping</code>	Enables IGMP snooping	GC
<code>ip igmp snooping priority</code>	Assigns a priority to all multicast traffic	GC
<code>ip igmp snooping proxy-reporting</code>	Enables IGMP Snooping with Proxy Reporting	GC
<code>ip igmp snooping querier</code>	Allows this device to act as the querier for IGMP snooping	GC
<code>ip igmp snooping router-alert-option-check</code>	Discards any IGMPv2/v3 packets that do not include the Router Alert option	GC
<code>ip igmp snooping router-port-expire-time</code>	Configures the querier timeout	GC
<code>ip igmp snooping tcn-flood</code>	Floods multicast traffic when a Spanning Tree topology change occurs	GC
<code>ip igmp snooping tcn-query-solicit</code>	Sends an IGMP Query Solicitation when a Spanning Tree topology change occurs	GC
<code>ip igmp snooping unregistered-data-flood</code>	Floods unregistered multicast traffic into the attached VLAN	GC
<code>ip igmp snooping unsolicited-report-interval</code>	Specifies how often the upstream interface should transmit unsolicited IGMP reports (when proxy reporting is enabled)	GC
<code>ip igmp snooping version</code>	Configures the IGMP version for snooping	GC
<code>ip igmp snooping version-exclusive</code>	Discards received IGMP messages which use a version different to that currently configured	GC
<code>ip igmp snooping vlan general-query-suppression</code>	Suppresses general queries except for ports attached to downstream multicast hosts	GC
<code>ip igmp snooping vlan immediate-leave</code>	Immediately deletes a member port of a multicast service if a leave packet is received at that port and immediate-leave is enabled for the parent VLAN	GC
<code>ip igmp snooping vlan last-memb-query-count</code>	Configures the number of IGMP proxy query messages that are sent out before the system assumes there are no local members	GC
<code>ip igmp snooping vlan last-memb-query-intvl</code>	Configures the last-member-query interval	GC
<code>ip igmp snooping vlan mrd</code>	Sends multicast router solicitation messages	GC
<code>ip igmp snooping vlan proxy-address</code>	Configures a static address for proxy IGMP query and reporting	GC
<code>ip igmp snooping vlan proxy-reporting</code>	Enables IGMP Snooping with Proxy Reporting	GC
<code>ip igmp snooping vlan query-interval</code>	Configures the interval between sending IGMP general queries	GC
<code>ip igmp snooping vlan query-resp-intvl</code>	Configures the maximum time the system waits for a response to general queries	GC

Table 164: IGMP Snooping Commands (Continued)

Command	Function	Mode
<code>ip igmp snooping vlan static</code>	Adds an interface as a member of a multicast group	GC
<code>ip igmp snooping vlan version</code>	Configures the IGMP version for snooping	GC
<code>ip igmp snooping vlan version-exclusive</code>	Discards received IGMP messages which use a version different to that currently configured	GC
<code>clear ip igmp snooping groups dynamic</code>	Clears multicast group information dynamically learned through IGMP snooping	PE
<code>clear ip igmp snooping statistics</code>	Clears IGMP snooping statistics	PE
<code>show ip igmp snooping</code>	Shows the IGMP snooping, proxy, and query configuration	PE
<code>show ip igmp snooping group</code>	Shows known multicast group, source, and host port mapping	PE
<code>show ip igmp snooping mrouter</code>	Shows multicast router ports	PE
<code>show ip igmp snooping statistics</code>	Shows IGMP snooping protocol statistics for the specified interface	PE

ip igmp snooping This command enables IGMP snooping globally on the switch or on a selected VLAN interface. Use the **no** form to disable it.

SYNTAX

```
[no] ip igmp snooping [vlan vlan-id]
```

vlan-id - VLAN ID (Range: 1-4094)

DEFAULT SETTING

Enabled

COMMAND MODE

Global Configuration

COMMAND USAGE

- ◆ When IGMP snooping is enabled globally, the per VLAN interface settings for IGMP snooping take precedence.
- ◆ When IGMP snooping is disabled globally, snooping can still be configured per VLAN interface, but the interface settings will not take effect until snooping is re-enabled globally.

EXAMPLE

The following example enables IGMP snooping globally.

```
Console(config)#ip igmp snooping
Console(config)#
```

ip igmp snooping priority This command assigns a priority to all multicast traffic. Use the **no** form to restore the default setting.

SYNTAX

ip igmp snooping priority *priority*

no ip igmp snooping priority

priority - The CoS priority assigned to all multicast traffic.
(Range: 0-7, where 7 is the highest priority)

DEFAULT SETTING

2

COMMAND MODE

Global Configuration

COMMAND USAGE

This command can be used to set a high priority for low-latency multicast traffic such as a video-conference, or to set a low priority for normal multicast traffic not sensitive to latency.

EXAMPLE

```
Console(config)#ip igmp snooping priority 6
Console(config)#
```

RELATED COMMANDS

[show ip igmp snooping \(1243\)](#)

ip igmp snooping proxy-reporting This command enables IGMP Snooping with Proxy Reporting. Use the **no** form to restore the default setting.

SYNTAX

[no] ip igmp snooping proxy-reporting

ip igmp snooping vlan *vlan-id* **proxy-reporting** {**enable** | **disable**}

no ip igmp snooping vlan *vlan-id* **proxy-reporting**

vlan-id - VLAN ID (Range: 1-4094)

enable - Enable on the specified VLAN.

disable - Disable on the specified VLAN.

DEFAULT SETTING

Global: Disabled

VLAN: Based on global setting

COMMAND MODE

Global Configuration

COMMAND USAGE

- ◆ When proxy reporting is enabled with this command, the switch performs “IGMP Snooping with Proxy Reporting” (as defined in DSL Forum TR-101, April 2006), including last leave, and query suppression. Last leave sends out a proxy query when the last member leaves a multicast group, and query suppression means that specific queries are not forwarded from an upstream multicast router to hosts downstream from this device.
- ◆ If the IGMP proxy reporting is configured on a VLAN, this setting takes precedence over the global configuration.

EXAMPLE

```
Console(config)#ip igmp snooping proxy-reporting
Console(config)#
```

ip igmp snooping querier

This command enables the switch as an IGMP querier. Use the **no** form to disable it.

SYNTAX

[no] ip igmp snooping querier

DEFAULT SETTING

Disabled

COMMAND MODE

Global Configuration

COMMAND USAGE

If enabled, the switch will serve as querier if elected. The querier is responsible for asking hosts if they want to receive multicast traffic.

EXAMPLE

```
Console(config)#ip igmp snooping querier
Console(config)#
```

ip igmp snooping router-alert-option-check

This command discards any IGMPv2/v3 packets that do not include the Router Alert option. Use the **no** form to ignore the Router Alert Option when receiving IGMP messages.

SYNTAX

[no] ip igmp snooping router-alert-option-check

DEFAULT SETTING

Disabled

COMMAND MODE

Global Configuration

COMMAND USAGE

As described in Section 9.1 of RFC 3376 for IGMP Version 3, the Router Alert Option can be used to protect against DOS attacks. One common method of attack is launched by an intruder who takes over the role of querier, and starts overloading multicast hosts by sending a large number of group-and-source-specific queries, each with a large source list and the Maximum Response Time set to a large value.

To protect against this kind of attack, (1) routers should not forward queries. This is easier to accomplish if the query carries the Router Alert option. (2) Also, when the switch is acting in the role of a multicast host (such as when using proxy routing), it should ignore version 2 or 3 queries that do not contain the Router Alert option.

EXAMPLE

```
Console(config)#ip igmp snooping router-alert-option-check
Console(config)#
```

ip igmp snooping router-port- expire-time

This command configures the querier time out. Use the **no** form to restore the default.

SYNTAX

ip igmp snooping router-port-expire-time *seconds*

no ip igmp snooping router-port-expire-time

seconds - The time the switch waits after the previous querier stops before it considers it to have expired. (Range: 1-65535; Recommended Range: 300-500)

DEFAULT SETTING

300 seconds

COMMAND MODE

Global Configuration

EXAMPLE

The following shows how to configure the time out to 400 seconds:

```
Console(config)#ip igmp snooping router-port-expire-time 400
Console(config)#
```

ip igmp snooping tcn-flood This command enables flooding of multicast traffic if a spanning tree topology change notification (TCN) occurs. Use the **no** form to disable flooding.

SYNTAX

[no] ip igmp snooping tcn-flood

DEFAULT SETTING

Disabled

COMMAND MODE

Global Configuration

COMMAND USAGE

- ◆ When a spanning tree topology change occurs, the multicast membership information learned by the switch may be out of date. For example, a host linked to one port before the topology change (TC) may be moved to another port after the change. To ensure that multicast data is delivered to all receivers, by default, a switch in a VLAN (with IGMP snooping enabled) that receives a Bridge Protocol Data Unit (BPDU) with the TC bit set (by the root bridge) will enter into "multicast flooding mode" for a period of time until the topology has stabilized and the new locations of all multicast receivers are learned.
- ◆ If a topology change notification (TCN) is received, and all the uplink ports are subsequently deleted, a time out mechanism is used to delete all of the currently learned multicast channels.
- ◆ When a new uplink port starts up, the switch sends unsolicited reports for all current learned channels out through the new uplink port.
- ◆ By default, the switch immediately enters into "multicast flooding mode" when a spanning tree topology change occurs. In this mode, multicast traffic will be flooded to all VLAN ports. If many ports have subscribed to different multicast groups, flooding may cause excessive loading on the link between the switch and the end host. Flooding may be disabled to avoid this, causing multicast traffic to be delivered only to those ports on which multicast group members have been learned.
- ◆ When the spanning tree topology changes, the root bridge sends a proxy query to quickly re-learn the host membership/port relations for multicast channels. The root bridge also sends an unsolicited Multicast Router Discover (MRD) request to quickly locate the multicast routers in this VLAN.

The proxy query and unsolicited MRD request are flooded to all VLAN ports except for the receiving port when the switch receives such packets.

EXAMPLE

The following example enables TCN flooding.

```
Console(config)#ip igmp snooping tcn-flood  
Console(config)#
```

ip igmp snooping tcn-query-solicit

This command instructs the switch to send out an IGMP general query solicitation when a spanning tree topology change notification (TCN) occurs. Use the **no** form to disable this feature.

SYNTAX

[no] ip igmp snooping tcn-query-solicit

DEFAULT SETTING

Disabled

COMMAND MODE

Global Configuration

COMMAND USAGE

- ◆ When the root bridge in a spanning tree receives a topology change notification for a VLAN where IGMP snooping is enabled, it issues a global IGMP leave message (query solicitation). When a switch receives this solicitation, it floods it to all ports in the VLAN where the spanning tree change occurred. When an upstream multicast router receives this solicitation, it will also immediately issues an IGMP general query.
- ◆ The **ip igmp snooping tcn query-solicit** command can be used to send a query solicitation whenever it notices a topology change, even if the switch is not the root bridge in the spanning tree.

EXAMPLE

The following example instructs the switch to issue an IGMP general query whenever it receives a spanning tree topology change notification.

```
Console(config)#ip igmp snooping tcn query-solicit  
Console(config)#
```

ip igmp snooping unregistered- data-flood

This command floods unregistered multicast traffic into the attached VLAN. Use the **no** form to drop unregistered multicast traffic.

SYNTAX

[no] ip igmp snooping unregistered-data-flood

DEFAULT SETTING

Disabled

COMMAND MODE

Global Configuration

COMMAND USAGE

Once the table used to store multicast entries for IGMP snooping and multicast routing is filled, no new entries are learned. If no router port is configured in the attached VLAN, and unregistered-flooding is disabled, any subsequent multicast traffic not found in the table is dropped, otherwise it is flooded throughout the VLAN.

EXAMPLE

```
Console(config)#ip igmp snooping unregistered-data-flood
Console(config)#
```

**ip igmp snooping
unsolicited-report-
interval**

This command specifies how often the upstream interface should transmit unsolicited IGMP reports when proxy reporting is enabled. Use the **no** form to restore the default value.

SYNTAX

ip igmp snooping unsolicited-report-interval *seconds*

no ip igmp snooping version-exclusive

seconds - The interval at which to issue unsolicited reports.
(Range: 1-65535 seconds)

DEFAULT SETTING

400 seconds

COMMAND MODE

Global Configuration

COMMAND USAGE

- ◆ When a new upstream interface (that is, uplink port) starts up, the switch sends unsolicited reports for all currently learned multicast channels out through the new upstream interface.
- ◆ This command only applies when proxy reporting is enabled (see [page 1228](#)).

EXAMPLE

```
Console(config)#ip igmp snooping unsolicited-report-interval 5
Console(config)#
```

ip igmp snooping version This command configures the IGMP snooping version. Use the **no** form to restore the default.

SYNTAX

ip igmp snooping [vlan *vlan-id*] version {1 | 2 | 3}

no ip igmp snooping version

vlan-id - VLAN ID (Range: 1-4094)

1 - IGMP Version 1

2 - IGMP Version 2

3 - IGMP Version 3

DEFAULT SETTING

Global: IGMP Version 2

VLAN: Not configured, based on global setting

COMMAND MODE

Global Configuration

COMMAND USAGE

- ◆ This command configures the IGMP report/query version used by IGMP snooping. Versions 1 - 3 are all supported, and versions 2 and 3 are backward compatible, so the switch can operate with other devices, regardless of the snooping version employed.
- ◆ If the IGMP snooping version is configured on a VLAN, this setting takes precedence over the global configuration.

EXAMPLE

The following configures the global setting for IGMP snooping to version 1.

```
Console(config)#ip igmp snooping version 1
Console(config)#
```

ip igmp snooping version-exclusive This command discards any received IGMP messages (except for multicast protocol packets) which use a version different to that currently configured by the **ip igmp snooping version** command. Use the **no** form to disable this feature.

SYNTAX

ip igmp snooping [vlan *vlan-id*] version-exclusive

no ip igmp snooping version-exclusive

vlan-id - VLAN ID (Range: 1-4094)

DEFAULT SETTING

Global: Disabled
VLAN: Disabled

COMMAND MODE

Global Configuration

COMMAND USAGE

- ◆ If version exclusive is disabled on a VLAN, then this setting is based on the global setting. If it is enabled on a VLAN, then this setting takes precedence over the global setting.
- ◆ When this function is disabled, the currently selected version is backward compatible (see the [ip igmp snooping version](#) command).

EXAMPLE

```
Console(config)#ip igmp snooping version-exclusive  
Console(config)#
```

**ip igmp snooping
vlan general-query-
suppression**

This command suppresses general queries except for ports attached to downstream multicast hosts. Use the **no** form to flood general queries to all ports except for the multicast router port.

SYNTAX

[no] ip igmp snooping vlan *vlan-id* general-query-suppression

vlan-id - VLAN ID (Range: 1-4094)

DEFAULT SETTING

Disabled

COMMAND MODE

Global Configuration

COMMAND USAGE

- ◆ By default, general query messages are flooded to all ports, except for the multicast router through which they are received.
- ◆ If general query suppression is enabled, then these messages are forwarded only to downstream ports which have joined a multicast service.

EXAMPLE

```
Console(config)#ip igmp snooping vlan 1 general-query-suppression  
Console(config)#
```

ip igmp snooping vlan immediate-leave

This command immediately deletes a member port of a multicast service if a leave packet is received at that port and immediate-leave is enabled for the parent VLAN. Use the **no** form to restore the default.

SYNTAX

[no] ip igmp snooping vlan *vlan-id* immediate-leave

vlan-id - VLAN ID (Range: 1-4094)

DEFAULT SETTING

Disabled

COMMAND MODE

Global Configuration

COMMAND USAGE

- ◆ If immediate-leave is *not* used, a multicast router (or querier) will send a group-specific query message when an IGMPv2/v3 group leave message is received. The router/querier stops forwarding traffic for that group only if no host replies to the query within the time out period. (The time out for this release is currently defined by Last Member Query Interval (fixed at one second) * Robustness Variable (fixed at 2) as defined in RFC 2236.
- ◆ If immediate-leave is enabled, the switch assumes that only one host is connected to the interface. Therefore, immediate leave should only be enabled on an interface if it is connected to only one IGMP-enabled device, either a service host or a neighbor running IGMP snooping.
- ◆ This command is only effective if IGMP snooping is enabled, and IGMPv2 or IGMPv3 snooping is used.

EXAMPLE

The following shows how to enable immediate leave.

```
Console(config)#ip igmp snooping vlan 1 immediate-leave  
Console(config)#
```

ip igmp snooping vlan last-memb-query-count This command configures the number of IGMP proxy group-specific or group-and-source-specific query messages that are sent out before the system assumes there are no more local members. Use the **no** form to restore the default.

SYNTAX

ip igmp snooping vlan *vlan-id* last-memb-query-count *count*

no ip igmp snooping vlan *vlan-id* last-memb-query-count

vlan-id - VLAN ID (Range: 1-4094)

count - The number of proxy group-specific or group-and-source-specific query messages to issue before assuming that there are no more group members. (Range: 1-255)

DEFAULT SETTING

2

COMMAND MODE

Global Configuration

COMMAND USAGE

This command will take effect only if IGMP snooping proxy reporting or IGMP querier is enabled ([page 1228](#)).

EXAMPLE

```
Console(config)#ip igmp snooping vlan 1 last-memb-query-count 7
Console(config)#
```

ip igmp snooping vlan last-memb-query-intvl This command configures the last-member-query interval. Use the **no** form to restore the default.

SYNTAX

ip igmp snooping vlan *vlan-id* last-memb-query-intvl *interval*

no ip igmp snooping vlan *vlan-id* last-memb-query-intvl

vlan-id - VLAN ID (Range: 1-4094)

interval - The interval to wait for a response to a group-specific or group-and-source-specific query message. (Range: 1-31744 tenths of a second)

DEFAULT SETTING

10 (1 second)

COMMAND MODE

Global Configuration

COMMAND USAGE

- ◆ When a multicast host leaves a group, it sends an IGMP leave message. When the leave message is received by the switch, it checks to see if this host is the last to leave the group by sending out an IGMP group-specific or group-and-source-specific query message, and starts a timer. If no reports are received before the timer expires, the group record is deleted, and a report is sent to the upstream multicast router.
- ◆ A reduced value will result in reduced time to detect the loss of the last member of a group or source, but may generate more bursty traffic.
- ◆ This command will take effect only if IGMP snooping proxy reporting is enabled (page 1228).

EXAMPLE

```
Console(config)#ip igmp snooping vlan 1 last-memb-query-intvl 700
Console(config)#
```

ip igmp snooping vlan mrd

This command enables sending of multicast router solicitation messages. Use the **no** form to disable these messages.

SYNTAX

[no] ip igmp snooping vlan *vlan-id* mrd

vlan-id - VLAN ID (Range: 1-4094)

DEFAULT SETTING

Disabled

COMMAND MODE

Global Configuration

COMMAND USAGE

- ◆ Multicast Router Discovery (MRD) uses multicast router advertisement, multicast router solicitation, and multicast router termination messages to discover multicast routers. Devices send solicitation messages in order to solicit advertisement messages from multicast routers. These messages are used to discover multicast routers on a directly attached link. Solicitation messages are also sent whenever a multicast forwarding interface is initialized or re-initialized. Upon receiving a solicitation on an interface with IP multicast forwarding and MRD enabled, a router will respond with an advertisement.
- ◆ Advertisements are sent by routers to advertise that IP multicast forwarding is enabled. These messages are sent unsolicited periodically on all router interfaces on which multicast forwarding is enabled. They are sent upon the expiration of a periodic timer, as a part of a router's start up procedure, during the restart of a multicast forwarding interface, and on receipt of a solicitation message. When the multicast services provided to a VLAN is relatively stable, the use of solicitation

messages is not required and may be disabled using the **no ip igmp snooping vlan mrd** command.

- ◆ This command may also be used to disable multicast router solicitation messages when the upstream router does not support MRD, to reduce the loading on a busy upstream router, or when IGMP snooping is disabled in a VLAN.

EXAMPLE

This example disables sending of multicast router solicitation messages on VLAN 1.

```
Console(config)#no ip igmp snooping vlan 1 mrd
Console(config)#
```

ip igmp snooping vlan proxy-address

This command configures a static source address for locally generated query and report messages used by IGMP proxy reporting. Use the **no** form to restore the default source address.

SYNTAX

[no] ip igmp snooping vlan *vlan-id* proxy-address source-address

vlan-id - VLAN ID (Range: 1-4094)

source-address - The source address used for proxied IGMP query and report, and leave messages. (Any valid IP unicast address)

DEFAULT SETTING

0.0.0.0

COMMAND MODE

Global Configuration

COMMAND USAGE

IGMP Snooping uses a null IP address of 0.0.0.0 for the source of IGMP query messages which are proxied to downstream hosts to indicate that it is not the elected querier, but is only proxying these messages as defined in RFC 4541. The switch also uses a null address in IGMP reports sent to upstream ports.

Many hosts do not implement RFC 4541, and therefore do not understand query messages with the source address of 0.0.0.0. These hosts will therefore not reply to the queries, causing the multicast router to stop sending traffic to them.

To resolve this problem, the source address in proxied IGMP query and report messages can be replaced with any valid unicast address (other than the router's own address) using this command.

Rules Used for Proxy Reporting

When IGMP Proxy Reporting is disabled, the switch will use a null IP address for the source of IGMP query and report messages unless a proxy query address has been set.

When IGMP Proxy Reporting is enabled, the source address is based on the following criteria:

- ◆ If a proxy query address is configured, the switch will use that address as the source IP address in general and group-specific query messages sent to downstream hosts, and in report and leave messages sent upstream from the multicast router port.
- ◆ If a proxy query address is not configured, the switch will use the VLAN's IP address as the IP source address in general and group-specific query messages sent downstream, and use the source address of the last IGMP message received from a downstream host in report and leave messages sent upstream from the multicast router port.

EXAMPLE

The following example sets the source address for proxied IGMP query messages to 10.0.1.8.

```
Console(config)#ip igmp snooping vlan 1 proxy-address 10.0.1.8  
Console(config)#
```

ip igmp snooping vlan query-interval

This command configures the interval between sending IGMP general queries. Use the **no** form to restore the default.

SYNTAX

ip igmp snooping vlan *vlan-id* **query-interval** *interval*

no ip igmp snooping vlan *vlan-id* **query-interval**

vlan-id - VLAN ID (Range: 1-4094)

interval - The interval between sending IGMP general queries.
(Range: 2-31744 seconds)

DEFAULT SETTING

125 seconds

COMMAND MODE

Global Configuration

COMMAND USAGE

- ◆ An IGMP general query message is sent by the switch at the interval specified by this command. When this message is received by downstream hosts, all receivers build an IGMP report for the multicast groups they have joined.

- ◆ This command applies when the switch is serving as the querier ([page 1229](#)), or as a proxy host when IGMP snooping proxy reporting is enabled ([page 1228](#)).

EXAMPLE

```
Console(config)#ip igmp snooping vlan 1 query-interval 150
Console(config)#
```

ip igmp snooping vlan query-resp-intvl

This command configures the maximum time the system waits for a response to general queries. Use the **no** form to restore the default.

SYNTAX

ip igmp snooping vlan *vlan-id* **query-resp-intvl** *interval*

no ip igmp snooping vlan *vlan-id* **query-resp-intvl**

vlan-id - VLAN ID (Range: 1-4094)

interval - The maximum time the system waits for a response to general queries. (Range: 10-31740 tenths of a second)

DEFAULT SETTING

100 (10 seconds)

COMMAND MODE

Global Configuration

COMMAND USAGE

This command applies when the switch is serving as the querier ([page 1229](#)), or as a proxy host when IGMP snooping proxy reporting is enabled ([page 1228](#)).

EXAMPLE

```
Console(config)#ip igmp snooping vlan 1 query-resp-intvl 20
Console(config)#
```

**ip igmp snooping
vlan static** This command adds a port to a multicast group. Use the **no** form to remove the port.

SYNTAX

[no] ip igmp snooping vlan *vlan-id* static *ip-address* *interface*

vlan-id - VLAN ID (Range: 1-4094)

ip-address - IP address for multicast group

interface

ethernet *unit/port*

unit - Unit identifier. (Range: 1)

port - Port number. (Range: 1-28/52)

port-channel *channel-id* (Range: 1-16)

DEFAULT SETTING

None

COMMAND MODE

Global Configuration

COMMAND USAGE

- ◆ Static multicast entries are never aged out.
- ◆ When a multicast entry is assigned to an interface in a specific VLAN, the corresponding traffic can only be forwarded to ports within that VLAN.

EXAMPLE

The following shows how to statically configure a multicast group on a port.

```
Console(config)#ip igmp snooping vlan 1 static 224.0.0.12 ethernet 1/5
Console(config)#
```

**clear ip igmp
snooping groups
dynamic** This command clears multicast group information dynamically learned through IGMP snooping.

SYNTAX

clear ip igmp snooping groups dynamic

COMMAND MODE

Privileged Exec

COMMAND USAGE

This command only clears entries learned through IGMP snooping. Statically configured multicast address are not cleared.

EXAMPLE

```
Console#clear ip igmp snooping groups dynamic
Console#
```

**clear ip igmp
snooping statistics**

This command clears IGMP snooping statistics.

SYNTAX

clear ip igmp snooping statistics [**interface** *interface*]

interface

ethernet *unit/port*

unit - Unit identifier. (Range: 1)

port - Port number. (Range: 1-28/52)

port-channel *channel-id* (Range: 1-16)

vlan *vlan-id* - VLAN identifier (Range: 1-4094)

COMMAND MODE

Privileged Exec

EXAMPLE

```
Console#clear ip igmp snooping statistics
Console#
```

**show ip igmp
snooping**

This command shows the IGMP snooping, proxy, and query configuration settings.

SYNTAX

show ip igmp snooping [**vlan** *vlan-id*]

vlan-id - VLAN ID (1-4094)

COMMAND MODE

Privileged Exec

COMMAND USAGE

This command displays global and VLAN-specific IGMP configuration settings. See "[Configuring IGMP Snooping and Query Parameters](#)" on [page 570](#) for a description of the displayed items.

EXAMPLE

The following shows the current IGMP snooping configuration:

```

Console#show ip igmp snooping
IGMP Snooping                : Enabled
Router Port Expire Time      : 300 s
Router Alert Check          : Disabled
Router Port Mode             : Forward
TCN Flood                    : Disabled
TCN Query Solicit           : Disabled
Unregistered Data Flood     : Disabled
802.1p Forwarding Priority   : Disabled
Unsolicited Report Interval : 400 s
Version Exclusive           : Disabled
Version                      : 2
Proxy Reporting              : Disabled
Querier                      : Disabled

VLAN 1:
-----
IGMP Snooping                : Enabled
IGMP Snooping Running Status : Inactive
Version                      : Using global Version (2)
Version Exclusive            : Using global status (Disabled)
Immediate Leave              : Disabled
Last Member Query Interval   : 10 (unit: 1/10s)
Last Member Query Count     : 2
General Query Suppression    : Disabled
Query Interval               : 125
Query Response Interval      : 100 (unit: 1/10s)
Proxy Query Address          : 0.0.0.0
Proxy Reporting              : Using global status (Disabled)
Multicast Router Discovery    : Disabled

VLAN Static Group   Port
-----
1      224.1.1.1     Eth 1/ 1
:

```

show ip igmp snooping group

This command shows known multicast group, source, and host port mappings for the specified VLAN interface, or for all interfaces if none is specified.

SYNTAX

show ip igmp snooping group [**host-ip-addr** *ip-address* *interface* | **igmpsn** | **sort-by-port** | **user** | **vlan** *vlan-id* [**user** | **igmpsn**]]

ip-address - IP address for multicast group

interface

ethernet *unit/port*

unit - Unit identifier. (Range: 1)

port - Port number. (Range: 1-28/52)

port-channel *channel-id* (Range: 1-16)

igmpsn - Display only entries learned through IGMP snooping.

sort-by-port - Display entries sorted by port.

user - Display only the user-configured multicast entries.

vlan-id - VLAN ID (1-4094)

DEFAULT SETTING

None

COMMAND MODE

Privileged Exec

COMMAND USAGE

Member types displayed include IGMP or USER, depending on selected options.

EXAMPLE

The following shows the multicast entries learned through IGMP snooping for VLAN 1.

```

Console#show ip igmp snooping group vlan 1
Bridge Multicast Forwarding Entry Count:1
Flag: R - Router port, M - Group member port
      H - Host counts (number of hosts join the group on this port).
      P - Port counts (number of ports join the group).
Up time: Group elapsed time (d:h:m:s).
Expire : Group remaining time (m:s).

VLAN Group          Port          Up time      Expire Count
-----
  1 224.1.1.1
      Eth 1/ 1(R)
      Eth 1/ 2(M)
                                         00:00:00:37
                                         2(P)
                                         0(H)

Console#
    
```

show ip igmp snooping mrouter This command displays information on statically configured and dynamically learned multicast router ports.

SYNTAX

show ip igmp snooping mrouter [**vlan** *vlan-id*]

vlan-id - VLAN ID (Range: 1-4094)

DEFAULT SETTING

Displays multicast router ports for all configured VLANs.

COMMAND MODE

Privileged Exec

COMMAND USAGE

Multicast router port types displayed include Static or Dynamic.

EXAMPLE

The following shows the ports in VLAN 1 which are attached to multicast routers.

```

Console#show ip igmp snooping mrouter vlan 1
VLAN M'cast Router Ports Type      Expire
-----
1    Eth 1/4                Dynamic 0:4:28
1    Eth 1/10               Static
Console#

```

show ip igmp snooping statistics

This command shows IGMP snooping protocol statistics for the specified interface.

SYNTAX

show ip igmp snooping statistics

{**input** [**interface** *interface*] |
output [**interface** *interface*] |
query [**vlan** *vlan-id*]}

interface

ethernet *unit/port*

unit - Unit identifier. (Range: 1)

port - Port number. (Range: 1-28/52)

port-channel *channel-id* (Range: 1-16)

vlan *vlan-id* - VLAN ID (Range: 1-4094)

query - Displays IGMP snooping-related statistics.

DEFAULT SETTING

None

COMMAND MODE

Privileged Exec

EXAMPLE

The following shows IGMP protocol statistics input:

```

Console#show ip igmp snooping statistics input interface ethernet 1/1
Interface Report  Leave    G Query  G(-S)-S Query Drop      Join Succ Group
-----
Eth 1/ 1          23       11        4          10          5          14          5
Console#

```

Table 165: show ip igmp snooping statistics input - display description

Field	Description
Interface	Shows interface.
Report	The number of IGMP membership reports received on this interface.
Leave	The number of leave messages received on this interface.
G Query	The number of general query messages received on this interface.
G(-S)-S Query	The number of group specific or group-and-source specific query messages received on this interface.
Drop	The number of times a report, leave or query was dropped. Packets may be dropped due to invalid format, rate limiting, or packet content not allowed.
Join Succ	The number of times a multicast group was successfully joined.
Group	The number of multicast groups active on this interface.

The following shows IGMP protocol statistics output:

```

Console#show ip igmp snooping statistics output interface ethernet 1/1
Output Statistics:
Interface  Report  Leave  G Query  G(-S)-S Query  Drop  Group
-----  -
Eth 1/ 1      12      0      1      0      0      0
Console#
    
```

Table 166: show ip igmp snooping statistics output - display description

Field	Description
Interface	Shows interface.
Report	The number of IGMP membership reports sent from this interface.
Leave	The number of leave messages sent from this interface.
G Query	The number of general query messages sent from this interface.
G(-S)-S Query	The number of group specific or group-and-source specific query messages sent from this interface.
Drop	The number of times a report, leave or query was dropped. Packets may be dropped due to invalid format, rate limiting, or packet content not allowed.
Group	The number of multicast groups active on this interface.

The following shows IGMP query-related statistics for VLAN 1:

```

Console#show ip igmp snooping statistics query vlan 1
Other Querier           : 192.168.0.1
Other Querier Expire    : 0(m):30(s)
Other Querier Uptime    : 0(h):55(m):0(s)
Self Querier           : 192.168.0.4
Self Querier Expire    : 0(m):0(s)
Self Querier Uptime    : 0(h):0(m):0(s)
General Query Received  : 10
General Query Sent     : 0
Specific Query Received : 2
Specific Query Sent    : 1
Warn Rate Limit        : 0 sec.
V1 Warning Count       : 0
V2 Warning Count       : 0
V3 Warning Count       : 0
Console#

```

Table 167: show ip igmp snooping statistics vlan query - display description

Field	Description
Other Querier	IP address of remote querier on this interface.
Other Querier Expire	Time after which remote querier is assumed to have expired.
Other Querier Uptime	Time remote querier has been up.
Self Querier	IP address of local querier on this interface.
Self Querier Expire	Time after which local querier is assumed to have expired.
Self Querier Uptime	Time local querier has been up.
General Query Received	The number of general queries received on this interface.
General Query Sent	The number of general queries sent from this interface.
Specific Query Received	The number of specific queries received on this interface.
Specific Query Sent	The number of specific queries sent from this interface.
Warn Rate Limit	The rate at which received query messages of the wrong version type cause the Vx warning count to increment. Note that "0 sec" means that the Vx warning count is incremented for each wrong message version received.
V1 Warning Count	The number of times the query version received (Version 1) does not match the version configured for this interface.
V2 Warning Count	The number of times the query version received (Version 2) does not match the version configured for this interface.
V3 Warning Count	The number of times the query version received (Version 3) does not match the version configured for this interface.

STATIC MULTICAST ROUTING

This section describes commands used to configure static multicast routing on the switch.

Table 168: Static Multicast Interface Commands

Command	Function	Mode
<code>ip igmp snooping vlan mrouter</code>	Adds a multicast router port	GC
<code>show ip igmp snooping mrouter</code>	Shows multicast router ports	PE

ip igmp snooping vlan mrouter This command statically configures a (Layer 2) multicast router port on the specified VLAN. Use the **no** form to remove the configuration.

SYNTAX

[no] ip igmp snooping vlan *vlan-id* mrouter *interface*

vlan-id - VLAN ID (Range: 1-4094)

interface

ethernet *unit/port*

unit - Unit identifier. (Range: 1)

port - Port number. (Range: 1-28/52)

port-channel *channel-id* (Range: 1-16)

DEFAULT SETTING

No static multicast router ports are configured.

COMMAND MODE

Global Configuration

COMMAND USAGE

- ◆ Depending on your network connections, IGMP snooping may not always be able to locate the IGMP querier. Therefore, if the IGMP querier is a known multicast router or switch connected over the network to an interface (port or trunk) on this switch, that interface can be manually configured to join all the current multicast groups.
- ◆ IGMP Snooping must be enabled globally on the switch (using the `ip igmp snooping` command) before a multicast router port can take effect.

EXAMPLE

The following shows how to configure port 10 as a multicast router port within VLAN 1.

```
Console(config)#ip igmp snooping vlan 1 mrouter ethernet 1/10
Console(config)#
```

IGMP FILTERING AND THROTTLING

In certain switch applications, the administrator may want to control the multicast services that are available to end users. For example, an IP/TV service based on a specific subscription plan. The IGMP filtering feature fulfills this requirement by restricting access to specified multicast services on a switch port, and IGMP throttling limits the number of simultaneous multicast groups a port can join.

Table 169: IGMP Filtering and Throttling Commands

Command	Function	Mode
<code>ip igmp filter</code>	Enables IGMP filtering and throttling on the switch	GC
<code>ip igmp profile</code>	Sets a profile number and enters IGMP filter profile configuration mode	GC
<code>permit, deny</code>	Sets a profile access mode to permit or deny	IPC
<code>range</code>	Specifies one or a range of multicast addresses for a profile	IPC
<code>ip igmp authentication</code>	Enables RADIUS authentication for IGMP JOIN requests.	IC
<code>ip igmp filter</code>	Assigns an IGMP filter profile to an interface	IC
<code>ip igmp max-groups</code>	Specifies an IGMP throttling number for an interface	IC
<code>ip igmp max-groups action</code>	Sets the IGMP throttling action for an interface	IC
<code>ip igmp query-drop</code>	Drops any received IGMP query packets	IC
<code>ip multicast-data-drop</code>	Drops all multicast data packets	IC
<code>show ip igmp authentication</code>	Displays the IGMP authentication setting for interfaces	PE
<code>show ip igmp filter</code>	Displays the IGMP filtering status	PE
<code>show ip igmp profile</code>	Displays IGMP profiles and settings	PE
<code>show ip igmp query-drop</code>	Shows if the interface is configured to drop IGMP query packets	PE
<code>show ip igmp throttle interface</code>	Displays the IGMP throttling setting for interfaces	PE
<code>show ip multicast-data-drop</code>	Shows if the interface is configured to drop multicast data packets	PE

ip igmp filter This command globally enables IGMP filtering and throttling on the switch.
(Global Configuration) Use the **no** form to disable the feature.

SYNTAX

[no] ip igmp filter

DEFAULT SETTING

Disabled

COMMAND MODE

Global Configuration

COMMAND USAGE

- ◆ IGMP filtering enables you to assign a profile to a switch port that specifies multicast groups that are permitted or denied on the port. An IGMP filter profile can contain one or more, or a range of multicast addresses; but only one profile can be assigned to a port. When enabled, IGMP join reports received on the port are checked against the filter profile. If a requested multicast group is permitted, the IGMP join report is forwarded as normal. If a requested multicast group is denied, the IGMP join report is dropped.
- ◆ IGMP filtering and throttling only applies to dynamically learned multicast groups, it does not apply to statically configured groups.
- ◆ The IGMP filtering feature operates in the same manner when MVR is used to forward multicast traffic.

EXAMPLE

```
Console(config)#ip igmp filter  
Console(config)#
```

ip igmp profile This command creates an IGMP filter profile number and enters IGMP profile configuration mode. Use the **no** form to delete a profile number.

SYNTAX

[no] ip igmp profile *profile-number*

profile-number - An IGMP filter profile number.
(Range: 1-4294967295)

DEFAULT SETTING

Disabled

COMMAND MODE

Global Configuration

COMMAND USAGE

A profile defines the multicast groups that a subscriber is permitted or denied to join. The same profile can be applied to many interfaces, but only one profile can be assigned to one interface. Each profile has only one access mode; either permit or deny.

EXAMPLE

```
Console(config)#ip igmp profile 19  
Console(config-igmp-profile)#
```

permit, deny This command sets the access mode for an IGMP filter profile. Use the **no** form to delete a profile number.

SYNTAX

{**permit** | **deny**}

DEFAULT SETTING

Deny

COMMAND MODE

IGMP Profile Configuration

COMMAND USAGE

- ◆ Each profile has only one access mode; either permit or deny.
- ◆ When the access mode is set to permit, IGMP join reports are processed when a multicast group falls within the controlled range. When the access mode is set to deny, IGMP join reports are only processed when a multicast group is not in the controlled range.

EXAMPLE

```
Console(config)#ip igmp profile 19  
Console(config-igmp-profile)#permit  
Console(config-igmp-profile)#
```

range This command specifies multicast group addresses for a profile. Use the **no** form to delete addresses from a profile.

SYNTAX

[**no**] **range** *low-ip-address* [*high-ip-address*]

low-ip-address - A valid IP address of a multicast group or start of a group range.

high-ip-address - A valid IP address for the end of a multicast group range.

DEFAULT SETTING

None

COMMAND MODE

IGMP Profile Configuration

COMMAND USAGE

Enter this command multiple times to specify more than one multicast address or address range for a profile.

EXAMPLE

```

Console(config)#ip igmp profile 19
Console(config-igmp-profile)#range 239.1.1.1
Console(config-igmp-profile)#range 239.2.3.1 239.2.3.100
Console(config-igmp-profile)#

```

ip igmp authentication

This command enables IGMP authentication on the specified interface. When enabled and an IGMP JOIN request is received, an authentication request is sent to a configured RADIUS server. Use the **no** form to disabled IGMP authentication.

SYNTAX

[no] ip igmp authentication

DEFAULT SETTING

Disabled

COMMAND MODE

Interface Configuration (Ethernet, Port Channel)

COMMAND USAGE

- ◆ If IGMP authentication is enabled on an interface, and a join report is received on the interface, the switch will send an access request to the RADIUS server to perform authentication.
- ◆ Only when the RADIUS server responds with an authentication success message will the switch learn the group report. Once the group is learned, the switch will not send an access request to the RADIUS server when receiving the same report again within a one (1) day period.
- ◆ If the RADIUS server responds that authentication failed or the timer expires, the report will be dropped and the group will not be learned. The entry (host MAC, port number, VLAN ID, and group IP) will be put in the "authentication failed list".
- ◆ The "authentication failed list" is valid for the period of the interval defined by the command [ip igmp snooping vlan query-interval](#). When receiving the same report during this interval, the switch will not send the access request to the RADIUS server.

- ◆ If the port leaves the group and subsequently rejoins the same group, the join report needs to again be authenticated.
- ◆ When receiving an IGMP v3 report message, the switch will send the access request to the RADIUS server only when the record type is either IS_EX or TO_EX, and the source list is empty. Other types of packets will not initiate RADIUS authentication.

IS_EX (MODE_IS_EXCLUDE) - Indicates that the interface's filter mode is EXCLUDE for the specified multicast address. The Source Address fields in this Group Record contain the interface's source list for the specified multicast address, if not empty.

TO_EX (CHANGE_TO_EXCLUDE_MODE) - Indicates that the interface has changed to EXCLUDE filter mode for the specified multicast address. The Source Address fields in this Group Record contain the interface's new source list for the specified multicast address, if not empty.
- ◆ When a report is received for the first time and is being authenticated, whether authentication succeeds or fails, the report will still be sent to the multicast-router port.
- ◆ The following table shows the RADIUS server Attribute Value Pairs used for authentication:

Table 170: IGMP Authentication RADIUS Attribute Value Pairs

Attribute Name	AVP Type	Entry
USER_NAME	1	User MAC address
USER_PASSWORD	2	User MAC address
NAS_IP_ADDRESS	4	Switch IP address
NAS_PORT	5	User Port Number
FRAMED_IP_ADDRESS	8	Multicast Group ID

EXAMPLE

This example shows how to enable IGMP Authentication on all of the switch's Ethernet interfaces.

```

Console(config)#interface ethernet 1/1-28
Console(config-if)#ip igmp authentication
Console#
  
```

RELATED COMMANDS

[show ip igmp authentication](#)

ip igmp filter This command assigns an IGMP filtering profile to an interface on the switch. Use the **no** form to remove a profile from an interface.
(Interface Configuration)

SYNTAX

[no] ip igmp filter *profile-number*

profile-number - An IGMP filter profile number.
(Range: 1-4294967295)

DEFAULT SETTING

None

COMMAND MODE

Interface Configuration

COMMAND USAGE

- ◆ The IGMP filtering profile must first be created with the [ip igmp profile](#) command before being able to assign it to an interface.
- ◆ Only one profile can be assigned to an interface.
- ◆ A profile can also be assigned to a trunk interface. When ports are configured as trunk members, the trunk uses the filtering profile assigned to the first port member in the trunk.

EXAMPLE

```
Console(config)#interface ethernet 1/1
Console(config-if)#ip igmp filter 19
Console(config-if)#
```

ip igmp max-groups This command sets the IGMP throttling number for an interface on the switch. Use the **no** form to restore the default setting.

SYNTAX

ip igmp max-groups *number*

no ip igmp max-groups

number - The maximum number of multicast groups an interface can join at the same time. (Range: 1-1023)

DEFAULT SETTING

1023

COMMAND MODE

Interface Configuration (Ethernet)

COMMAND USAGE

- ◆ IGMP throttling sets a maximum number of multicast groups that a port can join at the same time. When the maximum number of groups is

reached on a port, the switch can take one of two actions; either “deny” or “replace.” If the action is set to deny, any new IGMP join reports will be dropped. If the action is set to replace, the switch randomly removes an existing group and replaces it with the new multicast group.

- ◆ IGMP throttling can also be set on a trunk interface. When ports are configured as trunk members, the trunk uses the throttling settings of the first port member in the trunk.

EXAMPLE

```
Console(config)#interface ethernet 1/1
Console(config-if)#ip igmp max-groups 10
Console(config-if)#
```

ip igmp max-groups action This command sets the IGMP throttling action for an interface on the switch.

SYNTAX

ip igmp max-groups action {deny | replace}

deny - The new multicast group join report is dropped.

replace - The new multicast group replaces an existing group.

DEFAULT SETTING

Deny

COMMAND MODE

Interface Configuration (Ethernet)

COMMAND USAGE

When the maximum number of groups is reached on a port, the switch can take one of two actions; either “deny” or “replace.” If the action is set to deny, any new IGMP join reports will be dropped. If the action is set to replace, the switch randomly removes an existing group and replaces it with the new multicast group.

EXAMPLE

```
Console(config)#interface ethernet 1/1
Console(config-if)#ip igmp max-groups action replace
Console(config-if)#
```

ip igmp query-drop This command drops any received IGMP query packets. Use the **no** form to restore the default setting.

SYNTAX

[no] ip igmp query-drop [vlan *vlan-id*]

vlan-id - A VLAN identification number. (Range: 1-4094)

DEFAULT SETTING

Disabled

COMMAND MODE

Interface Configuration (Ethernet)

COMMAND USAGE

This command can be used to drop any query packets received on the specified interface. If this switch is acting as a Querier, this prevents it from being affected by messages received from another Querier.

EXAMPLE

```
Console(config)#interface ethernet 1/1
Console(config-if)#ip igmp query-drop vlan 2
Console(config-if)#
```

ip multicast-data-drop This command drops all multicast data packets. Use the **no** form to disable this feature.

SYNTAX

[no] ip multicast-data-drop

DEFAULT SETTING

Disabled

COMMAND MODE

Interface Configuration (Ethernet)

COMMAND USAGE

This command can be used to stop multicast services from being forwarded to users attached to the downstream port (i.e., the interfaces specified by this command).

EXAMPLE

```
Console(config)#interface ethernet 1/1
Console(config-if)#ip multicast-data-drop
Console(config-if)#
```

show ip igmp authentication This command displays the interface settings for IGMP authentication.

SYNTAX

```
show ip igmp authentication interface [interface]  
interface  
ethernet unit/port  
unit - Unit identifier. (Range: 1)  
port - Port number. (Range: 1-28/52)  
port-channel channel-id (Range: 1-16)
```

DEFAULT SETTING

None

COMMAND MODE

Privileged Exec

COMMAND USAGE

Using this command without specifying an interface displays information for all interfaces.

EXAMPLE

```
Console#show ip igmp authentication  
Ethernet 1/1: Enabled  
Ethernet 1/2: Enabled  
Ethernet 1/3: Enabled  
:  
Ethernet 1/27: Enabled  
Ethernet 1/28: Enabled  
Console#
```

show ip igmp filter This command displays the global and interface settings for IGMP filtering.

SYNTAX

```
show ip igmp filter [interface interface]  
interface  
ethernet unit/port  
unit - Unit identifier. (Range: 1)  
port - Port number. (Range: 1-28/52)  
port-channel channel-id (Range: 1-16)
```

DEFAULT SETTING

None

COMMAND MODE
Privileged Exec**EXAMPLE**

```
Console#show ip igmp filter
IGMP filter enabled
Console#show ip igmp filter interface ethernet 1/1
Ethernet 1/1 information
-----
IGMP Profile 19
Deny
Range 239.1.1.1 239.1.1.1
Range 239.2.3.1 239.2.3.100
Console#
```

show ip igmp profile This command displays IGMP filtering profiles created on the switch.

SYNTAX

show ip igmp profile [*profile-number*]

profile-number - An existing IGMP filter profile number.
(Range: 1-4294967295)

DEFAULT SETTING

None

COMMAND MODE
Privileged Exec**EXAMPLE**

```
Console#show ip igmp profile
IGMP Profile 19
IGMP Profile 50
Console#show ip igmp profile 19
IGMP Profile 19
Deny
Range 239.1.1.1 239.1.1.1
Range 239.2.3.1 239.2.3.100
Console#
```

show ip igmp query-drop This command shows if the specified interface is configured to drop IGMP query packets.

SYNTAX

```
show ip igmp throttle interface [interface]  
interface  
ethernet unit/port  
unit - Stack unit. (Range: 1)  
port - Port number. (Range: 1-28/52)  
port-channel channel-id (Range: 1-16)
```

DEFAULT SETTING

None

COMMAND MODE

Privileged Exec

COMMAND USAGE

Using this command without specifying an interface displays all interfaces.

EXAMPLE

```
Console#show ip igmp query-drop interface ethernet 1/1  
Ethernet 1/1: Enabled  
Console#
```

show ip igmp throttle interface This command displays the interface settings for IGMP throttling.

SYNTAX

```
show ip igmp throttle interface [interface]  
interface  
ethernet unit/port  
unit - Unit identifier. (Range: 1)  
port - Port number. (Range: 1-28/52)  
port-channel channel-id (Range: 1-16)
```

DEFAULT SETTING

None

COMMAND MODE

Privileged Exec

COMMAND USAGE

Using this command without specifying an interface displays information for all interfaces.

EXAMPLE

```
Console#show ip igmp throttle interface ethernet 1/1
Eth 1/1 Information
  Status : TRUE
  Action : Deny
  Max Multicast Groups : 32
  Current Multicast Groups : 0

Console#
```

show ip multicast-data-drop This command shows if the specified interface is configured to drop multicast data packets.

SYNTAX

show ip igmp throttle interface [*interface*]

interface

ethernet *unit/port*

unit - Unit identifier. (Range: 1)

port - Port number. (Range: 1-28/52)

port-channel *channel-id* (Range: 1-16)

DEFAULT SETTING

None

COMMAND MODE

Privileged Exec

COMMAND USAGE

Using this command without specifying an interface displays all interfaces.

EXAMPLE

```
Console#show ip multicast-data-drop interface ethernet 1/1
Ethernet 1/1: Enabled
Console#
```

MLD SNOOPING

Multicast Listener Discovery (MLD) snooping operates on IPv6 traffic and performs a similar function to IGMP snooping for IPv4. That is, MLD snooping dynamically configures switch ports to limit IPv6 multicast traffic so that it is forwarded only to ports with users that want to receive it. This reduces the flooding of IPv6 multicast packets in the specified VLANs.

There are two versions of the MLD protocol, version 1 and version 2. MLDv1 control packets include Listener Query, Listener Report, and Listener Done messages (equivalent to IGMPv2 query, report, and leave messages). MLDv2 control packets include MLDv2 query and report messages, as well as MLDv1 report and done messages.

Remember that IGMP Snooping and MLD Snooping are independent functions, and can therefore both function at the same time.



NOTE: Due to an ASIC limitation in the ECS4110-52T, MLDv2 reports with source list is not supported. The switch can only process IS_EX (is excluded), TO_EX (change to excluded), and TO_IN (change to included) records without source list.

Table 171: MLD Snooping Commands

Command	Function	Mode
<code>ipv6 mld snooping</code>	Enables MLD Snooping globally	GC
<code>ipv6 mld snooping querier</code>	Allows the switch to act as the querier for MLD snooping	GC
<code>ipv6 mld snooping query-interval</code>	Configures the interval between sending MLD general query messages	GC
<code>ipv6 mld snooping query-max-response-time</code>	Configures the maximum response time for a general queries	GC
<code>ipv6 mld snooping robustness</code>	Configures the robustness variable	GC
<code>ipv6 mld snooping router-port-expire-time</code>	Configures the router port expire time	GC
<code>ipv6 mld snooping unknown-multicast mode</code>	Sets an action for unknown multicast packets	GC
<code>ipv6 mld snooping version</code>	Configures the MLD Snooping version	GC
<code>ipv6 mld snooping vlan immediate-leave</code>	Removes a member port of an IPv6 multicast service if a leave packet is received at that port and MLD immediate-leave is enabled for the parent VLAN	GC
<code>ipv6 mld snooping vlan mrouter</code>	Adds an IPv6 multicast router port	GC
<code>ipv6 mld snooping vlan static</code>	Adds an interface as a member of a multicast group	GC
<code>clear ip igmp snooping groups dynamic</code>	Clears multicast group information dynamically learned through MLD snooping or MVR6	PE
<code>clear ip igmp snooping statistics</code>	Clears clears IGMP snooping statistics	PE

Table 171: MLD Snooping Commands (Continued)

Command	Function	Mode
<code>show ipv6 mld snooping</code>	Displays MLD Snooping configuration	PE
<code>show ipv6 mld snooping group</code>	Displays the learned groups	PE
<code>show ipv6 mld snooping group source-list</code>	Displays the learned groups and corresponding source list	PE
<code>show ipv6 mld snooping mrouter</code>	Displays the information of multicast router ports	PE

ipv6 mld snooping This command enables MLD Snooping globally on the switch. Use the **no** form to disable MLD Snooping.

SYNTAX

[no] ipv6 mld snooping

DEFAULT SETTING

Disabled

COMMAND MODE

Global Configuration

EXAMPLE

The following example enables MLD Snooping:

```
Console(config)#ipv6 mld snooping
Console(config)#
```

ipv6 mld snooping querier This command allows the switch to act as the querier for MLDv2 snooping. Use the **no** form to disable this feature.

SYNTAX

[no] ipv6 mld snooping querier

DEFAULT SETTING

Disabled

COMMAND MODE

Global Configuration

COMMAND USAGE

- ◆ If enabled, the switch will serve as querier if elected. The querier is responsible for asking hosts if they want to receive multicast traffic.

- ◆ An IPv6 address must be configured on the VLAN interface from which the querier will act if elected. When serving as the querier, the switch uses its own IPv6 address as the query source address.
- ◆ The querier will not start or will disable itself after having started if it detects an IPv6 multicast router on the network.

EXAMPLE

```
Console(config)#ipv6 mld snooping querier  
Console(config)#
```

ipv6 mld snooping query-interval This command configures the interval between sending MLD general queries. Use the **no** form to restore the default.

SYNTAX

ipv6 mld snooping query-interval *interval*

no ipv6 mld snooping query-interval

interval - The interval between sending MLD general queries.
(Range: 60-125 seconds)

DEFAULT SETTING

125 seconds

COMMAND MODE

Global Configuration

COMMAND USAGE

- ◆ This command applies when the switch is serving as the querier.
- ◆ An MLD general query message is sent by the switch at the interval specified by this command. When this message is received by downstream hosts, all receivers build an MLD report for the multicast groups they have joined.

EXAMPLE

```
Console(config)#ipv6 mld snooping query-interval 150  
Console(config)#
```

ipv6 mld snooping query-max-response-time This command configures the maximum response time advertised in MLD general queries. Use the **no** form to restore the default.

SYNTAX

ipv6 mld snooping query-max-response-time *seconds*

no ipv6 mld snooping query-max-response-time

seconds - The maximum response time allowed for MLD general queries. (Range: 5-25 seconds)

DEFAULT SETTING

10 seconds

COMMAND MODE

Global Configuration

COMMAND USAGE

This command controls how long the host has to respond to an MLD Query message before the switch deletes the group if it is the last member.

EXAMPLE

```
Console(config)#ipv6 mld snooping query-max-response-time seconds 15
Console(config)#
```

ipv6 mld snooping robustness This command configures the MLD Snooping robustness variable. Use the **no** form to restore the default value.

SYNTAX

ipv6 mld snooping robustness *value*

no ipv6 mld snooping robustness

value - The number of the robustness variable. (Range: 2-10)

DEFAULT SETTING

2

COMMAND MODE

Global Configuration

COMMAND USAGE

A port will be removed from the receiver list for a multicast service when no MLD reports are detected in response to a number of MLD queries. The robustness variable sets the number of queries on ports for which there is no report.

EXAMPLE

```
Console(config)#ipv6 mld snooping robustness 2  
Console(config)#
```

ipv6 mld snooping router-port-expire- time

This command configures the MLD query timeout. Use the **no** form to restore the default.

SYNTAX

ipv6 mld snooping router-port-expire-time *time*

no ipv6 mld snooping router-port-expire-time

time - Specifies the timeout of a dynamically learned router port.
(Range: 300-500 seconds)

DEFAULT SETTING

300 seconds

COMMAND MODE

Global Configuration

COMMAND USAGE

The router port expire time is the time the switch waits after the previous querier stops before it considers the router port (i.e., the interface that had been receiving query packets) to have expired.

EXAMPLE

```
Console(config)#ipv6 mld snooping router-port-expire-time 300  
Console(config)#
```

ipv6 mld snooping unknown-multicast mode

This command sets the action for dealing with unknown multicast packets. Use the **no** form to restore the default.

SYNTAX

ipv6 mld snooping unknown-multicast mode {**flood** |
to-router-port}

no ipv6 mld snooping unknown-multicast mode

flood - Floods the unknown multicast data packets to all ports.

to-router-port - Forwards the unknown multicast data packets to router ports.

DEFAULT SETTING

to-router-port

COMMAND MODE

Global Configuration

COMMAND USAGE

- ◆ When set to "flood," any received IPv6 multicast packets that have not been requested by a host are flooded to all ports in the VLAN.
- ◆ When set to "router-port," any received IPv6 multicast packets that have not been requested by a host are forwarded to ports that are connected to a detected multicast router.

EXAMPLE

```
Console(config)#ipv6 mld snooping unknown-multicast mode flood
Console(config)#
```

ipv6 mld snooping version This command configures the MLD snooping version. Use the **no** form to restore the default.

SYNTAX

ipv6 mld snooping version {1 | 2}

1 - MLD version 1.

2 - MLD version 2.

DEFAULT SETTING

Version 2

COMMAND MODE

Global Configuration

EXAMPLE

```
Console(config)#ipv6 mld snooping version 1
Console(config)#
```

ipv6 mld snooping vlan immediate-leave This command immediately deletes a member port of an IPv6 multicast service when a leave packet is received at that port and immediate-leave is enabled for the parent VLAN. Use the **no** form to restore the default.

SYNTAX

[no] ipv6 mld snooping vlan *vlan-id* immediate-leave

vlan-id - A VLAN identification number. (Range: 1-4094)

DEFAULT SETTING

Disabled

COMMAND MODE

Global Configuration

COMMAND USAGE

- ◆ If MLD immediate-leave is *not* used, a multicast router (or querier) will send a group-specific query message when an MLD group leave message is received. The router/querier stops forwarding traffic for that group only if no host replies to the query within the specified timeout period.
- ◆ If MLD immediate-leave is enabled, the switch assumes that only one host is connected to the interface. Therefore, immediate leave should only be enabled on an interface if it is connected to only one MLD-enabled device, either a service host or a neighbor running MLD snooping.

EXAMPLE

The following shows how to enable MLD immediate leave.

```
Console(config)#interface vlan 1
Console(config-if)#ipv6 mld snooping immediate-leave
Console(config-if)#
```

ipv6 mld snooping vlan mrouter

This command statically configures an IPv6 multicast router port. Use the **no** form to remove the configuration.

SYNTAX

[no] ipv6 mld snooping vlan *vlan-id* mrouter *interface*

vlan-id - VLAN ID (Range: 1-4094)

interface

ethernet *unit/port*

unit - Stack unit. (Range: 1)

port - Port number. (Range: 1-28/52)

port-channel *channel-id* (Range: 1-16)

DEFAULT SETTING

No static multicast router ports are configured.

COMMAND MODE

Global Configuration

COMMAND USAGE

Depending on your network connections, MLD snooping may not always be able to locate the MLD querier. Therefore, if the MLD querier is a known multicast router/switch connected over the network to an interface (port or trunk) on the switch, you can manually configure that interface to join all the current multicast groups.

EXAMPLE

The following shows how to configure port 1 as a multicast router port within VLAN 1:

```
Console(config)#ipv6 mld snooping vlan 1 mrouter ethernet 1/1
Console(config)#
```

**ipv6 mld snooping
vlan static**

This command adds a port to an IPv6 multicast group. Use the **no** form to remove the port.

SYNTAX

[no] ipv6 mld snooping vlan *vlan-id* static *ipv6-address* interface

vlan - VLAN ID (Range: 1-4094)

ipv6-address - An IPv6 address of a multicast group.
(Format: X:X:X:X::X)

interface

ethernet *unit/port*

unit - Stack unit. (Range: 1)

port - Port number. (Range: 1-28/52)

port-channel *channel-id* (Range: 1-16)

DEFAULT SETTING

None

COMMAND MODE

Global Configuration

EXAMPLE

```
Console(config)#ipv6 mld snooping vlan 1 static FF00:0:0:0:0:0:10C ethernet
1/6
Console(config)#
```

**clear ipv6 mld
snooping groups
dynamic**

This command clears multicast group information dynamically learned through MLD snooping.

SYNTAX

clear ipv6 mld snooping groups dynamic

COMMAND MODE

Privileged Exec

COMMAND USAGE

This command only clears entries learned through MLD snooping. Statically configured multicast addresses are not cleared.

EXAMPLE

```
Console#clear ipv6 mld snooping groups dynamic
Console#
```

clear ipv6 mld snooping statistics

This command clears MLD snooping statistics.

SYNTAX

clear ipv6 mld snooping statistics [**interface** *interface*]

interface

ethernet *unit/port*

unit - Unit identifier. (Range: 1)

port - Port number. (Range: 1-28/52)

port-channel *channel-id* (Range: 1-16)

vlan *vlan-id* - VLAN identifier (Range: 1-4094)

COMMAND MODE

Privileged Exec

EXAMPLE

```
Console#clear ipv6 mld snooping statistics
Console#
```

show ipv6 mld snooping

This command shows the current MLD Snooping configuration.

SYNTAX

show ipv6 mld snooping

COMMAND MODE

Privileged Exec

EXAMPLE

The following shows MLD Snooping configuration information

```
Console#show ipv6 mld snooping
Service Status           : Disabled
Querier Status           : Disabled
Robustness               : 2
Query Interval           : 125 sec
Query Max Response Time  : 10 sec
```

```
Router Port Expiry Time      : 300 sec
Immediate Leave              : Disabled on all VLAN
Unknown Flood Behavior       : To Router Port
MLD Snooping Version        : Version 2
Console#
```

show ipv6 mld snooping group This command shows known multicast groups, member ports, and the means by which each group was learned.

SYNTAX

show ipv6 mld snooping group

COMMAND MODE

Privileged Exec

EXAMPLE

The following shows MLD Snooping group configuration information:

```
Console#show ipv6 mld snooping group

VLAN Multicast IPv6 Address      Member port Type
-----
  1 FF02::01:01:01:01            Eth 1/1      MLD Snooping
  1 FF02::01:01:01:02            Eth 1/1      Multicast Data
  1 FF02::01:01:01:02            Eth 1/1      User

Console#
```

show ipv6 mld snooping group source-list This command shows known multicast groups, member ports, the means by which each group was learned, and the corresponding source list.

SYNTAX

show ipv6 mld snooping group source-list

COMMAND MODE

Privileged Exec

EXAMPLE

The following shows MLD Snooping group mapping information:

```
Console#show ipv6 mld snooping group source-list

Console#show ipv6 mld snooping group source-list
VLAN ID          : 1
Multicast IPv6 Address : FF02::01:01:01:01
Member Port      : Eth 1/1
Type             : MLD Snooping
Filter Mode      : Include
(if exclude filter mode)
Filter Timer elapse : 10 sec.
```

```

Request List           : ::01:02:03:04, ::01:02:03:05, ::01:02:03:06,
                       : ::01:02:03:07
Exclude List          : ::02:02:03:04, ::02:02:03:05, ::02:02:03:06,
                       : ::02:02:03:07
(if include filter mode)
Include List          : ::02:02:03:04, ::02:02:03:05, ::02:02:03:06,
                       : ::02:02:03:06

Option:
Filter Mode: Include, Exclude

Console#

```

show ipv6 mld snooping mrouter

This command shows MLD Snooping multicast router information.

SYNTAX

show ipv6 mld snooping mrouter vlan *vlan-id*

vlan-id - A VLAN identification number. (Range: 1-4094)

COMMAND MODE

Privileged Exec

EXAMPLE

```

Console#show ipv6 mld snooping mrouter vlan 1
VLAN Multicast Router Port Type      Expire
-----
  1 Eth 1/ 2                Static

Console#

```

MLD FILTERING AND THROTTLING

In certain switch applications, the administrator may want to control the multicast services that are available to end users. For example, an IP/TV service based on a specific subscription plan. The MLD filtering feature fulfills this requirement by restricting access to specified multicast services on a switch port, and MLD throttling limits the number of simultaneous multicast groups a port can join.

Table 172: IGMP Filtering and Throttling Commands

Command	Function	Mode
ipv6 mld filter	Enables MLD filtering and throttling on the switch	GC
ipv6 mld profile	Sets a profile number and enters MLD filter profile configuration mode	GC
permit, deny	Sets a profile access mode to permit or deny	IPC
range	Specifies one or a range of multicast addresses for a profile	IPC

Table 172: IGMP Filtering and Throttling Commands (Continued)

Command	Function	Mode
<code>ipv6 mld filter</code> (Interface Configuration)	Assigns an MLD filter profile to an interface	IC
<code>ipv6 mld max-groups</code>	Specifies an M:D throttling number for an interface	IC
<code>ipv6 mld max-groups action</code>	Sets the MLD throttling action for an interface	IC
<code>ipv6 mld query-drop</code>	Drops any received MLD query packets	IC
<code>ipv6 multicast-data-drop</code>	Enable multicast data guard mode on a port interface	IC
<code>show ipv6 mld filter</code>	Displays the MLD filtering status	PE
<code>show ipv6 mld profile</code>	Displays MLD profiles and settings	PE
<code>show ipv6 mld query-drop</code>	Shows if the interface is configured to drop MLD query packets	PE
<code>show ipv6 mld throttle interface</code>	Displays the MLD throttling setting for interfaces	PE

ipv6 mld filter This command globally enables MLD filtering and throttling on the switch.
(Global Configuration) Use the **no** form to disable the feature.

SYNTAX

[no] ipv6 mld filter

DEFAULT SETTING

Disabled

COMMAND MODE

Global Configuration

COMMAND USAGE

- ◆ MLD filtering enables you to assign a profile to a switch port that specifies multicast groups that are permitted or denied on the port. An MLD filter profile can contain one or more, or a range of multicast addresses; but only one profile can be assigned to a port. When enabled, MLD join reports received on the port are checked against the filter profile. If a requested multicast group is permitted, the MLD join report is forwarded as normal. If a requested multicast group is denied, the MLD join report is dropped.
- ◆ MLD filtering and throttling only applies to dynamically learned multicast groups, it does not apply to statically configured groups.
- ◆ The MLD filtering feature operates in the same manner when MVR is used to forward multicast traffic.

EXAMPLE

```
Console(config)#ipv6 mld filter
Console(config)#
```

RELATED COMMANDS

[show ipv6 mld filter](#)

ipv6 mld profile This command creates an MLD filter profile number and enters MLD profile configuration mode. Use the **no** form to delete a profile number.

SYNTAX

[no] ipv6 mld profile *profile-number*

profile-number - An MLD filter profile number.
(Range: 1-4294967295)

DEFAULT SETTING

Disabled

COMMAND MODE

Global Configuration

COMMAND USAGE

A profile defines the multicast groups that a subscriber is permitted or denied to join. The same profile can be applied to many interfaces, but only one profile can be assigned to one interface. Each profile has only one access mode; either permit or deny.

EXAMPLE

```
Console(config)#ipv6 mld profile 19
Console(config-mld-profile)#
```

RELATED COMMANDS

[show ipv6 mld profile](#)

permit, deny This command sets the access mode for an MLD filter profile. Use the **no** form to delete a profile number.

SYNTAX

{**permit** | **deny**}

DEFAULT SETTING

deny

COMMAND MODE

MLD Profile Configuration

COMMAND USAGE

◆ Each profile has only one access mode; either permit or deny.

- ◆ When the access mode is set to permit, MLD join reports are processed when a multicast group falls within the controlled range. When the access mode is set to deny, MLD join reports are only processed when a multicast group is not in the controlled range.

EXAMPLE

```
Console(config)#ipv6 mld profile 19
Console(config-mld-profile)#permit
Console(config-mld-profile)#
```

range This command specifies multicast group addresses for a profile. Use the **no** form to delete addresses from a profile.

SYNTAX

[no] range *low-ipv6-address* [*high-ipv6-address*]

low-ipv6-address - A valid IPv6 address (X:X:X:X::X) of a multicast group or start of a group range.

high-ipv6-address - A valid IPv6 address (X:X:X:X::X) for the end of a multicast group range.

DEFAULT SETTING

None

COMMAND MODE

MLD Profile Configuration

COMMAND USAGE

Enter this command multiple times to specify more than one multicast address or address range for a profile.

EXAMPLE

```
Console(config-mld-profile)#range ff01::0101 ff01::0202
Console(config-mld-profile)#
```

ipv6 mld filter

(Interface Configuration)

This command assigns an MLD filtering profile to an interface on the switch. Use the **no** form to remove a profile from an interface.

SYNTAX

[no] ipv6 mld filter *profile-number*

profile-number - An MLD filter profile number.
(Range: 1-4294967295)

DEFAULT SETTING

None

COMMAND MODE

Interface Configuration

COMMAND USAGE

- ◆ The MLD filtering profile must first be created with the `ipv6 mld profile` command before being able to assign it to an interface.
- ◆ Only one profile can be assigned to an interface.
- ◆ A profile can also be assigned to a trunk interface. When ports are configured as trunk members, the trunk uses the filtering profile assigned to the first port member in the trunk.

EXAMPLE

```
Console(config)#interface ethernet 1/1
Console(config-if)#ipv6 mld filter 19
Console(config-if)#
```

ipv6 mld max-groups

This command configures the maximum number of MLD groups that an interface can join. Use the **no** form restore the default setting.

SYNTAX

ipv6 mld max-groups *number*

no ipv6 mld max-groups

number - The maximum number of multicast groups an interface can join at the same time. (Range: 1-1023)

DEFAULT SETTING

1023

COMMAND MODE

Interface Configuration (Ethernet)

COMMAND USAGE

- ◆ MLD throttling sets a maximum number of multicast groups that a port can join at the same time. When the maximum number of groups is reached on a port, the switch can take one of two actions; either "deny" or "replace." If the action is set to deny, any new MLD join reports will be dropped. If the action is set to replace, the switch randomly removes an existing group and replaces it with the new multicast group.
- ◆ MLD throttling can also be set on a trunk interface. When ports are configured as trunk members, the trunk uses the throttling settings of the first port member in the trunk.

- ◆ If the maximum number of MLD groups is set to the default value, the running status of MLD throttling will change to false. This means that any configuration for MLD throttling will have no effect until the maximum number of MLD groups is configured to another value.

EXAMPLE

```
Console(config)#interface ethernet 1/1
Console(config-if)#ipv6 mld max-groups 10
Console(config-if)#
```

**ipv6 mld
max-groups action**

This command sets the MLD throttling action for an interface on the switch.

SYNTAX

ipv6 mld max-groups action {deny | replace}

deny - The new multicast group join report is dropped.

replace - The new multicast group replaces an existing group.

DEFAULT SETTING

Deny

COMMAND MODE

Interface Configuration (Ethernet)

COMMAND USAGE

When the maximum number of groups is reached on a port, the switch can take one of two actions; either "deny" or "replace." If the action is set to deny, any new MLD join reports will be dropped. If the action is set to replace, the switch randomly removes an existing group and replaces it with the new multicast group.

EXAMPLE

```
Console(config)#interface ethernet 1/1
Console(config-if)#ipv6 mld max-groups action replace
Console(config-if)#
```

ipv6 mld query-drop

This command drops any received MLD query packets. Use the **no** form to restore the default setting.

SYNTAX

[no] ipv6 mld query-drop

DEFAULT SETTING

Disabled

COMMAND MODE

Interface Configuration (Ethernet)

COMMAND USAGE

This command can be used to drop any query packets received on the specified interface. If this switch is acting as a Querier, this prevents it from being affected by messages received from another Querier.

EXAMPLE

```
Console(config)#interface ethernet 1/1
Console(config-if)#ipv6 mld query-drop
Console(config-if)#
```

ipv6 multicast-data-drop

Use this command to enable multicast data guard mode on a port interface. Use the **no** form of the command to disable multicast data guard.

SYNTAX

[no] ipv6 multicast-data-drop

DEFAULT SETTING

Disabled

COMMAND MODE

Interface Configuration

EXAMPLE

```
Console(config)#interface ethernet 1/3
Console(config-if)#ipv6 multicast-data-drop
Console(config-if)#
```

show ipv6 mld filter This command displays the global and interface settings for MLD filtering.

SYNTAX

show ipv6 mld filter [**interface** *interface*]

interface

ethernet *unit/port*

unit - Unit identifier. (Range: 1)

port - Port number. (Range: 1-28/52)

port-channel *channel-id* (Range: 1-16)

DEFAULT SETTING

None

COMMAND MODE
Privileged Exec

EXAMPLE

```
Console#show ipv6 mld filter
MLD filter Enabled
Console#show ipv6 mld filter interface ethernet 1/3
Ethernet 1/3 information
-----
MLD Profile 19
Deny
Range ff05::101          ff05::103
Console#
```

show ipv6 mld profile This command displays MLD filtering profiles created on the switch.

SYNTAX

show ipv6 mld profile [*profile-number*]

profile-number - An existing MLD filter profile number.
(Range: 1-4294967295)

DEFAULT SETTING

None

COMMAND MODE

Privileged Exec

EXAMPLE

```
Console#show ipv6 mld profile
MLD Profile 19
MLD Profile 50
Console#show ipv6 mld profile 19
Console#show ipv6 mld profile 5
MLD Profile 19
Deny
Range ff05::101          ff05::103
```

show ipv6 mld query-drop This command shows if the specified interface is configured to drop MLD query packets.

SYNTAX

```
show ipv6 mld throttle interface [interface]  
interface  
ethernet unit/port  
unit - Stack unit. (Range: 1)  
port - Port number. (Range: 1-28/52)  
port-channel channel-id (Range: 1-16)
```

DEFAULT SETTING

None

COMMAND MODE

Privileged Exec

COMMAND USAGE

Using this command without specifying an interface displays all interfaces.

EXAMPLE

```
Console#show ipv6 mld query-drop interface ethernet 1/1  
Ethernet 1/1: Enabled  
Console#
```

show ipv6 mld throttle interface This command displays the interface settings for MLD throttling.

SYNTAX

```
show ipv6 mld throttle interface [interface]  
interface  
ethernet unit/port  
unit - Unit identifier. (Range: 1)  
port - Port number. (Range: 1-28/52)  
port-channel channel-id (Range: 1-16)
```

DEFAULT SETTING

None

COMMAND MODE

Privileged Exec

COMMAND USAGE

Using this command without specifying an interface displays information for all interfaces.

EXAMPLE

```

Console#show ipv6 mld throttle interface ethernet 1/3
Eth 1/3 Information
  Status          : TRUE
  Action          : Replace
  Max Multicast Groups : 10
  Current Multicast Groups : 0

Console#

```

MVR FOR IPv4

This section describes commands used to configure Multicast VLAN Registration for IPv4 (MVR). A single network-wide VLAN can be used to transmit multicast traffic (such as television channels) across a service provider’s network. Any multicast traffic entering an MVR VLAN is sent to all subscribers. This can significantly reduce to processing overhead required to dynamically monitor and establish the distribution tree for a normal multicast VLAN. Also note that MVR maintains the user isolation and data security provided by VLAN segregation by passing only multicast traffic into other VLANs to which the subscribers belong.

Table 173: Multicast VLAN Registration for IPv4 Commands

Command	Function	Mode
<code>mvr</code>	Globally enables MVR	GC
<code>mvr associated-profile</code>	Binds the MVR group addresses specified in a profile to an MVR domain	GC
<code>mvr domain</code>	Enables MVR for a specific domain	GC
<code>mvr6 priority</code>	Assigns a priority to all multicast traffic in the MVR VLAN	GC
<code>mvr profile</code>	Maps a range of MVR group addresses to a profile	GC
<code>mvr proxy-query-interval</code>	Configures the interval at which the receiver port sends out general queries.	GC
<code>mvr proxy-switching</code>	Enables MVR proxy switching, where the source port acts as a host, and the receiver port acts as an MVR router with querier service enabled	GC
<code>mvr robustness-value</code>	Configures the expected packet loss, and thereby the number of times to generate report and group-specific queries	GC
<code>mvr source-port-mode dynamic</code>	Configures the switch to only forward multicast streams which the source port has dynamically joined	GC
<code>mvr upstream-source-ip</code>	Configures the source IP address assigned to all control packets sent upstream	GC
<code>mvr vlan</code>	Specifies the VLAN through which MVR multicast data is received	GC

Table 173: Multicast VLAN Registration for IPv4 Commands (Continued)

Command	Function	Mode
<code>mvr immediate-leave</code>	Enables immediate leave capability	IC
<code>mvr type</code>	Configures an interface as an MVR receiver or source port	IC
<code>mvr vlan group</code>	Statically binds a multicast group to a port	IC
<code>clear mrv groups dynamic</code>	Clears multicast group information dynamically learned through MVR	PE
<code>clear mrv statistics</code>	Clears MRV statistics	PE
<code>show mvr</code>	Shows information about MVR domain settings, including MVR operational status, the multicast VLAN, the current number of group addresses, and the upstream source IP address	PE
<code>show mvr associated-profile</code>	Shows the profiles bound the specified domain	PE
<code>show mvr interface</code>	Shows MVR settings for interfaces attached to the MVR VLAN	PE
<code>show mvr members</code>	Shows information about the current number of entries in the forwarding database, or detailed information about a specific multicast address	PE
<code>show mvr profile</code>	Shows all configured MVR profiles	PE
<code>show mvr statistics</code>	Shows MVR protocol statistics for the specified interface	PE

mvr This command enables Multicast VLAN Registration (MVR) globally on the switch. Use the **no** form of this command to globally disable MVR.

SYNTAX

`[no] mvr`

DEFAULT SETTING

Disabled

COMMAND MODE

Global Configuration

COMMAND USAGE

Only IGMP version 2 or 3 hosts can issue multicast join or leave messages. If MVR must be configured for an IGMP version 1 host, the multicast groups must be statically assigned using the `mvr vlan group` command.

EXAMPLE

The following example enables MVR globally.

```

Console(config)#mvr
Console(config)#

```

mvr associated-profile This command binds the MVR group addresses specified in a profile to an MVR domain. Use the **no** form of this command to remove the binding.

SYNTAX

[no] mvr domain *domain-id* **associated-profile** *profile-name*

domain-id - An independent multicast domain. (Range: 1-5)

profile-name - The name of a profile containing one or more MVR group addresses. (Range: 1-21 characters)

DEFAULT SETTING

Disabled

COMMAND MODE

Global Configuration

EXAMPLE

The following an MVR group address profile to domain 1:

```
Console(config)#mvr domain 1 associated-profile rd
Console(config)#
```

RELATED COMMANDS

[mvr profile \(1284\)](#)

mvr domain This command enables Multicast VLAN Registration (MVR) for a specific domain. Use the **no** form of this command to disable MVR for a domain.

SYNTAX

[no] mvr domain *domain-id*

domain-id - An independent multicast domain. (Range: 1-5)

DEFAULT SETTING

Disabled

COMMAND MODE

Global Configuration

COMMAND USAGE

Only IGMP version 2 or 3 hosts can issue multicast join or leave messages. If MVR must be configured for an IGMP version 1 host, the multicast groups must be statically assigned using the [mvr vlan group](#) command.

EXAMPLE

The following example enables MVR for domain 1:

```
Console(config)#mvr domain 1
Console(config)#
```

mvr priority This command assigns a priority to all multicast traffic in the MVR VLAN. Use the **no** form of this command to restore the default setting.

SYNTAX

mvr priority *priority*

no mvr priority

priority - The CoS priority assigned to all multicast traffic forwarded into the MVR VLAN. (Range: 0-7, where 7 is the highest priority)

DEFAULT SETTING

Disabled

COMMAND MODE

Global Configuration

COMMAND USAGE

This command can be used to set a high priority for low-latency multicast traffic such as a video-conference, or to set a low priority for normal multicast traffic not sensitive to latency.

EXAMPLE

```
Console(config)#mvr priority 6
Console(config)#
```

RELATED COMMANDS

[show mvr](#)

mvr profile This command maps a range of MVR group addresses to a profile. Use the **no** form of this command to remove the profile.

SYNTAX

mvr profile *profile-name start-ip-address end-ip-address*

profile-name - The name of a profile containing one or more MVR group addresses. (Range: 1-21 characters)

start-ip-address - Starting IPv4 address for an MVR multicast group. (Range: 224.0.1.0 - 239.255.255.255)

end-ip-address - Ending IPv4 address for an MVR multicast group. (Range: 224.0.1.0 - 239.255.255.255)

DEFAULT SETTING

No profiles are defined

COMMAND MODE

Global Configuration

COMMAND USAGE

- ◆ Use this command to statically configure all multicast group addresses that will join the MVR VLAN. Any multicast data associated an MVR group is sent from all source ports to all receiver ports that have registered to receive data from that multicast group.
- ◆ The IP address range from 224.0.0.0 to 239.255.255.255 is used for multicast streams. MVR group addresses cannot fall within the reserved IP multicast address range of 224.0.0.x.
- ◆ IGMP snooping and MVR share a maximum number of 1023 groups. Any multicast streams received in excess of this limitation will be flooded to all ports in the associated domain.

EXAMPLE

The following example maps a range of MVR group addresses to a profile:

```
Console(config)#mvr profile rd 228.1.23.1 228.1.23.10
Console(config)#
```

mvr proxy-query-interval This command configures the interval at which the receiver port sends out general queries. Use the **no** form to restore the default setting.

SYNTAX

mvr proxy-query-interval *interval*

no mvr proxy-query-interval

interval - The interval at which the receiver port sends out general queries. (Range: 2-31744 seconds)

DEFAULT SETTING

125 seconds

COMMAND MODE

Global Configuration

COMMAND USAGE

This command sets the general query interval at which active receiver ports send out general queries. This interval is only effective when proxy switching is enabled with the [mvr proxy-switching](#) command.

EXAMPLE

This example sets the proxy query interval for MVR proxy switching.

```
Console(config)#mvr proxy-query-interval 250  
Console(config)#
```

mvr proxy-switching This command enables MVR proxy switching, where the source port acts as a host, and the receiver port acts as an MVR router with querier service enabled. Use the **no** form to disable this function.

SYNTAX

[no] mvr proxy-switching

DEFAULT SETTING

Enabled

COMMAND MODE

Global Configuration

COMMAND USAGE

- ◆ When MVR proxy-switching is enabled, an MVR source port serves as the upstream or host interface. The source port performs only the host portion of MVR by sending summarized membership reports, and automatically disables MVR router functions.
- ◆ Receiver ports are known as downstream or router interfaces. These interfaces perform the standard MVR router functions by maintaining a database of all MVR subscriptions on the downstream interface. Receiver ports must therefore be configured on all downstream interfaces which require MVR proxy service.
- ◆ When the source port receives report and leave messages, it only forwards them to other source ports.
- ◆ When receiver ports receive any query messages, they are dropped.
- ◆ When changes occurring in the downstream MVR groups are learned by the receiver ports through report and leave messages, an MVR state change report is created and sent to the upstream source port, which in turn forwards this information upstream.
- ◆ When MVR proxy switching is disabled:
 - Any membership reports received from receiver/source ports are forwarded to all source ports.
 - When a source port receives a query message, it will be forwarded to all downstream receiver ports.
 - When a receiver port receives a query message, it will be dropped.

EXAMPLE

The following example enable MVR proxy switching.

```
Console(config)#mvr proxy-switching
Console(config)#
```

RELATED COMMANDS

[mvr robustness-value \(1287\)](#)

mvr robustness-value This command configures the expected packet loss, and thereby the number of times to generate report and group-specific queries. Use the **no** form to restore the default setting.

SYNTAX

mvr robustness-value *value*

no mvr robustness-value

value - The robustness used for all interfaces. (Range: 1-255)

DEFAULT SETTING

2

COMMAND MODE

Global Configuration

COMMAND USAGE

- ◆ This command is used to set the number of times report messages are sent upstream when changes are learned about downstream groups, and the number of times group-specific queries are sent to downstream receiver ports.
- ◆ This command only takes effect when MVR proxy switching is enabled.

EXAMPLE

```
Console(config)#mvr robustness-value 5
Console(config)#
```

RELATED COMMANDS

[mvr proxy-switching \(1286\)](#)

mvr source-port-mode dynamic This command configures the switch to only forward multicast streams which the source port has dynamically joined. Use the **no** form to restore the default setting.

SYNTAX

[no] mvr source-port-mode dynamic

DEFAULT SETTING

Forwards all multicast streams which have been specified in a profile and bound to a domain.

COMMAND MODE

Global Configuration

COMMAND USAGE

- ◆ By default, the switch forwards any multicast streams within the address range set by a profile, and bound to a domain. The multicast streams are sent to all source ports on the switch and to all receiver ports that have elected to receive data on that multicast address.
- ◆ When the **mvr source-port-mode dynamic** command is used, the switch only forwards multicast streams which the source port has dynamically joined. In other words, both the receiver port and source port must subscribe to a multicast group before a multicast stream is forwarded to any attached client. Note that the requested streams are still restricted to the address range which has been specified in a profile and bound to a domain.

EXAMPLE

```
Console(config)#mvr source-port-mode dynamic
Console(config)#
```

mvr upstream-source-ip This command configures the source IP address assigned to all MVR control packets sent upstream on all domains or on a specified domain. Use the **no** form to restore the default setting.

SYNTAX

mvr [domain *domain-id*] upstream-source-ip *source-ip-address*

no mvr [domain *domain-id*] upstream-source-ip

domain-id - An independent multicast domain. (Range: 1-5)

source-ip-address - The source IPv4 address assigned to all MVR control packets sent upstream.

DEFAULT SETTING

All MVR reports sent upstream use a null source IP address

COMMAND MODE

Global Configuration

EXAMPLE

```
Console(config)#mvr domain 1 upstream-source-ip 192.168.0.3
Console(config)#
```

mvr vlan This command specifies the VLAN through which MVR multicast data is received. Use the **no** form of this command to restore the default MVR VLAN.

SYNTAX

mvr [**domain** *domain-id*] **vlan** *vlan-id*

no mvr [**domain** *domain-id*] **vlan**

domain-id - An independent multicast domain. (Range: 1-5)

vlan-id - Specifies the VLAN through which MVR multicast data is received. This is also the VLAN to which all source ports must be assigned. (Range: 1-4094)

DEFAULT SETTING

VLAN 1

COMMAND MODE

Global Configuration

COMMAND USAGE

- ◆ This command specifies the VLAN through which MVR multicast data is received. This is the VLAN to which all source ports must be assigned.
- ◆ The VLAN specified by this command must be an existing VLAN configured with the [vlan](#) command.
- ◆ MVR source ports can be configured as members of the MVR VLAN using the [switchport allowed vlan](#) command and [switchport native vlan](#) command, but MVR receiver ports should not be statically configured as members of this VLAN.

EXAMPLE

The following example sets the MVR VLAN to VLAN 2:

```
Console(config)#mvr
Console(config)#mvr domain 1 vlan 2
Console(config)#
```

mvr immediate-leave This command causes the switch to immediately remove an interface from a multicast stream as soon as it receives a leave message for that group. Use the **no** form to restore the default settings.

SYNTAX

[no] mvr [domain *domain-id*] immediate-leave [by-host-ip]

domain-id - An independent multicast domain. (Range: 1-5)

by-host-ip - Specifies that the member port will be deleted only when there are no hosts joining this group.

DEFAULT SETTING

Disabled

COMMAND MODE

Interface Configuration (Ethernet, Port Channel)

COMMAND USAGE

- ◆ Immediate leave applies only to receiver ports. When enabled, the receiver port is immediately removed from the multicast group identified in the leave message. When immediate leave is disabled, the switch follows the standard rules by sending a group-specific query to the receiver port and waiting for a response to determine if there are any remaining subscribers for that multicast group before removing the port from the group list.
- ◆ If the "by-host-ip" option is used, the router/querier will not send out a group-specific query when an IGMPv2/v3 leave message is received (the same as it would without this option having been used). Instead of immediately deleting that group, it will look up the record, and only delete the group if there are no other subscribers for it on the member port. Only when all hosts on that port leave the group will the member port be deleted.
- ◆ Using immediate leave can speed up leave latency, but should only be enabled on a port attached to only one multicast subscriber to avoid disrupting services to other group members attached to the same interface.
- ◆ Immediate leave does not apply to multicast groups which have been statically assigned to a port with the **mvr vlan group** command.

EXAMPLE

The following enables immediate leave on a receiver port.

```
Console(config)#interface ethernet 1/5
Console(config-if)#mvr domain 1 immediate-leave
Console(config-if)#
```

mvr type This command configures an interface as an MVR receiver or source port. Use the **no** form to restore the default settings.

SYNTAX

[no] mvr [domain *domain-id*] type {receiver | source}

domain-id - An independent multicast domain. (Range: 1-5)

receiver - Configures the interface as a subscriber port that can receive multicast data.

source - Configures the interface as an uplink port that can send and receive multicast data for the configured multicast groups.

DEFAULT SETTING

The port type is not defined.

COMMAND MODE

Interface Configuration (Ethernet, Port Channel)

COMMAND USAGE

- ◆ A port which is not configured as an MVR receiver or source port can use IGMP snooping to join or leave multicast groups using the standard rules for multicast filtering.
- ◆ Receiver ports can belong to different VLANs, but should not normally be configured as a member of the MVR VLAN. IGMP snooping can also be used to allow a receiver port to dynamically join or leave multicast groups not sourced through the MVR VLAN. Also, note that VLAN membership for MVR receiver ports cannot be set to access mode (see the [switchport mode](#) command).
- ◆ One or more interfaces may be configured as MVR source ports. A source port is able to both receive and send data for multicast groups which it has joined through the MVR protocol or which have been assigned through the [mvr vlan group](#) command.
- ◆ Only IGMP version 2 or 3 hosts can issue multicast join or leave messages. If MVR must be configured for an IGMP version 1 host, the multicast groups must be statically assigned using the [mvr vlan group](#) command.

EXAMPLE

The following configures one source port and several receiver ports on the switch.

```

Console(config)#interface ethernet 1/5
Console(config-if)#mvr domain 1 type source
Console(config-if)#exit
Console(config)#interface ethernet 1/6
Console(config-if)#mvr domain 1 type receiver
Console(config-if)#exit
Console(config)#interface ethernet 1/7
Console(config-if)#mvr domain 1 type receiver

```

mvr vlan group This command statically binds a multicast group to a port which will receive long-term multicast streams associated with a stable set of hosts. Use the **no** form to restore the default settings.

SYNTAX

[no] mvr [domain *domain-id*] vlan *vlan-id* group *ip-address*

domain-id - An independent multicast domain. (Range: 1-5)

vlan-id - Receiver VLAN to which the specified multicast traffic is flooded. (Range: 1-4094)

group - Defines a multicast service sent to the selected port.

ip-address - Statically configures an interface to receive multicast traffic from the IPv4 address specified for an MVR multicast group. (Range: 224.0.1.0 - 239.255.255.255)

DEFAULT SETTING

No receiver port is a member of any configured multicast group.

COMMAND MODE

Interface Configuration (Ethernet, Port Channel)

COMMAND USAGE

- ◆ Multicast groups can be statically assigned to a receiver port using this command.
- ◆ The IP address range from 224.0.0.0 to 239.255.255.255 is used for multicast streams. MVR group addresses cannot fall within the reserved IP multicast address range of 224.0.0.x.
- ◆ Only IGMP version 2 or 3 hosts can issue multicast join or leave messages. If MVR must be configured for an IGMP version 1 host, the multicast groups must be statically assigned using the **mvr vlan group** command.
- ◆ The MVR VLAN cannot be specified as the receiver VLAN for static bindings.

EXAMPLE

The following statically assigns a multicast group to a receiver port:

```
Console(config)#interface ethernet 1/7
Console(config-if)#mvr domain 1 type receiver
Console(config-if)#mvr domain 1 vlan 3 group 225.0.0.5
Console(config-if)#
```

clear mrv groups dynamic This command clears multicast group information dynamically learned through MRV.

SYNTAX

clear mrv groups dynamic

COMMAND MODE

Privileged Exec

COMMAND USAGE

This command only clears entries learned through MRV. Statically configured multicast addresses are not cleared.

Example

```
Console#clear mrv groups dynamic
Console#
```

clear mrv statistics This command clears MRV statistics.

SYNTAX

clear mrv statistics [**interface** *interface*]

interface

ethernet *unit/port*

unit - Unit identifier. (Range: 1)

port - Port number. (Range: 1-28/52)

port-channel *channel-id* (Range: 1-16)

vlan *vlan-id* - VLAN identifier (Range: 1-4094)

COMMAND MODE

Privileged Exec

EXAMPLE

```
Console#clear ip igmp snooping statistics
Console#
```

show mvr This command shows information about MVR domain settings, including MVR operational status, the multicast VLAN, the current number of group addresses, and the upstream source IP address.

SYNTAX

show mvr [**domain** *domain-id*]

domain-id - An independent multicast domain. (Range: 1-5)

DEFAULT SETTING

Displays configuration settings for all MVR domains.

COMMAND MODE

Privileged Exec

EXAMPLE

The following shows the MVR settings:

```

Console#show mvr
MVR 802.1p Forwarding Priority : Disabled
MVR Proxy Switching           : Enabled
MVR Robustness Value          : 1
MVR Proxy Query Interval      : 125(sec.)
MVR Source Port Mode          : Always Forward

MVR Domain                    : 1
MVR Config Status             : Enabled
MVR Running Status            : Active
MVR Multicast VLAN            : 1
MVR Current Learned Groups    : 10
MVR Upstream Source IP        : 192.168.0.3
:
```

Table 174: show mvr - display description

Field	Description
MVR 802.1p Forwarding Priority	Priority assigned to multicast traffic forwarded into the MVR VLAN
MVR Proxy Switching	Shows if MVR proxy switching is enabled
MVR Robustness Value	Shows the number of reports or query messages sent when proxy switching is enabled
MVR Proxy Query Interval	The interval at which the receiver port sends out general queries
MVR Source Port Mode	Shows if the switch only forwards multicast streams which the source port has dynamically joined or always forwards multicast streams
MVR Domain	An independent multicast domain.
MVR Config Status	Shows if MVR is globally enabled on the switch.
MVR Running Status	Indicates whether or not all necessary conditions in the MVR environment are satisfied. (Running status is true as long as MVR Status is enabled, and the specified MVR VLAN exists.)
MVR Multicast VLAN	Shows the VLAN used to transport all MVR multicast traffic.
MVR Current Learned Groups	The current number of MVR group addresses
MVR Upstream Source IP	The source IP address assigned to all upstream control packets.

show mvr associated-profile This command shows the profiles bound the specified domain.

SYNTAX

show mvr [domain *domain-id*] associated-profile

domain-id - An independent multicast domain. (Range: 1-5)

DEFAULT SETTING

Displays profiles bound to all MVR domains.

COMMAND MODE

Privileged Exec

EXAMPLE

The following displays the profiles bound to domain 1:

```

Console#show mvr domain 1 associated-profile
Domain ID : 1
MVR Profile Name      Start IP Addr.  End IP Addr.
-----
rd                    228.1.23.1     228.1.23.10
testing               228.2.23.1     228.2.23.10
Console#
    
```

show mvr interface This command shows MVR configuration settings for interfaces attached to the MVR VLAN.

SYNTAX

show mvr [domain *domain-id*] interface

domain-id - An independent multicast domain. (Range: 1-5)

DEFAULT SETTING

Displays configuration settings for all attached interfaces.

COMMAND MODE

Privileged Exec

EXAMPLE

The following displays information about the interfaces attached to the MVR VLAN in domain 1:

```

Console#show mvr domain 1 interface
MVR Domain : 1
Flag: H - immediate leave by host ip
Port      Type      Status      Immediate  Static Group Address
-----
Eth 1/ 1 Source  Active/Forwarding
Eth 1/ 2 Receiver Inactive/Discarding  Disabled  234.5.6.8 (VLAN2)
Eth 1/ 3 Source  Inactive/Discarding
    
```

```

Eth 1/ 1 Receiver Active/Forwarding      Disabled  225.0.0.1 (VLAN1)
                                           225.0.0.9 (VLAN3)
Eth1/ 4 Receiver Active/Discarding      Disabled
Console#

```

Table 175: show mvr interface - display description

Field	Description
MVR Domain	An independent multicast domain.
Port	Shows interfaces attached to the MVR.
Type	Shows the MVR port type.
Status	Shows the MVR status and interface status. MVR status for source ports is "ACTIVE" if MVR is globally enabled on the switch. MVR status for receiver ports is "ACTIVE" only if there are subscribers receiving multicast traffic from one of the MVR groups, or a multicast group has been statically assigned to an interface. Also shows if MVR traffic is being forwarded or discarded.
Immediate	Shows if immediate leave is enabled or disabled.
Static Group Address	Shows any static MVR group assigned to an interface, and the receiver VLAN.

show mvr members This command shows information about the current number of entries in the forwarding database, detailed information about a specific multicast address, the IP address of the hosts subscribing to all active multicast groups, or the multicast groups associated with each port.

SYNTAX

show mvr [**domain** *domain-id*] **members** [*ip-address* | **host-ip-address** [*interface*] | **igmp** | **sort-by-port** [*interface*] | **unknown** | **user**]

domain-id - An independent multicast domain. (Range: 1-5)

ip-address - IPv4 address for an MVR multicast group. (Range: 224.0.1.0 - 239.255.255.255)

members - The multicast groups assigned to the MVR VLAN.

host-ip-address - The subscriber IP addresses.

igmp - Entry created by IGMP protocol.

sort-by-port - The multicast groups associated with an interface.

interface

ethernet *unit/port*

unit - Unit identifier. (Range: 1)

port - Port number. (Range: 1-28/52)

port-channel *channel-id* (Range: 1-16)

unknown - Entry created by receiving a multicast stream.

user - Snooping entry learned from user's configuration settings.

DEFAULT SETTING

Displays configuration settings for all domains and all forwarding entries.

COMMAND MODE

Privileged Exec

EXAMPLE

The following shows information about the number of multicast forwarding entries currently active in domain 1:

```

Console#show mvr domain 1 members
MVR Domain : 1
MVR Forwarding Entry Count :1
Flag: S - Source port, R - Receiver port.
      H - Host counts (number of hosts joined to group on this port).
      P - Port counts (number of ports joined to group).
Up time: Group elapsed time (d:h:m:s).
Expire : Group remaining time (m:s).

Group Address  VLAN Port          Up time      Expire Count
-----
234.5.6.7      1                  00:00:09:17      2 (P)
                1 Eth 1/ 1(S)
                2 Eth 1/ 2(R)

Console#

```

The following example shows detailed information about a specific multicast address:

```

Console#show mvr domain 1 members 234.5.6.7
MVR Domain : 1
MVR Forwarding Entry Count :1
Flag: S - Source port, R - Receiver port.
      H - Host counts (number of hosts joined to group on this port).
      P - Port counts (number of ports joined to group).
Up time: Group elapsed time (d:h:m:s).
Expire : Group remaining time (m:s).

Group Address  VLAN Port          Up time      Expire Count
-----
234.5.6.7      1                  00:00:09:17      2 (P)
                1 Eth 1/ 1(S)
                2 Eth 1/ 2(R)

Console#

```

Table 176: show mvr members - display description

Field	Description
Group Address	Multicast group address.
VLAN	VLAN to which this address is forwarded.
Port	Port to which this address is forwarded.
Uptime	Time that this multicast group has been known.

Table 176: show mvr members - display description (Continued)

Field	Description
Expire	The time until this entry expires.
Count	The number of times this address has been learned by IGMP snooping.

show mvr profile This command shows all configured MVR profiles.

COMMAND MODE
Privileged Exec

EXAMPLE
The following shows all configured MVR profiles:

```

Console#show mvr profile
MVR Profile Name      Start IP Addr.  End IP Addr.
-----
rd                    228.1.23.1     228.1.23.10
testing               228.2.23.1     228.2.23.10
Console#

```

show mvr statistics This command shows MVR protocol-related statistics for the specified interface.

SYNTAX

show mvr [domain *domain-id*] statistics
input [interface *interface*] | output [interface *interface*] |
query | summary interface [*interface* | mvr-vlan]

domain-id - An independent multicast domain. (Range: 1-5)

interface

ethernet *unit/port*

unit - Unit identifier. (Range: 1)

port - Port number. (Range: 1-28/52)

port-channel *channel-id* (Range: 1-16)

vlan *vlan-id* - VLAN ID (Range: 1-4094)

query - Displays MVR query-related statistics.

summary - Displays summary of MVR statistics.

mvr vlan - Displays summary statistics for the MVR VLAN.

DEFAULT SETTING

Displays statistics for all domains.

COMMAND MODE
Privileged Exec

EXAMPLE

The following shows MVR protocol-related statistics received:

```

Console#show mvr domain 1 statistics input
MVR Domain : 1 , MVR VLAN: 2
Input Statistics:
Interface Report   Leave   G Query  G(-S)-S Query Drop   Join Succ Group
-----
Eth 1/ 1          23      11       4          10     5       20     9
Eth 1/ 2          12      15       8           3     5       19     4
DVLAN  1           2       0         0           2     2       20     9
MVLAN  1           2       0         0           2     2       20     9
Console#

```

Table 177: show mvr statistics input - display description

Field	Description
Interface	Shows interfaces attached to the MVR.
Report	The number of IGMP membership reports received on this interface.
Leave	The number of leave messages received on this interface.
G Query	The number of general query messages received on this interface.
G(-S)-S Query	The number of group specific or group-and-source specific query messages received on this interface.
Drop	The number of times a report, leave or query was dropped. Packets may be dropped due to invalid format, rate limiting, packet content not allowed, or MVR group report received
Join Succ	The number of times a multicast group was successfully joined.
Group	The number of MVR groups active on this interface.

The following shows MVR protocol-related statistics sent:

```

Console#show mvr domain 1 statistics output
MVR Domain : 1 , MVR VLAN: 2
Output Statistics:
Interface Report   Leave   G Query  G(-S)-S Query
-----
Eth 1/ 1          12       0         1           0
Eth 1/ 2           5       1         4           1
DVLAN  1           7       2         3           0
MVLAN  1           7       2         3           0
Console#

```

Table 178: show mvr statistics output - display description

Field	Description
Interface	Shows interfaces attached to the MVR.
Report	The number of IGMP membership reports sent from this interface.
Leave	The number of leave messages sent from this interface.
G Query	The number of general query messages sent from this interface.
G(-S)-S Query	The number of group specific or group-and-source specific query messages sent from this interface.

The following shows MVR query-related statistics:

```

Console#show mvr domain 1 statistics query
Domain 1:
  Other Querier           : None
  Other Querier Expire    : 0 (m) :0 (s)
  Other Querier Uptime    : 0 (h) :0 (m) :0 (s)
  Self Querier            : None
  Self Querier Expire     : 0 (m) :30 (s)
  Self Querier Uptime     : 0 (h) :9 (m) :55 (s)
  General Query Received  : 0
  General Query Sent      : 8
  Specific Query Received : 0
  Specific Query Sent     : 3
  Warn Rate Limit        : 0 sec.
  V1 Warning Count       : 0
  V2 Warning Count       : 0
  V3 Warning Count       : 0
Console#

```

Table 179: show mvr statistics query - display description

Field	Description
Other Querier	The IP address of the querier on this interface.
Other Querier Expire	The time after which this querier is assumed to have expired.
Other Querier Uptime	Other querier's time up.
Self Querier	This querier's IP address.
Self Querier Expire	This querier's expire time.
Self Querier Uptime	This querier's time up.
General Query Received	The number of general queries received on this interface.
General Query Sent	The number of general queries sent from this interface.
Specific Query Received	The number of specific queries received on this interface.
Specific Query Sent	The number of specific queries sent from this interface.
Warn Rate Limit	Count down from 15 seconds after receiving a Query different from the configured version.
V# Warning Count	Number of queries received on MVR that were configured for IGMP version 1, 2 or 3.

The following shows MVR summary statistics for an interface:

```

Console#show mvr domain 1 statistics summary interface ethernet 1/1
Domain 1:
Number of Groups: 0
Querier:          :          Report & Leave:  :
  Transmit       :          Transmit       :
    General      : 0          Report       : 7
    Group Specific : 0          Leave        : 4
Received        :          Received        :
  General       : 0          Report       : 0
  Group Specific : 0          Leave        : 0
  V1 Warning Count: 0          Join Success  : 0
  V2 Warning Count: 0          Filter Drop   : 0
  V3 Warning Count: 0
                                     Source Port Drop: 0
                                     Others Drop    : 0

Console#

```

Table 180: show mvr statistics summary interface - display description

Field	Description
Domain	An independent multicast domain.
Number of Groups	Number of groups learned on this port.
Querier	
Transmit	
General	Number of general queries transmitted.
Group Specific	Number of group specific queries transmitted.
Received	
General	Number of general queries received.
Group Specific	Number of group specific queries received.
V# Warning Count	Number of queries received on MVR that were configured for IGMP version 1, 2 or 3.
Report & Leave	
Transmit	
Report	Number of transmitted reports.
Leave	Number of transmitted leaves.
Received	
Report	Number of reports received.
Leave	Number of leaves received.
Join Success	Number of join reports processed successfully.
Filter Drop	Number of report/leave messages dropped by IGMP filter.
Source Port Drop	Number of report/leave messages dropped by MVR source port.
Others Drop	Number of report/leave messages dropped for other reasons.

The following shows MVR summary statistics for the MVR VLAN:

```

Console#show mvr domain 1 statistics summary interface mvr-vlan
Domain 1:
Number of Groups: 0
Querier: : Report & Leave: :
  Other Querier : None Host IP Addr : 192.168.0.66
  Other Expire : 0(m):0(s) Unsolicit Expire : 5(m):4(s)
  Other Uptime : 0(h):0(m):0(s)
  Self Querier : None
  Self Expire : 1(m):45(s) :
  Self Uptime : 0(h):14(m):54(s)
Transmit : Transmit :
  General : 11 Report : 7
  Group Specific : 3 Leave : 4
Received : Received :
  General : 0 Report : 6
  Group Specific : 0 Leave : 0
  V1 Warning Count: 0 Join Success : 6
  V2 Warning Count: 0 Filter Drop : 0
  V3 Warning Count: 0
Source Port Drop: 0
Others Drop : 0

Console#

```

Table 181: show mvr statistics summary interface mvr vlan - description

Field	Description
Domain	An independent multicast domain.
Number of Groups	Number of groups learned on this port.
Querier	
Other Querier	Other IGMP querier's IP address.
Other Expire	Other querier's expire time.
Other Uptime	Other querier's time up.
Self Querier	This querier's IP address.
Self Expire	This querier's expire time.
Self Uptime	This querier's time up.
Transmit	
General	Number of general queries sent from receiver port.
Group Specific	Number of group specific queries sent from receiver port.
Received	
General	Number of general queries received.
Group Specific	Number of group specific queries received.
V# Warning Count	Number of queries received on MVR that were configured by IGMP version 1, 2 or 3.
Report & Leave	
Host IP Addr	Source IP address used to send report/leave messages from source port.
Unsolicit Expire	Expiration time for unsolicit reports sent out from source port

Table 181: show mvr statistics summary interface mvr vlan - description

Field	Description
Transmit	
Report	Number of reports sent out from source port.
Leave	Number of leaves sent out from source port.
Received	Field header
Report	Number of reports received.
Leave	Number of leaves received.
Join Success	Number of join reports processed successfully.
Filter Drop	Number of report/leave messages dropped by IGMP filter.
Source Port Drop	Number of report/leave messages dropped by MVR source port.
Others Drop	Number of report/leave messages dropped for other reasons.

MVR FOR IPv6

This section describes commands used to configure Multicast VLAN Registration for IPv6 (MVR6). A single network-wide VLAN can be used to transmit multicast traffic (such as television channels) across a service provider’s network. Any multicast traffic entering an MVR VLAN is sent to all subscribers. This can significantly reduce to processing overhead required to dynamically monitor and establish the distribution tree for a normal multicast VLAN. Also note that MVR maintains the user isolation and data security provided by VLAN segregation by passing only multicast traffic into other VLANs to which the subscribers belong.

Table 182: Multicast VLAN Registration for IPv6 Commands

Command	Function	Mode
<code>mvr6 associated-profile</code>	Binds the MVR group addresses specified in a profile to an MVR domain	GC
<code>mvr6 domain</code>	Enables MVR for a specific domain	GC
<code>mvr6 priority</code>	Assigns a priority to all multicast traffic in the MVR VLAN	GC
<code>mvr6 profile</code>	Maps a range of MVR group addresses to a profile	GC
<code>mvr6 proxy-query-interval</code>	Configures the interval at which the receiver port sends out general queries.	GC
<code>mvr6 proxy-switching</code>	Enables MVR proxy switching, where the source port acts as a host, and the receiver port acts as an MVR router with querier service enabled	GC
<code>mvr6 robustness-value</code>	Configures the expected packet loss, and thereby the number of times to generate report and group-specific queries	GC
<code>mvr6 source-port-mode dynamic</code>	Configures the switch to only forward multicast streams which the source port has dynamically joined	GC
<code>mvr6 upstream-source-ip</code>	Configures the source IP address assigned to all control packets sent upstream	GC

Table 182: Multicast VLAN Registration for IPv6 Commands (Continued)

Command	Function	Mode
<code>mvr6 vlan</code>	Specifies the VLAN through which MVR multicast data is received	GC
<code>mvr6 immediate-leave</code>	Enables immediate leave capability	IC
<code>mvr6 type</code>	Configures an interface as an MVR receiver or source port	IC
<code>mvr6 vlan group</code>	Statically binds a multicast group to a port	IC
<code>clear mvr6 groups dynamic</code>	Clears multicast group information dynamically learned through MVR6	PE
<code>clear mvr6 statistics</code>	Clears the MVR statistics globally or on a per-interface basis.	PE
<code>show mvr6</code>	Shows information about MVR domain settings, including MVR operational status, the multicast VLAN, the current number of group addresses, and the upstream source IP address	PE
<code>show mvr6 associated-profile</code>	Shows the profiles bound the specified domain	PE
<code>show mvr6 interface</code>	Shows MVR settings for interfaces attached to the MVR VLAN	PE
<code>show mvr6 members</code>	Shows information about the current number of entries in the forwarding database, or detailed information about a specific multicast address	PE
<code>show mvr6 profile</code>	Shows all configured MVR profiles	PE
<code>show mvr6 statistics</code>	Shows MVR protocol statistics for the specified interface	PE

mvr6 associated-profile This command binds the MVR group addresses specified in a profile to an MVR domain. Use the **no** form of this command to remove the binding.

SYNTAX

[no] mvr6 domain *domain-id* associated-profile *profile-name*

domain-id - An independent multicast domain. (Range: 1-5)

profile-name - The name of a profile containing one or more MVR group addresses. (Range: 1-21 characters)

DEFAULT SETTING

Disabled

COMMAND MODE

Global Configuration

COMMAND USAGE

MVR6 domains can be associated with more than one MVR6 profile. But since MVR6 domains cannot share the group range, an MVR6 profile can only be associated with one MVR6 domain.

EXAMPLE

The following an MVR6 group address profile to domain 1:

```
Console(config)#mvr6 domain 1 associated-profile rd
Console(config)#
```

mvr6 domain This command enables Multicast VLAN Registration (MVR) for a specific domain. Use the **no** form of this command to disable MVR for a domain.

SYNTAX

[no] mvr6 domain *domain-id*

domain-id - An independent multicast domain. (Range: 1-5)

DEFAULT SETTING

Disabled

COMMAND MODE

Global Configuration

COMMAND USAGE

When MVR6 is enabled on a domain, any multicast data associated with an MVR6 group is sent from all designated source ports, to all receiver ports that have registered to receive data from that multicast group.

EXAMPLE

The following example enables MVR6 for domain 1:

```
Console(config)#mvr6 domain 1
Console(config)#
```

mvr6 priority This command assigns a priority to all multicast traffic in the MVR6 VLAN. Use the **no** form of this command to restore the default setting.

SYNTAX

mvr6 priority *priority*

no mvr6 priority

priority - The CoS priority assigned to all multicast traffic forwarded into the MVR6 VLAN. (Range: 0-7, where 7 is the highest priority)

DEFAULT SETTING

Disabled

COMMAND MODE

Global Configuration

COMMAND USAGE

This command can be used to set a high priority for low-latency multicast traffic such as a video-conference, or to set a low priority for normal multicast traffic not sensitive to latency.

EXAMPLE

```
Console(config)#mvr6 priority 6  
Console(config)#
```

RELATED COMMANDS

[show mvr6](#)

mvr6 profile This command maps a range of MVR group addresses to a profile. Use the **no** form of this command to remove the profile.

SYNTAX

mvr6 profile *profile-name start-ip-address end-ip-address*

profile-name - The name of a profile containing one or more MVR group addresses. (Range: 1-21 characters)

start-ip-address - Starting IPv6 address for an MVR multicast group. This parameter must be a full IPv6 address including the network prefix and host address bits.

end-ip-address - Ending IPv6 address for an MVR multicast group. This parameter must be a full IPv6 address including the network prefix and host address bits.

DEFAULT SETTING

No profiles are defined

COMMAND MODE

Global Configuration

COMMAND USAGE

- ◆ Use this command to statically configure all multicast group addresses that will join the MVR VLAN. Any multicast data associated with an MVR group is sent from all source ports, and to all receiver ports that have registered to receive data from that multicast group.
- ◆ IGMP snooping and MVR share a maximum number of 1023 groups. Any multicast streams received in excess of this limitation will be flooded to all ports in the associated domain.
- ◆ All IPv6 addresses must be according to RFC 2373 "IPv6 Addressing Architecture," using 8 colon-separated 16-bit hexadecimal values. One double colon may be used in the address to indicate the appropriate number of zeros required to fill the undefined fields. (Note that the IP address ff02::X is reserved.)

- ◆ The MVR6 group address range assigned to a profile cannot overlap with the group address range of any other profile.

EXAMPLE

The following example maps a range of MVR6 group addresses to a profile:

```
Console(config)#mvr6 profile rd ff01:0:0:0:0:0:fe ff01:0:0:0:0:0:ff
Console(config)#
```

mvr6 proxy-query-interval This command configures the interval at which the receiver port sends out general queries. Use the **no** form to restore the default setting.

SYNTAX

mvr proxy-query-interval *interval*

no mvr proxy-query-interval

interval - The interval at which the receiver port sends out general queries. (Range: 2-31744 seconds)

DEFAULT SETTING

125 seconds

COMMAND MODE

Global Configuration

COMMAND USAGE

This command sets the general query interval at which active receiver ports send out general queries. This interval is only effective when proxy switching is enabled with the [mvr6 proxy-switching](#) command.

EXAMPLE

This example sets the proxy query interval for MVR6.

```
Console(config)#mvr6 proxy-query-interval 1000
Console(config)#
```

mvr6 proxy-switching This command enables MVR proxy switching, where the source port acts as a host, and the receiver port acts as an MVR router with querier service enabled. Use the **no** form to disable this function.

SYNTAX

[no] mvr6 proxy-switching

DEFAULT SETTING

Enabled

COMMAND MODE

Global Configuration

COMMAND USAGE

- ◆ When MVR proxy-switching is enabled, an MVR source port serves as the upstream or host interface, and the MVR receiver port serves as the querier. The source port performs only the host portion of MVR by sending summarized membership reports, and automatically disables MVR router functions.
- ◆ Receiver ports are known as downstream or router interfaces. These interfaces perform the standard MVR router functions by maintaining a database of all MVR subscriptions on the downstream interface. Receiver ports must therefore be configured on all downstream interfaces which require MVR proxy service.
- ◆ When the source port receives report and leave messages, it only forwards them to other source ports.
- ◆ When receiver ports receive any query messages, they are dropped.
- ◆ When changes occurring in the downstream MVR groups are learned by the receiver ports through report and leave messages, an MVR state change report is created and sent to the upstream source port, which in turn forwards this information upstream.
- ◆ When MVR proxy switching is disabled:
 - Any membership reports received from receiver/source ports are forwarded to all source ports.
 - When a source port receives a query message, it will be forwarded to all downstream receiver ports.
 - When a receiver port receives a query message, it will be dropped.

EXAMPLE

The following example enable MVR6 proxy switching.

```
Console(config)#mvr6 proxy-switching  
Console(config)#
```

RELATED COMMANDS

[mvr6 robustness-value \(1309\)](#)

mvr6 robustness-value This command configures the expected packet loss, and thereby the number of times to generate report and group-specific queries. Use the **no** form to restore the default setting.

SYNTAX

mvr6 robustness-value *value*

no mvr6 robustness-value

value - The robustness used for all interfaces. (Range: 1-10)

DEFAULT SETTING

2

COMMAND MODE

Global Configuration

COMMAND USAGE

- ◆ This command sets the number of times report messages are sent upstream when changes are learned about downstream groups, and the number of times group-specific queries are sent to downstream receiver ports.
- ◆ This command only takes effect when MVR6 proxy switching is enabled.

EXAMPLE

```
Console(config)#mvr6 robustness-value 5
Console(config)#
```

RELATED COMMANDS

[mvr6 proxy-switching \(1307\)](#)

mvr6 source-port-mode dynamic This command configures the switch to only forward multicast streams which the source port has dynamically joined. Use the **no** form to restore the default setting.

SYNTAX

[no] mvr6 source-port-mode dynamic

DEFAULT SETTING

Forwards all multicast streams which have been specified in a profile and bound to a domain.

COMMAND MODE

Global Configuration

COMMAND USAGE

- ◆ By default, the switch forwards any multicast streams within the address range set by a profile, and bound to a domain. The multicast

streams are sent to all source ports on the switch and to all receiver ports that have elected to receive data on that multicast address.

- ◆ When the **mvr6 source-port-mode dynamic** command is used, the switch only forwards multicast streams which the source port has dynamically joined. In other words, both the receiver port and source port must subscribe to a multicast group before a multicast stream is forwarded to any attached client. Note that the requested streams are still restricted to the address range which has been specified in a profile and bound to a domain.

EXAMPLE

```
Console(config)#mvr6 source-port-mode dynamic
Console(config)#
```

mvr6 upstream-source-ip

This command configures the source IPv6 address assigned to all MVR control packets sent upstream on the specified domain. Use the **no** form to restore the default setting.

SYNTAX

mvr6 domain *domain-id* **upstream-source-ip** *source-ip-address*

no mvr6 domain *domain-id* **upstream-source-ip**

domain-id - An independent multicast domain. (Range: 1-5)

source-ip-address - The source IPv6 address assigned to all MVR control packets sent upstream. This parameter must be a full IPv6 address including the network prefix and host address bits.

DEFAULT SETTING

All MVR reports sent upstream use a null source IP address

COMMAND MODE

Global Configuration

COMMAND USAGE

All IPv6 addresses must be according to RFC 2373 "IPv6 Addressing Architecture," using 8 colon-separated 16-bit hexadecimal values. One double colon may be used in the address to indicate the appropriate number of zeros required to fill the undefined fields. (Note that the IP address ff02::X is reserved.)

EXAMPLE

```
Console(config)#mvr6 domain 1 upstream-source-ip 2001:DB8:2222:7223::72
Console(config)#
```

mvr6 vlan This command specifies the VLAN through which MVR multicast data is received. Use the **no** form of this command to restore the default MVR VLAN.

SYNTAX

mvr6 domain *domain-id* **vlan** *vlan-id*

no mvr6 domain *domain-id* **vlan**

domain-id - An independent multicast domain. (Range: 1-5)

vlan-id - Specifies the VLAN through which MVR multicast data is received. This is also the VLAN to which all source ports must be assigned. (Range: 1-4094)

DEFAULT SETTING

VLAN 1

COMMAND MODE

Global Configuration

COMMAND USAGE

MVR source ports can be configured as members of the MVR VLAN using the [switchport allowed vlan](#) command and [switchport native vlan](#) command, but MVR receiver ports should not be statically configured as members of this VLAN.

EXAMPLE

The following example sets the MVR6 VLAN to VLAN 1:

```
Console(config)#mvr6 domain 1 vlan 1
Console(config)#
```

mvr6 immediate-leave This command causes the switch to immediately remove an interface from a multicast stream as soon as it receives a leave message for that group. Use the **no** form to restore the default settings.

SYNTAX

[**no**] **mvr6 domain** *domain-id* **immediate-leave** [**by-host-ip**]

domain-id - An independent multicast domain. (Range: 1-5)

by-host-ip - Specifies that the member port will be deleted only when there are no hosts joining this group.

DEFAULT SETTING

Disabled

COMMAND MODE

Interface Configuration (Ethernet, Port Channel)

COMMAND USAGE

- ◆ Immediate leave applies only to receiver ports. When enabled, the receiver port is immediately removed from the multicast group identified in the leave message. When immediate leave is disabled, the switch follows the standard rules by sending a group-specific query to the receiver port and waiting for a response to determine if there are any remaining subscribers for that multicast group before removing the port from the group list.
- ◆ If the “by-host-ip” option is used, the router/querier will not send out a group-specific query when an MLDv1/v2 Listener Done message is received (the same as it would without this option having been used). Instead of immediately deleting that group, it will look up the record, and only delete the group if there are no other subscribers for it on the member port. Only when all hosts on that port leave the group will the member port be deleted.
- ◆ Using immediate leave can speed up leave latency, but should only be enabled on a port attached to only one multicast subscriber to avoid disrupting services to other group members attached to the same interface.
- ◆ Immediate leave does not apply to multicast groups which have been statically assigned to a port with the `mvr6 vlan group` command.

EXAMPLE

The following enables immediate leave on a receiver port.

```
Console(config)#interface ethernet 1/5
Console(config-if)#mvr6 domain 1 immediate-leave
Console(config-if)#
```

mvr6 type This command configures an interface as an MVR receiver or source port. Use the **no** form to restore the default settings.

SYNTAX

[no] mvr6 domain *domain-id* type {receiver | source}

domain-id - An independent multicast domain. (Range: 1-5)

receiver - Configures the interface as a subscriber port that can receive multicast data.

source - Configures the interface as an uplink port that can send and receive multicast data for the configured multicast groups. Note that the source port must be manually configured as a member of the MVR6 VLAN using the `switchport allowed vlan` command.

DEFAULT SETTING

The port type is not defined.

COMMAND MODE

Interface Configuration (Ethernet, Port Channel)

COMMAND USAGE

- ◆ A port configured as an MVR6 receiver or source port can join or leave multicast groups configured under MVR6. A port which is not configured as an MVR receiver or source port can use MLD snooping to join or leave multicast groups using the standard rules for multicast filtering (see "[MLD Snooping](#)" on page 1262).
- ◆ Receiver ports can belong to different VLANs, but should not be configured as a member of the MVR VLAN. MLD snooping can be used to allow a receiver port to dynamically join or leave multicast groups not sourced through the MVR VLAN. Also, note that VLAN membership for MVR receiver ports cannot be set to access mode (see the [switchport mode](#) command).
- ◆ One or more interfaces may be configured as MVR source ports. A source port is able to both receive and send data for multicast groups which it has joined through the MVR6 protocol or which have been assigned through the [mvr6 vlan group](#) command.
All source ports must belong to the MVR6 VLAN.
Subscribers should not be directly connected to source ports.
- ◆ The same port cannot be configured as a source port in one MVR domain and as a receiver port in another domain.

EXAMPLE

The following configures one source port and several receiver ports on the switch.

```

Console(config)#interface ethernet 1/5
Console(config-if)#mvr6 domain 1 type source
Console(config-if)#exit
Console(config)#interface ethernet 1/6
Console(config-if)#mvr6 domain 1 type receiver
Console(config-if)#exit
Console(config)#interface ethernet 1/7
Console(config-if)#mvr6 domain 1 type receiver
Console(config-if)#

```

mvr6 vlan group This command statically binds a multicast group to a port which will receive long-term multicast streams associated with a stable set of hosts. Use the **no** form to restore the default settings.

SYNTAX

[no] mvr6 domain *domain-id* **vlan** *vlan-id* **group** *ip-address*

domain-id - An independent multicast domain. (Range: 1-5)

vlan-id - Receiver VLAN to which the specified multicast traffic is flooded. (Range: 1-4094)

group - Defines a multicast service sent to the selected port.

ip-address - Statically configures an interface to receive multicast traffic from the IPv6 address specified for an MVR multicast group. This parameter must be a full IPv6 address including the network prefix and host address bits.

DEFAULT SETTING

No receiver port is a member of any configured multicast group.

COMMAND MODE

Interface Configuration (Ethernet, Port Channel)

COMMAND USAGE

- ◆ Multicast groups can be statically assigned to a receiver port using this command. The assigned address must fall within the range set by the `mvr6 associated-profile` command.
- ◆ All IPv6 addresses must be according to RFC 2373 "IPv6 Addressing Architecture," using 8 colon-separated 16-bit hexadecimal values. One double colon may be used in the address to indicate the appropriate number of zeros required to fill the undefined fields. (Note that the IP address `ff02::X` is reserved.)
- ◆ The MVR VLAN cannot be specified as the receiver VLAN for static bindings.

EXAMPLE

The following statically assigns a multicast group to a receiver port:

```
Console(config)#interface ethernet 1/2
Console(config-if)#mvr6 domain 1 type receiver
Console(config-if)#mvr6 domain 1 vlan 2 group ff00::1
Console(config-if)#
```

clear mvr6 groups dynamic This command clears multicast group information dynamically learned through MVR6.

SYNTAX

clear mvr6 groups dynamic [**domain** *domain-id*]

domain-id - An independent multicast domain. (Range: 1-5)

COMMAND MODE

Privileged Exec

COMMAND USAGE

This command only clears entries learned through MVR6. Statically configured multicast addresses are not cleared.

EXAMPLE

```
Console#clear mvr6 groups dynamic
Console#
```

clear mvr6 statistics Use this command to clear the MVR6 statistics.

SYNTAX

clear mvr6 statistics [**interface** {**ethernet** *unit/port* | **port-channel** *channel-id* | **vlan** *vlan-id*}]

ethernet *unit/port*

unit - Unit identifier. (Range: 1)

port - Port number. (Range: 1-28/52)

port-channel *channel-id* (Range: 1-16)

vlan *vlan-id* (Range: 1-4094)

COMMAND MODE

Privileged Exec

COMMAND USAGE

If the interface option is not used then all MVR6 statistics are cleared. Otherwise using the interface option will only clear the MVR6 statistics of the specified interface.

EXAMPLE

The following shows how to clear all the MVR6 statistics:

```
Console#clear mvr6 statistics
Console#
```

show mvr6 This command shows information about MVR domain settings, including MVR operational status, the multicast VLAN, the current number of group addresses, and the upstream source IP address.

SYNTAX

show mvr6 [**domain** *domain-id*]

domain-id - An independent multicast domain. (Range: 1-5)

DEFAULT SETTING

Displays configuration settings for all MVR domains.

COMMAND MODE

Privileged Exec

EXAMPLE

The following shows the MVR6 settings:

```

Console#show mvr6
MVR6 802.1p Forwarding Priority: Disabled
MVR6 Proxy Switching           : Enabled
MVR6 Robustness Value         : 2
MVR6 Proxy Query Interval     : 125(sec.)
MVR6 Source Port Mode         : Always Forward

Domain                         : 1
MVR6 Config Status           : Enabled
MVR6 Running Status          : Active
MVR6 Multicast VLAN          : 1
MVR6 Current Learned Groups  : 0
MVR6 Upstream Source IP      : FF05::25
Console#
    
```

Table 183: show mvr6 - display description

Field	Description
MVR6 802.1p Forwarding Priority	Priority assigned to multicast traffic forwarded into the MVR6 VLAN
MVR6 Proxy Switching	Shows if MVR proxy switching is enabled
MVR6 Robustness Value	Shows the number of reports or query messages sent when proxy switching is enabled
MVR6 Proxy Query Interval	The interval at which the receiver port sends out general queries
MVR6 Source Port Mode	Shows if the switch only forwards multicast streams which the source port has dynamically joined or always forwards multicast streams
MVR6 Domain	An independent multicast domain.
MVR6 Config Status	Shows if MVR is globally enabled on the switch.
MVR6 Running Status	Indicates whether or not all necessary conditions in the MVR environment are satisfied. (Running status is true as long as MVR Status is enabled, and the specified MVR VLAN exists, and a source port with a valid link has been configured (using the <code>mvr6 type</code> command.)
MVR6 Multicast VLAN	Shows the VLAN used to transport all MVR multicast traffic.
MVR6 Upstream Source IP	The source IP address assigned to all upstream control packets.

show mvr6 associated-profile

This command shows the profiles bound the specified domain.

SYNTAX

show mvr6 [domain *domain-id*] associated-profile

domain-id - An independent multicast domain. (Range: 1-5)

DEFAULT SETTING

Displays profiles bound to all MVR domains.

COMMAND MODE
Privileged Exec

EXAMPLE

The following displays the profiles bound to domain 1:

```

Console#show mvr6 domain 1 associated-profile
Domain ID : 1
MVR Profile Name      Start IPv6 Addr.      End IPv6 Addr.
-----
rd                    ff01::fe              ff01::ff
Console#
    
```

show mvr6 interface This command shows MVR configuration settings for interfaces attached to the MVR VLAN.

SYNTAX

show mvr6 [domain *domain-id*] interface

domain-id - An independent multicast domain. (Range: 1-5)

DEFAULT SETTING

Displays configuration settings for all attached interfaces.

COMMAND MODE

Privileged Exec

EXAMPLE

The following displays information about the interfaces attached to the MVR6 VLAN in domain 1:

```

Console#show mvr6 domain 1 interface
MVR6 Domain : 1
Port      Type      Status              Immediate Leave  Static Group Address
-----
Eth1/ 1   Source   Active/Forwarding
Eth1/ 2   Receiver Active/Forwarding  Disabled         ff00::1 (VLAN2)
Console#
    
```

Table 184: show mvr6 interface - display description

Field	Description
Port	Shows interfaces attached to the MVR.
Type	Shows the MVR port type.
Status	Shows the MVR status and interface status. MVR status for source ports is "ACTIVE" if MVR is globally enabled on the switch. MVR status for receiver ports is "ACTIVE" only if there are subscribers receiving multicast traffic from one of the MVR groups, or a multicast group has been statically assigned to an interface.

Table 184: show mvr6 interface - display description (Continued)

Field	Description
Immediate	Shows if immediate leave is enabled or disabled.
Static Group Address	Shows any static MVR group assigned to an interface, and the receiver VLAN.

show mvr6 members This command shows information about the current number of entries in the forwarding database, or detailed information about a specific multicast address.

SYNTAX

show mvr6 [domain *domain-id*] members [*ip-address*]
domain-id - An independent multicast domain. (Range: 1-5)
ip-address - IPv6 address for an MVR multicast group.

DEFAULT SETTING

Displays configuration settings for all domains and all forwarding entries.

COMMAND MODE

Privileged Exec

EXAMPLE

The following shows information about the number of multicast forwarding entries currently active in domain 1:

```

Console#show mvr6 domain 1 members
MVR6 Domain : 1
MVR6 Forwarding Entry Count :1
Flag: S - Source port, R - Receiver port.
      H - Host counts (number of hosts join the group on this port).
      P - Port counts (number of forwarding ports).
Up time: Group elapsed time (d:h:m:s).
Expire : Group remaining time (m:s).

Group Address          VLAN Port          Up time          Expire Count
-----
ff05::101              2                  00:00:00:19     2(P)
                       2 Eth1/ 2(S)
                       1 Eth1/ 4(R)
                       0(H)

Console#

```

The following example shows detailed information about a specific multicast address:

```

Console#show mvr6 domain 1 members ff00::1
MVR6 Domain : 1
MVR6 Forwarding Entry Count :1
Flag: S - Source port, R - Receiver port.
      H - Host counts (number of hosts join the group on this port).
      P - Port counts (number of forwarding ports).
Up time: Group elapsed time (d:h:m:s).
Expire : Group remaining time (m:s).

Group Address          VLAN Port          Up time          Expire Count
-----
ff05::101              2                  00:00:03:18      2 (P)
                       2 Eth1/ 2(S)
                       1 Eth1/ 4(R)
                                           0 (H)

Console#

```

Table 185: show mvr6 members - display description

Field	Description
Group Address	Multicast group address.
VLAN	VLAN to which this address is forwarded.
Port	Port to which this address is forwarded.
Up time	Time that this multicast group has been known.
Expire	The time until this entry expires.
Count	The number of times this address has been learned by MVR (MLD snooping).

show mvr6 profile This command shows all configured MVR profiles.

COMMAND MODE
Privileged Exec

EXAMPLE
The following shows all configured MVR6 profiles:

```

Console#show mvr6 profile
MVR Profile Name      Start IPv6 Addr.      End IPv6 Addr.
-----
rd                    ff01::fe              ff01::ff
Console#

```

show mvr6 statistics This command shows MVR protocol-related statistics for the specified interface.

SYNTAX

show mvr6 statistics {input | output} [interface interface]

show mvr6 domain domain-id statistics
{input [interface interface] | output [interface interface] | query}

domain-id - An independent multicast domain. (Range: 1-5)

interface

ethernet unit/port

unit - Unit identifier. (Range: 1)

port - Port number. (Range: 1-28/52)

port-channel channel-id (Range: 1-16)

vlan vlan-id - VLAN ID (Range: 1-4094)

query - Displays MVR query-related statistics.

DEFAULT SETTING

Displays statistics for all domains.

COMMAND MODE

Privileged Exec

EXAMPLE

The following shows MVR6 protocol-related statistics received:

```

Console#show mvr6 domain 1 statistics input
MVR6 Domain 1, MVR6 VLAN 2:
Input Statistics:
Interface Report    Leave    G Query  G(-S)-S Query Drop    Join Succ Group
-----
Eth 1/ 1           23       11       4         10       5       20       9
Eth 1/ 2           12       15       8          3         5       19       4
DVLAN 1            2         0         0          2         2       20       9
MVLAN 2            2         0         0          2         2       20       9
Console#
    
```

Table 186: show mvr6 statistics input - display description

Field	Description
Interface	Shows interfaces attached to the MVR.
Report	The number of IGMP membership reports received on this interface.
Leave	The number of leave messages received on this interface.
G Query	The number of general query messages received on this interface.
G(-S)-S Query	The number of group specific or group-and-source specific query messages received on this interface.

Table 186: show mvr6 statistics input - display description (Continued)

Field	Description
Drop	The number of times a report, leave or query was dropped. Packets may be dropped due to invalid format, rate limiting, packet content not allowed, or MVR group report received
Join Succ	The number of times a multicast group was successfully joined.
Group	The number of MVR groups active on this interface.

The following shows MVR6 protocol-related statistics sent:

```

Console#show mvr6 domain 1 statistics output
MVR6 Domain 1, MVR6 VLAN 2:
Output Statistics:
Interface  Report    Done      G Query  G(-S)-S Query Drop    Group
-----
Eth 1/ 1      12         0         1         0         0         0
Eth 1/ 3       5         1         4         1         0         0
DVLAN  1       7         2         3         0         0         0
MVLAN  2       7         2         3         0         0         0
Console#

```

Table 187: show mvr6 statistics output - display description

Field	Description
Interface	Shows interfaces attached to the MVR.
Report	The number of IGMP membership reports sent from this interface.
Leave	The number of leave messages sent from this interface.
G Query	The number of general query messages sent from this interface.
G(-S)-S Query	The number of group specific or group-and-source specific query messages sent from this interface.
Group	The number of MVR groups active on this interface.

The following shows MVR6 query-related statistics:

```

Console#show mvr6 domain 1 statistics query
Other Querier Address      : fe80::2e0:cff:fe00:fb/64
Other Querier Uptime       : 0(h):0(m):0(s)
Other Querier Expire Time  : 0(m):0(s)
Self Querier Address       : None
Self Querier Uptime        : 0(h):13(m):16(s)
Self Querier Expire Time   : 3(m):23(s)
General Query Received     : 0
General Query Sent         : 0
Specific Query Received    : 0
Specific Query Sent        : 0
Console#

```

Table 188: show mvr6 statistics query - display description

Field	Description
Other Querier Address	The IPv6 address of the querier on this interface.
Other Querier Uptime	Other querier's time up.
Other Querier Expire Time	The time after which this querier is assumed to have expired.
Self Querier Address	This querier's IPv6 address.
Self Querier Uptime	This querier's time up.
Self Querier Expire Time	This querier's expire time.
General Query Received	The number of general queries received on this interface.
General Query Sent	The number of general queries sent from this interface.
Specific Query Received	The number of specific queries received on this interface.
Specific Query Sent	The number of specific queries sent from this interface.

Link Layer Discovery Protocol (LLDP) is used to discover basic information about neighboring devices on the local broadcast domain. LLDP is a Layer 2 protocol that uses periodic broadcasts to advertise information about the sending device. Advertised information is represented in Type Length Value (TLV) format according to the IEEE 802.1AB standard, and can include details such as device identification, capabilities and configuration settings. LLDP also defines how to store and maintain information gathered about the neighboring network nodes it discovers.

Link Layer Discovery Protocol - Media Endpoint Discovery (LLDP-MED) is an extension of LLDP intended for managing endpoint devices such as Voice over IP phones and network switches. The LLDP-MED TLVs advertise information such as network policy, power, inventory, and device location details. LLDP and LLDP-MED information can be used by SNMP applications to simplify troubleshooting, enhance network management, and maintain an accurate network topology.

Table 189: LLDP Commands

Command	Function	Mode
<code>lldp</code>	Enables LLDP globally on the switch	GC
<code>lldp holdtime-multiplier</code>	Configures the time-to-live (TTL) value sent in LLDP advertisements	GC
<code>lldp med-fast-start-count</code>	Configures how many medFastStart packets are transmitted	GC
<code>lldp notification-interval</code>	Configures the allowed interval for sending SNMP notifications about LLDP changes	GC
<code>lldp refresh-interval</code>	Configures the periodic transmit interval for LLDP advertisements	GC
<code>lldp reinit-delay</code>	Configures the delay before attempting to re-initialize after LLDP ports are disabled or the link goes down	GC
<code>lldp tx-delay</code>	Configures a delay between the successive transmission of advertisements initiated by a change in local LLDP MIB variables	GC
<code>lldp admin-status</code>	Enables LLDP transmit, receive, or transmit and receive mode on the specified port	IC
<code>lldp basic-tlv management-ip-address</code>	Configures an LLDP-enabled port to advertise the management address for this device	IC
<code>lldp basic-tlv port-description</code>	Configures an LLDP-enabled port to advertise its port description	IC
<code>lldp basic-tlv system-capabilities</code>	Configures an LLDP-enabled port to advertise its system capabilities	IC
<code>lldp basic-tlv system-description</code>	Configures an LLDP-enabled port to advertise the system description	IC

Table 189: LLDP Commands (Continued)

Command	Function	Mode
<code>lldp basic-tlv system-name</code>	Configures an LLDP-enabled port to advertise its system name	IC
<code>lldp dot1-tlv proto-ident¹</code>	Configures an LLDP-enabled port to advertise the supported protocols	IC
<code>lldp dot1-tlv proto-vid¹</code>	Configures an LLDP-enabled port to advertise port related VLAN information	IC
<code>lldp dot1-tlv pvid¹</code>	Configures an LLDP-enabled port to advertise its default VLAN ID	IC
<code>lldp dot1-tlv vlan-name¹</code>	Configures an LLDP-enabled port to advertise its VLAN name	IC
<code>lldp dot3-tlv link-agg</code>	Configures an LLDP-enabled port to advertise its link aggregation capabilities	IC
<code>lldp dot3-tlv mac-phy</code>	Configures an LLDP-enabled port to advertise its MAC and physical layer specifications	IC
<code>lldp dot3-tlv max-frame</code>	Configures an LLDP-enabled port to advertise its maximum frame size	IC
<code>lldp dot3-tlv poe²</code>	Configures an LLDP-enabled port to advertise its Power-over-Ethernet capabilities	IC
<code>lldp med-location civic-addr</code>	Configures an LLDP-MED-enabled port to advertise its location identification details	IC
<code>lldp med-notification</code>	Enables the transmission of SNMP trap notifications about LLDP-MED changes	IC
<code>lldp med-tlv ext-poe²</code>	Configures an LLDP-MED-enabled port to advertise its extended Power over Ethernet configuration and usage information	IC
<code>lldp med-tlv inventory</code>	Configures an LLDP-MED-enabled port to advertise its inventory identification details	IC
<code>lldp med-tlv location</code>	Configures an LLDP-MED-enabled port to advertise its location identification details	IC
<code>lldp med-tlv med-cap</code>	Configures an LLDP-MED-enabled port to advertise its Media Endpoint Device capabilities	IC
<code>lldp med-tlv network-policy</code>	Configures an LLDP-MED-enabled port to advertise its network policy configuration	IC
<code>lldp notification</code>	Enables the transmission of SNMP trap notifications about LLDP changes	IC
<code>show lldp config</code>	Shows LLDP configuration settings for all ports	PE
<code>show lldp info local-device</code>	Shows LLDP global and interface-specific configuration settings for this device	PE
<code>show lldp info remote-device</code>	Shows LLDP global and interface-specific configuration settings for remote devices	PE
<code>show lldp info statistics</code>	Shows statistical counters for all LLDP-enabled interfaces	PE

1. Vendor-specific options may or may not be advertised by neighboring devices.

2. ES4110-28P/52P

lldp This command enables LLDP globally on the switch. Use the **no** form to disable LLDP.

SYNTAX

[no] lldp

DEFAULT SETTING

Enabled

COMMAND MODE

Global Configuration

EXAMPLE

```
Console(config)#lldp
Console(config)#
```

lldp holdtime-multiplier This command configures the time-to-live (TTL) value sent in LLDP advertisements. Use the **no** form to restore the default setting.

SYNTAX

lldp holdtime-multiplier *value*

no lldp holdtime-multiplier

value - Calculates the TTL in seconds based on the following rule:
minimum of ((Transmission Interval * Holdtime Multiplier), or 65536)

(Range: 2 - 10)

DEFAULT SETTING

Holdtime multiplier: 4

TTL: 4*30 = 120 seconds

COMMAND MODE

Global Configuration

COMMAND USAGE

The time-to-live tells the receiving LLDP agent how long to retain all information pertaining to the sending LLDP agent if it does not transmit updates in a timely manner.

EXAMPLE

```
Console(config)#lldp holdtime-multiplier 10
Console(config)#
```

lldp med-fast-start-count This command specifies the amount of MED Fast Start LLDPDUs to transmit during the activation process of the LLDP-MED Fast Start mechanism. Use the **no** form to restore the default setting.

SYNTAX

lldp med-fast-start-count *packets*

no lldp med-fast-start-count

seconds - Amount of packets. (Range: 1-10 packets;
Default: 4 packets)

DEFAULT SETTING

4 packets

COMMAND MODE

Global Configuration

COMMAND USAGE

This parameter is part of the timer which ensures that the LLDP-MED Fast Start mechanism is active for the port. LLDP-MED Fast Start is critical to the timely startup of LLDP, and therefore integral to the rapid availability of Emergency Call Service.

EXAMPLE

```
Console(config)#lldp med-fast-start-count 6
Console(config)#
```

lldp notification-interval This command configures the allowed interval for sending SNMP notifications about LLDP MIB changes. Use the **no** form to restore the default setting.

SYNTAX

lldp notification-interval *seconds*

no lldp notification-interval

seconds - Specifies the periodic interval at which SNMP notifications are sent. (Range: 5 - 3600 seconds)

DEFAULT SETTING

5 seconds

COMMAND MODE

Global Configuration

COMMAND USAGE

- ◆ This parameter only applies to SNMP applications which use data stored in the LLDP MIB for network monitoring or management.

- ◆ Information about changes in LLDP neighbors that occur between SNMP notifications is not transmitted. Only state changes that exist at the time of a notification are included in the transmission. An SNMP agent should therefore periodically check the value of `IldpStatsRemTableLastChangeTime` to detect any `IldpRemTablesChange` notification-events missed due to throttling or transmission loss.

EXAMPLE

```
Console(config)#lldp notification-interval 30
Console(config)#
```

Ildp refresh-interval This command configures the periodic transmit interval for LLDP advertisements. Use the **no** form to restore the default setting.

SYNTAX

Ildp refresh-interval *seconds*

no Ildp refresh-delay

seconds - Specifies the periodic interval at which LLDP advertisements are sent. (Range: 5 - 32768 seconds)

DEFAULT SETTING

30 seconds

COMMAND MODE

Global Configuration

EXAMPLE

```
Console(config)#lldp refresh-interval 60
Console(config)#
```

Ildp reinit-delay This command configures the delay before attempting to re-initialize after LLDP ports are disabled or the link goes down. Use the **no** form to restore the default setting.

SYNTAX

Ildp reinit-delay *seconds*

no Ildp reinit-delay

seconds - Specifies the delay before attempting to re-initialize LLDP. (Range: 1 - 10 seconds)

DEFAULT SETTING

2 seconds

COMMAND MODE

Global Configuration

COMMAND USAGE

When LLDP is re-initialized on a port, all information in the remote systems LLDP MIB associated with this port is deleted.

EXAMPLE

```
Console(config)#lldp reinit-delay 10
Console(config)#
```

lldp tx-delay This command configures a delay between the successive transmission of advertisements initiated by a change in local LLDP MIB variables. Use the **no** form to restore the default setting.

SYNTAX

lldp tx-delay *seconds*

no lldp tx-delay

seconds - Specifies the transmit delay. (Range: 1 - 8192 seconds)

DEFAULT SETTING

2 seconds

COMMAND MODE

Global Configuration

COMMAND USAGE

- ◆ The transmit delay is used to prevent a series of successive LLDP transmissions during a short period of rapid changes in local LLDP MIB objects, and to increase the probability that multiple, rather than single changes, are reported in each transmission.
- ◆ This attribute must comply with the following rule:
(4 * tx-delay) ≤ refresh-interval

EXAMPLE

```
Console(config)#lldp tx-delay 10
Console(config)#
```

lldp admin-status This command enables LLDP transmit, receive, or transmit and receive mode on the specified port. Use the **no** form to disable this feature.

SYNTAX

lldp admin-status {**rx-only** | **tx-only** | **tx-rx**}

no lldp admin-status

rx-only - Only receive LLDP PDUs.

tx-only - Only transmit LLDP PDUs.

tx-rx - Both transmit and receive LLDP Protocol Data Units (PDUs).

DEFAULT SETTING

tx-rx

COMMAND MODE

Interface Configuration (Ethernet, Port Channel)

EXAMPLE

```
Console(config)#interface ethernet 1/1
Console(config-if)#lldp admin-status rx-only
Console(config-if)#
```

lldp basic-tlv management-ip-address This command configures an LLDP-enabled port to advertise the management address for this device. Use the **no** form to disable this feature.

SYNTAX

[no] lldp basic-tlv management-ip-address

DEFAULT SETTING

Enabled

COMMAND MODE

Interface Configuration (Ethernet, Port Channel)

COMMAND USAGE

- ◆ The management address protocol packet includes the IPv4 address of the switch. If no management address is available, the address should be the MAC address for the CPU or for the port sending this advertisement.
- ◆ The management address TLV may also include information about the specific interface associated with this address, and an object identifier indicating the type of hardware component or protocol entity associated with this address. The interface number and OID are included to assist SNMP applications to perform network discovery by indicating

enterprise specific or other starting points for the search, such as the Interface or Entity MIB.

- ◆ Since there are typically a number of different addresses associated with a Layer 3 device, an individual LLDP PDU may contain more than one management address TLV.
- ◆ Every management address TLV that reports an address that is accessible on a port and protocol VLAN through the particular port should be accompanied by a port and protocol VLAN TLV that indicates the VLAN identifier (VID) associated with the management address reported by this TLV.

EXAMPLE

```
Console(config)#interface ethernet 1/1
Console(config-if)#lldp basic-tlv management-ip-address
Console(config-if)#
```

Ildp basic-tlv port-description This command configures an LLDP-enabled port to advertise its port description. Use the **no** form to disable this feature.

SYNTAX

[no] Ildp basic-tlv port-description

DEFAULT SETTING

Enabled

COMMAND MODE

Interface Configuration (Ethernet, Port Channel)

COMMAND USAGE

The port description is taken from the ifDescr object in RFC 2863, which includes information about the manufacturer, the product name, and the version of the interface hardware/software.

EXAMPLE

```
Console(config)#interface ethernet 1/1
Console(config-if)#lldp basic-tlv port-description
Console(config-if)#
```

lldp basic-tlv system-capabilities This command configures an LLDP-enabled port to advertise its system capabilities. Use the **no** form to disable this feature.

SYNTAX

[no] lldp basic-tlv system-capabilities

DEFAULT SETTING

Enabled

COMMAND MODE

Interface Configuration (Ethernet, Port Channel)

COMMAND USAGE

The system capabilities identifies the primary function(s) of the system and whether or not these primary functions are enabled. The information advertised by this TLV is described in IEEE 802.1AB.

EXAMPLE

```
Console(config)#interface ethernet 1/1
Console(config-if)#lldp basic-tlv system-capabilities
Console(config-if)#
```

lldp basic-tlv system-description This command configures an LLDP-enabled port to advertise the system description. Use the **no** form to disable this feature.

SYNTAX

[no] lldp basic-tlv system-description

DEFAULT SETTING

Enabled

COMMAND MODE

Interface Configuration (Ethernet, Port Channel)

COMMAND USAGE

The system description is taken from the sysDescr object in RFC 3418, which includes the full name and version identification of the system's hardware type, software operating system, and networking software.

EXAMPLE

```
Console(config)#interface ethernet 1/1
Console(config-if)#lldp basic-tlv system-description
Console(config-if)#
```

lldp basic-tlv system-name This command configures an LLDP-enabled port to advertise the system name. Use the **no** form to disable this feature.

SYNTAX

[no] lldp basic-tlv system-name

DEFAULT SETTING

Enabled

COMMAND MODE

Interface Configuration (Ethernet, Port Channel)

COMMAND USAGE

The system name is taken from the sysName object in RFC 3418, which contains the system's administratively assigned name, and is in turn based on the [hostname](#) command.

EXAMPLE

```
Console(config)#interface ethernet 1/1
Console(config-if)#lldp basic-tlv system-name
Console(config-if)#
```

lldp dot1-tlv proto-ident This command configures an LLDP-enabled port to advertise the supported protocols. Use the **no** form to disable this feature.

SYNTAX

[no] lldp dot1-tlv proto-ident

DEFAULT SETTING

Enabled

COMMAND MODE

Interface Configuration (Ethernet, Port Channel)

COMMAND USAGE

This option advertises the protocols that are accessible through this interface.

EXAMPLE

```
Console(config)#interface ethernet 1/1
Console(config-if)#no lldp dot1-tlv proto-ident
Console(config-if)#
```

lldp dot1-tlv proto-vid This command configures an LLDP-enabled port to advertise port-based protocol VLAN information. Use the **no** form to disable this feature.

SYNTAX

[no] lldp dot1-tlv proto-vid

DEFAULT SETTING

Enabled

COMMAND MODE

Interface Configuration (Ethernet, Port Channel)

COMMAND USAGE

This option advertises the port-based protocol VLANs configured on this interface (see ["Configuring Protocol-based VLANs" on page 1178](#)).

EXAMPLE

```
Console(config)#interface ethernet 1/1
Console(config-if)#no lldp dot1-tlv proto-vid
Console(config-if)#
```

lldp dot1-tlv pvid This command configures an LLDP-enabled port to advertise its default VLAN ID. Use the **no** form to disable this feature.

SYNTAX

[no] lldp dot1-tlv pvid

DEFAULT SETTING

Enabled

COMMAND MODE

Interface Configuration (Ethernet, Port Channel)

COMMAND USAGE

The port's default VLAN identifier (PVID) indicates the VLAN with which untagged or priority-tagged frames are associated (see the [switchport native vlan](#) command).

EXAMPLE

```
Console(config)#interface ethernet 1/1
Console(config-if)#no lldp dot1-tlv pvid
Console(config-if)#
```

lldp dot1-tlv vlan-name This command configures an LLDP-enabled port to advertise its VLAN name. Use the **no** form to disable this feature.

SYNTAX

[no] lldp dot1-tlv vlan-name

DEFAULT SETTING

Enabled

COMMAND MODE

Interface Configuration (Ethernet, Port Channel)

COMMAND USAGE

This option advertises the name of all VLANs to which this interface has been assigned. See [switchport allowed vlan](#) and [protocol-vlan protocol-group \(Configuring Interfaces\)](#).

EXAMPLE

```
Console(config)#interface ethernet 1/1
Console(config-if)#no lldp dot1-tlv vlan-name
Console(config-if)#
```

lldp dot3-tlv link-agg This command configures an LLDP-enabled port to advertise link aggregation capabilities. Use the **no** form to disable this feature.

SYNTAX

[no] lldp dot3-tlv link-agg

DEFAULT SETTING

Enabled

COMMAND MODE

Interface Configuration (Ethernet, Port Channel)

COMMAND USAGE

This option advertises link aggregation capabilities, aggregation status of the link, and the 802.3 aggregated port identifier if this interface is currently a link aggregation member.

EXAMPLE

```
Console(config)#interface ethernet 1/1
Console(config-if)#no lldp dot3-tlv link-agg
Console(config-if)#
```

lldp dot3-tlv mac-phy This command configures an LLDP-enabled port to advertise its MAC and physical layer capabilities. Use the **no** form to disable this feature.

SYNTAX

[no] lldp dot3-tlv mac-phy

DEFAULT SETTING

Enabled

COMMAND MODE

Interface Configuration (Ethernet, Port Channel)

COMMAND USAGE

This option advertises MAC/PHY configuration/status which includes information about auto-negotiation support/capabilities, and operational Multistation Access Unit (MAU) type.

EXAMPLE

```
Console(config)#interface ethernet 1/1
Console(config-if)#no lldp dot3-tlv mac-phy
Console(config-if)#
```

lldp dot3-tlv max-frame This command configures an LLDP-enabled port to advertise its maximum frame size. Use the **no** form to disable this feature.

SYNTAX

[no] lldp dot3-tlv max-frame

DEFAULT SETTING

Enabled

COMMAND MODE

Interface Configuration (Ethernet, Port Channel)

COMMAND USAGE

Refer to "[Frame Size](#)" on page 735 for information on configuring the maximum frame size for this switch.

EXAMPLE

```
Console(config)#interface ethernet 1/1
Console(config-if)#lldp dot3-tlv max-frame
Console(config-if)#
```

lldp dot3-tlv poe This command configures an LLDP-enabled port to advertise its Power-over-Ethernet (PoE) capabilities. Use the **no** form to disable this feature.

SYNTAX

[no] lldp dot3-tlv poe

DEFAULT SETTING

Enabled

COMMAND MODE

Interface Configuration (Ethernet, Port Channel)

COMMAND USAGE

- ◆ This option advertises Power-over-Ethernet capabilities, including whether or not PoE is supported, currently enabled, if the port pins through which power is delivered can be controlled, the port pins selected to deliver power, and the power class.
- ◆ This command only applies to the ES4110-28P/52P.

EXAMPLE

```
Console(config)#interface ethernet 1/1
Console(config-if)#lldp dot3-tlv poe
Console(config-if)#
```

lldp med-location civic-addr This command configures an LLDP-MED-enabled port to advertise its location identification details. Use the **no** form to restore the default settings.

SYNTAX

lldp med-location civic-addr [[**country** *country-code*] | [**what** *device-type*] | [*ca-type ca-value*]]

no lldp med-location civic-addr [[**country**] | [**what**] | [*ca-type*]]

country-code – The two-letter ISO 3166 country code in capital ASCII letters. (Example: DK, DE or US)

device-type – The type of device to which the location applies.

0 – Location of DHCP server.

1 – Location of network element closest to client.

2 – Location of client.

ca-type – A one-octet descriptor of the data civic address value. (Range: 0-255)

ca-value – Description of a location. (Range: 1-32 characters)

DEFAULT SETTING

Not advertised
No description

COMMAND MODE

Interface Configuration (Ethernet, Port Channel)

COMMAND USAGE

- ◆ Use this command without any keywords to advertise location identification details.
- ◆ Use the *ca-type* to advertise the physical location of the device, that is the city, street number, building and room information. The address location is specified as a type and value pair, with the civic address (CA) type being defined in RFC 4776. The following table describes some of the CA type numbers and provides examples.

Table 190: LLDP MED Location CA Types

CA Type	Description	CA Value Example
1	National subdivisions (state, canton, province)	California
2	County, parish	Orange
3	City, township	Irvine
4	City division, borough, city district	West Irvine
5	Neighborhood, block	Riverside
6	Group of streets below the neighborhood level	Exchange
18	Street suffix or type	Avenue
19	House number	320
20	House number suffix	A
21	Landmark or vanity address	Tech Center
26	Unit (apartment, suite)	Apt 519
27	Floor	5
28	Room	509B

Any number of CA type and value pairs can be specified for the civic address location, as long as the total does not exceed 250 characters.

- ◆ For the location options defined for *device-type*, normally option **2** is used to specify the location of the client device. In situations where the client device location is not known, **0** and **1** can be used, providing the client device is physically close to the DHCP server or network element.

EXAMPLE

The following example enables advertising location identification details.

```

Console(config)#interface ethernet 1/1
Console(config-if)#lldp med-location civic-addr
Console(config-if)#lldp med-location civic-addr 1 California
Console(config-if)#lldp med-location civic-addr 2 Orange
Console(config-if)#lldp med-location civic-addr 3 Irvine
Console(config-if)#lldp med-location civic-addr 4 West Irvine
Console(config-if)#lldp med-location civic-addr 6 Exchange
Console(config-if)#lldp med-location civic-addr 18 Avenue
Console(config-if)#lldp med-location civic-addr 19 320
Console(config-if)#lldp med-location civic-addr 27 5
Console(config-if)#lldp med-location civic-addr 28 509B
Console(config-if)#lldp med-location civic-addr country US
Console(config-if)#lldp med-location civic-addr what 2
Console(config-if)#

```

lldp med-notification This command enables the transmission of SNMP trap notifications about LLDP-MED changes. Use the **no** form to disable LLDP-MED notifications.

SYNTAX

[no] lldp med-notification

DEFAULT SETTING

Disabled

COMMAND MODE

Interface Configuration (Ethernet, Port Channel)

COMMAND USAGE

- ◆ This option sends out SNMP trap notifications to designated target stations at the interval specified by the [lldp notification-interval](#) command. Trap notifications include information about state changes in the LLDP MIB (IEEE 802.1AB), the LLDP-MED MIB (ANSI/TIA 1057), or organization-specific LLDP-EXT-DOT1 and LLDP-EXT-DOT3 MIBs.
- ◆ SNMP trap destinations are defined using the [snmp-server host](#) command.
- ◆ Information about additional changes in LLDP neighbors that occur between SNMP notifications is not transmitted. Only state changes that exist at the time of a trap notification are included in the transmission. An SNMP agent should therefore periodically check the value of `lldpStatsRemTableLastChangeTime` to detect any `lldpRemTablesChange` notification-events missed due to throttling or transmission loss.

EXAMPLE

```

Console(config)#interface ethernet 1/1
Console(config-if)#lldp med-notification
Console(config-if)#

```

lldp med-tlv ext-poe This command configures an LLDP-MED-enabled port to advertise and accept Extended Power-over-Ethernet configuration and usage information. Use the **no** form to disable this feature.

SYNTAX

[no] lldp med-tlv ext-poe

DEFAULT SETTING

Enabled

COMMAND MODE

Interface Configuration (Ethernet, Port Channel)

COMMAND USAGE

- ◆ This option advertises extended Power-over-Ethernet capability details, such as power availability from the switch, and power state of the switch, including whether the switch is operating from primary or backup power (the Endpoint Device could use this information to decide to enter power conservation mode). Note that this device does not support PoE capabilities.
- ◆ This command only applies to the ES4110-28P/52P.

EXAMPLE

```
Console(config)#interface ethernet 1/1
Console(config-if)#no lldp med-tlv ext-poe
Console(config-if)#
```

lldp med-tlv inventory This command configures an LLDP-MED-enabled port to advertise its inventory identification details. Use the **no** form to disable this feature.

SYNTAX

[no] lldp med-tlv inventory

DEFAULT SETTING

Enabled

COMMAND MODE

Interface Configuration (Ethernet, Port Channel)

COMMAND USAGE

This option advertises device details useful for inventory management, such as manufacturer, model, software version and other pertinent information.

EXAMPLE

```

Console(config)#interface ethernet 1/1
Console(config-if)#no lldp med-tlv inventory
Console(config-if)#

```

lldp med-tlv location This command configures an LLDP-MED-enabled port to advertise its location identification details. Use the **no** form to disable this feature.

SYNTAX

[no] lldp med-tlv location

DEFAULT SETTING

Enabled

COMMAND MODE

Interface Configuration (Ethernet, Port Channel)

COMMAND USAGE

This option advertises location identification details.

EXAMPLE

```

Console(config)#interface ethernet 1/1
Console(config-if)#lldp med-tlv location
Console(config-if)#

```

lldp med-tlv med-cap This command configures an LLDP-MED-enabled port to advertise its Media Endpoint Device capabilities. Use the **no** form to disable this feature.

SYNTAX

[no] lldp med-tlv med-cap

DEFAULT SETTING

Enabled

COMMAND MODE

Interface Configuration (Ethernet, Port Channel)

COMMAND USAGE

This option advertises LLDP-MED TLV capabilities, allowing Media Endpoint and Connectivity Devices to efficiently discover which LLDP-MED related TLVs are supported on the switch.

EXAMPLE

```
Console(config)#interface ethernet 1/1
Console(config-if)#lldp med-tlv med-cap
Console(config-if)#
```

lldp med-tlv network-policy This command configures an LLDP-MED-enabled port to advertise its network policy configuration. Use the **no** form to disable this feature.

SYNTAX

[no] lldp med-tlv network-policy

DEFAULT SETTING

Enabled

COMMAND MODE

Interface Configuration (Ethernet, Port Channel)

COMMAND USAGE

This option advertises network policy configuration information, aiding in the discovery and diagnosis of VLAN configuration mismatches on a port. Improper network policy configurations frequently result in voice quality degradation or complete service disruption.

EXAMPLE

```
Console(config)#interface ethernet 1/1
Console(config-if)#lldp med-tlv network-policy
Console(config-if)#
```

lldp notification This command enables the transmission of SNMP trap notifications about LLDP changes. Use the **no** form to disable LLDP notifications.

SYNTAX

[no] lldp notification

DEFAULT SETTING

Enabled

COMMAND MODE

Interface Configuration (Ethernet, Port Channel)

COMMAND USAGE

- ◆ This option sends out SNMP trap notifications to designated target stations at the interval specified by the [lldp notification-interval](#) command. Trap notifications include information about state changes in the LLDP MIB (IEEE 802.1AB), or organization-specific LLDP-EXT-DOT1 and LLDP-EXT-DOT3 MIBs.

- ◆ SNMP trap destinations are defined using the `snmp-server host` command.
- ◆ Information about additional changes in LLDP neighbors that occur between SNMP notifications is not transmitted. Only state changes that exist at the time of a trap notification are included in the transmission. An SNMP agent should therefore periodically check the value of `lldpStatsRemTableLastChangeTime` to detect any `lldpRemTablesChange` notification-events missed due to throttling or transmission loss.

EXAMPLE

```
Console(config)#interface ethernet 1/1
Console(config-if)#lldp notification
Console(config-if)#
```

show lldp config This command shows LLDP configuration settings for all ports.

SYNTAX

show lldp config [**detail** *interface*]

detail - Shows configuration summary.

interface

ethernet *unit/port*

unit - Unit identifier. (Range: 1)

port - Port number. (Range: 1-28/52)

port-channel *channel-id* (Range: 1-16)

COMMAND MODE

Privileged Exec

EXAMPLE

The following example shows all basic LLDP parameters are enabled on Port 1.

```
Console#show lldp config
LLDP Global Configuration
LLDP Enabled                : Yes
LLDP Transmit Interval     : 30 seconds
LLDP Hold Time Multiplier  : 4
LLDP Delay Interval        : 2 seconds
LLDP Re-initialization Delay : 2 seconds
LLDP Notification Interval : 5 seconds
LLDP MED Fast Start Count  : 4

LLDP Port Configuration
Port      Admin Status Notification Enabled
-----
Eth 1/1   Tx-Rx          True
Eth 1/2   Tx-Rx          True
Eth 1/3   Tx-Rx          True
```

```

Eth 1/4 Tx-Rx      True
Eth 1/5 Tx-Rx      True
.
.
Console#show lldp config detail ethernet 1/1
LLDP Port Configuration Detail
Port                : Eth 1/1
Admin Status        : Tx-Rx
Notification Enabled : True
Basic TLVs Advertised : port-description
                    : system-name
                    : system-description
                    : system-capabilities
                    : management-ip-address

802.1 specific TLVs Advertised : port-vid
                    : vlan-name
                    : proto-vlan
                    : proto-ident

802.3 specific TLVs Advertised : mac-phy
                    : poe
                    : link-agg
                    : max-frame

MED Notification Status : Enabled
MED Enabled TLVs Advertised : med-cap
                    : network-policy
                    : location
                    : ext-poe
                    : inventory

MED Location Identification:
Location Data Format : Civic Address LCI
Country Name        : US
What                : 2
CA-Type             : 1
CA-Value            : Alabama
CA-Type             : 2
CA-Value            : Tuscaloosa

Console#

```

show lldp info local-device This command shows LLDP global and interface-specific configuration settings for this device.

SYNTAX

show lldp info local-device [**detail** *interface*]

detail - Shows configuration summary.

interface

ethernet *unit/port*

unit - Unit identifier. (Range: 1)

port - Port number. (Range: 1-28/52)

port-channel *channel-id* (Range: 1-16)

COMMAND MODE

Privileged Exec

EXAMPLE

```

Console#show lldp info local-device
LLDP Local Global Information
Chassis Type           : MAC Address
Chassis ID             : B4-0E-DC-34-96-08
System Name           :
System Description     : ECS4110-52P
System Capabilities Support : Bridge
System Capabilities Enabled : Bridge
Management Address    : 192.168.0.4 (IPv4)

LLDP Port Information
Port   PortID Type   PortID           Port Description
-----
Eth 1/1 MAC Address  00-1A-7E-AC-2B-13 Ethernet Port on unit 1, port 1
Eth 1/2 MAC Address  00-1A-7E-AC-2B-14 Ethernet Port on unit 1, port 2
Eth 1/3 MAC Address  00-1A-7E-AC-2B-15 Ethernet Port on unit 1, port 3
Eth 1/4 MAC Address  00-1A-7E-AC-2B-16 Ethernet Port on unit 1, port 4
.
.
.
Console#show lldp info local-device detail ethernet 1/1
LLDP Local Port Information Detail
Port           : Eth 1/1
Port ID Type   : MAC Address
Port ID        : B4-0E-DC-34-96-09
Port Description : Ethernet Port on unit 1, port 1
MED Capability  : LLDP-MED Capabilities
                  Network Policy
                  Location Identification
                  Extended Power via MDI - PSE
                  Extended Power via MDI - PD
                  Inventory

Console#

```

show lldp info remote-device This command shows LLDP global and interface-specific configuration settings for remote devices attached to an LLDP-enabled port.

SYNTAX

show lldp info remote-device [**detail** *interface*]

detail - Shows configuration summary.

interface

ethernet *unit/port*

unit - Unit identifier. (Range: 1)

port - Port number. (Range: 1-28/52)

port-channel *channel-id* (Range: 1-16)

COMMAND MODE

Privileged Exec

EXAMPLE

Note that an IP phone or other end-node device which advertises LLDP-MED capabilities must be connected to the switch for information to be displayed in the "Device Class" field.

```

Console#show lldp info remote-device
LLDP Remote Devices Information
Local Port Chassis ID      Port ID      System Name
-----
Eth 1/1      00-E0-0C-10-90-00 00-E0-0C-10-90-04
Eth 1/2      70-72-CF-5B-DA-D4 70-72-CF-5B-DA-D6

```

```

Console#show lldp info remote-device detail ethernet 1/1
LLDP Remote Devices Information Detail
-----

```

```

Index                : 4
Chassis Type         : MAC Address
Chassis ID           : FC-0A-81-B7-C7-E0
Port ID Type         : MAC Address
Port ID              : FC-0A-81-B7-C7-E1
Time To Live         : 120 seconds
Port Description      : Ethernet Port on unit 1, port 1
System Description   : ECS3510-28P
System Capabilities  : Bridge
Enabled Capabilities : Bridge

Management Address  : 192.168.0.4 (IPv4)

Port VLAN ID        : 1

Port and Protocol VLAN ID : VLAN    2 - supported, enabled

VLAN Name           : VLAN    1 - DefaultVlan

Protocol Identity (Hex) : 88-CC

MAC/PHY Configuration/Status
Port Auto-neg Supported      : Yes
Port Auto-neg Enabled        : Yes
Port Auto-neg Advertised Cap (Hex) : 6C00
Port MAU Type                : 16

Remote Power via MDI
Remote power class           : PSE
Remote power MDI supported   : Yes
Remote power MDI enabled     : Yes
Remote power pair controllable : No
Remote power pairs           : Spare
Remote power classification   : Class1

Link Aggregation
Link Aggregation Capable    : Yes
Link Aggregation Enable     : No
Link Aggregation Port ID    : 0

Remote Max Frame Size       : 1522

```

```

Console#

```

show lldp info statistics This command shows statistics based on traffic received through all attached LLDP-enabled interfaces.

SYNTAX

show lldp info statistics [**detail** *interface*]

detail - Shows configuration summary.

interface

ethernet *unit/port*

unit - Unit identifier. (Range: 1)

port - Port number. (Range: 1-28/52)

port-channel *channel-id* (Range: 1-16)

COMMAND MODE

Privileged Exec

EXAMPLE

```
switch#show lldp info statistics
LLDP Global Statistics
Neighbor Entries List Last Updated : 49 seconds
New Neighbor Entries Count       : 4
Neighbor Entries Deleted Count    : 0
Neighbor Entries Dropped Count    : 0
Neighbor Entries Ageout Count     : 0

Port      NumFramesRecvd NumFramesSent NumFramesDiscarded
-----
Eth 1/1   0             870           0
Eth 1/2   866           867           0
Eth 1/3   867           868           0
Eth 1/4   0             869           0
Eth 1/5   849           862           0
:
switch#show lldp info statistics detail ethernet 1/1
LLDP Port Statistics Detail
PortName      : Eth 1/1
Frames Discarded : 0
Frames Invalid : 0
Frames Received : 168
Frames Sent    : 172
TLVs Unrecognized : 0
TLVs Discarded  : 0
Neighbor Ageouts : 2
switch#
```

Connectivity Fault Management (CFM) is an OAM protocol that includes proactive connectivity monitoring using continuity check messages, fault verification through loop back messages, and fault isolation by examining end-to-end connections between provider edge devices or between customer edge devices.

CFM is implemented as a service level protocol based on service instances which encompass only that portion of the metropolitan area network supporting a specific customer. CFM can also provide controlled management access to a hierarchy of maintenance domains (such as the customer, service provider, and equipment operator).

The following list of commands support functions for defining the CFM structure, including domains, maintenance associations, and maintenance access points. It also provides commands for fault detection through continuity check messages for all known maintenance points, and cross-check messages for statically configured maintenance points located on other devices. Fault verification is supported through loop back messages, and fault isolation through link trace messages. Fault notification is also provided by SNMP alarms which are automatically generated by maintenance points when connectivity faults or configuration errors are detected in the local maintenance domain.

Table 191: CFM Commands

Command	Function	Mode
<i>Defining CFM Structures</i>		
<code>ethernet cfm ais level</code>	Configures the maintenance level at which Alarm Indication Signal information will be sent	GC
<code>ethernet cfm ais ma</code>	Enables the MEPs within the specified MA to send frames with AIS information	GC
<code>ethernet cfm ais period</code>	Configures the interval at which AIS information is sent	GC
<code>ethernet cfm ais suppress alarm</code>	Suppresses AIS messages following the detection of defect conditions	GC
<code>ethernet cfm domain</code>	Defines a CFM maintenance domain, sets the authorized maintenance level, and enters CFM configuration mode; also specifies the MIP creation method for MAs within this domain	GC
<code>ethernet cfm enable</code>	Enables CFM processing globally on the switch	GC
<code>ma index name</code>	Creates a maintenance association within the current maintenance domain, maps it to a customer service instance, and sets the manner in which MIPs are created for this service instance	CFM
<code>ma index name-format</code>	Specifies the name format for the maintenance association as IEEE 802.1ag character based, or ITU-T SG13/SG15 Y.1731 defined ICC-based format	CFM

Table 191: CFM Commands (Continued)

Command	Function	Mode
<code>ethernet cfm mep</code>	Sets an interface as a domain boundary, defines it as a maintenance end point (MEP), and sets direction of the MEP in regard to sending and receiving CFM messages	IC
<code>ethernet cfm port-enable</code>	Enables CFM processing on an interface	IC
<code>clear ethernet cfm ais mpid</code>	Clears AIS defect information for the specified MEP	PE
<code>show ethernet cfm configuration</code>	Displays CFM configuration settings, including global settings, SNMP traps, and interface settings	PE
<code>show ethernet cfm md</code>	Displays configured maintenance domains	PE
<code>show ethernet cfm ma</code>	Displays configured maintenance associations	PE
<code>show ethernet cfm maintenance-points local</code>	Displays maintenance points configured on this device	PE
<code>show ethernet cfm maintenance-points local detail mep</code>	Displays detailed CFM information about a specified local MEP in the continuity check database	PE
<code>show ethernet cfm maintenance-points remote detail</code>	Displays detailed CFM information about a specified remote MEP in the continuity check database	PE
<i>Continuity Check Operations</i>		
<code>ethernet cfm cc ma interval</code>	Sets the transmission delay between continuity check messages	GC
<code>ethernet cfm cc enable</code>	Enables transmission of continuity check messages within a specified maintenance association	GC
<code>snmp-server enable traps ethernet cfm cc</code>	Enables SNMP traps for CFM continuity check events	GC
<code>mep archive-hold-time</code>	Sets the time that data from a missing MEP is kept in the continuity check database before being purged	CFM
<code>clear ethernet cfm maintenance-points remote</code>	Clears the contents of the continuity check database	PE
<code>clear ethernet cfm errors</code>	Clears continuity check errors logged for the specified maintenance domain and maintenance level	PE
<code>show ethernet cfm errors</code>	Displays CFM continuity check errors logged on this device	PE
<i>Cross Check Operations</i>		
<code>ethernet cfm mep crosscheck start-delay</code>	Sets the maximum delay that a device waits for remote MEPs to come up before starting the cross-check operation	GC
<code>snmp-server enable traps ethernet cfm crosscheck</code>	Enables SNMP traps for CFM continuity check events, in relation to the cross-check operations between statically configured MEPs and those learned via continuity check messages	GC
<code>mep crosscheck mpid</code>	Statically defines a remote MEP in a maintenance association	CFM
<code>ethernet cfm mep crosscheck</code>	Enables cross-checking between the list of configured remote MEPs within a maintenance association and MEPs learned through continuity check messages	PE
<code>show ethernet cfm maintenance-points remote crosscheck</code>	Displays information about remote maintenance points configured statically in a cross-check list	PE

Table 191: CFM Commands (Continued)

Command	Function	Mode
<i>Link Trace Operations</i>		
<code>ethernet cfm linktrace cache</code>	Enables caching of CFM data learned through link trace messages	GC
<code>ethernet cfm linktrace cache hold-time</code>	Sets the hold time for CFM link trace cache entries	GC
<code>ethernet cfm linktrace cache size</code>	Sets the maximum size for the link trace cache	GC
<code>ethernet cfm linktrace</code>	Sends CFM link trace messages to the MAC address for a MEP	PE
<code>clear ethernet cfm linktrace-cache</code>	Clears link trace messages logged on this device	PE
<code>show ethernet cfm linktrace-cache</code>	Displays the contents of the link trace cache	PE
<i>Loopback Operations</i>		
<code>ethernet cfm loopback</code>	Sends CFM loopback messages to a MAC address for a MEP or MIP	PE
<i>Fault Generator Operations</i>		
<code>mep fault-notify alarm-time</code>	Sets the time a defect must exist before a fault alarm is issued	CFM
<code>mep fault-notify lowest-priority</code>	Sets the lowest priority defect that is allowed to generate a fault alarm	CFM
<code>mep fault-notify reset-time</code>	Configures the time after a fault alarm has been issued, and no defect exists, before another fault alarm can be issued	CFM
<code>show ethernet cfm fault-notify-generator</code>	Displays configuration settings for the fault notification generator	PE
<i>Delay Measure Operations</i>		
<code>ethernet cfm delay-measure two-way</code>	Sends periodic delay-measure requests to a specified MEP within a maintenance association	PE

Basic Configuration Steps for CFM

1. Configure the maintenance domains with the `ethernet cfm domain` command.
2. Configure the maintenance associations with the `ma index name` command.
3. Configure the local maintenance end points (MEPs) which will serve as the domain service access points for the specified maintenance association using the `ethernet cfm mep` command.
4. Enter a static list of MEPs assigned to other devices within the same maintenance association using the `mep crosscheck mpid` command. This allows CFM to automatically verify the functionality of these remote end points by cross-checking the static list configured on this device against information learned through continuity check messages.

5. Enable CFM globally on the switch with the `ethernet cfm enable` command.
6. Enable CFM on the local MEPs with the `ethernet cfm port-enable` command.
7. Enable continuity check operations with the `ethernet cfm cc enable` command.
8. Enable cross-check operations with the `ethernet cfm mep crosscheck` command.

Other configuration changes may be required for your particular environment, such as adjusting the interval at which continuity check messages are sent (page 1367), or setting the start-up delay for the cross-check operation (page 1373). You can also enable SNMP traps for events discovered by continuity check messages (page 1369) or cross-check messages (page 1373).

Defining CFM Structures

ethernet cfm ais level This command configures the maintenance level at which Alarm Indication Signal (AIS) information will be sent within the specified MA. Use the **no** form restore the default setting.

SYNTAX

ethernet cfm ais level *level-id* **md** *domain-name* **ma** *ma-name*
no ethernet cfm ais level md *domain-name* **ma** *ma-name*

level-id – Maintenance level at which AIS information will be sent. (Range: 0-7)

domain-name – Domain name. (Range: 1-43 alphanumeric characters)

ma-name – Maintenance association name. (Range: 1-43 alphanumeric characters)

DEFAULT SETTING

Level 0

COMMAND MODE

Global Configuration

COMMAND USAGE

The configured AIS level must be higher than the maintenance level of the domain containing the specified MA.

EXAMPLE

This example sets the maintenance level for sending AIS messages within the specified MA.

```
Console(config)#ethernet cfm ais level 4 md voip ma rd
Console(config)#
```

ethernet cfm ais ma This command enables the MEPs within the specified MA to send frames with AIS information following detection of defect conditions. Use the **no** form to disable this feature.

SYNTAX

[no] ethernet cfm ais md domain-name ma ma-name

domain-name – Domain name. (Range: 1-43 alphanumeric characters)

ma-name – Maintenance association name³². (Range: 1-43 alphanumeric characters)

DEFAULT SETTING

Enabled

COMMAND MODE

Global Configuration

COMMAND USAGE

- ◆ Each MA name must be unique within the CFM domain.
- ◆ Frames with AIS information can be issued at the client's maintenance level by a MEP upon detecting defect conditions. For example, defect conditions may include:
 - Signal failure conditions if continuity checks are enabled.
 - AIS condition or LCK condition if continuity checks are disabled.
- ◆ A MEP continues to transmit periodic frames with AIS information until the defect condition is removed.

EXAMPLE

This example enables the MEPs within the specified MA to send frames with AIS information.

```
Console(config)#ethernet cfm ais md voip ma rd
Console(config)#
```

³². The total length of the MD name and MA name cannot exceed 44 characters.

ethernet cfm ais period This command configures the interval at which AIS information is sent. Use the **no** form to restore the default setting.

SYNTAX

ethernet cfm ais period *period* **md** *domain-name* **ma** *ma-name*

no ethernet cfm ais period **md** *domain-name* **ma** *ma-name*

period – The interval at which AIS information is sent.
(Options: 1 second, 60 seconds)

domain-name – Domain name. (Range: 1-43 alphanumeric characters)

ma-name – Maintenance association name. (Range: 1-43 alphanumeric characters)

DEFAULT SETTING

1 second

COMMAND MODE

Global Configuration

EXAMPLE

This example sets the interval for sending frames with AIS information at 60 seconds.

```
Console(config)#ethernet cfm ais period 60 md voip ma rd
Console(config)#
```

ethernet cfm ais suppress alarm This command suppresses sending frames containing AIS information following the detection of defect conditions. Use the **no** form to restore the default setting.

SYNTAX

[no] ethernet cfm ais suppress alarm **md** *domain-name*
ma *ma-name*

domain-name – Domain name. (Range: 1-43 alphanumeric characters)

ma-name – Maintenance association name. (Range: 1-43 alphanumeric characters)

DEFAULT SETTING

Suppression is disabled

COMMAND MODE

Global Configuration

COMMAND USAGE

- ◆ For multipoint connectivity, a MEP cannot determine the specific maintenance level entity that has encountered defect conditions upon receiving a frame with AIS information. More importantly, it cannot determine the associated subset of its peer MEPs for which it should suppress alarms since the received AIS information does not contain that information. Therefore, upon reception of a frame with AIS information, the MEP will suppress alarms for all peer MEPs whether there is still connectivity or not.
- ◆ However, for a point-to-point connection, a MEP has only a single peer MEP for which to suppress alarms when it receives frames with AIS information.
- ◆ If suppression is enabled by this command, upon receiving a frame with AIS information, a MEP detects an AIS condition and suppresses loss of continuity alarms associated with all its peer MEPs. A MEP resumes loss of continuity alarm generation upon detecting loss of continuity defect conditions in the absence of AIS messages.

EXAMPLE

This example suppresses sending frames with AIS information.

```
Console(config)#ethernet cfm ais suppress alarm md voip ma rd
Console(config)#
```

ethernet cfm domain

This command defines a CFM maintenance domain, sets the authorized maintenance level, and enters CFM configuration mode. Use the **no** form to delete a CFM maintenance domain.

SYNTAX

ethernet cfm domain index *index* **name** *domain-name* **level** *level-id* [**mip-creation** *type*]

no ethernet cfm domain index *index*

index – Domain index. (Range: 1-65535)

domain-name – Domain name. (Range: 1-43 alphanumeric characters)

level-id – Authorized maintenance level for this domain. (Range: 0-7)

type – Specifies the CFM protocol's creation method for maintenance intermediate points (MIPs) in this domain:

default – MIPs can be created for any maintenance association (MA) configured in this domain on any bridge port through which the MA's VID can pass.

explicit – MIPs can be created for any MA configured in this domain only on bridge ports through which the MA's VID can

pass, and only if a maintenance end point (MEP) is created at some lower MA Level.

none – No MIP can be created for any MA configured in this domain.

DEFAULT SETTING

No maintenance domains are configured.

No MIPs are created for any MA in the specified domain.

COMMAND MODE

Global Configuration

COMMAND USAGE

- ◆ A domain can only be configured with one name.
- ◆ Where domains are nested, an upper-level hierarchical domain must have a higher maintenance level than the ones it encompasses. The higher to lower level domain types commonly include entities such as customer, service provider, and operator.
- ◆ More than one domain can be configured at the same maintenance level, but a single domain can only be configured with one maintenance level.
- ◆ If MEPs or MAs are configured for a domain using the `ethernet cfm mep` command or `ma index name` command, they must first be removed before you can remove the domain.
- ◆ Maintenance domains are designed to provide a transparent method of verifying and resolving connectivity problems for end-to-end connections. By default, these connections run between the domain service access points (DSAPs) within each MA defined for a domain, and are manually configured using the `ethernet cfm mep` command.

In contrast, MIPs are interconnection points that make up all possible paths between the DSAPs within an MA. MIPs are automatically generated by the CFM protocol when the *mip-creation* option in this command is set to "default" or "explicit," and the MIP creation state machine is invoked (as defined in IEEE 802.1ag). The default option allows MIPs to be created for all interconnection points within an MA, regardless of the domain's level in the maintenance hierarchy (e.g., customer, provider, or operator). While the explicit option only generates MIPs within an MA if its associated domain is not at the bottom of the maintenance hierarchy. This option is used to hide the structure of network at the lowest domain level.

The diagnostic functions provided by CFM can be used to detect connectivity failures between any pair of MEPs in an MA. Using MIPs allows these failures to be isolated to smaller segments of the network.

Allowing the CFM to generate MIPs exposes more of the network structure to users at higher domain levels, but can speed up the process of fault detection and recovery. This trade-off should be carefully considered when designing a CFM maintenance structure.

Also note that while MEPs are active agents which can initiate consistency check messages (CCMs), transmit loop back or link trace messages, and maintain the local CCM database. MIPs, on the other hand are passive agents which can only validate received CFM messages, and respond to loop back and link trace messages.

The MIP creation method defined by the `ma index name` command takes precedence over the method defined by this command.

EXAMPLE

This example creates a maintenance domain set to maintenance level 3, and enters CFM configuration mode for this domain.

```
Console(config)#ethernet cfm domain index 1 name voip level 3 mip-creation
explicit
Console(config-ether-cfm)#
```

RELATED COMMANDS

[ma index name \(1356\)](#)

ethernet cfm enable This command enables CFM processing globally on the switch. Use the **no** form to disable CFM processing globally.

SYNTAX

[no] ethernet cfm enable

DEFAULT SETTING

Disabled

COMMAND MODE

Global Configuration

COMMAND USAGE

- ◆ To avoid generating an excessive number of traps, the complete CFM maintenance structure and process parameters should be configured prior to globally enabling CFM processing with this command. Specifically, the maintenance domains, maintenance associations, and MEPs should be configured on each participating bridge.
- ◆ When CFM is enabled, hardware resources are allocated for CFM processing.

EXAMPLE

This example enables CFM globally on the switch.

```
Console(config)#ethernet cfm enable
Console(config)#
```

ma index name This command creates a maintenance association (MA) within the current maintenance domain, maps it to a customer service instance (S-VLAN), and sets the manner in which MIPs are created for this service instance. Use the **no** form with the **vlan** keyword to remove the S-VLAN from the specified MA. Or use the **no** form with only the **index** keyword to remove the MA from the current domain.

SYNTAX

ma index *index name* *ma-name* [**vlan** *vlan-id* [**mip-creation** *type*]]

no ma index *index* [**vlan** *vlan-id*]

index – MA identifier. (Range: 1-2147483647)

ma-name – MA name. (Range: 1-43 alphanumeric characters)

vlan-id – Service VLAN ID. (Range: 1-4094)

type – Specifies the CFM protocol's creation method for maintenance intermediate points (MIPs) in this MA:

default – MIPs can be created for this MA on any bridge port through which the MA's VID can pass.

explicit – MIPs can be created this MA only on bridge ports through which the MA's VID can pass, and only if a maintenance end point (MEP) is created at some lower MA Level.

none – No MIP can be created for this MA.

DEFAULT SETTING

10 seconds

COMMAND MODE

CFM Domain Configuration

COMMAND USAGE

- ◆ The maintenance domain used to enter CFM domain configuration mode, the MA name and VLAN identifier specified by this command, and the DSAPs configured with the [mep crosscheck mpid](#) command create a unique service instance for each customer.
- ◆ If only the MA index and name are entered for this command, the MA will be recorded in the domain database, but will not function. No MEPs can be created until the MA is associated with a service VLAN.
- ◆ Note that multiple domains at the same maintenance level (see the [ethernet cfm domain](#) command) cannot have an MA on the same VLAN. Also, each MA name must be unique within the CFM-managed network.
- ◆ Before removing an MA, first remove all the MEPs configured for it (see the [mep crosscheck mpid](#) command).
- ◆ If the MIP creation method is not defined by this command, the creation method defined by the [ethernet cfm domain](#) command is applied to this MA. For a detailed description of the MIP types, refer to the Command Usage section under the [ethernet cfm domain](#) command.

EXAMPLE

This example creates a maintenance association, binds it to VLAN 1, and allows MIPs to be created within this MA using the default method.

```
Console(config)#ethernet cfm domain index 1 name voip level 3
Console(config-ether-cfm)#ma index 1 name rd vlan 1 mip-creation default
Console(config-ether-cfm)#
```

**ma index
name-format**

This command specifies the name format for the maintenance association as IEEE 802.1ag character based, or ITU-T SG13/SG15 Y.1731 defined ICC-based format. Use the **no** form to restore the default setting.

SYNTAX

ma index *index* **name-format** {**character-string** | **icc-based**}

no ma index *index* **name-format**

index – MA identifier. (Range: 1-2147483647)

character-string – IEEE 802.1ag defined character string format. This is an IETF RFC 2579 DisplayString.

icc-based – ITU-T SG13/SG15 Y.1731 defined ICC based format.

DEFAULT SETTING

character-string

COMMAND MODE

CFM Domain Configuration

EXAMPLE

This example specifies the name format as character string.

```
Console(config)#ethernet cfm domain index 1 name voip level 3
Console(config-ether-cfm)#ma index 1 name-format character-string
Console(config-ether-cfm)#
```

ethernet cfm mep This command sets an interface as a domain boundary, defines it as a maintenance end point (MEP), and sets direction of the MEP in regard to sending and receiving CFM messages. Use the **no** form to delete a MEP.

SYNTAX

ethernet cfm mep mpid *mpid* **md** *domain-name* **ma** *ma-name* [**up**]

no ethernet cfm mep mpid *mpid* **ma** *ma-name*

mpid – Maintenance end point identifier. (Range: 1-8191)

domain-name – Domain name. (Range: 1-43 alphanumeric characters)

ma-name – Maintenance association name. (Range: 1-43 alphanumeric characters)

up – Indicates that the MEP faces inward toward the switch cross-connect matrix, and transmits CFM messages towards, and receives them from, the direction of the internal bridge relay mechanism. If the **up** keyword is not included in this command, then the MEP is facing away from the switch, and transmits CFM messages towards, and receives them from, the direction of the physical medium.

DEFAULT SETTING

No MEPs are configured.
The MEP faces outward (down).

COMMAND MODE

Interface Configuration (Ethernet, Port Channel)

COMMAND USAGE

- ◆ CFM elements must be configured in the following order: (1) maintenance domain at the same level as the MEP to be configured (using the [ethernet cfm domain](#) command), (2) maintenance association within the domain (using the [ma index name](#) command), and (3) finally the MEP using this command.
- ◆ An interface may belong to more than one domain. This command can be used to configure an interface as a MEP for different MAs in different domains.
- ◆ To change the MEP's MA or the direction it faces, first delete the MEP, and then create a new one.

EXAMPLE

This example sets port 1 as a DSAP for the specified maintenance association.

```
Console(config)#interface ethernet 1/1
Console(config-if)#ethernet cfm mep mpid 1 md voip ma rd
Console(config-if)#
```

ethernet cfm port-enable This command enables CFM processing on an interface. Use the **no** form to disable CFM processing on an interface.

SYNTAX

[no] ethernet cfm port-enable

DEFAULT SETTING

Enabled

COMMAND MODE

Interface Configuration (Ethernet, Port Channel)

COMMAND USAGE

- ◆ An interface must be enabled before a MEP can be created with the **ethernet cfm mep** command.
- ◆ If a MEP has been configured on an interface with the **ethernet cfm mep** command, it must first be deleted before CFM can be disabled on that interface.
- ◆ When CFM is disabled, hardware resources previously used for CFM processing on that interface are released, and all CFM frames entering that interface are forwarded as normal data traffic.

EXAMPLE

This example enables CFM on port 1.

```
Console(config)#interface ethernet 1/1
Console(config-if)#ethernet cfm port-enable
Console(config-if)#
```

clear ethernet cfm ais mpid This command clears AIS defect information for the specified MEP.

SYNTAX

clear ethernet cfm ais mpid *mpid md domain-name ma ma-name*

mpid – Maintenance end point identifier. (Range: 1-8191)

domain-name – Domain name. (Range: 1-43 alphanumeric characters)

ma-name – Maintenance association name. (Range: 1-43 alphanumeric characters)

DEFAULT SETTING

None

COMMAND MODE

Privileged Exec

COMMAND USAGE

This command can be used to clear AIS defect entries if a MEP does not exit the AIS state when all errors are resolved.

EXAMPLE

This example clears AIS defect entries on port 1.

```
Console#clear ethernet cfm ais mpid 1 md voip ma rd
Console(config)#
```

show ethernet cfm configuration This command displays CFM configuration settings, including global settings, SNMP traps, and interface settings.

SYNTAX

show ethernet cfm configuration {**global** | **traps** | **interface** *interface*}

global – Displays global settings including CFM global status, cross-check start delay, and link trace parameters.

traps – Displays the status of all continuity check and cross-check traps.

interface – Displays CFM status for the specified interface.

ethernet *unit/port*

unit - Unit identifier. (Range: 1)

port - Port number. (Range: 1-28/52)

port-channel *channel-id* (Range: 1-16)

DEFAULT SETTING

None

COMMAND MODE

Privileged Exec

EXAMPLE

This example shows the global settings for CFM.

```
Console#show ethernet cfm configuration global
CFM Global Status      : Enabled
Crosscheck Start Delay : 10 seconds
Linktrace Cache Status : Enabled
Linktrace Cache Hold Time : 100 minutes
Linktrace Cache Size   : 100 entries
Console#
```

This example shows the configuration status for continuity check and cross-check traps.

```

Console#show ethernet cfm configuration traps
CC MEP Up Trap           :Disabled
CC MEP Down Trap        :Disabled
CC Configure Trap       :Disabled
CC Loop Trap            :Disabled
Cross Check MEP Unknown Trap :Disabled
Cross Check MEP Missing Trap :Disabled
Cross Check MA Up       :Disabled
Console#
    
```

Table 192: show ethernet cfm configuration traps - display description

Field	Description
CC MEP Up Trap	Sends a trap if a remote MEP is discovered and added to the local database, the port state of a previously discovered remote MEP changes, or a CCM is received from a remote MEP which as an expired entry in the archived database.
CC Mep Down Trap	Sends a trap if this device loses connectivity with a remote MEP, or connectivity has been restored to a remote MEP which has recovered from an error condition.
CC Configure Trap	Sends a trap if this device receives a CCM with the same MPID as its own but with a different source MAC address, indicating that a CFM configuration error exists.
CC Loop Trap	Sends a trap if this device receives a CCM with the same source MAC address and MPID as its own, indicating that a forwarding loop exists.
Cross Check MEP Unknown Trap	A CCM is received from a MEP that has not been configured as a DSAP (see the ethernet cfm mep command), manually configured as a remote MEP (see the mep crosscheck mpid command), nor learned through previous CCM messages.
Cross Check MEP Missing Trap	This device failed to receive three consecutive CCMs from another MEP in the same MA.
Cross Check MA Up	Generates a trap when all remote MEPs belonging to an MA come up.

This example shows the CFM status for port 1.

```

Console#show ethernet cfm configuration interface ethernet 1/1
Ethernet 1/1 CFM Status:Enabled
Console#
    
```

show ethernet cfm md This command displays the configured maintenance domains.

SYNTAX

show ethernet cfm md [level *level*]

level – Maintenance level. (Range: 0-7)

DEFAULT SETTING

None

COMMAND MODE

Privileged Exec

EXAMPLE

This example shows all configured maintenance domains.

```
Console#show ethernet cfm md
MD Index  MD Name          Level  MIP Creation  Archive Hold Time (m.)
-----
          1 rd              0  default              100
Console#
```

show ethernet cfm ma This command displays the configured maintenance associations.

SYNTAX

show ethernet cfm ma [level *level*]

level – Maintenance level. (Range: 0-7)

DEFAULT SETTING

None

COMMAND MODE

Privileged Exec

COMMAND USAGE

For a description of the values displayed in the CC Interval field, refer to the [ethernet cfm cc ma interval](#) command.

EXAMPLE

This example shows all configured maintenance associations.

```
Console#show ethernet cfm ma
MD Name      MA Index MA Name      Primary VID  CC Interval MIP Creation
-----
steve                1 voip                1             4 Default
Console#
```

show ethernet cfm maintenance-points local This command displays the maintenance points configured on this device.
SYNTAX

show ethernet cfm maintenance-points local

{**mep** [**domain** *domain-name* | **interface** *interface* | **level** *level-id*] | **mip** [**domain** *domain-name* | **level** *level-id*]}

mep – Displays only local maintenance end points.

mip – Displays only local maintenance intermediate points.

domain-name – Domain name. (Range: 1-43 alphanumeric characters)

interface – Displays CFM status for the specified interface.

ethernet *unit/port*

unit - Unit identifier. (Range: 1)

port - Port number. (Range: 1-28/52)

port-channel *channel-id* (Range: 1-16)

level-id – Maintenance level for this domain. (Range: 0-7)

DEFAULT SETTING

None

COMMAND MODE

Privileged Exec

COMMAND USAGE

- ◆ Use the **mep** keyword with this command to display the MEPs configured on this device as DSAPs through the [ethernet cfm mep](#) command.
- ◆ Using the **mip** keyword with this command to display the MIPs generated on this device by the CFM protocol when the mip-creation method is set to either "default" or "explicit" by the [ethernet cfm domain](#) command or the [ma index name](#) command.

EXAMPLE

This example shows all MEPs configured on this device for maintenance domain rd.

```

Console#show ethernet cfm maintenance-points local mep
MPID MD Name          Level Direct VLAN Port      CC Status MAC Address
-----
  1 rd                0 UP          1 Eth 1/ 1 Enabled  00-12-CF-3A-A8-C0
Console#

```

show ethernet cfm maintenance-points local detail mep This command displays detailed CFM information about a local MEP in the continuity check database.

SYNTAX

show ethernet cfm maintenance-points local detail mep
[**domain** *domain-name* | **interface** *interface* | **level** *level-id*]

domain-name – Domain name. (Range: 1-43 alphanumeric characters)

interface – Displays CFM status for the specified interface.

ethernet *unit/port*

unit - Unit identifier. (Range: 1)

port - Port number. (Range: 1-28/52)

port-channel *channel-id* (Range: 1-16)

level-id – Maintenance level for this domain. (Range: 0-7)

DEFAULT SETTING

None

COMMAND MODE

Privileged Exec

EXAMPLE

This example shows detailed information about the local MEP on port 1.

```
Console#show ethernet cfm maintenance-points local detail mep interface
 ethernet 1/1
MEP Settings:
-----
MPID                : 1
MD Name             : vopu
MA Name             : r&d
MA Name Format       : Character String
Level               : 0
Direction           : Up
Interface           : Eth 1/ 1
CC Status           : Enabled
MAC Address         : 00-E0-0C-00-00-FD
Defect Condition    : No Defect
Received RDI        : False
AIS Status          : Enabled
AIS Period          : 1 seconds
AIS Transmit Level  : Default
Suppress Alarm      : Disabled
Suppressing Alarms  : Disabled

Console#
```

Table 193: show ethernet cfm maintenance-points local detail mep - display

Field	Description
MPID	MEP identifier
MD Name	The maintenance domain for this entry.
MA Name	Maintenance association to which this remote MEP belongs
MA Name Format	The format of the Maintenance Association name, including Character String or ICC Based
Level	Maintenance level of the local maintenance point
Direction	The direction in which the MEP faces on the Bridge port (up or down).
Interface	The port to which this MEP is attached.
CC Status	Shows if the MEP will generate CCM messages.
MAC Address	MAC address of the local maintenance point. (If a CCM for the specified remote MEP has never been received or the local MEP record times out, the address will be set to the initial value of all Fs.)
Defect Condition	Shows the defect detected on the MEP.
Received RDI	Receive status of remote defect indication (RDI) messages on the MEP.
AIS Status	Shows if MEPs within the specified MA are enabled to send frames with AIS information following detection of defect conditions.
AIS Period	The interval at which AIS information is sent.
AIS Transmit Level	The maintenance level at which AIS information will be sent for the specified MEP.
Suppress Alarm	Shows if the specified MEP is configured to suppress sending frames containing AIS information following the detection of defect conditions.
Suppressing Alarms	Shows if the specified MEP is currently suppressing sending frames containing AIS information following the detection of defect conditions.

**show ethernet cfm
maintenance-points
remote detail**

This command displays detailed CFM information about a remote MEP in the continuity check database.

SYNTAX

show ethernet cfm maintenance-points remote detail

{**mac** *mac-address* | **mpid** *mpid*}
[**domain** *domain-name* | **level** *level-id* | **ma** *ma-name*]

mac-address – MAC address of a remote maintenance point. This address can be entered in either of the following formats: xx-xx-xx-xx-xx-xx or xxxxxxxxxxxx

mpid – Maintenance end point identifier. (Range: 1-8191)

domain-name – Domain name. (Range: 1-43 alphanumeric characters)

level-id – Authorized maintenance level for this domain. (Range: 0-7)

ma-name – Maintenance association name. (Range: 1-43 alphanumeric characters)

DEFAULT SETTING

None

COMMAND MODE

Privileged Exec

COMMAND USAGE

Use the **mpid** keyword with this command to display information about a specific maintenance point, or use the **mac** keyword to display information about all maintenance points that have the specified MAC address.

EXAMPLE

This example shows detailed information about the remote MEP designated by MPID 2.

```

Console#show ethernet cfm maintenance-points remote detail mpid 2
MAC Address           : 00-0D-54-FC-A2-73
Domain/Level         : voip / 3
MA Name              : rd
Primary VLAN         : 1
MPID                 : 2
Incoming Port        : Eth 1/ 2
CC Lifetime          : 645 seconds
Age of Last CC Message : 2 seconds
Frame Loss           : 137
CC Packet Statistics : 647/1
Port State           : Up
Interface State      : Up
Crosscheck Status    : Enabled

Console#
    
```

Table 194: show ethernet cfm maintenance-points remote detail - display

Field	Description
MAC Address	MAC address of the remote maintenance point. (If a CCM for the specified remote MEP has never been received or the remote MEP record times out, the address will be set to the initial value of all Fs.)
Domain/Level	Maintenance domain and level of the remote maintenance point
MA Name	Maintenance association to which this remote MEP belongs
Primary VLAN	VLAN to which this MEP belongs
MPID	MEP identifier
Incoming Port	Port to which this remote MEP is attached.
CC Lifetime	Length of time to hold messages about this MEP in the CCM database
Age of Last CC Message	Length of time the last CCM message about this MEP has been in the CCM database
Frame Loss	Percentage of transmitted frames lost
CC Packet Statistics (received/error)	The number of CCM packets received successfully and those with errors

Table 194: show ethernet cfm maintenance-points remote detail - display

Field	Description
Port State	Port states include: Up – The port is functioning normally. Blocked – The port has been blocked by the Spanning Tree Protocol. No port state – Either no CCM has been received, or no port status TLV was received in the last CCM.
Interface State	Interface states include: No Status – Either no CCM has been received, or no interface status TLV was received in the last CCM. Up – The interface is ready to pass packets. Down – The interface cannot pass packets. Testing – The interface is in some test mode. Unknown – The interface status cannot be determined for some reason. Dormant – The interface is not in a state to pass packets but is in a pending state, waiting for some external event. Not Present – Some component of the interface is missing. isLowerLayerDown – The interface is down due to state of the lower layer interfaces.
Crosscheck Status	Shows if crosscheck function has been enabled.

Continuity Check Operations

ethernet cfm cc ma interval This command sets the transmission delay between continuity check messages (CCMs). Use the **no** form to restore the default settings.

SYNTAX

ethernet cfm cc md *domain-name* **ma** *ma-name*
interval *interval-level*

no ethernet cfm cc ma *ma-name* **interval**

domain-name – Domain name. (Range: 1-43 alphanumeric characters)

ma-name – Maintenance association name. (Range: 1-43 alphanumeric characters)

interval-level – The transmission delay between connectivity check messages. The setting for this parameter is expressed as levels 4 through 7, which in turn map to specific intervals of time. (CCM lifetime field options: 4 - 1 second, 5 - 10 seconds, 6 - 1 minute, 7 - 10 minutes).

DEFAULT SETTING

4 (100 ms)

COMMAND MODE

Global Configuration

COMMAND USAGE

- ◆ CCMs provide a means to discover other MEPs and to detect connectivity failures in an MA. If any MEP fails to receive three consecutive CCMs from any other MEPs in its MA, a connectivity failure

is registered. The interval at which CCMs are issued should therefore be configured to detect connectivity problems in a timely manner, as dictated by the nature and size of the MA.

- ◆ The maintenance of a MIP CCM database by a MIP presents some difficulty for bridges carrying a large number of Service Instances, and for whose MEPs are issuing CCMs at a high frequency. For this reason, slower CCM transmission rates may have to be used.

EXAMPLE

This example sets the transmission delay for continuity check messages to level 7 (60 seconds).

```
Console(config)#ethernet cfm cc md voip ma rd interval 7
Console(config)#
```

RELATED COMMANDS

[ethernet cfm cc enable \(1368\)](#)

ethernet cfm cc enable This command enables the transmission of continuity check messages (CCMs) within a specified maintenance association. Use the **no** form to disable the transmission of these messages.

SYNTAX

[no] ethernet cfm cc enable md *domain-name* **ma** *ma-name*

domain-name – Domain name. (Range: 1-43 alphanumeric characters)

ma-name – Maintenance association name. (Range: 1-43 alphanumeric characters)

DEFAULT SETTING

Disabled

COMMAND MODE

Global Configuration

COMMAND USAGE

- ◆ CCMs are multicast periodically by a MEP in order to discover other MEPs in the same MA, and to assure connectivity to all other MEPs/MIPs in the MA.
- ◆ Each CCM received is checked to verify that the MEP identifier field sent in the message does not match its own MEPID, which would indicate a duplicate MEP or network loop. If these error types are not found, the CCM is stored in the MEP's local database until aged out.
- ◆ If a maintenance point fails to receive three consecutive CCMs from any other MEP in the same MA, a connectivity failure is registered.

- ◆ If a maintenance point receives a CCM with an invalid MEPID or MA level or an MA level lower than its own, a failure is registered which indicates a configuration error or cross-connect error (i.e., overlapping MAs).

EXAMPLE

This example enables continuity check messages for the specified maintenance association.

```
Console(config)#ethernet cfm cc enable md voip ma rd
Console(config)#
```

**snmp-server enable
traps ethernet cfm
cc**

This command enables SNMP traps for CFM continuity check events. Use the **no** form to disable these traps.

SYNTAX

[no] snmp-server enable traps ethernet cfm cc [config | loop | mep-down | mep-up]

config – Sends a trap if this device receives a CCM with the same MPID as its own but with a different source MAC address, indicating that a CFM configuration error exists.

loop – Sends a trap if this device receives a CCM with the same source MAC address and MPID as its own, indicating that a forwarding loop exists.

mep-down – Sends a trap if this device loses connectivity with a remote MEP, or connectivity has been restored to a remote MEP which has recovered from an error condition.

mep-up – Sends a trap if a remote MEP is discovered and added to the local database, the port state of a previously discovered remote MEP changes, or a CCM is received from a remote MEP which as an expired entry in the archived database.

DEFAULT SETTING

All continuity checks are enabled.

COMMAND MODE

Global Configuration

COMMAND USAGE

All mep-up traps are suppressed when cross-checking of MEPs is enabled because cross-check traps include more detailed status information.

EXAMPLE

This example enables SNMP traps for mep-up events.

```
Console(config)#snmp-server enable traps ethernet cfm cc mep-up  
Console(config)#
```

RELATED COMMANDS

[ethernet cfm mep crosscheck \(1375\)](#)

mep archive-hold-time

This command sets the time that data from a missing MEP is retained in the continuity check message (CCM) database before being purged. Use the **no** form to restore the default setting.

SYNTAX

mep archive-hold-time *hold-time*

hold-time – The time to retain data for a missing MEP.
(Range: 1-65535 minutes)

DEFAULT SETTING

100 minutes

COMMAND MODE

CFM Domain Configuration

COMMAND USAGE

A change to the hold time only applies to entries stored in the database after this command is entered.

EXAMPLE

This example sets the aging time for missing MEPs in the CCM database to 30 minutes.

```
Console(config)#ethernet cfm domain index 1 name voip level 3  
Console(config-ether-cfm)#mep archive-hold-time 30  
Console(config-ether-cfm)#
```

clear ethernet cfm maintenance-points remote

This command clears the contents of the continuity check database.

SYNTAX

clear ethernet cfm maintenance-points remote
[**domain** *domain-name* | **level** *level-id*]

domain-name – Domain name. (Range: 1-43 alphanumeric characters)

level-id – Maintenance level. (Range: 0-7)

DEFAULT SETTING

None

COMMAND MODE

Privileged Exec

COMMAND USAGE

Use this command without any keywords to clear all entries in the CCM database. Use the **domain** keyword to clear the CCM database for a specific domain, or the **level** keyword to clear it for a specific maintenance level.

EXAMPLE

```
Console#clear ethernet cfm maintenance-points remote domain voip
Console#
```

clear ethernet cfm errors This command clears continuity check errors logged for the specified maintenance domain or maintenance level.

SYNTAX

clear ethernet cfm errors [**domain** *domain-name* | **level** *level-id*]

domain-name – Domain name. (Range: 1-43 alphanumeric characters)

level-id – Maintenance level. (Range: 0-7)

DEFAULT SETTING

None

COMMAND MODE

Privileged Exec

COMMAND USAGE

Use this command without any keywords to clear all entries in the error database. Use the **domain** keyword to clear the error database for a specific domain, or the **level** keyword to clear it for a specific maintenance level.

EXAMPLE

```
Console#clear ethernet cfm errors domain voip
Console#
```

show ethernet cfm errors This command displays the CFM continuity check errors logged on this device.

SYNTAX

show ethernet cfm errors [**domain** *domain-name* | **level** *level-id*]

domain-name – Domain name. (Range: 1-43 alphanumeric characters)

level-id – Authorized maintenance level for this domain. (Range: 0-7)

DEFAULT SETTING

None

COMMAND MODE

Privileged Exec

EXAMPLE

```

Console#show ethernet cfm errors
Level VLAN MPID Interface Remote MAC          Reason          MA Name
-----
5      2      40 Eth 1/1  ab.2f.9c.00.05.01 LEAK            provider_1_2
Console#
    
```

Table 195: show ethernet cfm errors - display description

Field	Description
Level	Maintenance level associated with this entry.
VLAN	VLAN in which this error occurred.
MPID	Identifier of remote MEP.
Interface	Port at which the error was recorded
Remote MAC	MAC address of remote MEP.
Reason	Error types include: LEAK – MA x is associated with a specific VID list*, one or more of the VIDs in this MA can pass through the bridge port, no MEP is configured facing outward (down) on any bridge port for this MA, and some other MA y, at a higher maintenance level, and associated with at least one of the VID(s) also in MA x, does have a MEP configured on the bridge port. VIDS – MA x is associated with a specific VID list* on this MA on the bridge port, and some other MA y, associated with at least one of the VID(s) also in MA x, also has an Up MEP configured facing inward (up) on some bridge port. EXCESS_LEV – The number of different MD levels at which MIPs are to be created on this port exceeds the bridge's capabilities. OVERLAP_LEV – A MEP is created for one VID at one maintenance level, but a MEP is configured on another VID at an equivalent or higher level, exceeding the bridge's capabilities.
MA	The maintenance association for this entry.

* This definition is based on the IEEE 802.1ag standard. Current software for this switch only supports a single VLAN per MA. However, since it may interact with other devices which support multiple VLAN assignments per MA, this error message may be reported.

Cross Check Operations

ethernet cfm mep crosscheck start-delay This command sets the maximum delay that a device waits for remote MEPs to come up before starting the cross-check operation. Use the **no** form to restore the default setting.

SYNTAX

ethernet cfm mep crosscheck start-delay *delay*

delay – The time a device waits for remote MEPs to come up before the cross-check is started. (Range: 1-65535 seconds)

DEFAULT SETTING

30 seconds

COMMAND MODE

Global Configuration

COMMAND USAGE

- ◆ This command sets the delay that a device waits for a remote MEP to come up, and it starts cross-checking the list of statically configured remote MEPs in the local maintenance domain against the MEPs learned through CCMs.
- ◆ The cross-check start delay should be configured to a value greater than or equal to the continuity check message interval to avoid generating unnecessary traps.

EXAMPLE

This example sets the maximum delay before starting the cross-check process.

```
Console(config)#ethernet cfm mep crosscheck start-delay 60
Console(config)#
```

snmp-server enable traps ethernet cfm crosscheck This command enables SNMP traps for CFM continuity check events, in relation to the cross-check operations between statically configured MEPs and those learned via continuity check messages (CCMs). Use the **no** form to restore disable these traps.

SYNTAX

[no] snmp-server enable traps ethernet cfm crosscheck [ma-up | mep-missing | mep-unknown]

ma-up – Sends a trap when all remote MEPs in an MA come up.

mep-missing – Sends a trap if the cross-check timer expires and no CCMs have been received from a remote MEP configured in the static list.

mep-unknown – Sends a trap if an unconfigured MEP comes up.

DEFAULT SETTING

All continuity checks are enabled.

COMMAND MODE

Global Configuration

COMMAND USAGE

- ◆ For this trap type to function, cross-checking must be enabled on the required maintenance associations using the `ethernet cfm mep crosscheck` command.
- ◆ A mep-missing trap is sent if cross-checking is enabled (with the `ethernet cfm mep crosscheck` command), and no CCM is received for a remote MEP configured in the static list (with the `mep crosscheck mpid` command).
- ◆ A mep-unknown trap is sent if cross-checking is enabled, and a CCM is received from a remote MEP that is not configured in the static list.
- ◆ A ma-up trap is sent if cross-checking is enabled, and a CCM is received from all remote MEPs configured in the static list for this maintenance association.

EXAMPLE

This example enables SNMP traps for mep-unknown events detected in cross-check operations.

```
Console(config)#snmp-server enable traps ethernet cfm crosscheck mep-unknown  
Console(config)#
```

mep crosscheck mpid This command statically defines a remote MEP in a maintenance association. Use the **no** form to remove a remote MEP.

SYNTAX

[no] mep crosscheck mpid mpid ma ma-name

mpid – Identifier for a maintenance end point which exists on another CFM-enabled device within the same MA. (Range: 1-8191)

ma-name – Maintenance association name. (Range: 1-43 alphanumeric characters)

DEFAULT SETTING

No remote MEPs are configured.

COMMAND MODE

CFM Domain Configuration

COMMAND USAGE

- ◆ Use this command to statically configure remote MEPs that exist inside the maintenance association. These remote MEPs are used in the cross-check operation to verify that all endpoints in the specified MA are operational.
- ◆ Remote MEPs can only be configured with this command if domain service access points (DSAPs) have already been created with the [ethernet cfm mep](#) command at the same maintenance level and in the same MA. DSAPs are MEPs that exist on the edge of the domain, and act as primary service access points for end-to-end cross-check, loop-back, and link-trace functions.

EXAMPLE

This example defines a static MEP for the specified maintenance association.

```
Console(config)#ethernet cfm domain index 1 name voip level 3
Console(config-ether-cfm)#ma index 1 name rd vlan 1
Console(config-ether-cfm)#mep crosscheck mpid 2 ma rd
Console(config-ether-cfm)#
```

**ethernet cfm mep
crosscheck**

This command enables cross-checking between the static list of MEPs assigned to other devices within the same maintenance association and the MEPs learned through continuity check messages (CCMs). Use the **disable** keyword to stop the cross-check process.

SYNTAX

ethernet cfm mep crosscheck {**enable** | **disable**}
md *domain-name* **ma** *ma-name*

enable – Starts the cross-check process.

disable – Stops the cross-check process.

domain-name – Domain name. (Range: 1-43 alphanumeric characters)

ma-name – MA name. (Range: 1-43 alphanumeric characters)

DEFAULT SETTING

Disabled

COMMAND MODE

Privileged Exec

COMMAND USAGE

- ◆ Before using this command to start the cross-check process, first configure the remote MEPs that exist on other devices inside the maintenance association using the [mep crosscheck mpid](#) command. These remote MEPs are used in the cross-check operation to verify that all endpoints in the specified MA are operational.

- ◆ The cross-check process is disabled by default, and must be manually started using this command with the **enable** keyword.

EXAMPLE

This example enables cross-checking within the specified maintenance association.

```
Console#ethernet cfm mep crosscheck enable md voip ma rd
Console#
```

show ethernet cfm maintenance-points remote crosscheck

This command displays information about remote MEPs statically configured in a cross-check list.

SYNTAX

show ethernet cfm maintenance-points remote crosscheck
[**domain** *domain-name* | **mpid** *mpid*]

domain-name – Domain name. (Range: 1-43 alphanumeric characters)

mpid – Maintenance end point identifier. (Range: 1-8191)

DEFAULT SETTING

None

COMMAND MODE

Privileged Exec

EXAMPLE

This example shows all remote MEPs statically configured on this device.

```
Console#show ethernet cfm maintenance-points remote crosscheck
MPID  MA Name           Level  VLAN  MEP Up  Remote MAC
-----
    2  downtown             4      2   Yes    00-0D-54-FC-A2-73
Console#
```

Link Trace Operations

ethernet cfm linktrace cache

This command enables caching of CFM data learned through link trace messages. Use the **no** form to disable caching.

SYNTAX

[**no**] **ethernet cfm linktrace cache**

DEFAULT SETTING

Enabled

COMMAND MODE

Global Configuration

COMMAND USAGE

- ◆ A link trace message is a multicast CFM frame initiated by a MEP, and forwarded from MIP to MIP, with each MIP generating a link trace reply, up to the point at which the link trace message reaches its destination or can no longer be forwarded.
- ◆ Use this command to enable the link trace cache to store the results of link trace operations initiated on this device. Use the [ethernet cfm linktrace](#) command to transmit a link trace message.
- ◆ Link trace responses are returned from each MIP along the path and from the target MEP. Information stored in the cache includes the maintenance domain name, MA name, MEPID, sequence number, and TTL value.

EXAMPLE

This example enables link trace caching.

```
Console(config)#ethernet cfm linktrace cache
Console(config)#
```

**ethernet cfm
linktrace cache
hold-time**

This command sets the hold time for CFM link trace cache entries. Use the **no** form to restore the default setting.

SYNTAX

ethernet cfm linktrace cache hold-time *minutes*

minutes – The aging time for entries stored in the link trace cache.
(Range: 1-65535 minutes)

DEFAULT SETTING

100 minutes

COMMAND MODE

Global Configuration

COMMAND USAGE

Before setting the aging time for cache entries, the cache must first be enabled with the [ethernet cfm linktrace cache](#) command.

EXAMPLE

This example sets the aging time for entries in the link trace cache to 60 minutes.

```
Console(config)#ethernet cfm linktrace cache hold-time 60
Console(config)#
```

ethernet cfm linktrace cache size

This command sets the maximum size for the link trace cache. Use the **no** form to restore the default setting.

SYNTAX

ethernet cfm linktrace cache size *entries*

entries – The number of link trace responses stored in the link trace cache. (Range: 1-4095 entries)

DEFAULT SETTING

100 entries

COMMAND MODE

Global Configuration

COMMAND USAGE

- ◆ Before setting the cache size, the cache must first be enabled with the [ethernet cfm linktrace cache](#) command.
- ◆ If the cache reaches the maximum number of specified entries, or the size is set to a value less than the current number of stored entries, no new entries are added. To add additional entries, the cache size must first be increased with this command, or purged with the [clear ethernet cfm linktrace-cache](#) command.

EXAMPLE

This example limits the maximum size of the link trace cache to 500 entries.

```
Console(config)#ethernet cfm linktrace cache size 500
Console(config)#
```

ethernet cfm linktrace This command sends CFM link trace messages to the MAC address of a remote MEP.

SYNTAX

ethernet cfm linktrace {**dest-mep** *destination-mpid* | **src-mep** *source-mpid* {**dest-mep** *destination-mpid* | *mac-address*} | *mac-address*} **md** *domain-name* **ma** *ma-name* [**tvl** *number*]

destination-mpid – The identifier of a remote MEP that is the target of the link trace message. (Range: 1-8191)

source-mpid – The identifier of a source MEP that will send the link trace message. (Range: 1-8191)

mac-address – MAC address of a remote MEP that is the target of the link trace message. This address can be entered in either of the following formats: xx-xx-xx-xx-xx-xx or xxxxxxxxxxxx

domain-name – Domain name. (Range: 1-43 alphanumeric characters)

ma-name – Maintenance association name. (Range: 1-43 alphanumeric characters)

number – The time to live of the linktrace message. (Range: 1-255 hops)

DEFAULT SETTING

None

COMMAND MODE

Privileged Exec

COMMAND USAGE

- ◆ Link trace messages can be targeted to MEPs, not MIPs. Before sending a link trace message, be sure you have configured the target MEP for the specified MA.
- ◆ If the MAC address of target MEP has not been learned by any local MEP, then the linktrace may fail. Use the [show ethernet cfm maintenance-points remote crosscheck](#) command to verify that a MAC address has been learned for the target MEP.
- ◆ Link trace messages (LTMs) are sent as multicast CFM frames, and forwarded from MIP to MIP, with each MIP generating a link trace reply, up to the point at which the LTM reaches its destination or can no longer be forwarded.
- ◆ Link trace messages are used to isolate faults. However, this task can be difficult in an Ethernet environment, since each node is connected through multipoint links. Fault isolation is even more challenging since the MAC address of the target node can age out in several minutes. This can cause the traced path to vary over time, or connectivity lost if faults cause the target MEP to be isolated from other MEPs in an MA.

- ◆ When using the command line or web interface, the source MEP used by to send a link trace message is chosen by the CFM protocol. However, when using SNMP, the source MEP can be specified by the user.

EXAMPLE

This example sends a link trace message to the specified MEP with a maximum hop count of 25.

```
Console#linktrace ethernet dest-mep 2 md voip ma rd ttl 25
Console#
```

clear ethernet cfm linktrace-cache

This command clears link trace messages logged on this device.

COMMAND MODE
Privileged Exec

EXAMPLE

```
Console#clear ethernet cfm linktrace-cache
Console#
```

show ethernet cfm linktrace-cache

This command displays the contents of the link trace cache.

COMMAND MODE
Privileged Exec

EXAMPLE

```
Console#show ethernet cfm linktrace-cache
Hops MA          IP / Alias      Ingress MAC      Ing. Action Relay
          Forwarded      Egress MAC       Egr. Action
-----
  2 rd          192.168.0.6    00-12-CF-12-12-2D ingOk           Hit
          Not Forwarded
Console#
```

Table 196: show ethernet cfm linktrace-cache - display description

Field	Description
Hops	The number hops taken to reach the target MEP.
MA	Name of the MA to which this device belongs.
IP/Alias	IP address or alias of the target device's CPU.
Forwarded	Shows whether or not this link trace message was forwarded. A message is not forwarded if received by the target MEP.
Ingress MAC	MAC address of the ingress port on the target device.
Egress MAC	MAC address of the egress port on the target device.

Table 196: show ethernet cfm linktrace-cache - display description

Field	Description
Ing. Action	<p>Action taken on the ingress port:</p> <p>IngOk – The target data frame passed through to the MAC Relay Entity.</p> <p>IngDown – The bridge port’s MAC_Operational parameter is false. This value could be returned, for example, by an operationally Down MEP that has another Down MEP at a higher MD level on the same bridge port that is causing the bridge port’s MAC_Operational parameter to be false.</p> <p>IngBlocked – The ingress port can be identified, but the target data frame was not forwarded when received on this port due to active topology management, i.e., the bridge port is not in the forwarding state.</p> <p>IngVid – The ingress port is not in the member set of the LTM’s VIDs, and ingress filtering is enabled, so the target data frame was filtered by ingress filtering.</p>
Egr. Action	<p>Action taken on the egress port:</p> <p>EgrOk – The targeted data frame was forwarded.</p> <p>EgrDown – The Egress Port can be identified, but that bridge port’s MAC_Operational parameter is false.</p> <p>EgrBlocked – The egress port can be identified, but the data frame was not passed through the egress port due to active topology management, i.e., the bridge port is not in the forwarding state.</p> <p>EgrVid – The Egress Port can be identified, but the bridge port is not in the LTM’s VID member set, and was therefore filtered by egress filtering.</p>
Relay	<p>Relay action:</p> <p>FDB – Target address found in forwarding database.</p> <p>MPDB – Target address found in the maintenance point database.</p> <p>HIT – Target located on this device.</p>

Loopback Operations

ethernet cfm loopback This command sends CFM loopback messages to a MAC address for a MEP or MIP.

SYNTAX

ethernet cfm loopback {**dest-mep** *destination-mpid* | **src-mep** *source-mpid* {**dest-mep** *destination-mpid* | *mac-address*} | *mac-address*} **md** *domain-name* **ma** *ma-name* [**count** *transmit-count*] [**size** *packet-size*]

destination-mpid – The identifier of a MEP that is the target of the loopback message. (Range: 1-8191)

source-mpid – The identifier of a source MEP that will send the loopback message. (Range: 1-8191)

mac-address – MAC address of the remote maintenance point that is the target of the loopback message. This address can be entered in either of the following formats: xx-xx-xx-xx-xx-xx or xxxxxxxxxxxx

domain-name – Domain name. (Range: 1-43 alphanumeric characters)

ma-name – Maintenance association name. (Range: 1-43 alphanumeric characters)

transmit-count – The number of times the loopback message is sent. (Range: 1-1024)

packet-size – The size of the loopback message. (Range: 64-1518 bytes)

DEFAULT SETTING

Loop back count: One loopback message is sent.

Loop back size: 64 bytes

COMMAND MODE

Privileged Exec

COMMAND USAGE

- ◆ Use this command to test the connectivity between maintenance points. If the continuity check database does not have an entry for the specified maintenance point, an error message will be displayed.
- ◆ The point from which the loopback message is transmitted (i.e., the DSAP) and the target maintenance point specified in this command must be within the same MA.
- ◆ Loop back messages can be used for fault verification and isolation after automatic detection of a fault or receipt of some other error report. Loopback messages can also be used to confirm the successful restoration or initiation of connectivity. The receiving maintenance point should respond to the loop back message with a loopback reply.
- ◆ When using the command line or web interface, the source MEP used by to send a loopback message is chosen by the CFM protocol. However, when using SNMP, the source MEP can be specified by the user.

EXAMPLE

This example sends a loopback message to the specified remote MEP.

```
Console#ethernet cfm loopback dest-mep 1 md voip ma rd  
Console#
```

Fault Generator Operations

mep fault-notify alarm-time This command sets the time a defect must exist before a fault alarm is issued. Use the **no** form to restore the default setting.

SYNTAX

mep fault-notify alarm-time *alarm-time*

no fault-notify alarm-time

alarm-time – The time that one or more defects must be present before a fault alarm is generated. (Range: 3-10 seconds)

DEFAULT SETTING

3 seconds

COMMAND MODE

CFM Domain Configuration

COMMAND USAGE

A fault alarm is issued when the MEP fault notification generator state machine detects that a time period configured by this command has passed with one or more defects indicated, and fault alarms are enabled at or above the priority level set by the [mep fault-notify lowest-priority](#) command.

EXAMPLE

This example set the delay time before generating a fault alarm.

```
Console(config)#ethernet cfm domain index 1 name voip level 3
Console(config-ether-cfm)#mep fault-notify alarm-time 10
Console(config-ether-cfm)#
```

**mep fault-notify
lowest-priority**

This command sets the lowest priority defect that is allowed to generate a fault alarm. Use the **no** form to restore the default setting.

SYNTAX

mep fault-notify lowest-priority *priority*

no fault-notify lowest-priority

priority – Lowest priority default allowed to generate a fault alarm.
(Range: 1-6)

DEFAULT SETTING

Priority level 2

COMMAND MODE

CFM Domain Configuration

COMMAND USAGE

- ◆ A fault alarm can generate an SNMP notification. It is issued when the MEP fault notification generator state machine detects that a configured time period (see the [mep fault-notify alarm-time](#) command) has passed with one or more defects indicated, and fault alarms are enabled at or above the priority level set by this command. The state machine transmits no further fault alarms until it is reset by the passage of a configured time period (see the [mep fault-notify reset-time](#) command) without a defect indication. The normal procedure upon receiving a fault alarm is to inspect the reporting MEP's managed objects using an appropriate SNMP software tool, diagnose the fault, correct it, re-examine the MEP's managed objects to see whether the MEP fault

notification generator state machine has been reset, and repeat those steps until the fault is resolved.

- ◆ Only the highest priority defect currently detected is reported in the fault alarm.
- ◆ Priority defects include the following items:

Table 197: Remote MEP Priority Levels

Priority Level	Level Name	Description
1	allDef	All defects.
2	macRemErrXcon	DefMACstatus, DefRemoteCCM, DefErrorCCM, or DefXconCCM.
3	remErrXcon	DefErrorCCM, DefXconCCM or DefRemoteCCM.
4	errXcon	DefErrorCCM or DefXconCCM.
5	xcon	DefXconCCM
6	noXcon	No defects DefXconCCM or lower are to be reported.

Table 198: MEP Defect Descriptions

Field	Description
DefMACstatus	Either some remote MEP is reporting its Interface Status TLV as not isUp, or all remote MEPs are reporting a Port Status TLV that contains some value other than psUp.
DefRemoteCCM	The MEP is not receiving valid CCMs from at least one of the remote MEPs.
DefErrorCCM	The MEP has received at least one invalid CCM whose CCM Interval has not yet timed out.
DefXconCCM	The MEP has received at least one CCM from either another MAID or a lower MD Level whose CCM Interval has not yet timed out.

EXAMPLE

This example sets the lowest priority defect that will generate a fault alarm.

```
Console(config)#ethernet cfm domain index 1 name voip level 3
Console(config-ether-cfm)#mep fault-notify lowest-priority 1
Console(config-ether-cfm)#
```

mep fault-notify reset-time This command configures the time after a fault alarm has been issued, and no defect exists, before another fault alarm can be issued. Use the **no** form to restore the default setting.

SYNTAX

mep fault-notify reset-time *reset-time*

no fault-notify reset-time

reset-time – The time that must pass without any further defects indicated before another fault alarm can be generated.
(Range: 3-10 seconds)

DEFAULT SETTING

10 seconds

COMMAND MODE

CFM Domain Configuration

EXAMPLE

This example sets the reset time after which another fault alarm can be generated.

```
Console(config)#ethernet cfm domain index 1 name voip level 3
Console(config-ether-cfm)#mep fault-notify reset-time 7
Console(config-ether-cfm)#
```

show ethernet cfm fault-notify-generator This command displays configuration settings for the fault notification generator.

SYNTAX

show ethernet cfm fault-notify-generator mep *mpid*

mpid – Maintenance end point identifier. (Range: 1-8191)

DEFAULT SETTING

None

COMMAND MODE

Privileged Exec

EXAMPLE

This example shows the fault notification settings configured for one MEP.

```
Console#show ethernet cfm fault-notify-generator mep 1
MD Name      MA Name      Highest Defect Lowest Alarm  Alarm Time Reset Time
-----
          voip          rd none          macRemErrXcon    3sec.    10sec.
Console#
```

Table 199: show fault-notify-generator - display description

Field	Description
MD Name	The maintenance domain for this entry.
MA Name	The maintenance association for this entry.
Highest Defect	The highest defect that will generate a fault alarm. (This is disabled by default.)
Lowest Alarm	The lowest defect that will generate a fault alarm (see the mep fault-notify lowest-priority command).
Alarm Time	The time a defect must exist before a fault alarm is issued (see the mep fault-notify alarm-time , command).
Reset Time	The time after a fault alarm has been issued, and no defect exists, before another fault alarm can be issued (see the mep fault-notify reset-time command).

Delay Measure Operations

ethernet cfm delay-measure two-way This command sends periodic delay-measure requests to a specified MEP within a maintenance association.

SYNTAX

```
ethernet cfm delay-measure two-way [src-mep source-mpid]
  {dest-mep destination-mpid | mac-address} md domain-name
ma ma-name [count transmit-count] [interval interval]
[size packet-size] [timeout timeout]
```

source-mpid – The identifier of a source MEP that will send the delay-measure message. (Range: 1-8191)

destination-mpid – The identifier of a remote MEP that is the target of the delay-measure message. (Range: 1-8191)

mac-address – MAC address of a remote MEP that is the target of the delay-measure message. This address can be entered in either of the following formats: xx-xx-xx-xx-xx-xx or xxxxxxxxxxxx

domain-name – Domain name. (Range: 1-43 alphanumeric characters)

ma-name – Maintenance association name. (Range: 1-43 alphanumeric characters)

count – The number of times to retry sending the message if no response is received before the specified timeout. (Range: 1-5)

interval – The transmission delay between delay-measure messages. (Range: 1-5 seconds)

packet-size – The size of the delay-measure message. (Range: 64-1518 bytes)

timeout – The timeout to wait for a response. (Range: 1-5 seconds)

DEFAULT SETTING

Count: 5

Interval: 1 second

Size: 64 bytes
Timeout: 5 seconds

COMMAND MODE
Privileged Exec

COMMAND USAGE

- ◆ Delay measurement can be used to measure frame delay and frame delay variation between MEPs.
- ◆ A local MEP must be configured for the same MA before you can use this command.
- ◆ If a MEP is enabled to generate frames with delay measurement (DM) information, it periodically sends DM frames to its peer MEP in the same MA., and expects to receive DM frames back from it.
- ◆ Frame delay measurement can be made only for two-way measurements, where the MEP transmits a frame with DM request information with the TxTimeStampf (Timestamp at the time of sending a frame with DM request information), and the receiving MEP responds with a frame with DM reply information with TxTimeStampf copied from the DM request information, RxTimeStampf (Timestamp at the time of receiving a frame with DM request information), and TxTimestampb (Timestamp at the time of transmitting a frame with DM reply information):

$$\text{Frame Delay} = (\text{RxTimeStampb} - \text{TxTimeStampf}) - (\text{TxTimestampb} - \text{RxTimeStampf})$$
- ◆ The MEP can also make two-way frame delay variation measurements based on its ability to calculate the difference between two subsequent two-way frame delay measurements.

EXAMPLE

This example sends periodic delay-measure requests to a remote MEP.

```

Console#ethernet cfm delay-measure two-way dest-mep 1 md voip ma rd
Type ESC to abort.
Sending 5 Ethernet CFM delay measurement message, timeout is 5 sec.
Sequence  Delay Time (ms.)  Delay Variation (ms.)
-----  -
          1                < 10                0
          2                < 10                0
          3                < 10                0
          4                 40                40
          5                < 10                40
Success rate is 100% (5/5), delay time min/avg/max=0/8/40 ms.
Average frame delay variation is 16 ms.
Console#

```

The switch provides OAM (Operation, Administration, and Maintenance) remote management tools required to monitor and maintain the links to subscriber CPEs (Customer Premise Equipment). This section describes functions including enabling OAM for selected ports, loop back testing, and displaying device information.

Table 200: OAM Commands

Command	Function	Mode
<code>efm oam</code>	Enables OAM services	IC
<code>efm oam critical-link-event</code>	Enables reporting of critical event or dying gasp	IC
<code>efm oam link-monitor frame</code>	Enables reporting of errored frame link events	IC
<code>efm oam link-monitor frame threshold</code>	Sets the threshold for errored frame link events	IC
<code>efm oam link-monitor frame window</code>	Sets the monitor period for errored frame link events	IC
<code>efm oam mode</code>	Sets the OAM operational mode to active or passive	IC
<code>clear efm oam counters</code>	Clears statistical counters for various OAMPDU message types	PE
<code>clear efm oam event-log</code>	Clears all entries from the OAM event log for the specified port	PE
<code>efm oam remote-loopback</code>	Initiates or terminates remote loopback test	PE
<code>efm oam remote-loopback test</code>	Performs remote loopback test, sending a specified number of packets	PE
<code>show efm oam counters interface</code>	Displays counters for various OAM PDU message types	NE,PE
<code>show efm oam event-log interface</code>	Displays OAM event log	NE,PE
<code>show efm oam remote-loopback interface</code>	Displays results of OAM remote loopback test	NE,PE
<code>show efm oam status interface</code>	Displays OAM configuration settings and event counters	NE,PE
<code>show efm oam status remote interface</code>	Displays information about attached OAM-enabled devices	NE,PE

efm oam This command enables OAM functions on the specified port. Use the **no** form to disable this function.

SYNTAX

[no] efm oam

DEFAULT SETTING

Disabled

COMMAND MODE

Interface Configuration

COMMAND USAGE

- ◆ If the remote device also supports OAM, both exchange Information OAMPDUs to establish an OAM link.
- ◆ Not all CPEs support OAM functions, and OAM is therefore disabled by default. If the CPE attached to a port supports OAM, then this functionality must first be enabled by the **efm oam** command to gain access to other remote configuration functions.

EXAMPLE

```
Console(config)#interface ethernet 1/1
Console(config-if)#efm oam
Console(config-if)#
```

efm oam critical-link-event This command enables reporting of critical event or dying gasp. Use the **no** form to disable this function.

SYNTAX

[no] efm oam critical-link-event {critical-event | dying-gasp}

critical-event - If a critical event occurs, the local OAM entity (this switch) indicates this to its peer by setting the appropriate flag in the next OAMPDU to be sent and stores this information in its OAM event log.

dying-gasp - If an unrecoverable condition occurs, the local OAM entity indicates this by immediately sending a trap message.

DEFAULT SETTING

Enabled

COMMAND MODE

Interface Configuration

COMMAND USAGE

- ◆ Critical events are vendor-specific and may include various failures, such as abnormal voltage fluctuations, out-of-range temperature

detected, fan failure, CRC error in flash memory, insufficient memory, or other hardware faults.

- ◆ Dying gasp events are caused by an unrecoverable failure, such as a power failure or device reset.



NOTE: When system power fails, the switch will always send a dying gasp trap message prior to power down.

EXAMPLE

```
Console(config)#interface ethernet 1/1
Console(config-if)#efm oam critical-link-event dying-gasp
Console(config-if)#
```

efm oam link-monitor frame

This command enables reporting of errored frame link events. Use the **no** form to disable this function.

SYNTAX

[no] efm oam link-monitor frame

DEFAULT SETTING

Enabled

COMMAND MODE

Interface Configuration

COMMAND USAGE

- ◆ An errored frame is a frame in which one or more bits are errored.
- ◆ If this feature is enabled and an errored frame link event occurs, the local OAM entity (this switch) sends an Event Notification OAMPDU.

EXAMPLE

```
Console(config)#interface ethernet 1/1
Console(config-if)#efm oam link-monitor frame
Console(config-if)#
```

efm oam link-monitor frame threshold

This command sets the threshold for errored frame link events. Use the **no** form to restore the default setting.

SYNTAX

efm oam link-monitor frame threshold *count*

no efm oam link-monitor frame threshold

count - The threshold for errored frame link events.
(Range: 1-65535)

DEFAULT SETTING

1

COMMAND MODE

Interface Configuration

COMMAND USAGE

If this feature is enabled, an event notification message is sent if the threshold is reached or exceeded within the period specified by the [efm oam link-monitor frame window](#) command (page 1392). The Errored Frame Event TLV includes the number of errored frames detected during the specified period.

EXAMPLE

```
Console(config)#interface ethernet 1/1
Console(config-if)#efm oam link-monitor frame threshold 5
Console(config-if)#
```

efm oam link-monitor frame window

This command sets the monitor period for errored frame link events. Use the **no** form to restore the default setting.

SYNTAX

efm oam link-monitor frame window *size*

no efm oam link-monitor frame window

size - The period of time in which to check the reporting threshold for errored frame link events. (Range: 10-65535 units of 10 milliseconds)

DEFAULT SETTING

10 (units of 100 milliseconds) = 1 second

COMMAND MODE

Interface Configuration

COMMAND USAGE

If this feature is enabled, an event notification message is sent if the threshold specified by the [efm oam link-monitor frame threshold](#) command

(page 1392) is reached or exceeded within the period specified by this command. The Errored Frame Event TLV includes the number of errored frames detected during the specified period.

EXAMPLE

This example set the window size to 5 seconds.

```
Console(config)#interface ethernet 1/1
Console(config-if)#efm oam link-monitor frame window 50
Console(config-if)#
```

efm oam mode This command sets the OAM mode on the specified port. Use the **no** form to restore the default setting.

SYNTAX

efm oam mode {active | passive}

no efm oam mode

active - All OAM functions are enabled.

passive - All OAM functions are enabled, except for OAM discovery, and sending loopback control OAMPDUs.

DEFAULT SETTING

Active

COMMAND MODE

Interface Configuration

COMMAND USAGE

When set to active mode, the selected interface will initiate the OAM discovery process. When in passive mode, it can only respond to discovery messages.

EXAMPLE

```
Console(config)#interface ethernet 1/1
Console(config-if)#efm oam mode active
Console(config-if)#
```

clear efm oam counters This command clears statistical counters for various OAMPDU message types.

SYNTAX

clear efm oam counters [*interface-list*]

interface-list - *unit/port*

unit - Unit identifier. (Range: 1)

port - Port number or list of ports. To enter a list, separate nonconsecutive port identifiers with a comma and no spaces; use a hyphen to designate a range of ports. (Range: 1-28/52)

COMMAND MODE

Privileged Exec

EXAMPLE

```
Console#clear efm oam counters
Console#
```

RELATED COMMANDS

[show efm oam counters interface \(1397\)](#)

clear efm oam event-log This command clears all entries from the OAM event log for the specified port.

SYNTAX

clear efm oam event-log [*interface-list*]

unit - Unit identifier. (Range: 1)

port - Port number or list of ports. To enter a list, separate nonconsecutive port identifiers with a comma and no spaces; use a hyphen to designate a range of ports. (Range: 1-28/52)

COMMAND MODE

Privileged Exec

EXAMPLE

```
Console#clear efm oam event-log
Console#
```

efm oam remote-loopback This command starts or stops OAM loopback test mode to the attached CPE.

SYNTAX

efm oam remote-loopback {**start** | **stop**} *interface*

start - Starts remote loopback test mode.

stop - Stops remote loopback test mode.

interface - *unit/port*

unit - Unit identifier. (Range: 1)

port - Port number. (Range: 1-28/52)

DEFAULT SETTING

None

COMMAND MODE

Privileged Exec

COMMAND USAGE

- ◆ OAM remote loop back can be used for fault localization and link performance testing. Statistics from both the local and remote DTE can be queried and compared at any time during loop back testing.
- ◆ Use the **efm oam remote-loopback start** command to start OAM remote loop back test mode on the specified port. Afterwards, use the [efm oam remote-loopback test](#) command (page 1396) to start sending test packets. Then use the **efm oam remote loopback stop** command to terminate testing (if test packets are still being sent) and to terminate loop back test mode.
- ◆ The port that you specify to run this test must be connected to a peer OAM device capable of entering into OAM remote loopback mode. During a remote loopback test, the remote OAM entity loops back every frame except for OAMPDUs and pause frames.
- ◆ During loopback testing, both the switch and remote device are permitted to send OAMPDUs to the peer device and to process any OAMPDUs received from the peer.

EXAMPLE

```

Console#efm oam remote-loopback start 1/1
Loopback operation is processing, please wait.
Enter loopback mode succeeded.
Console#

```

efm oam remote-loopback test This command performs a remote loopback test, sending a specified number of packets.

SYNTAX

efm oam remote-loopback test *interface* [*number-of-packets* [*packet-size*]]

interface - *unit/port*

unit - Unit identifier. (Range: 1)

port - Port number. (Range: 1-28/52)

number-of-packets - Number of packets to send. (Range: 1-99999999)

packet-size - Size of packets to send. (Range: 64-1518 bytes)

DEFAULT SETTING

Number of packets: 10,000

Packet size: 64 bytes

COMMAND MODE

Privileged Exec

COMMAND USAGE

- ◆ You can use this command to perform an OAM remote loopback test on the specified port. The port that you specify to run this test must be connected to a peer OAM device capable of entering into OAM remote loopback mode. During a remote loopback test, the remote OAM entity loops back every frame except for OAMPDUs and pause frames.
- ◆ OAM remote loopback can be used for fault localization and link performance testing. Statistics from both the local and remote DTE can be queried and compared at any time during loopback testing.
- ◆ A summary of the test is displayed after it is finished.

EXAMPLE

```

Console#efm oam remote-loopback test 1/1
Loopback test is processing, press ESC to suspend.
....
Port OAM loopback Tx OAM loopback Rx Loss Rate
-----
1/2          1990          1016    48.94 %
Console#

```

show efm oam counters interface This command displays counters for various OAM PDU message types.

SYNTAX

show efm oam counters interface [*interface-list*]

interface-list - *unit/port*

unit - Unit identifier. (Range: 1)

port - Port number or list of ports. To enter a list, separate nonconsecutive port identifiers with a comma and no spaces; use a hyphen to designate a range of ports. (Range: 1-28/52)

COMMAND MODE

Normal Exec, Privileged Exec

EXAMPLE

```

Console#show efm oam counters interface 1/1
Port OAMPDU Type          TX          RX
-----
1/1  Information            1121        1444
1/1  Event Notification      0           0
1/1  Loopback Control        1           0
1/1  Organization Specific 76           0
Console#

```

show efm oam event-log interface This command displays the OAM event log for the specified port(s) or for all ports that have logs.

show efm oam event-log interface [*interface-list*]

interface-list - *unit/port*

unit - Unit identifier. (Range: 1)

port - Port number or list of ports. To enter a list, separate nonconsecutive port identifiers with a comma and no spaces; use a hyphen to designate a range of ports. (Range: 1-28/52)

COMMAND MODE

Normal Exec, Privileged Exec

COMMAND USAGE

- ◆ When a link event occurs, no matter whether the location is local or remote, this information is entered in the OAM event log.
- ◆ When the log system becomes full, older events are automatically deleted to make room for new entries.

EXAMPLE

```

Console#show efm oam event-log interface 1/1
OAM event log of Eth 1/1:
 00:24:07 2001/01/01
  "Unit 1, Port 1: Dying Gasp at Remote"
Console#

```

This command can show OAM link status changes for link partner as shown in this example.

```

Console#show efm oam event-log interface 1/1
OAM event log of Eth 1/1:
 10:22:55 2013/09/13
  "Unit 1, Port 1: Connection to remote device is up at Local"
 10:22:44 2013/09/13
  "Unit 1, Port 1: Connection to remote device is down at Local"
  <--- When the link is down,this event will be written to OAM event-log
 10:20:02 2013/09/13
  "Unit 1, Port 1: Connection to remote device is up at Local"
  <--- When the link is up,this event will be written to OAM event-log,
Console#clear efm oam event-log
  <--- Use he "clear efm oam event-log" command to clear the event-log.
Console#show efm oam event-log interface 1/1
Console#

```

This command can show OAM dying gasp changes for link partner as shown in this example.

```

Console#show efm oam event-log interface 1/1
  <--- When dying gasp happens and the switch get these packets, it will log
  this event in OAM event-log.
OAM event log of Eth 1/1:
 10:27:21 2013/09/13
  "Unit 1, Port 1: Connection to remote device is down at Local"
 10:27:20 2013/09/13
  "Unit 1, Port 1: Dying Gasp occurred at Remote"
Console#show efm oam event-log interface 1/1
OAM event log of Eth 1/1:
 10:28:31 2013/09/13
  "Unit 1, Port 1: Connection to remote device is up at Local"
 10:28:28 2013/09/13
  "Unit 1, Port 1: Dying Gasp clear occurred at Remote"
  <--- When the remote device comes up, the switch will get OAM packets
  without the dying gasp bit and display "dying gasp event clear".
Console#

```

show efm oam remote-loopback interface This command displays the results of an OAM remote loopback test.
SYNTAX

show efm oam remote-loopback interface [*interface-list*]

interface-list - *unit/port*

unit - Unit identifier. (Range: 1)

port - Port number or list of ports. To enter a list, separate nonconsecutive port identifiers with a comma and no spaces; use a hyphen to designate a range of ports. (Range: 1-28/52)

COMMAND MODE

Normal Exec, Privileged Exec

EXAMPLE

```
Console#show efm oam remote-loopback interface 1/1
Port OAM loopback Tx OAM loopback Rx Loss Rate
-----
1/1          10000          9999    0.01 %
Console#
```

show efm oam status interface This command displays OAM configuration settings and event counters.

SYNTAX

show efm oam status interface [*interface-list*] [**brief**]

interface - *unit/port*

unit - Unit identifier. (Range: 1)

port - Port number or list of ports. To enter a list, separate nonconsecutive port identifiers with a comma and no spaces; use a hyphen to designate a range of ports. (Range: 1-28/52)

brief - Displays a brief list of OAM configuration states.

COMMAND MODE

Normal Exec, Privileged Exec

EXAMPLE

```
Console#show efm oam status interface 1/1
OAM information of Eth 1/1:
Basic Information:
Admin State           : Enabled
Operation State       : Operational
Mode                  : Active
Remote Loopback       : Disabled
Remote Loopback Status : No loopback
Dying Gasp            : Enabled
Critical Event        : Enabled
Link Monitor (Errored Frame) : Enabled
```

```

Link Monitor:
  Errored Frame Window (100msec) : 10
  Errored Frame Threshold       : 1
Console#show efm oam status interface 1/1 brief
$ = local OAM in loopback
* = remote OAM in loopback

Port Admin  Mode    Remote  Dying  Critical Errored
  State      Mode    Loopback Gasp   Event   Frame
-----
1/1  Enabled Active  Disabled Enabled Enabled  Enabled
Console#

```

show efm oam status remote interface This command displays information about attached OAM-enabled devices.

SYNTAX

show efm oam status remote interface [*interface-list*]

interface-list - unit/port

unit - Unit identifier. (Range: 1)

port - Port number or list of ports. To enter a list, separate nonconsecutive port identifiers with a comma and no spaces; use a hyphen to designate a range of ports. (Range: 1-28/52)

COMMAND MODE

Normal Exec, Privileged Exec

EXAMPLE

```

Console#show efm oam status remote interface 1/1
Port MAC Address      OUI    Remote  Unidirectional Link  MIB Variable
  Address             OUI    Loopback Unidirectional Monitor Retrieval
-----
1/1  00-12-CF-6A-07-F6  000084 Enabled  Disabled      Enabled Disabled
Console#

```

These commands are used to configure Domain Naming System (DNS) services. Entries can be manually configured in the DNS domain name to IP address mapping table, default domain names configured, or one or more name servers specified to use for domain name to address translation.

Note that domain name services will not be enabled until at least one name server is specified with the `ip name-server` command and domain lookup is enabled with the `ip domain-lookup` command.

Table 201: Address Table Commands

Command	Function	Mode
<code>ip domain-list</code>	Defines a list of default domain names for incomplete host names	GC
<code>ip domain-lookup</code>	Enables DNS-based host name-to-address translation	GC
<code>ip domain-name</code>	Defines a default domain name for incomplete host names	GC
<code>ip host</code>	Creates a static IPv4 host name-to-address mapping	GC
<code>ip name-server</code>	Specifies the address of one or more name servers to use for host name-to-address translation	GC
<code>ipv6 host</code>	Creates a static IPv6 host name-to-address mapping	GC
<code>clear dns cache</code>	Clears all entries from the DNS cache	PE
<code>clear host</code>	Deletes entries from the host name-to-address table	PE
<code>show dns</code>	Displays the configuration for DNS services	PE
<code>show dns cache</code>	Displays entries in the DNS cache	PE
<code>show hosts</code>	Displays the static host name-to-address mapping table	PE

ip domain-list This command defines a list of domain names that can be appended to incomplete host names (i.e., host names passed from a client that are not formatted with dotted notation). Use the **no** form to remove a name from this list.

SYNTAX

[no] ip domain-list name

name - Name of the host. Do not include the initial dot that separates the host name from the domain name.
(Range: 1-68 characters)

DEFAULT SETTING

None

COMMAND MODE

Global Configuration

COMMAND USAGE

- ◆ Domain names are added to the end of the list one at a time.
- ◆ When an incomplete host name is received by the DNS service on this switch, it will work through the domain list, appending each domain name in the list to the host name, and checking with the specified name servers for a match.
- ◆ If there is no domain list, the domain name specified with the `ip domain-name` command is used. If there is a domain list, the default domain name is not used.

EXAMPLE

This example adds two domain names to the current list and then displays the list.

```

Console(config)#ip domain-list sample.com.jp
Console(config)#ip domain-list sample.com.uk
Console(config)#end
Console#show dns
Domain Lookup Status:
    DNS Disabled
Default Domain Name:
    sample.com
Domain Name List:
    sample.com.jp
    sample.com.uk
Name Server List:
Console#

```

RELATED COMMANDS[ip domain-name \(1403\)](#)

ip domain-lookup This command enables DNS host name-to-address translation. Use the **no** form to disable DNS.

SYNTAX

[no] ip domain-lookup

DEFAULT SETTING

Disabled

COMMAND MODE

Global Configuration

COMMAND USAGE

- ◆ At least one name server must be specified before DNS can be enabled.

- ◆ If all name servers are deleted, DNS will automatically be disabled.

EXAMPLE

This example enables DNS and then displays the configuration.

```

Console(config)#ip domain-lookup
Console(config)#end
Console#show dns
Domain Lookup Status:
    DNS Enabled
Default Domain Name:
    sample.com
Domain Name List:
    sample.com.jp
    sample.com.uk
Name Server List:
    192.168.1.55
    10.1.0.55
Console#

```

RELATED COMMANDS

[ip domain-name \(1403\)](#)

[ip name-server \(1405\)](#)

ip domain-name This command defines the default domain name appended to incomplete host names (i.e., host names passed from a client that are not formatted with dotted notation). Use the **no** form to remove the current domain name.

SYNTAX

ip domain-name *name*

no ip domain-name

name - Name of the host. Do not include the initial dot that separates the host name from the domain name.
(Range: 1-127 characters)

DEFAULT SETTING

None

COMMAND MODE

Global Configuration

EXAMPLE

```

Console(config)#ip domain-name sample.com
Console(config)#end
Console#show dns
Domain Lookup Status:
    DNS Disabled
Default Domain Name:
    sample.com
Domain Name List:

```

```
Name Server List:
Console#
```

RELATED COMMANDS

[ip domain-list \(1401\)](#)

[ip name-server \(1405\)](#)

[ip domain-lookup \(1402\)](#)

ip host This command creates a static entry in the DNS table that maps a host name to an IPv4 address. Use the **no** form to remove an entry.

SYNTAX

[no] ip host *name address*

name - Name of an IPv4 host. (Range: 1-100 characters)

address - Corresponding IPv4 address.

DEFAULT SETTING

No static entries

COMMAND MODE

Global Configuration

COMMAND USAGE

Use the **no ip host** command to clear static entries, or the [clear host](#) command to clear dynamic entries.

EXAMPLE

This example maps an IPv4 address to a host name.

```
Console(config)#ip host rd5 192.168.1.55
Console(config)#end
Console#show hosts
No.  Flag Type      IP Address          TTL   Domain
-----
   0   2 Address 192.168.1.55          rd5
Console#
```

ip name-server This command specifies the address of one or more domain name servers to use for name-to-address resolution. Use the **no** form to remove a name server from this list.

SYNTAX

```
[no] ip name-server server-address1 [server-address2 ...
server-address6]
```

server-address1 - IPv4 or IPv6 address of domain-name server.
server-address2 ... server-address6 - IPv4 or IPv6 address of additional domain-name servers.

DEFAULT SETTING

None

COMMAND MODE

Global Configuration

COMMAND USAGE

The listed name servers are queried in the specified sequence until a response is received, or the end of the list is reached with no response.

EXAMPLE

This example adds two domain-name servers to the list and then displays the list.

```
Console(config)#ip name-server 192.168.1.55 10.1.0.55
Console(config)#end
Console#show dns
Domain Lookup Status:
  DNS disabled
Default Domain Name:
  sample.com
Domain Name List:
  sample.com.jp
  sample.com.uk
Name Server List:
  192.168.1.55
  10.1.0.55
Console#
```

RELATED COMMANDS

[ip domain-name \(1403\)](#)

[ip domain-lookup \(1402\)](#)

ipv6 host This command creates a static entry in the DNS table that maps a host name to an IPv6 address. Use the **no** form to remove an entry.

SYNTAX

[no] ipv6 host name ipv6-address

name - Name of an IPv6 host. (Range: 1-100 characters)

ipv6-address - Corresponding IPv6 address. This address must be entered according to RFC 2373 "IPv6 Addressing Architecture," using 8 colon-separated 16-bit hexadecimal values. One double colon may be used in the address to indicate the appropriate number of zeros required to fill the undefined fields.

DEFAULT SETTING

No static entries

COMMAND MODE

Global Configuration

EXAMPLE

This example maps an IPv6 address to a host name.

```

Console(config)#ipv6 host rd6 2001:0db8:1::12
Console(config)#end
Console#show hosts
No.  Flag Type      IP Address      TTL      Domain
-----
  0   2  Address 192.168.1.55
  1   2  Address 2001:DB8:1::12
Console#

```

clear dns cache This command clears all entries in the DNS cache.

COMMAND MODE

Privileged Exec

EXAMPLE

```

Console#clear dns cache
Console#show dns cache
No.  Flag Type      IP Address      TTL      Domain
-----
Console#

```

clear host This command deletes dynamic entries from the DNS table.

SYNTAX

clear host {*name* | *}

name - Name of the host. (Range: 1-100 characters)

* - Removes all entries.

DEFAULT SETTING

None

COMMAND MODE

Privileged Exec

COMMAND USAGE

Use the **clear host** command to clear dynamic entries, or the [no ip host](#) command to clear static entries.

EXAMPLE

This example clears all dynamic entries from the DNS table.

```
Console(config)#clear host *
Console(config)#
```

show dns This command displays the configuration of the DNS service.

COMMAND MODE

Privileged Exec

EXAMPLE

```
Console#show dns
Domain Lookup Status:
  DNS enabled
Default Domain Name:
  sample.com
Domain Name List:
  sample.com.jp
  sample.com.uk
Name Server List:
  192.168.1.55
  10.1.0.55
Console#
```

show dns cache This command displays entries in the DNS cache.

COMMAND MODE
Privileged Exec

EXAMPLE

```

Console#show dns cache
No.      Flag  Type  IP Address      TTL  Domain
-----
      3    4 Host  209.131.36.158  115  www-real.wal.b.yahoo.com
      4    4 CNAME POINTER TO:3    115  www.yahoo.com
      5    4 CNAME POINTER TO:3    115  www.wal.b.yahoo.com
Console#

```

Table 202: show dns cache - display description

Field	Description
No.	The entry number for each resource record.
Flag	The flag is always "4" indicating a cache entry and therefore unreliable.
Type	This field includes "Host" which specifies the primary name for the owner, and "CNAME" which specifies multiple domain names (or aliases) which are mapped to the same IP address as an existing entry.
IP Address	The IP address associated with this record.
TTL	The time to live reported by the name server.
Domain	The host name associated with this record.

show hosts This command displays the static host name-to-address mapping table.

COMMAND MODE
Privileged Exec

EXAMPLE

Note that a host name will be displayed as an alias if it is mapped to the same address(es) as a previously configured entry.

```

Console#show hosts
No.  Flag Type  IP Address      TTL  Domain
-----
  0   2 Address 192.168.1.55      rd5
  1   2 Address 2001:DB8:1::12    rd6
  3   4 Address 209.131.36.158    65  www-real.wal.b.yahoo.com
  4   4 CNAME  POINTER TO:3      65  www.yahoo.com
  5   4 CNAME  POINTER TO:3      65  www.wal.b.yahoo.com
Console#

```

Table 203: show hosts - display description

Field	Description
No.	The entry number for each resource record.
Flag	The field displays "2" for a static entry, or "4" for a dynamic entry stored in the cache.
Type	This field includes "Address" which specifies the primary name for the owner, and "CNAME" which specifies multiple domain names (or aliases) which are mapped to the same IP address as an existing entry.
IP Address	The IP address associated with this record.
TTL	The time to live reported by the name server. This field is always blank for static entries.
Domain	The domain name associated with this record.

These commands are used to configure Dynamic Host Configuration Protocol (DHCP) client and relay functions. Any VLAN interface on this switch can be configured to automatically obtain an IP address through DHCP. This switch can also be configured to relay DHCP client configuration requests to a DHCP server on another network.

Table 204: DHCP Commands

Command Group	Function
DHCP Client	Allows interfaces to dynamically acquire IP address information
DHCP Relay	Relays DHCP requests from local hosts to a remote DHCP server

DHCP CLIENT

Use the commands in this section to allow the switch's VLAN interfaces to dynamically acquire IP address information.

Table 205: DHCP Client Commands

Command	Function	Mode
<i>DHCP for IPv4</i>		
<code>ip dhcp client class-id</code>	Specifies the DHCP client identifier for an interface	IC
<code>ip dhcp restart client</code>	Submits a BOOTP or DHCP client request	PE
<i>DHCP for IPv6</i>		
<code>ipv6 dhcp client rapid-commit vlan</code>	Specifies the Rapid Commit option for DHCPv6 message exchange	GC
<code>ipv6 dhcp restart client vlan</code>	Submits a DHCPv6 client request	PE
<code>show ipv6 dhcp duid</code>	Shows the DHCP Unique Identifier for this switch	PE
<code>show ipv6 dhcp vlan</code>	Shows DHCPv6 information for specified interface	PE

DHCP for IPv4

ip dhcp client class-id This command specifies the DHCP client vendor class identifier for the current interface. Use the **no** form to remove the class identifier from the DHCP packet.

SYNTAX

ip dhcp client class-id [**text** *text* | **hex** *hex*]

no ip dhcp client class-id

text - A text string. (Range: 1-32 characters)

hex - A hexadecimal value. (Range: 1-64 characters)

DEFAULT SETTING

Class identifier option enabled, and the default string is the unit model number

COMMAND MODE

Interface Configuration (VLAN)

COMMAND USAGE

- ◆ Use this command without a keyword to restore the default setting.
- ◆ This command is used to identify the vendor class and configuration of the switch to the DHCP server, which then uses this information to decide on how to service the client or the type of information to return.
- ◆ The general framework for this DHCP option is set out in RFC 2132 (Option 60). This information is used to convey configuration settings or other identification information about a client, but the specific string to use should be supplied by your service provider or network administrator. Options 60, 66 and 67 statements can be added to the server daemon's configuration file.

Table 206: Options 60, 66 and 67 Statements

Option	Statement	
	Keyword	Parameter
60	vendor-class-identifier	a string indicating the vendor class identifier
66	tftp-server-name	a string indicating the tftp server name
67	bootfile-name	a string indicating the bootfile name

- ◆ By default, DHCP option 66/67 parameters are not carried in a DHCP server reply. To ask for a DHCP reply with option 66/67 information, the DHCP client request sent by this switch includes a "parameter request list" asking for this information. Besides, the client request also includes a "vendor class identifier" set by the **ip dhcp client class-id** command that allows the DHCP server to identify the device, and select the appropriate configuration file for download. This information is included in Option 55 and 124.

Table 207: Options 55 and 124 Statements

Option	Statement	
	Keyword	Parameter
55	dhcp-parameter-request-list	a list of parameters, separated by ','
124	vendor-class-identifier	a string indicating the vendor class identifier

- ◆ The server should reply with Option 66 attributes, including the TFTP server name and boot file name.
- ◆ Note that the vendor class identifier can be formatted in either text or hexadecimal using the **ip dhcp client class-id** command, but the format used by both the client and server must be the same.

EXAMPLE

```

Console(config)#interface vlan 2
Console(config-if)#ip dhcp client class-id hex 0000e8666572
Console(config-if)#

```

RELATED COMMANDS

[ip dhcp restart client \(1413\)](#)

ip dhcp restart client This command submits a BOOTP or DHCP client request.

DEFAULT SETTING

None

COMMAND MODE

Privileged Exec

COMMAND USAGE

- ◆ This command issues a BOOTP or DHCP client request for any IP interface that has been set to BOOTP or DHCP mode through the [ip address](#) command.
- ◆ DHCP requires the server to reassign the client's last address if available.
- ◆ If the BOOTP or DHCP server has been moved to a different domain, the network portion of the address provided to the client will be based on this new domain.

EXAMPLE

In the following example, the device is reassigned the same address.

```
Console(config)#interface vlan 1
Console(config-if)#ip address dhcp
Console(config-if)#exit
Console#ip dhcp restart client
Console#show ip interface
VLAN 1 is Administrative Up - Link Up
  Address is 70-72-CF-94-22-34
  Index: 1001, MTU: 1500
  Address Mode is DHCP
  IP Address: 192.168.0.5 Mask: 255.255.255.0
  Proxy ARP is disabled
  DHCP relay server: 0.0.0.0
Console#
```

RELATED COMMANDS

[ip address \(1422\)](#)

DHCP for IPv6

ipv6 dhcp client rapid-commit vlan

This command specifies the Rapid Commit option for DHCPv6 message exchange for all DHCPv6 client requests submitted from the specified interface. Use the **no** form to disable this option.

SYNTAX

[no] ipv6 dhcp client rapid-commit vlan *vlan-id*

vlan-id - VLAN ID, specified as a single number, a range of consecutive numbers separated by a hyphen, or multiple numbers separated by commas. (Range: 1-4094; Maximum command length: 300 characters)

DEFAULT SETTING

Disabled

COMMAND MODE

Global Configuration

COMMAND USAGE

- ◆ DHCPv6 clients can obtain configuration parameters from a server through a normal four-message exchange (solicit, advertise, request, reply), or through a rapid two-message exchange (solicit, reply). The rapid-commit option must be enabled on both client and server for the two-message exchange to be used.
- ◆ This command allows two-message exchange method for prefix delegation. When enabled, DHCPv6 client requests submitted from the specified interface will include the rapid commit option in all solicit messages.

EXAMPLE

```
Console(config)#ipv6 dhcp client rapid-commit vlan 2
Console(config)#
```

ipv6 dhcp restart client vlan This command submits a DHCPv6 client request.

SYNTAX**ipv6 dhcp restart client vlan *vlan-id***

vlan-id - VLAN ID, specified as a single number, a range of consecutive numbers separated by a hyphen, or multiple numbers separated by commas. (Range: 1-4094; Maximum command length: 300 characters)

DEFAULT SETTING

None

COMMAND MODE

Privileged Exec

COMMAND USAGE

- ◆ This command starts the DHCPv6 client process if it is not yet running by submitting requests for configuration information through the specified interface(s). When DHCPv6 is restarted, the switch may attempt to acquire an IP address prefix through stateful address auto-configuration. If the router advertisements have the "other stateful configuration" flag set, the switch may also attempt to acquire other non-address configuration information (such as a default gateway or DNS server) when DHCPv6 is restarted.

Prior to submitting a client request to a DHCPv6 server, the switch should be configured with a link-local address using the [ipv6 address autoconfig](#) command. The state of the Managed Address Configuration flag (M flag) and Other Stateful Configuration flag (O flag) received in Router Advertisement messages will determine the information this switch should attempt to acquire from the DHCPv6 server as described below.

- Both M and O flags are set to 1:
DHCPv6 is used for both address and other configuration settings.
This combination is known as DHCPv6 stateful, in which a DHCPv6 server assigns stateful addresses to IPv6 hosts.
- The M flag is set to 0, and the O flag is set to 1:
DHCPv6 is used only for other configuration settings.
Neighboring routers are configured to advertise non-link-local address prefixes from which IPv6 hosts derive stateless addresses.

This combination is known as DHCPv6 stateless, in which a DHCPv6 server does not assign stateful addresses to IPv6 hosts, but does assign stateless configuration settings.

- ◆ DHCPv6 clients build a list of servers by sending a solicit message and collecting advertised message replies. These servers are then ranked based on their advertised preference value. If the client needs to acquire prefixes from servers, only servers that have advertised prefixes are considered.
- ◆ If the rapid commit option has been enabled on the switch using the `ipv6 dhcp client rapid-commit vlan` command, and on the DHCPv6 server, message exchange can be reduced from the normal four step process to a two-step exchange of only solicit and reply messages.

EXAMPLE

The following command submits a client request on VLAN 1.

```
Console#ipv6 dhcp restart client vlan 1
Console#
```

RELATED COMMANDS

[ipv6 address autoconfig \(1435\)](#)

show ipv6 dhcp duid

This command shows the DHCP Unique Identifier for this switch.

COMMAND MODE

Privileged Exec

COMMAND USAGE

DHCPv6 clients and servers are identified by a DHCP Unique Identifier (DUID) included in the client identifier and server identifier options. Static or dynamic address prefixes may be assigned by a DHCPv6 server based on the client's DUID.

EXAMPLE

```
Console#show ipv6 dhcp duid
DHCPv6 Unique Identifier (DUID): 0001-0001-50AB9A72-B40EDC34E63C
Console#
```

show ipv6 dhcp vlan This command shows DHCPv6 information for the specified interface(s).

SYNTAX

show ipv6 dhcp vlan *vlan-id*

vlan-id - VLAN ID, specified as a single number, a range of consecutive numbers separated by a hyphen, or multiple numbers separated by commas. (Range: 1-4094; Maximum command length: 300 characters)

COMMAND MODE

Privileged Exec

EXAMPLE

```

Console#show ipv6 dhcp vlan 1
VLAN 1 is in DHCP client mode, Rapid-Commit
List of known servers:
  Server address : FE80::250:FCFF:FEF9:A494
  DUID           : 0001-0001-48CFB0D5-F48F2A006801

  Server address : FE80::250:FCFF:FEF9:A405
  DUID           : 0001-0001-38CF5AB0-F48F2A003917
Console#
    
```

DHCP RELAY

This section describes commands used to the switch to relay DHCP requests from local hosts to a remote DHCP server.

Table 208: DHCP Relay Commands

Command	Function	Mode
<code>ip dhcp relay server</code>	Specifies DHCP server addresses for relay	IC
<code>ip dhcp restart relay</code>	Enables DHCP relay agent	PE

ip dhcp relay server This command specifies the DHCP server or relay server addresses to use. Use the **no** form to clear all addresses.

SYNTAX

ip dhcp relay server *address1* [*address2* [*address3* ...]]

no ip dhcp relay server

address - IP address of DHCP server. (Range: 1-5 addresses)

DEFAULT SETTING

None

COMMAND MODE

Interface Configuration (VLAN)

USAGE GUIDELINES

- ◆ DHCP relay service applies to DHCP client requests received on the specified VLAN.
- ◆ This command is used to configure DHCP relay for host devices attached to the switch. If DHCP relay service is enabled, and this switch sees a DHCP client request, it inserts its own IP address into the request so that the DHCP server will know the subnet where the client is located. Then, the switch forwards the packet to a DHCP server on another network. When the server receives the DHCP request, it allocates a free IP address for the DHCP client from its defined scope for the DHCP client's subnet, and sends a DHCP response back to the DHCP relay agent (i.e., this switch). This switch then passes the DHCP response received from the server to the client.
- ◆ You must specify the IP address for at least one DHCP server. Otherwise, the switch's DHCP relay agent will not forward client requests to a DHCP server. Up to five DHCP servers can be specified in order of preference.

If any of the specified DHCP server addresses are not located in the same network segment with this switch, use the [ip default-gateway](#) or [ipv6 default-gateway](#) command to specify the default router through which this switch can reach other IP subnetworks.

- ◆ To start DHCP relay service, enter the [ip dhcp restart relay](#) command.

EXAMPLE

```
Console(config)#interface vlan 1
Console(config-if)#ip dhcp relay server 10.1.0.99
Console(config-if)#
```

RELATED COMMANDS

[ip dhcp restart relay \(1418\)](#)

ip dhcp restart relay This command enables DHCP relay for the specified VLAN. Use the **no** form to disable it.

DEFAULT SETTING

Disabled

COMMAND MODE

Privileged Exec

COMMAND USAGE

This command is used to configure DHCP relay functions for host devices attached to the switch. If DHCP relay service is enabled, and this switch sees a DHCP request broadcast, it inserts its own IP address into the

request so the DHCP server will know the subnet where the client is located. Then, the switch forwards the packet to the DHCP server on another network. When the server receives the DHCP request, it allocates a free IP address for the DHCP client from its defined scope for the DHCP client's subnet, and sends a DHCP response back to the DHCP relay agent (i.e., this switch). This switch then broadcasts the DHCP response received from the server to the client.

EXAMPLE

In the following example, the device is reassigned the same address.

```
Console#ip dhcp restart relay
Console#show ip interface
Vlan 1 is up, addressing mode is Dhcp
  Interface address is 10.1.0.254, mask is 255.255.255.0, Primary
  MTU is 1500 bytes
  Proxy ARP is disabled
  Split horizon is enabled
Console#
```

RELATED COMMANDS

[ip dhcp relay server \(1417\)](#)

An IP Version 4 and Version 6 address may be used for management access to the switch over the network. Both IPv4 or IPv6 addresses can be used simultaneously to access the switch. You can manually configure a specific IPv4 or IPv6 address or direct the switch to obtain an IPv4 address from a BOOTP or DHCP server when it is powered on. An IPv6 address can either be manually configured or dynamically generated.

An IPv4 address for this switch is obtained via DHCP by default for VLAN 1. You may also need to establish an IPv4 or IPv6 default gateway between this device and management stations that exist on another network segment.

Table 209: IP Interface Commands

Command Group	Function
IPv4 Interface	Configures an IPv4 address for the switch
IPv6 Interface	Configures an IPv6 address for the switch
ND Snooping	Maintains IPv6 prefix table and user address binding table which can be used for stateless address auto-configuration or for address filtering by IPv6 Source Guard

IPv4 INTERFACE

There are no IP addresses assigned to this switch by default. You must manually configure a new address to manage the switch over your network or to connect the switch to existing IP subnets. You may also need to establish a default gateway between this device and management stations or other devices that exist on another network segment.

This section includes commands for configuring IP interfaces, the Address Resolution Protocol (ARP) and Proxy ARP.

Table 210: IPv4 Interface Commands

Command Group	Function
Basic IPv4 Configuration	Configures the IP address for interfaces and the gateway router
ARP Configuration	Configures static, dynamic and proxy ARP service

BASIC IPv4 CONFIGURATION This section describes commands used to configure IP addresses for VLAN interfaces on the switch.

Table 211: Basic IP Configuration Commands

Command	Function	Mode
<code>ip address</code>	Sets the IP address for the current interface	IC
<code>ip default-gateway</code>	Defines the default gateway through which this switch can reach other subnetworks	GC
<code>show ip interface</code>	Displays the IP settings for this device	PE
<code>show ip route</code>	Displays specified entries in the routing table	PE
<code>show ip traffic</code>	Displays statistics for IP, ICMP, UDP, TCP and ARP protocols	PE
<code>traceroute</code>	Shows the route packets take to the specified host	PE
<code>ping</code>	Sends ICMP echo request packets to another node on the network	NE, PE

ip address This command sets the IPv4 address for the currently selected VLAN interface. Use the **no** form to remove an IP address.

SYNTAX

```
ip address {ip-address netmask [secondary]
             [default-gateway ip-address] | bootp | dhcp}
no ip address [ip-address netmask [secondary] | dhcp]
```

ip-address - IP address

netmask - Network mask for the associated IP subnet. This mask identifies the host address bits used for routing to specific subnets. The network mask can be either in the traditional format xxx.xxx.xxx.xxx or use classless format with the range /5 to /32. For example the subnet 255.255.224.0 would be /19.

secondary - Specifies a secondary IP address.

default-gateway - The default gateway. (Refer to the `ip default-gateway` command which provides the same function.)

bootp - Obtains IP address from BOOTP.

dhcp - Obtains IP address from DHCP.

DEFAULT SETTING

DHCP

COMMAND MODE

Interface Configuration (VLAN)

COMMAND USAGE

- ◆ If this router is directly connected to end node devices (or connected to end nodes via shared media) that will be assigned to a specific subnet, then you must create a router interface for each VLAN that will support

routing. The router interface consists of an IP address and subnet mask. This interface address defines both the network number to which the router interface is attached and the router's host number on that network. In other words, a router interface address defines the network and subnetwork numbers of the segment that is connected to that interface, and allows you to send IP packets to or from the router.

- ◆ Before any network interfaces are configured on the router, first create a VLAN for each unique user group, or for each network application and its associated users. Then assign the ports associated with each of these VLANs.
- ◆ An IP address must be assigned to this device to gain management access over the network or to connect the router to existing IP subnets. A specific IP address can be manually configured, or the router can be directed to obtain an address from a BOOTP or DHCP server. Valid IP addresses consist of four numbers, 0 to 255, separated by periods. Anything other than this format is not be accepted by the configuration program.
- ◆ An interface can have only one primary IP address, but can have many secondary IP addresses. In other words, secondary addresses need to be specified if more than one IP subnet can be accessed through this interface. Note that a secondary address cannot be configured prior to setting the primary IP address, and the primary address cannot be removed if a secondary address is still present. Also, if any router/switch in a network segment uses a secondary address, all other routers/switches in that segment must also use a secondary address from the same network or subnet address space.
- ◆ If **bootp** or **dhcp** options are selected, the system will immediately start broadcasting service requests for all VLANs configured to obtain address assignments through BOOTP or DHCP. IP is enabled but will not function until a BOOTP or DHCP reply has been received. Requests are broadcast periodically by the router in an effort to learn its IP address. (BOOTP and DHCP values can include the IP address, default gateway, and subnet mask). If the DHCP/BOOTP server is slow to respond, you may need to use the `ip dhcp restart client` command to re-start broadcasting service requests, or reboot the switch.



NOTE: Each VLAN group can be assigned its own IP interface address. You can manage the switch via any of these IP addresses.

EXAMPLE

In the following example, the device is assigned an address in VLAN 1.

```
Console(config)#interface vlan 1
Console(config-if)#ip address 192.168.1.5 255.255.255.0
Console(config-if)#
```

This example assigns an IP address to VLAN 2 using a classless network mask.

```
Console(config)#interface vlan 2
Console(config-if)#ip address 10.2.2.1/24
Console(config-if)#
```

RELATED COMMANDS

[ip dhcp restart client \(1413\)](#)
[ip default-gateway \(1424\)](#)
[ipv6 address \(1434\)](#)

ip default-gateway This command specifies the default gateway for destinations not found in local routing tables. Use the **no** form to remove a default gateway.

SYNTAX

ip default-gateway *gateway*

no ip default-gateway

gateway - IP address of the default gateway

DEFAULT SETTING

No default gateway is established.

COMMAND MODE

Global Configuration

COMMAND USAGE

- ◆ The default gateway can also be defined using the following Global configuration command: **ip route 0.0.0.0 0.0.0.0** *gateway-address*.
- ◆ Static routes can also be defined using the [ip route](#) command to ensure that traffic to the designated address or subnet passes through a preferred gateway.
- ◆ A default gateway can only be successfully set when a network interface that directly connects to the gateway has been configured on the router.
- ◆ The same link-local address may be used by different interfaces/nodes in different zones (RFC 4007). Therefore, when specifying a link-local address for a default gateway, include zone-id information indicating the VLAN identifier after the % delimiter. For example, FE80::7272%1 identifies VLAN 1 as the interface.

EXAMPLE

The following example defines a default gateway for this device:

```
Console(config)#ip default-gateway 10.1.1.254
Console(config)#
```

RELATED COMMANDS

[ip address \(1422\)](#)
[ip route \(1468\)](#)
[ipv6 default-gateway \(1433\)](#)

show ip interface This command displays the settings of an IPv4 interface.

COMMAND MODE

Privileged Exec

EXAMPLE

```
Console#show ip interface
VLAN 1 is Administrative Up - Link Up
  Address is 70-72-CF-94-22-34
  Index: 1001, MTU: 1500
  Address Mode is DHCP
  IP Address: 192.168.0.5 Mask: 255.255.255.0
  Proxy ARP is disabled
  DHCP relay server: 0.0.0.0
Console#
```

RELATED COMMANDS

[ip address \(1422\)](#)
[show ipv6 interface \(1442\)](#)

show ip traffic This command displays statistics for IP, ICMP, UDP, TCP and ARP protocols.

COMMAND MODE

Privileged Exec

EXAMPLE

```
Console#show ip traffic
IP Statistics:
IP received
    7845 total received
        header errors
        unknown protocols
        address errors
        discards
    7845 delivers
        reassembly request datagrams
        reassembly succeeded
        reassembly failed
```

```
IP sent
    forwards datagrams
    9903 requests
    discards
    no routes
    generated fragments
    fragment succeeded
    fragment failed

ICMP Statistics:
ICMP received
    input
    errors
    destination unreachable messages
    time exceeded messages
    parameter problem message
    echo request messages
    echo reply messages
    redirect messages
    timestamp request messages
    timestamp reply messages
    source quench messages
    address mask request messages
    address mask reply messages

ICMP sent
    output
    errors
    destination unreachable messages
    time exceeded messages
    parameter problem message
    echo request messages
    echo reply messages
    redirect messages
    timestamp request messages
    timestamp reply messages
    source quench messages
    address mask request messages
    address mask reply messages

UDP Statistics:
    input
    no port errors
    other errors
    output

TCP Statistics:
    7841 input
    input errors
    9897 output

Console#
```

traceroute This command shows the route packets take to the specified destination.

SYNTAX

traceroute *host*

host - IP address or alias of the host.

DEFAULT SETTING

None

COMMAND MODE

Privileged Exec

COMMAND USAGE

- ◆ Use the **traceroute** command to determine the path taken to reach a specified destination.
- ◆ A trace terminates when the destination responds, when the maximum timeout (TTL) is exceeded, or the maximum number of hops is exceeded.
- ◆ The traceroute command first sends probe datagrams with the TTL value set at one. This causes the first router to discard the datagram and return an error message. The trace function then sends several probe messages at each subsequent TTL level and displays the round-trip time for each message. Not all devices respond correctly to probes by returning an "ICMP port unreachable" message. If the timer goes off before a response is returned, the trace function prints a series of asterisks and the "Request Timed Out" message. A long sequence of these messages, terminating only when the maximum timeout has been reached, may indicate this problem with the target device.
- ◆ If the target device does not respond or other errors are detected, the switch will indicate this by one of the following messages:
 - * - No Response
 - H - Host Unreachable
 - N - Network Unreachable
 - P - Protocol Unreachable
 - O -Other

EXAMPLE

```

Console#traceroute 192.168.0.1
Press "ESC" to abort.
Traceroute to 192.168.0.1, 30 hops max, timeout is 3 seconds
Hop  Packet 1  Packet 2  Packet 3  IP Address
-----
  1      20 ms   <10 ms   <10 ms   192.168.0.1

Trace completed.
Console#

```

ping This command sends (IPv4) ICMP echo request packets to another node on the network.

SYNTAX

ping *host* [**count** *count*] [**size** *size*]

host - IP address or alias of the host.

count - Number of packets to send. (Range: 1-16)

size - Number of bytes in a packet. (Range: 32-512)
The actual packet size will be eight bytes larger than the size specified because the switch adds header information.

DEFAULT SETTING

count: 5
size: 32 bytes

COMMAND MODE

Normal Exec, Privileged Exec

COMMAND USAGE

- ◆ Use the ping command to see if another site on the network can be reached.
- ◆ The following are some results of the **ping** command:
 - *Normal response* - The normal response occurs in one to ten seconds, depending on network traffic.
 - *Destination does not respond* - If the host does not respond, a "timeout" appears in ten seconds.
 - *Destination unreachable* - The gateway for this destination indicates that the destination is unreachable.
 - *Network or host unreachable* - The gateway found no corresponding entry in the route table.
- ◆ When pinging a host name, be sure the DNS server has been defined ([page 1405](#)) and host name-to-address translation enabled ([page 1402](#)). If necessary, local devices can also be specified in the DNS static host table ([page 1404](#)).

EXAMPLE

```
Console#ping 10.1.0.9
Type ESC to abort.
PING to 10.1.0.9, by 5 32-byte payload ICMP packets, timeout is 5 seconds
response time: 10 ms
response time: 10 ms
response time: 10 ms
response time: 10 ms
response time: 0 ms
Ping statistics for 10.1.0.9:
 5 packets transmitted, 5 packets received (100%), 0 packets lost (0%)
Approximate round trip times:
  Minimum = 0 ms, Maximum = 10 ms, Average = 8 ms
Console#
```

RELATED COMMANDS

[interface \(996\)](#)

ARP CONFIGURATION This section describes commands used to configure the Address Resolution Protocol (ARP) on the switch.

Table 212: Address Resolution Protocol Commands

Command	Function	Mode
<code>arp</code>	Adds a static entry in the ARP cache	GC
<code>ip proxy-arp</code>	Enables proxy ARP service	IC
<code>clear arp-cache</code>	Deletes all dynamic entries from the ARP cache	PE
<code>show arp</code>	Displays entries in the ARP cache	NE, PE

arp This command adds a static entry in the Address Resolution Protocol (ARP) cache. Use the **no** form to remove an entry from the cache.

SYNTAX

arp *ip-address hardware-address*

no arp *ip-address*

ip-address - IP address to map to a specified hardware address.

hardware-address - Hardware address to map to a specified IP address. (The format for this address is xx-xx-xx-xx-xx-xx.)

DEFAULT SETTING

No default entries

COMMAND MODE

Global Configuration

COMMAND USAGE

- ◆ The ARP cache is used to map 32-bit IP addresses into 48-bit hardware (i.e., Media Access Control) addresses. This cache includes entries for hosts and other routers on local network interfaces defined on this router.
- ◆ The maximum number of static entries allowed in the ARP cache is 128.
- ◆ You may need to enter a static entry in the cache if there is no response to an ARP broadcast message. For example, some applications may not respond to ARP requests or the response arrives too late, causing network operations to time out.
- ◆ Static entries will not be aged out nor deleted when power is reset. A static entry can only be removed through the configuration interface.

EXAMPLE

```
Console(config)#arp 10.1.0.19 01-02-03-04-05-06
Console(config)#
```

RELATED COMMANDS

[clear arp-cache \(1430\)](#)
[show arp \(1431\)](#)

ip proxy-arp This command enables proxy Address Resolution Protocol (ARP). Use the **no** form to disable proxy ARP.

SYNTAX

[no] ip proxy-arp

DEFAULT SETTING

Disabled

COMMAND MODE

Interface Configuration (VLAN)

COMMAND USAGE

- ◆ Proxy ARP allows a non-routing device to determine the MAC address of a host on another subnet or network.
- ◆ End stations that require Proxy ARP must view the entire network as a single network. These nodes must therefore use a smaller subnet mask than that used by the router or other relevant network devices.
- ◆ Extensive use of Proxy ARP can degrade router performance because it may lead to increased ARP traffic and increased search time for larger ARP address tables.

EXAMPLE

```
Console(config)#interface vlan 3
Console(config-if)#ip proxy-arp
Console(config-if)#
```

clear arp-cache This command deletes all dynamic entries from the Address Resolution Protocol (ARP) cache.

COMMAND MODE

Privileged Exec

EXAMPLE

This example clears all dynamic entries in the ARP cache.

```
Console#clear arp-cache
This operation will delete all the dynamic entries in ARP Cache.
Are you sure to continue this operation (y/n)?y
Console#
```

show arp This command displays entries in the Address Resolution Protocol (ARP) cache.

COMMAND MODE

Normal Exec, Privileged Exec

COMMAND USAGE

This command displays information about the ARP cache. The first line shows the cache timeout. It also shows each cache entry, including the IP address, MAC address, type (static, dynamic, other), and VLAN interface. Note that entry type "other" indicates local addresses for this router.

EXAMPLE

This example displays all entries in the ARP cache.

```
Console#show arp
ARP Cache Timeout: 1200 (seconds)

IP Address      MAC Address      Type      Interface
-----
10.1.0.0        FF-FF-FF-FF-FF-FF other      VLAN1
10.1.0.254     00-00-AB-CD-00-00 other      VLAN1
10.1.0.255     FF-FF-FF-FF-FF-FF other      VLAN1
145.30.20.23   09-50-40-30-20-10 dynamic    VLAN3

Total entry : 5
Console#
```

IPv6 INTERFACE

This switch supports the following IPv6 interface commands.

Table 213: IPv6 Configuration Commands

Command	Function	Mode
<i>Interface Address Configuration and Utilities</i>		
<code>ipv6 default-gateway</code>	Sets an IPv6 default gateway for traffic with no known next hop	GC
<code>ipv6 address</code>	Configures an IPv6 global unicast address, and enables IPv6 on an interface	IC
<code>ipv6 address autoconfig</code>	Enables automatic configuration of IPv6 global unicast addresses on an interface and enables IPv6 on the interface	IC
<code>ipv6 address eui-64</code>	Configures an IPv6 global unicast address for an interface using an EUI-64 interface ID in the low order 64 bits, and enables IPv6 on the interface	IC
<code>ipv6 address link-local</code>	Configures an IPv6 link-local address for an interface and enables IPv6 on the interface	IC
<code>ipv6 enable</code>	Enables IPv6 on an interface that has not been configured with an explicit IPv6 address	IC
<code>ipv6 mtu</code>	Sets the size of the maximum transmission unit (MTU) for IPv6 packets sent on an interface	IC
<code>show ipv6 default-gateway</code>	Displays the current IPv6 default gateway	NE, PE
<code>show ipv6 interface</code>	Displays the usability and configured settings for IPv6 interfaces	NE, PE
<code>show ipv6 mtu</code>	Displays maximum transmission unit (MTU) information for IPv6 interfaces	NE, PE
<code>show ipv6 traffic</code>	Displays statistics about IPv6 traffic	NE, PE
<code>clear ipv6 traffic</code>	Resets IPv6 traffic counters	PE
<code>ping6</code>	Sends IPv6 ICMP echo request packets to another node on the network	PE
<code>traceroute6</code>	Shows the route packets take to the specified host	PE
<i>Neighbor Discovery</i>		
<code>ipv6 nd dad attempts</code>	Configures the number of consecutive neighbor solicitation messages sent on an interface during duplicate address detection	IC
<code>ipv6 nd ns-interval</code>	Configures the interval between IPv6 neighbor solicitation retransmissions on an interface	IC
<code>ipv6 nd raguard</code>	Blocks incoming Router Advertisement and Router Redirect packets	IC
<code>ipv6 nd reachable-time</code>	Configures the amount of time that a remote IPv6 node is considered reachable after some reachability confirmation event has occurred	IC
<code>clear ipv6 neighbors</code>	Deletes all dynamic entries in the IPv6 neighbor discovery cache	PE
<code>show ipv6 nd raguard</code>	Displays the configuration setting for RA Guard	PE
<code>show ipv6 neighbors</code>	Displays information in the IPv6 neighbor discovery cache	PE

Interface Address Configuration and Utilities

ipv6 default-gateway This command sets an IPv6 default gateway to use for destinations with no known next hop. Use the **no** form to remove a previously configured default gateway.

SYNTAX

ipv6 default-gateway *ipv6-address*

no ipv6 address

ipv6-address - The IPv6 address of the default next hop router to use for destinations with no known next hop.

DEFAULT SETTING

No default gateway is defined

COMMAND MODE

Global Configuration

COMMAND USAGE

- ◆ All IPv6 addresses must be according to RFC 2373 "IPv6 Addressing Architecture," using 8 colon-separated 16-bit hexadecimal values. One double colon may be used in the address to indicate the appropriate number of zeros required to fill the undefined fields.
- ◆ The same link-local address may be used by different interfaces/nodes in different zones (RFC 4007). Therefore, when specifying a link-local address, include zone-id information indicating the VLAN identifier after the % delimiter. For example, FE80::7272%1 identifies VLAN 1 as the interface.
- ◆ An IPv6 default gateway must be defined if the destination has been assigned an IPv6 address and is located in a different IP segment.
- ◆ An IPv6 default gateway can only be successfully set when a network interface that directly connects to the gateway has been configured on the switch.

EXAMPLE

The following example defines a default gateway for this device:

```
Console(config)#ipv6 default-gateway FE80::269:3EF9:FE19:6780
Console(config)#
```

RELATED COMMANDS

[show ipv6 default-gateway \(1442\)](#)
[ip default-gateway \(1424\)](#)

ipv6 address This command configures an IPv6 global unicast address and enables IPv6 on an interface. Use the **no** form without any arguments to remove all IPv6 addresses from the interface, or use the **no** form with a specific IPv6 address to remove that address from the interface.

SYNTAX

[no] ipv6 address *ipv6-address*[/*prefix-length*]

ipv6-address - A full IPv6 address including the network prefix and host address bits.

prefix-length - A decimal value indicating how many contiguous bits (from the left) of the address comprise the prefix (i.e., the network portion of the address).

DEFAULT SETTING

No IPv6 addresses are defined

COMMAND MODE

Interface Configuration (VLAN)

COMMAND USAGE

- ◆ All IPv6 addresses must be according to RFC 2373 "IPv6 Addressing Architecture," using 8 colon-separated 16-bit hexadecimal values. One double colon may be used in the address to indicate the appropriate number of zeros required to fill the undefined fields.
- ◆ To connect to a larger network with multiple subnets, you must configure a global unicast address. This address can be manually configured with this command, or it can be automatically configured using the [ipv6 address autoconfig](#) command.
- ◆ If a link-local address has not yet been assigned to this interface, this command will assign the specified static global unicast address and also dynamically generate a link-local unicast address for the interface. (The link-local address is made with an address prefix of FE80 and a host portion based the switch's MAC address in modified EUI-64 format.)
- ◆ If a duplicate address is detected, a warning message is sent to the console.

EXAMPLE

This example specifies a full IPv6 address and prefix length.

```
Console(config)#interface vlan 1
Console(config-if)#ipv6 address 2001:DB8:2222:7272::72/96
Console(config-if)#end
Console#show ipv6 interface
VLAN 1 is up
IPv6 is enabled
Link-Local Address:
  fe80::b60e:dcff:fe34:9608%1/64
Global Unicast Address(es):
  2001:db8:2222:7272::72/96, subnet is 2001:db8:2222:7272::/96
```

```

Joined Group Address(es) :
ff02::1:ff00:72
ff02::1:ff34:9608
ff02::1
IPv6 link MTU is 1500 bytes
ND DAD is enabled, number of DAD attempts: 3
ND retransmit interval is 1000 milliseconds
ND advertised retransmit interval is 0 milliseconds
ND reachable time is 30000 milliseconds
ND advertised reachable time is 0 milliseconds
ND advertised router lifetime is 1800 seconds

Console#

```

RELATED COMMANDS

[ipv6 address eui-64 \(1436\)](#)
[ipv6 address autoconfig \(1435\)](#)
[show ipv6 interface \(1442\)](#)
[ip address \(1422\)](#)

ipv6 address autoconfig This command enables stateless autoconfiguration of IPv6 addresses on an interface and enables IPv6 on the interface. The network portion of the address is based on prefixes received in IPv6 router advertisement messages; the host portion is based on the modified EUI-64 form of the interface identifier (i.e., the switch's MAC address). Use the **no** form to remove the address generated by this command.

SYNTAX

[no] ipv6 address autoconfig

DEFAULT SETTING

No IPv6 addresses are defined

COMMAND MODE

Interface Configuration (VLAN)

COMMAND USAGE

- ◆ If a link local address has not yet been assigned to this interface, this command will dynamically generate a global unicast address (if a global prefix is included in received router advertisements) and a link local address for the interface. (The link-local address is made with an address prefix of FE80 and a host portion based the switch's MAC address in modified EUI-64 format.)
- ◆ If a duplicate address is detected, a warning message is sent to the console.
- ◆ When DHCPv6 is restarted, the switch may attempt to acquire an IP address prefix through stateful address autoconfiguration. If the router advertisements have the "other stateful configuration" flag set, the switch may also attempt to acquire other non-address configuration

information (such as a default gateway) from a DHCPv6 server when DHCPv6 is restarted.

EXAMPLE

This example assigns a dynamic global unicast address to the switch.

```
Console(config)#interface vlan 1
Console(config-if)#ipv6 address autoconfig
Console(config-if)#ipv6 enable
Console(config-if)#end
Console#show ipv6 interface
VLAN 1 is up
IPv6 is enabled
Link-local address:
    fe80::260:3eff:fe11:6700%1/64
Global unicast address(es):
    2001:db8:2222:7272::/64, subnet is 2001:db8:2222:7272::/64[AUTOCONFIG]
    valid lifetime 2591978 preferred lifetime 604778
Joined group address(es):
    ff02::1:ff00:73
    ff02::1:ff39:f44b
    ff02::1
IPv6 link MTU is 1500 bytes
ND DAD is enabled, number of DAD attempts: 3.
ND retransmit interval is 1000 milliseconds
ND advertised retransmit interval is 0 milliseconds
ND reachable time is 30000 milliseconds
ND advertised reachable time is 0 milliseconds
ND advertised router lifetime is 1800 seconds

Console#
```

RELATED COMMANDS

[ipv6 address \(1434\)](#)

[show ipv6 interface \(1442\)](#)

ipv6 address eui-64 This command configures an IPv6 address for an interface using an EUI-64 interface ID in the low order 64 bits and enables IPv6 on the interface. Use the **no** form without any arguments to remove all manually configured IPv6 addresses from the interface. Use the **no** form with a specific address to remove it from the interface.

SYNTAX

ipv6 address *ipv6-prefix/prefix-length* **eui-64**

no ipv6 address [*ipv6-prefix/prefix-length* **eui-64**]

ipv6-prefix - The IPv6 network portion of the address assigned to the interface.

prefix-length - A decimal value indicating how many contiguous bits (from the left) of the address comprise the prefix (i.e., the network portion of the address).

DEFAULT SETTING

No IPv6 addresses are defined

COMMAND MODE

Interface Configuration (VLAN)

COMMAND USAGE

- ◆ The prefix must be formatted according to RFC 2373 “IPv6 Addressing Architecture,” using 8 colon-separated 16-bit hexadecimal values. One double colon may be used in the address to indicate the appropriate number of zeros required to fill the undefined fields.
- ◆ If a link local address has not yet been assigned to this interface, this command will dynamically generate a global unicast address and a link-local address for this interface. (The link-local address is made with an address prefix of FE80 and a host portion based the switch’s MAC address in modified EUI-64 format.)
- ◆ Note that the value specified in the ipv6-prefix may include some of the high-order host bits if the specified prefix length is less than 64 bits. If the specified prefix length exceeds 64 bits, then the network portion of the address will take precedence over the interface identifier.
- ◆ If a duplicate address is detected, a warning message is sent to the console.
- ◆ IPv6 addresses are 16 bytes long, of which the bottom 8 bytes typically form a unique host identifier based on the device’s MAC address. The EUI-64 specification is designed for devices that use an extended 8-byte MAC address. For devices that still use a 6-byte MAC address (also known as EUI-48 format), it must be converted into EUI-64 format by inverting the universal/local bit in the address and inserting the hexadecimal number FFFE between the upper and lower three bytes of the MAC address.
- ◆ For example, if a device had an EUI-48 address of 28-9F-18-1C-82-35, the global/local bit must first be inverted to meet EUI-64 requirements (i.e., 1 for globally defined addresses and 0 for locally defined addresses), changing 28 to 2A. Then the two bytes FFFE are inserted between the OUI (i.e., company id) and the rest of the address, resulting in a modified EUI-64 interface identifier of 2A-9F-18-FF-FE-1C-82-35.
- ◆ This host addressing method allows the same interface identifier to be used on multiple IP interfaces of a single device, as long as those interfaces are attached to different subnets.

EXAMPLE

This example uses the network prefix of 2001:0DB8:0:1::/64, and specifies that the EUI-64 interface identifier be used in the lower 64 bits of the address.

```
Console(config)#interface vlan 1
Console(config-if)#ipv6 address 2001:0DB8:0:1::/64 eui-64
Console(config-if)#end
Console#show ipv6 interface
VLAN 1 is up
IPv6 is enabled
Link-Local Address:
    fe80::b60e:dcff:fe34:9608%1/64
Global Unicast Address(es):
    2001:db8:0:1:b60e:dcff:fe34:9608/64, subnet is 2001:db8:0:1::/64[EUI]
Joined Group Address(es):
    ff02::1:ff34:9608
    ff02::1
IPv6 link MTU is 1500 bytes
ND DAD is enabled, number of DAD attempts: 3
ND retransmit interval is 1000 milliseconds
ND advertised retransmit interval is 0 milliseconds
ND reachable time is 30000 milliseconds
ND advertised reachable time is 0 milliseconds
ND advertised router lifetime is 1800 seconds

Console#
```

RELATED COMMANDS

[ipv6 address autoconfig \(1435\)](#)

[show ipv6 interface \(1442\)](#)

ipv6 address link-local

This command configures an IPv6 link-local address for an interface and enables IPv6 on the interface. Use the **no** form without any arguments to remove all manually configured IPv6 addresses from the interface. Use the **no** form with a specific address to remove it from the interface.

SYNTAX

ipv6 address *ipv6-address* **link-local**

no ipv6 address [*ipv6-address* **link-local**]

ipv6-address - The IPv6 address assigned to the interface.

DEFAULT SETTING

No IPv6 addresses are defined

COMMAND MODE

Interface Configuration (VLAN)

COMMAND USAGE

- ◆ The specified address must be formatted according to RFC 2373 "IPv6 Addressing Architecture," using 8 colon-separated 16-bit hexadecimal values. One double colon may be used in the address to indicate the

appropriate number of zeros required to fill the undefined fields. And the address prefix must be in the range of FE80~FEBF.

- ◆ The address specified with this command replaces a link-local address that was automatically generated for the interface.
- ◆ You can configure multiple IPv6 global unicast addresses per interface, but only one link-local address per interface.
- ◆ If a duplicate address is detected, a warning message is sent to the console.

EXAMPLE

This example assigns a link-local address of FE80::269:3EF9:FE19:6779 to VLAN 1. Note that a prefix in the range of FE80~FEBF is required for link-local addresses, and the first 16-bit group in the host address is padded with a zero in the form 0269.

```

Console(config)#interface vlan 1
Console(config-if)#ipv6 address FE80::269:3EF9:FE19:6779 link-local
Console(config-if)#end
Console#show ipv6 interface
VLAN 1 is up
IPv6 is enabled.
Link-local address:
  fe80::269:3ef9:fe19:6779%1/64
Global unicast address(es):
  2001:db8:0:1:b60e:dcff:fe34:9608/64, subnet is 2001:db8:0:1::/64[EUI]
Joined group address(es):
  ff02::1:ff19:6779
  ff02::1:ff34:9608
  ff02::1
IPv6 link MTU is 1500 bytes
ND DAD is enabled, number of DAD attempts: 3.
ND retransmit interval is 1000 milliseconds
ND advertised retransmit interval is 0 milliseconds
ND reachable time is 30000 milliseconds
ND advertised reachable time is 0 milliseconds
ND advertised router lifetime is 1800 seconds

Console#

```

RELATED COMMANDS

[ipv6 enable \(1439\)](#)
[show ipv6 interface \(1442\)](#)

ipv6 enable This command enables IPv6 on an interface that has not been configured with an explicit IPv6 address. Use the **no** form to disable IPv6 on an interface that has not been configured with an explicit IPv6 address.

SYNTAX

[no] ipv6 enable

DEFAULT SETTING

IPv6 is disabled

COMMAND MODE

Interface Configuration (VLAN)

COMMAND USAGE

- ◆ This command enables IPv6 on the current VLAN interface and automatically generates a link-local unicast address. The address prefix uses FE80, and the host portion of the address is generated by converting the switch's MAC address to modified EUI-64 format (see [page 1436](#)). This address type makes the switch accessible over IPv6 for all devices attached to the same local subnet.
- ◆ If a duplicate address is detected on the local segment, this interface will be disabled and a warning message displayed on the console.
- ◆ The **no ipv6 enable** command does not disable IPv6 for an interface that has been explicitly configured with an IPv6 address.

EXAMPLE

In this example, IPv6 is enabled on VLAN 1, and the link-local address FE80::2E0:CFF:FE00:FD/64 is automatically generated by the switch.

```
Console(config)#interface vlan 1
Console(config-if)#ipv6 enable
Console(config-if)#end
Console#show ipv6 interface
VLAN 1 is up
IPv6 is enabled.
Link-local address:
  fe80::2e0:cff:fe00:fd/64
Global unicast address(es):
  2001:db8:2222:7273::72/96, subnet is 2001:db8:2222:7273::/96
Joined group address(es):
  ff02::1:ff00:72
  ff02::1:ff00:fd
  ff02::1
IPv6 link MTU is 1280 bytes
ND DAD is enabled, number of DAD attempts: 3.
ND retransmit interval is 1000 milliseconds
ND advertised retransmit interval is 0 milliseconds
ND reachable time is 30000 milliseconds
ND advertised reachable time is 0 milliseconds
ND advertised router lifetime is 1800 seconds

Console#
```

RELATED COMMANDS

[ipv6 address link-local \(1438\)](#)
[show ipv6 interface \(1442\)](#)

ipv6 mtu This command sets the size of the maximum transmission unit (MTU) for IPv6 packets sent on an interface. Use the **no** form to restore the default setting.

SYNTAX

ipv6 mtu *size*

no ipv6 mtu

size - Specifies the MTU size. (Range: 1280-65535 bytes)

DEFAULT SETTING

1500 bytes

COMMAND MODE

Interface Configuration (VLAN)

COMMAND USAGE

- ◆ If a non-default value is configured, an MTU option is included in the router advertisements sent from this device.
- ◆ The maximum value set by this command cannot exceed the MTU of the physical interface, which is currently fixed at 1500 bytes.
- ◆ IPv6 routers do not fragment IPv6 packets forwarded from other routers. However, traffic originating from an end-station connected to an IPv6 router may be fragmented.
- ◆ All devices on the same physical medium must use the same MTU in order to operate correctly.
- ◆ IPv6 must be enabled on an interface before the MTU can be set.

EXAMPLE

The following example sets the MTU for VLAN 1 to 1280 bytes:

```
Console(config)#interface vlan 1
Console(config-if)#ipv6 mtu 1280
Console(config-if)#
```

RELATED COMMANDS

[show ipv6 mtu \(1444\)](#)

[jumbo frame \(735\)](#)

show ipv6 default-gateway This command displays the current IPv6 default gateway.

COMMAND MODE

Normal Exec, Privileged Exec

EXAMPLE

The following shows the default gateway configured for this device:

```
Console#show ipv6 default-gateway
IPv6 default gateway 2001:DB8:2222:7272::254

Console#
```

show ipv6 interface This command displays the usability and configured settings for IPv6 interfaces.

SYNTAX

show ipv6 interface [**brief** [**vlan** *vlan-id* [*ipv6-prefix/prefix-length*]]]

brief - Displays a brief summary of IPv6 operational status and the addresses configured for each interface.

vlan-id - VLAN ID (Range: 1-4094)

ipv6-prefix - The IPv6 network portion of the address assigned to the interface. The prefix must be formatted according to RFC 2373 "IPv6 Addressing Architecture," using 8 colon-separated 16-bit hexadecimal values. One double colon may be used in the address to indicate the appropriate number of zeros required to fill the undefined fields.

prefix-length - A decimal value indicating how many of the contiguous bits (from the left) of the address comprise the prefix (i.e., the network portion of the address).

COMMAND MODE

Normal Exec, Privileged Exec

EXAMPLE

This example displays all the IPv6 addresses configured for the switch.

```
Console#show ipv6 interface
VLAN 1 is up
IPv6 is enabled.
Link-local address:
  fe80::2e0:cff:fe00:fd/64
Global unicast address(es):
  2001:db8:2222:7273::72/96, subnet is 2001:db8:2222:7273::/96
Joined group address(es):
  ff02::1:ff00:72
  ff02::1:ff00:fd
  ff02::1
IPv6 link MTU is 1280 bytes
```

```
ND DAD is enabled, number of DAD attempts: 3.
ND retransmit interval is 1000 milliseconds
ND advertised retransmit interval is 0 milliseconds
ND reachable time is 30000 milliseconds
ND advertised reachable time is 0 milliseconds
ND advertised router lifetime is 1800 seconds
```

Console#

Table 214: show ipv6 interface - display description

Field	Description
VLAN	A VLAN is marked "up" if the switch can send and receive packets on this interface, "down" if a line signal is not present, or "administratively down" if the interface has been disabled by the administrator.
IPv6	IPv6 is marked "enable" if the switch can send and receive IP traffic on this interface, "disable" if the switch cannot send and receive IP traffic on this interface, or "stalled" if a duplicate link-local address is detected on the interface.
Link-local address	Shows the link-local address assigned to this interface
Global unicast address(es)	Shows the global unicast address(es) assigned to this interface
Joined group address(es)	In addition to the unicast addresses assigned to an interface, a node is required to join the all-nodes multicast addresses FF01::1 and FF02::1 for all IPv6 nodes within scope 1 (interface-local) and scope 2 (link-local), respectively. FF01::1/16 is the transient interface-local multicast address for all attached IPv6 nodes, and FF02::1/16 is the link-local multicast address for all attached IPv6 nodes. The interface-local multicast address is only used for loopback transmission of multicast traffic. Link-local multicast addresses cover the same types as used by link-local unicast addresses, including all nodes (FF02::1), all routers (FF02::2), and solicited nodes (FF02::1:FFXX:XXXX) as described below. A node is also required to compute and join the associated solicited-node multicast addresses for every unicast and anycast address it is assigned. IPv6 addresses that differ only in the high-order bits, e.g. due to multiple high-order prefixes associated with different aggregations, will map to the same solicited-node address, thereby reducing the number of multicast addresses a node must join. In this example, FF02::1:FF90:0/104 is the solicited-node multicast address which is formed by taking the low-order 24 bits of the address and appending those bits to the prefix.
ND DAD	Indicates whether (neighbor discovery) duplicate address detection is enabled.
number of DAD attempts	The number of consecutive neighbor solicitation messages sent on the interface during duplicate address detection.
ND retransmit interval	The interval between IPv6 neighbor solicitation retransmissions sent on an interface during duplicate address detection.
ND advertised retransmit interval	The retransmit interval is included in all router advertisements sent out of an interface so that nodes on the same link use the same time value.
ND reachable time	The amount of time a remote IPv6 node is considered reachable after a reachability confirmation event has occurred
ND advertised reachable time	The reachable time is included in all router advertisements sent out of an interface so that nodes on the same link use the same time value.
ND advertised router lifetime	The length of time during which the prefix is valid for on-link determination.

This example displays a brief summary of IPv6 addresses configured on the switch.

```
Console#show ipv6 interface brief
Interface      VLAN      IPv6      IPv6 Address
-----
VLAN 1         Up        Up        2001:DB8:2222:7273::72/96
VLAN 1         Up        Up        FE80::2E0:CFF:FE00:FD%1/64
Console#
```

RELATED COMMANDS

[show ip interface \(1425\)](#)

show ipv6 mtu This command displays the maximum transmission unit (MTU) cache for destinations that have returned an ICMP packet-too-big message along with an acceptable MTU to this switch.

COMMAND MODE

Normal Exec, Privileged Exec

EXAMPLE

The following example shows the MTU cache for this device:

```
Console#show ipv6 mtu
MTU      Since      Destination Address
1400     00:04:21  5000:1::3
1280     00:04:50  FE80::203:A0FF:FED6:141D
Console#
```

Table 215: show ipv6 mtu - display description*

Field	Description
MTU	Adjusted MTU contained in the ICMP packet-too-big message returned from this destination, and now used for all traffic sent along this path.
Since	Time since an ICMP packet-too-big message was received from this destination.
Destination Address	Address which sent an ICMP packet-too-big message.

* No information is displayed if an IPv6 address has not been assigned to the switch.

show ipv6 traffic This command displays statistics about IPv6 traffic passing through this switch.

COMMAND MODE

Normal Exec, Privileged Exec

EXAMPLE

The following example shows statistics for all IPv6 unicast and multicast traffic, as well as ICMP, UDP and TCP statistics:

```
Console#show ipv6 traffic
IPv6 Statistics:
IPv6 received
    0 total received
    0 header errors
    0 too big errors
    0 no routes
    0 address errors
    0 unknown protocols
    0 truncated packets
    0 discards
    0 delivers
    0 reassembly request datagrams
    0 reassembled succeeded
    0 reassembled failed

IPv6 sent
    0 forwarded datagrams
22 requests
    0 discards
    0 no routes
    0 generated fragments
    0 fragment succeeded
    0 fragment failed

ICMPv6 Statistics:
ICMPv6 received
    0 input
    0 errors
    0 destination unreachable messages
    0 packet too big messages
    0 time exceeded messages
    0 parameter problem message
    0 echo request messages
    0 echo reply messages
    0 redirect messages
    0 group membership query messages
    0 group membership response messages
    0 group membership reduction messages
    0 router solicit messages
    0 router advertisement messages
    0 neighbor solicit messages
    0 neighbor advertisement messages
    0 redirect messages

ICMPv6 sent
22 output
    0 destination unreachable messages
    0 packet too big messages
    0 time exceeded messages
    0 parameter problem message
    0 echo request messages
    0 echo reply messages
    6 router solicit messages
    10 neighbor solicit messages
```

```

0 neighbor advertisement messages
0 redirect messages
0 group membership response messages
0 group membership reduction messages

UDP Statistics:
0 input
0 no port errors
0 other errors
0 output

Console#

```

Table 216: show ipv6 traffic - display description

Field	Description
<i>IPv6 Statistics</i>	
<i>IPv6 received</i>	
total received	The total number of input datagrams received by the interface, including those received in error.
header errors	The number of input datagrams discarded due to errors in their IPv6 headers, including version number mismatch, other format errors, hop count exceeded, IPv6 options, etc.
too big errors	The number of input datagrams that could not be forwarded because their size exceeded the link MTU of outgoing interface.
no routes	The number of input datagrams discarded because no route could be found to transmit them to their destination.
address errors	The number of input datagrams discarded because the IPv6 address in their IPv6 header's destination field was not a valid address to be received at this entity. This count includes invalid addresses (e.g., ::0) and unsupported addresses (e.g., addresses with unallocated prefixes). For entities which are not IPv6 routers and therefore do not forward datagrams, this counter includes datagrams discarded because the destination address was not a local address.
unknown protocols	The number of locally-addressed datagrams received successfully but discarded because of an unknown or unsupported protocol. This counter is incremented at the interface to which these datagrams were addressed which might not be necessarily the input interface for some of the datagrams.
truncated packets	The number of input datagrams discarded because datagram frame didn't carry enough data.
discards	The number of input IPv6 datagrams for which no problems were encountered to prevent their continued processing, but which were discarded (e.g., for lack of buffer space). Note that this counter does not include any datagrams discarded while awaiting re-assembly.
delivers	The total number of datagrams successfully delivered to IPv6 user-protocols (including ICMP). This counter is incremented at the interface to which these datagrams were addressed which might not be necessarily the input interface for some of the datagrams.
reassemble request datagrams	The number of IPv6 fragments received which needed to be reassembled at this interface. Note that this counter is incremented at the interface to which these fragments were addressed which might not be necessarily the input interface for some of the fragments.
reassemble succeeded	The number of IPv6 datagrams successfully reassembled. Note that this counter is incremented at the interface to which these datagrams were addressed which might not be necessarily the input interface for some of the fragments.

Table 216: show ipv6 traffic - display description (Continued)

Field	Description
reassemble failed	The number of failures detected by the IPv6 re-assembly algorithm (for whatever reason: timed out, errors, etc.). Note that this is not necessarily a count of discarded IPv6 fragments since some algorithms (notably the algorithm in RFC 815) can lose track of the number of fragments by combining them as they are received. This counter is incremented at the interface to which these fragments were addressed which might not be necessarily the input interface for some of the fragments.
<i>IPv6 sent</i>	
forwards datagrams	The number of output datagrams which this entity received and forwarded to their final destinations. In entities which do not act as IPv6 routers, this counter will include only those packets which were Source-Routed via this entity, and the Source-Route processing was successful. Note that for a successfully forwarded datagram the counter of the outgoing interface is incremented.
requests	The total number of IPv6 datagrams which local IPv6 user-protocols (including ICMP) supplied to IPv6 in requests for transmission. Note that this counter does not include any datagrams counted in ipv6IfStatsOutForwDatagrams.
discards	The number of output IPv6 datagrams for which no problem was encountered to prevent their transmission to their destination, but which were discarded (e.g., for lack of buffer space). Note that this counter would include datagrams counted in ipv6IfStatsOutForwDatagrams if any such packets met this (discretionary) discard criterion.
no routes	The number of input datagrams discarded because no route could be found to transmit them to their destination.
generated fragments	The number of output datagram fragments that have been generated as a result of fragmentation at this output interface.
fragment succeeded	The number of IPv6 datagrams that have been successfully fragmented at this output interface.
fragment failed	The number of IPv6 datagrams that have been discarded because they needed to be fragmented at this output interface but could not be.
<i>ICMPv6 Statistics</i>	
<i>ICMPv6 received</i>	
input	The total number of ICMP messages received by the interface which includes all those counted by ipv6IfIcmpInErrors. Note that this interface is the interface to which the ICMP messages were addressed which may not be necessarily the input interface for the messages.
errors	The number of ICMP messages which the interface received but determined as having ICMP-specific errors (bad ICMP checksums, bad length, etc.).
destination unreachable messages	The number of ICMP Destination Unreachable messages received by the interface.
packet too big messages	The number of ICMP Packet Too Big messages received by the interface.
time exceeded messages	The number of ICMP Time Exceeded messages received by the interface.
parameter problem message	The number of ICMP Parameter Problem messages received by the interface.
echo request messages	The number of ICMP Echo (request) messages received by the interface.
echo reply messages	The number of ICMP Echo Reply messages received by the interface.

Table 216: show ipv6 traffic - display description (Continued)

Field	Description
router solicit messages	The number of ICMP Router Solicit messages received by the interface.
router advertisement messages	The number of ICMP Router Advertisement messages received by the interface.
neighbor solicit messages	The number of ICMP Neighbor Solicit messages received by the interface.
neighbor advertisement messages	The number of ICMP Neighbor Advertisement messages received by the interface.
redirect messages	The number of Redirect messages received by the interface.
group membership query messages	The number of ICMPv6 Group Membership Query messages received by the interface.
group membership response messages	The number of ICMPv6 Group Membership Response messages received by the interface.
group membership reduction messages	The number of ICMPv6 Group Membership Reduction messages received by the interface.
multicast listener discovery version 2 reports	The number of MLDv2 reports received by the interface.
<i>ICMPv6 sent</i>	
output	The total number of ICMP messages which this interface attempted to send. Note that this counter includes all those counted by icmpOutErrors.
destination unreachable messages	The number of ICMP Destination Unreachable messages sent by the interface.
packet too big messages	The number of ICMP Packet Too Big messages sent by the interface.
time exceeded messages	The number of ICMP Time Exceeded messages sent by the interface.
parameter problem message	The number of ICMP Parameter Problem messages sent by the interface.
echo request messages	The number of ICMP Echo (request) messages sent by the interface.
echo reply messages	The number of ICMP Echo Reply messages sent by the interface.
router solicit messages	The number of ICMP Router Solicitation messages sent by the interface.
router advertisement messages	The number of ICMP Router Advertisement messages sent by the interface.
neighbor solicit messages	The number of ICMP Neighbor Solicit messages sent by the interface.
neighbor advertisement messages	The number of ICMP Router Advertisement messages sent by the interface.
redirect messages	The number of Redirect messages sent. For a host, this object will always be zero, since hosts do not send redirects.
group membership query messages	The number of ICMPv6 Group Membership Query messages sent by the interface.
group membership response messages	The number of ICMPv6 Group Membership Response messages sent.
group membership reduction messages	The number of ICMPv6 Group Membership Reduction messages sent.

Table 216: show ipv6 traffic - display description (Continued)

Field	Description
multicast listener discovery version 2 reports	The number of MLDv2 reports sent by the interface.
<i>UDP Statistics</i>	
input	The total number of UDP datagrams delivered to UDP users.
no port errors	The total number of received UDP datagrams for which there was no application at the destination port.
other errors	The number of received UDP datagrams that could not be delivered for reasons other than the lack of an application at the destination port.
output	The total number of UDP datagrams sent from this entity.

clear ipv6 traffic This command resets IPv6 traffic counters.

COMMAND MODE

Privileged Exec

COMMAND USAGE

This command resets all of the counters displayed by the show ipv6 traffic command.

EXAMPLE

```

Console#clear ipv6 traffic
Console#

```

ping6 This command sends (IPv6) ICMP echo request packets to another node on the network.

SYNTAX

ping6 {*ipv6-address* | *host-name*} [**count** *count*] [**size** *size*]

ipv6-address - The IPv6 address of a neighbor device. You can specify either a link-local or global unicast address formatted according to RFC 2373 "IPv6 Addressing Architecture," using 8 colon-separated 16-bit hexadecimal values. One double colon may be used in the address to indicate the appropriate number of zeros required to fill the undefined fields.

host-name - A host name string which can be resolved into an IPv6 address through a domain name server.

count - Number of packets to send. (Range: 1-16)

size - Number of bytes in a packet. (Range: 48-18024 bytes)
The actual packet size will be eight bytes larger than the size specified because the router adds header information.

DEFAULT SETTING

count: 5
size: 100 bytes

COMMAND MODE

Privileged Exec

COMMAND USAGE

- ◆ Use the **ping6** command to see if another site on the network can be reached, or to evaluate delays over the path.
- ◆ The same link-local address may be used by different interfaces/nodes in different zones (RFC 4007). Therefore, when specifying a link-local address, include zone-id information indicating the VLAN identifier after the % delimiter. For example, FE80::7272%1 identifies VLAN 1 as the interface from which the ping is sent.
- ◆ When pinging a host name, be sure the DNS server has been enabled (see [page 1402](#)). If necessary, local devices can also be specified in the DNS static host table (see [page 1404](#)).
- ◆ When using ping6 with a host name, the switch first attempts to resolve the alias into an IPv6 address before trying to resolve it into an IPv4 address.

EXAMPLE

```
Console#ping6 FE80::2E0:CFF:FE00:FC%1/64
Type ESC to abort.
PING to FE80::2E0:CFF:FE00:FC%1/64, by 5 32-byte payload ICMP packets,
  timeout is 3 seconds
response time: 20 ms    [FE80::2E0:CFF:FE00:FC] seq_no: 1
response time: 0 ms    [FE80::2E0:CFF:FE00:FC] seq_no: 2
response time: 0 ms    [FE80::2E0:CFF:FE00:FC] seq_no: 3
response time: 0 ms    [FE80::2E0:CFF:FE00:FC] seq_no: 4
response time: 0 ms    [FE80::2E0:CFF:FE00:FC] seq_no: 5
Ping statistics for FE80::2E0:CFF:FE00:FC%1/64:
  5 packets transmitted, 5 packets received (100%), 0 packets lost (0%)
Approximate round trip times:
  Minimum = 0 ms, Maximum = 20 ms, Average = 4 ms
Console#
```

traceroute6 This command shows the route packets take to the specified destination.

SYNTAX

```
traceroute6 {ipv6-address | host-name}
[max-failures failure-count]
```

ipv6-address - The IPv6 address of a neighbor device. You can specify either a link-local or global unicast address formatted according to RFC 2373 "IPv6 Addressing Architecture," using 8 colon-separated 16-bit hexadecimal values. One double colon may

be used in the address to indicate the appropriate number of zeros required to fill the undefined fields.

host-name - A host name string which can be resolved into an IPv6 address through a domain name server.

failure-count - The maximum number of failures before which the trace route is terminated. (Range: 1-255)

DEFAULT SETTING

Maximum failures: 5

COMMAND MODE

Privileged Exec

COMMAND USAGE

- ◆ Use the **traceroute6** command to determine the path taken to reach a specified destination.
- ◆ The same link-local address may be used by different interfaces/nodes in different zones (RFC 4007). Therefore, when specifying a link-local address, include zone-id information indicating the VLAN identifier after the % delimiter. For example, FE80::7272%1 identifies VLAN 1 as the interface from which the trace route is sent.
- ◆ A trace terminates when the destination responds, when the maximum timeout (TTL) is exceeded, or the maximum number of hops is exceeded.
- ◆ The traceroute command first sends probe datagrams with the TTL value set at one. This causes the first router to discard the datagram and return an error message. The trace function then sends several probe messages at each subsequent TTL level and displays the round-trip time for each message. Not all devices respond correctly to probes by returning an "ICMP port unreachable" message. If the timer goes off before a response is returned, the trace function prints a series of asterisks and the "Request Timed Out" message. A long sequence of these messages, terminating only when the maximum timeout has been reached, may indicate this problem with the target device.

EXAMPLE

```

Console#traceroute6 FE80::2E0:CFE:FE9C:CA10%1/64
Press "ESC" to abort.

Traceroute to FE80::2E0:CFE:FE9C:CA10%1/64, 30 hops max, timeout is 3
seconds, 5 max failure(s) before termination.

Hop Packet 1 Packet 2 Packet 3 IPv6 Address
-----
 1 <10 ms <10 ms <10 ms FE80::2E0:CFE:FE9C:CA10%1/64

Trace completed.
Console#

```

Neighbor Discovery

ipv6 nd dad attempts This command configures the number of consecutive neighbor solicitation messages sent on an interface during duplicate address detection. Use the **no** form to restore the default setting.

SYNTAX

ipv6 nd dad attempts *count*

no ipv6 nd dad attempts

count - The number of neighbor solicitation messages sent to determine whether or not a duplicate address exists on this interface. (Range: 0-600)

DEFAULT SETTING

3

COMMAND MODE

Interface Configuration (VLAN)

COMMAND USAGE

- ◆ Configuring a value of 0 disables duplicate address detection.
- ◆ Duplicate address detection determines if a new unicast IPv6 address already exists on the network before it is assigned to an interface.
- ◆ Duplicate address detection is stopped on any interface that has been suspended (see the [vlan](#) command). While an interface is suspended, all unicast IPv6 addresses assigned to that interface are placed in a “pending” state. Duplicate address detection is automatically restarted when the interface is administratively re-activated.
- ◆ An interface that is re-activated restarts duplicate address detection for all unicast IPv6 addresses on the interface. While duplicate address detection is performed on the interface’s link-local address, the other IPv6 addresses remain in a “tentative” state. If no duplicate link-local address is found, duplicate address detection is started for the remaining IPv6 addresses.
- ◆ If a duplicate address is detected, it is set to “duplicate” state, and a warning message is sent to the console. If a duplicate link-local address is detected, IPv6 processes are disabled on the interface. If a duplicate global unicast address is detected, it is not used. All configuration commands associated with a duplicate address remain configured while the address is in “duplicate” state.
- ◆ If the link-local address for an interface is changed, duplicate address detection is performed on the new link-local address, but not for any of the IPv6 global unicast addresses already associated with the interface.

EXAMPLE

The following configures five neighbor solicitation attempts for addresses configured on VLAN 1. The `show ipv6 interface` command indicates that the duplicate address detection process is still on-going.

```

Console(config)#interface vlan 1
Console(config-if)#ipv6 nd dad attempts 5
Console(config-if)#end
Console#show ipv6 interface
VLAN 1 is up
IPv6 is enabled
Link-local address:
  fe80::200:e8ff:fe90:0/64
Global unicast address(es):
  2009:db9:2229::79, subnet is 2009:db9:2229:0::/64
Joined group address(es):
  ff01::1/16
  ff02::1/16
  ff02::1:ff00:79/104
  ff02::1:ff90:0/104
IPv6 link MTU is 1500 bytes.
ND DAD is enabled, number of DAD attempts: 5.
ND retransmit interval is 1000 milliseconds
ND advertised retransmit interval is 0 milliseconds
ND reachable time is 30000 milliseconds
ND advertised reachable time is 0 milliseconds
ND advertised router lifetime is 1800 seconds

Console#

```

RELATED COMMANDS

[ipv6 nd ns-interval \(1453\)](#)
[show ipv6 neighbors \(1457\)](#)

ipv6 nd ns-interval This command configures the interval between transmitting IPv6 neighbor solicitation messages on an interface. Use the **no** form to restore the default value.

SYNTAX

ipv6 nd ns-interval *milliseconds*

no ipv6 nd ns-interval

milliseconds - The interval between transmitting IPv6 neighbor solicitation messages. (Range: 1000-3600000)

DEFAULT SETTING

1000 milliseconds is used for neighbor discovery operations
0 milliseconds is advertised in router advertisements

COMMAND MODE

Interface Configuration (VLAN)

COMMAND USAGE

- ◆ When a non-default value is configured, the specified interval is used both for router advertisements and by the router itself.
- ◆ This command specifies the interval between transmitting neighbor solicitation messages when resolving an address, or when probing the reachability of a neighbor. Therefore, avoid using very short intervals for normal IPv6 operations.
- ◆ Setting the neighbor solicitation interval to 0 means that the configured time is unspecified by this router.

EXAMPLE

The following sets the interval between sending neighbor solicitation messages to 30000 milliseconds:

```
Console(config)#interface vlan 1
Console(config)#ipv6 nd ns-interval 30000
Console(config)#end
Console#show ipv6 interface
VLAN 1 is up
IPv6 is enabled
Link-local address:
 fe80::200:e8ff:fe90:0/64
Global unicast address(es):
 2009:db9:2229::79, subnet is 2009:db9:2229:0::/64
Joined group address(es):
 ff01::1/16
 ff02::1/16
 ff02::1:ff00:79/104
 ff02::1:ff90:0/104
IPv6 link MTU is 1500 bytes.
ND DAD is enabled, number of DAD attempts: 5.
ND retransmit interval is 1000 milliseconds
ND advertised retransmit interval is 0 milliseconds
ND reachable time is 30000 milliseconds
ND advertised reachable time is 0 milliseconds
ND advertised router lifetime is 1800 seconds

Console#
```

RELATED COMMANDS

[show running-config \(729\)](#)

ipv6 nd rguard This command blocks incoming Router Advertisement and Router Redirect packets. Use the no form to disable this feature.

SYNTAX

[no] ipv6 nd rguard

DEFAULT SETTING

Disabled

COMMAND MODE

Interface Configuration (Ethernet, Port Channel)

COMMAND USAGE

- ◆ IPv6 Router Advertisements (RA) convey information that enables nodes to auto-configure on the network. This information may include the default router address taken from the observed source address of the RA message, as well as on-link prefix information. However, unintended misconfigurations, or possibly malicious attacks on the network, may lead to bogus RAs being sent, which in turn can cause operational problems for hosts on the network.
- ◆ This command can be used to block RAs and Router Redirect (RR) messages on the specified interface. Determine which interfaces are connected to known routers, and enable RA Guard on all other untrusted interfaces.

EXAMPLE

```

Console(config)#interface ethernet 1/1
Console(config-if)#ipv6 nd rguard
Console(config-if)#

```

**ipv6 nd
reachable-time**

This command configures the amount of time that a remote IPv6 node is considered reachable after some reachability confirmation event has occurred.

SYNTAX

ipv6 nd reachable-time *milliseconds*

no ipv6 nd reachable-time

milliseconds - The time that a node can be considered reachable after receiving confirmation of reachability.
(Range: 0-3600000)

DEFAULT SETTING

30000 milliseconds is used for neighbor discovery operations
0 milliseconds is advertised in router advertisements

COMMAND MODE

Interface Configuration (VLAN)

COMMAND USAGE

- ◆ The time limit configured by this parameter allows the router to detect unavailable neighbors. During the neighbor discover process, an IPv6 node will multicast neighbor solicitation messages to search for neighbor nodes. For a neighbor node to be considered reachable, it must respond to the neighbor soliciting node with a neighbor advertisement message to become a confirmed neighbor, after which the reachable timer will be considered in effect for subsequent unicast IPv6 layer communications.

- ◆ This time limit is included in all router advertisements sent out through an interface, ensuring that nodes on the same link use the same time value.
- ◆ Setting the time limit to 0 means that the configured time is unspecified by this router.

EXAMPLE

The following sets the reachable time for a remote node to 1000 milliseconds:

```
Console(config)#interface vlan 1
Console(config)#pv6 nd reachable-time 1000
Console(config)#
```

clear ipv6 neighbors This command deletes all dynamic entries in the IPv6 neighbor discovery cache.

COMMAND MODE

Privileged Exec

EXAMPLE

The following deletes all dynamic entries in the IPv6 neighbor cache:

```
Console#clear ipv6 neighbors
Console#
```

show ipv6 nd raguard This command displays the configuration setting for RA Guard.

SYNTAX

show ipv6 nd raguard [*interface*]

interface

ethernet *unit/port*

unit - Unit identifier. (Range: 1)

port - Port number. (Range: 1-28/52)

port-channel *channel-id* (Range: 1-16)

COMMAND MODE

Privileged Exec

EXAMPLE

```

Console#show ipv6 nd raguard interface ethernet 1/1
Interface RA Guard
-----
Eth 1/ 1   Yes
Console#
    
```

show ipv6 neighbors

This command displays information in the IPv6 neighbor discovery cache.

SYNTAX

show ipv6 neighbors [**vlan** *vlan-id* | *ipv6-address*]

vlan-id - VLAN ID (Range: 1-4094)

ipv6-address - The IPv6 address of a neighbor device. You can specify either a link-local or global unicast address formatted according to RFC 2373 "IPv6 Addressing Architecture," using 8 colon-separated 16-bit hexadecimal values. One double colon may be used in the address to indicate the appropriate number of zeros required to fill the undefined fields.

DEFAULT SETTING

All IPv6 neighbor discovery cache entries are displayed.

COMMAND MODE

Privileged Exec

EXAMPLE

The following shows all known IPv6 neighbors for this switch:

```

Console#show ipv6 neighbors
State: I1 - Incomplete, I2 - Invalid, R - Reachable, S - Stale, D - Delay,
       P1 - Probe, P2 - Permanent, U - Unknown
IPv6 Address          Age      Link-layer Addr  State VLAN
FE80::2E0:CFF:FE9C:CA10 4        00-E0-0C-9C-CA-10  R    1
Console#
    
```

Table 217: show ipv6 neighbors - display description

Field	Description
IPv6 Address	IPv6 address of neighbor
Age	The time since the address was verified as reachable (in seconds). A static entry is indicated by the value "Permanent."
Link-layer Addr	Physical layer MAC address.

Table 217: show ipv6 neighbors - display description (Continued)

Field	Description
State	<p>The following states are used for dynamic entries:</p> <p>I1 (Incomplete) - Address resolution is being carried out on the entry. A neighbor solicitation message has been sent to the multicast address of the target, but it has not yet returned a neighbor advertisement message.</p> <p>I2 (Invalid) - An invalidated mapping. Setting the state to invalid disassociates the interface identified with this entry from the indicated mapping (RFC 4293).</p> <p>R (Reachable) - Positive confirmation was received within the last ReachableTime interval that the forward path to the neighbor was functioning. While in REACH state, the device takes no special action when sending packets.</p> <p>S (Stale) - More than the ReachableTime interval has elapsed since the last positive confirmation was received that the forward path was functioning. While in STALE state, the device takes no action until a packet is sent.</p> <p>D (Delay) - More than the ReachableTime interval has elapsed since the last positive confirmation was received that the forward path was functioning. A packet was sent within the last DELAY_FIRST_PROBE_TIME interval. If no reachability confirmation is received within this interval after entering the DELAY state, the switch will send a neighbor solicitation message and change the state to PROBE.</p> <p>P1 (Probe) - A reachability confirmation is actively sought by re-sending neighbor solicitation messages every RetransTimer interval until confirmation of reachability is received.</p> <p>U (Unknown) - Unknown state.</p> <p>The following states are used for static entries:</p> <p>I1 (Incomplete)-The interface for this entry is down.</p> <p>R (Reachable) - The interface for this entry is up. Reachability detection is not applied to static entries in the IPv6 neighbor discovery cache.</p> <p>P2 (Permanent) - Indicates a static entry.</p>
VLAN	VLAN interface from which the address was reached.

RELATED COMMANDS

[show mac-address-table \(1087\)](#)

ND SNOOPING

Neighbor Discover (ND) Snooping maintains an IPv6 prefix table and user address binding table. These tables can be used for stateless address auto-configuration or for address filtering by IPv6 Source Guard.

ND snooping maintains a binding table in the process of neighbor discovery. When it receives an Neighbor Solicitation (NS) packet from a host, it creates a new binding. If it subsequently receives a Neighbor Advertisement (NA) packet, this means that the address is already being used by another host, and the binding is therefore deleted. If it does not receive an NA packet after a timeout period, the binding will be bound to the original host. ND snooping can also maintain a prefix table used for stateless address auto-configuration by monitoring Router Advertisement (RA) packets sent from neighboring routers.

ND snooping can also detect if an IPv6 address binding is no longer valid. When a binding has been timed out, it checks to see if the host still exists by sending an NS packet to the target host. If it receives an NA packet in response, it knows that the target still exists and updates the lifetime of the binding; otherwise, it deletes the binding.

This section describes commands used to configure ND Snooping.

Table 218: ND Snooping Commands

Command	Function	Mode
<code>ipv6 nd snooping</code>	Enables ND snooping globally or on a specified VLAN or range of VLANs	GC
<code>ipv6 nd snooping auto-detect</code>	Enables automatic validation of binding table entries by periodically sending NS messages and awaiting NA replies	GC
<code>ipv6 nd snooping auto-detect retransmit count</code>	Sets the number of times to send an NS message to determine if a binding is still valid	GC
<code>ipv6 nd snooping auto-detect retransmit interval</code>	Sets the interval between sending NS messages to determine if a binding is still valid	GC
<code>ipv6 nd snooping prefix timeout</code>	Sets the time to wait for an RA message before deleting an entry in the prefix table	GC
<code>ipv6 nd snooping max-binding</code>	Sets the maximum number of address entries which can be bound to a port	IC
<code>ipv6 nd snooping trust</code>	Configures a port as a trusted interface from which prefix information in RA messages can be added to the prefix table, or NS messages can be forwarded without validation	IC
<code>clear ipv6 nd snooping binding</code>	Clears all entries in the address binding table	PE
<code>clear ipv6 nd snooping prefix</code>	Clears all entries in the prefix table	PE
<code>show ipv6 nd snooping</code>	Shows configuration settings for ND snooping	PE
<code>show ipv6 nd snooping binding</code>	Shows entries in the binding table	PE
<code>show ipv6 nd snooping prefix</code>	Show entries in the prefix table	PE

ipv6 nd snooping This command enables ND snooping globally or on a specified VLAN or range of VLANs. Use the **no** form to disable this feature.

SYNTAX

[no] ipv6 nd snooping [vlan {*vlan-id* | *vlan-range*}]

vlan-id - VLAN ID. (Range: 1-4094)

vlan-range - A consecutive range of VLANs indicated by the use a hyphen, or a random group of VLANs with each entry separated by a comma.

DEFAULT SETTING

Disabled

COMMAND MODE

Global Configuration

COMMAND USAGE

- ◆ Use this command without any keywords to enable ND snooping globally on the switch. Use the VLAN keyword to enable ND snooping on a specific VLAN or a range of VLANs.
- ◆ Once ND snooping is enabled both globally and on the required VLANs, the switch will start monitoring RA messages to build an address prefix table as described below:
 - If an RA message is received on an untrusted interface, it is dropped. If received on a trusted interface, the switch adds an entry in the prefix table according to the Prefix Information option in the RA message. The prefix table records prefix, prefix length, valid lifetime, as well as the VLAN and port interface which received the message.
 - If an RA message is not received updating a table entry with the same prefix for a specified timeout period, the entry is deleted.
- ◆ Once ND snooping is enabled both globally and on the required VLANs, the switch will start monitoring NS messages to build a dynamic user binding table for use in Duplicate Address Detection (DAD) or for use by other security filtering protocols (e.g., IPv6 Source Guard) as described below:
 - If an NS message is received on a trusted interface, it is forwarded without further processing.
 - If an NS message is received on an untrusted interface, and the address prefix does not match any entry in the prefix table, it drops the packet.

If the message does match an entry in the prefix table, it adds an entry to the dynamic user binding table after a fixed delay, and forwards the packet. Each entry in the dynamic binding table includes the link-layer address, IPv6 address, lifetime, as well as the VLAN and port interface which received the message.
 - If an RA message is received in response to the original NS message (indicating a duplicate address) before the dynamic binding timeout period expires, the entry is deleted. Otherwise, when the timeout expires, the entry is dropped if the auto-detection process is not enabled.
 - If the auto-detection process is enabled, the switch periodically sends an NS message to determine if the client still exists. If it does not receive an RA message in response after the configured timeout, the entry is dropped. If the switch receives an RA message before the timeout expires, it resets the lifetime for the dynamic binding, and the auto-detection process resumes.

EXAMPLE

This example enables ND snooping globally and on VLAN 1.

```
Console(config)#ipv6 nd snooping
Console(config)#ipv6 nd snooping vlan 1
Console(config)#
```

**ipv6 nd snooping
auto-detect**

This command enables automatic validation of dynamic user binding table entries by periodically sending NS messages and awaiting NA replies. Use the **no** form to disable this feature.

SYNTAX

[no] ipv6 nd snooping auto-detect

DEFAULT SETTING

Disabled

COMMAND MODE

Global Configuration

COMMAND USAGE

If auto-detection is enabled, the switch periodically sends an NS message to determine if a client listed in the dynamic binding table still exists. If it does not receive an RA message in response after the configured timeout, the entry is dropped. If the switch receives an RA message before the timeout expires, it resets the lifetime for the dynamic binding, and the auto-detection process resumes.

EXAMPLE

```
Console(config)#ipv6 nd snooping auto-detect
Console(config)#
```

**ipv6 nd snooping
auto-detect
retransmit count**

This command sets the number of times the auto-detection process sends an NS message to determine if a dynamic user binding is still valid. Use the **no** form to restore the default setting.

SYNTAX

ipv6 nd snooping auto-detect retransmit count *retransmit-times*

no ipv6 nd snooping auto-detect retransmit count

retransmit-times – The number of times to send an NS message to determine if a client still exists. (Range: 1-5)

DEFAULT SETTING

3

COMMAND MODE

Global Configuration

COMMAND USAGE

The timeout after which the switch will delete a dynamic user binding if no RA message is received is set to the retransmit count x the retransmit interval (see the [ipv6 nd snooping auto-detect retransmit interval](#) command). Based on the default settings, this is 3 seconds.

EXAMPLE

```
Console(config)#ipv6 nd snooping auto-detect retransmit count 5  
Console(config)#
```

ipv6 nd snooping auto-detect retransmit interval

This command sets the interval between which the auto-detection process sends NS messages to determine if a dynamic user binding is still valid. Use the **no** form to restore the default setting.

SYNTAX

ipv6 nd snooping auto-detect retransmit interval
retransmit-interval

no ipv6 nd snooping auto-detect retransmit interval

retransmit-interval – The interval between which the switch sends an NS message to determine if a client still exists. (Range: 1-10 seconds)

DEFAULT SETTING

1 second

COMMAND MODE

Global Configuration

COMMAND USAGE

The timeout after which the switch will delete a dynamic user binding if no RA message is received is set to the retransmit count (see the [ipv6 nd snooping auto-detect retransmit count](#) command) x the retransmit interval. Based on the default settings, this is 3 seconds.

EXAMPLE

```
Console(config)#ipv6 nd snooping auto-detect retransmit interval 5  
Console(config)#
```

ipv6 nd snooping prefix timeout This command sets the time to wait for an RA message before deleting an entry in the prefix table. Use the **no** form to restore the default setting.

SYNTAX

ipv6 nd snooping prefix timeout *timeout*

no ipv6 nd snooping prefix timeout

timeout – The time to wait for an RA message to confirm that a prefix entry is still valid. (Range: 3-1800 seconds)

DEFAULT SETTING

Set to the valid lifetime field in received RA packet

COMMAND MODE

Global Configuration

COMMAND USAGE

If ND snooping is enabled and an RA message is received on a trusted interface, the switch will add an entry in the prefix table based upon the Prefix Information contained in the message. If an RA message is not received for a table entry with the same prefix for the specified timeout period, the entry is deleted.

EXAMPLE

```
Console(config)#ipv6 nd snooping prefix timeout 200
Console(config)#
```

ipv6 nd snooping max-binding This command sets the maximum number of address entries in the dynamic user binding table which can be bound to a port. Use the **no** form to restore the default setting.

SYNTAX

ipv6 nd snooping max-binding *max-bindings*

no ipv6 nd snooping max-binding

max-bindings – The maximum number of address entries in the dynamic user binding table which can be bound to a port. (Range: 1-5)

DEFAULT SETTING

5

COMMAND MODE

Interface Configuration (Ethernet, Port Channel)

EXAMPLE

```
Console(config)#ipv6 nd snooping prefix timeout 200  
Console(config)#
```

ipv6 nd snooping trust

This command configures a port as a trusted interface from which prefix information in RA messages can be added to the prefix table, or NS messages can be forwarded without validation. Use the **no** form to restore the default setting.

SYNTAX

[no] ipv6 nd snooping trust

DEFAULT SETTING

Not trusted

COMMAND MODE

Interface Configuration (Ethernet, Port Channel)

COMMAND USAGE

- ◆ In general, interfaces facing toward to the network core, or toward routers supporting the Network Discovery protocol, are configured as trusted interfaces.
- ◆ RA messages received from a trusted interface are added to the prefix table and forwarded toward their destination.
- ◆ NS messages received from a trusted interface are forwarded toward their destination. Nothing is added to the dynamic user binding table.

EXAMPLE

```
Console(config)#interface ethernet 1/1  
Console(config-if)#ipv6 nd snooping trust  
Console(config-if)#
```

clear ipv6 nd snooping binding

This command clears all entries in the dynamic user address binding table.

SYNTAX

clear ipv6 nd snooping binding

COMMAND MODE

Privileged Exec

EXAMPLE

```

Console#clear ipv6 nd snooping binding
Console#show ipv6 nd snooping binding
MAC Address      IPv6 Address                               Lifetime      VLAN Interface
-----
Console#
    
```

clear ipv6 nd snooping prefix

This command clears all entries in the address prefix table.

SYNTAX

clear ipv6 nd snooping prefix [interface vlan *vlan-id*]
vlan-id - VLAN ID. (Range: 1-4094)

COMMAND MODE

Privileged Exec

EXAMPLE

```

Console#clear ipv6 nd snooping prefix
Console#show ipv6 nd snooping prefix
Prefix entry timeout: (seconds)
Prefix          Len Valid-Time Expire      VLAN Interface
-----
Console#
    
```

show ipv6 nd snooping

This command shows the configuration settings for ND snooping.

SYNTAX

show ipv6 nd snooping

COMMAND MODE

Privileged Exec

EXAMPLE

```

Console#show ipv6 nd snooping
Global ND Snooping status: enabled
ND Snooping auto-detection: disabled
ND Snooping auto-detection retransmit count: 3
ND Snooping auto-detection retransmit interval: 1 (second)
ND Snooping is configured on the following VLANs:
VLAN 1,
Interface      Trusted      Max-binding
-----
Eth 1/1        Yes          1
Eth 1/2        No           5
Eth 1/3        No           5
Eth 1/4        No           5
Eth 1/5        No           5
    
```

:

show ipv6 nd snooping binding

This command shows all entries in the dynamic user binding table.

SYNTAX

show ipv6 nd snooping binding

COMMAND MODE

Privileged Exec

EXAMPLE

```
Console#show ipv6 nd snooping binding
MAC Address      IPv6 Address      Lifetime  VLAN Interface
-----
0013-49aa-3926  2001:b001::211:95ff:fe84:cb9e  100      1 Eth 1/1
0012-cf01-0203  2001::1           3400     2 Eth 1/2
Console#
```

show ipv6 nd snooping prefix

This command shows all entries in the address prefix table.

SYNTAX

show ipv6 nd snooping prefix [interface vlan *vlan-id*]

vlan-id - VLAN ID. (Range: 1-4094)

COMMAND MODE

Privileged Exec

EXAMPLE

```
Console#show ipv6 nd snooping prefix
Prefix entry timeout: 100 (second)
Prefix      Len Valid-Time Expire  VLAN Interface
-----
2001:b000:: 64   2592000  100   1 Eth 1/1
2001::      64    600     34    2 Eth 1/2
Console#
```

After network interfaces are configured for the switch, the paths used to send traffic between different interfaces must be set. If routing is enabled on the switch, traffic will automatically be forwarded between all of the local subnetworks. However, to forward traffic to devices on other subnetworks, either configure fixed paths with static routing commands, or enable a dynamic routing protocol that exchanges information with other routers on the network to automatically determine the best path to any subnetwork.

This section includes commands for both static and dynamic routing. These commands are used to connect between different local subnetworks or to connect the router to the enterprise network.

Table 203: IP Routing Commands

Command Group	Function
Global Routing Configuration	Configures global parameters for static and dynamic routing, displays the routing table and statistics for protocols used to exchange routing information

GLOBAL ROUTING CONFIGURATION

Table 204: Global Routing Configuration Commands

Command	Function	Mode
ip route	Configures static routes	GC
ip sw-route	Uses software to process static routes	GC
show ip route	Displays specified entries in the routing table	PE
show ip route database	Displays static or dynamically learned entries in the routing table	PE
show ip route summary	Displays summary information for the routing table	PE

IPv4 Commands

ip route This command configures static routes. Use the **no** form to remove static routes.

SYNTAX

ip route *destination-ip netmask next-hop [distance]*

no ip route {*destination-ip netmask next-hop | **}

destination-ip – IP address of the destination network, subnetwork, or host.

netmask – Network mask for the associated IP subnet. This mask identifies the host address bits used for routing to specific subnets.

next-hop – IP address of the next hop router used for this route.

distance – An administrative distance indicating that this route can be overridden by dynamic routing information if the distance of the dynamic route is less than that configured for the static route. (Range: 1-255, Default: 1)

* – Removes all static routing table entries.

DEFAULT SETTING

No static routes are configured.

COMMAND MODE

Global Configuration

COMMAND USAGE

- ◆ Up to 512 static routes can be configured.
- ◆ If an administrative distance is defined for a static route, and the same destination can be reached through a dynamic route at a lower administration distance, then the dynamic route will be used.
- ◆ If both static and dynamic paths have the same lowest cost, the first route stored in the routing table, either statically configured or dynamically learned via a routing protocol, will be used.

EXAMPLE

This example forwards all traffic for subnet 192.168.1.0 to the gateway router 192.168.5.254, using the default metric of 1.

```
Console(config)#ip route 192.168.1.0 255.255.255.0 192.168.5.254
Console(config)#
```

ip sw-route This command using software to process static routes. Us the **no** form to disable this function.

SYNTAX

[no] ip sw-route

DEFAULT SETTING

Hardware is used to process static routes.

COMMAND MODE

Global Configuration

COMMAND USAGE

- ◆ Due to a hardware limitation on the ECS4110-52T, static routes do not work with DiffServ. Hardware processing of static routes is enabled by default. If you must use DiffServ, then use this command to configure the switch to process static routes through software.
- ◆ The switch can only can only process 200~300 routing packets/second. So, it should only be used as L3 switch in this mode for light routing requirements.

EXAMPLE

```
Console(config)#ip sw-route
Console(config)#
```

show ip route This command displays information in the Forwarding Information Base (FIB).

SYNTAX

show ip route [connected | database | static | summary]

connected – Displays all currently connected entries.

database – All known routes, including inactive routes.

static – Displays all static entries.

summary – Displays a brief list of summary information about entries in the routing table, including the maximum number of entries supported, the number of connected routes, the total number of routes currently stored in the routing table, and the number of entries in the FIB.

COMMAND MODE

Privileged Exec

COMMAND USAGE

- ◆ The FIB contains information required to forward IP traffic. It contains the interface identifier and next hop information for each reachable

destination network prefix based on the IP routing table. When routing or topology changes occur in the network, the routing table is updated, and those changes are immediately reflected in the FIB.

The FIB is distinct from the routing table (or, Routing Information Base), which holds all routing information received from routing peers. The forwarding information base contains unique paths only. It does not contain any secondary paths. A FIB entry consists of the minimum amount of information necessary to make a forwarding decision on a particular packet. The typical components within a forwarding information base entry are a network prefix, a router port identifier, and next hop information.

- ◆ This command only displays routes which are currently accessible for forwarding. The router must be able to directly reach the next hop, so the VLAN interface associated with any dynamic or static route entry must be up. Note that routes currently not accessible for forwarding, may still be displayed by using the [show ip route database](#) command.

EXAMPLE

```
Console#show ip route
Codes: C - connected, S - static, R - RIP, B - BGP
       O - OSPF, IA - OSPF inter area
       N1 - OSPF NSSA external type 1, N2 - OSPF NSSA external type 2
       E1 - OSPF external type 1, E2 - OSPF external type 2
       i - IS-IS, L1 - IS-IS level-1, L2 - IS-IS level-2, ia - IS-IS inter area
       * - candidate default

C       127.0.0.0/8 is directly connected, lo
C       192.168.1.0/24 is directly connected, VLAN1
Console#
```

show ip route database This command displays entries in the Routing Information Base (RIB).

COMMAND MODE

Privileged Exec

COMMAND USAGE

The RIB contains all available routes learned through dynamic routing protocols, directly attached networks, and any additionally configured routes such as static routes. The RIB contains the set of all available routes from which optimal entries are selected for use by the Forwarding Information Base (see Command Usage under the [show ip route](#) command).

EXAMPLE

```
Console#show ip route database
Codes: C - connected, S - static, R - RIP, B - BGP
       O - OSPF, IA - OSPF inter area
       N1 - OSPF NSSA external type 1, N2 - OSPF NSSA external type 2
       E1 - OSPF external type 1, E2 - OSPF external type 2
       i - IS-IS, L1 - IS-IS level-1, L2 - IS-IS level-2, ia - IS-IS inter area
```

```
> - selected route, * - FIB route, p - stale info  
C    *> 127.0.0.0/8 is directly connected, lo0  
C    *> 192.168.1.0/24 is directly connected, VLAN1  
Console#
```

show ip route summary This command displays summary information for the routing table.

COMMAND MODE
Privileged Exec

EXAMPLE

In the following example, the numeric identifier following the named routing table (that is, the Forwarding Information Base) is the FIB ID.

```
Console#show ip route summary  
IP routing table name is Default-IP-Routing-Table(0)  
IP routing table maximum-paths is 4  
Connected          2  
Total              2  
FIB                0  
Console#
```

SECTION IV

APPENDICES

This section provides additional information and includes these items:

- ◆ ["Software Specifications" on page 1475](#)
- ◆ ["Troubleshooting" on page 1479](#)
- ◆ ["License Information" on page 1481](#)

SOFTWARE FEATURES

MANAGEMENT AUTHENTICATION Local, RADIUS, TACACS+, Port Authentication (802.1X), HTTPS, SSH, Port Security, IP Filter, DHCP Snooping

CLIENT ACCESS CONTROL Access Control Lists (512 rules), Port Authentication (802.1X), MAC Authentication, Port Security, DHCP Snooping, IP Source Guard

PORT CONFIGURATION 100BASE-FX: 100 Mbps at full duplex (SFP)
1000BASE-T: 10/100 Mbps at half/full duplex, 1000 Mbps at full duplex
1000BASE-SX/LX/LH - 1000 Mbps at full duplex (SFP)

FLOW CONTROL Full Duplex: IEEE 802.3-2005
Half Duplex: Back pressure

STORM CONTROL Broadcast, multicast, or unicast traffic throttled above a critical threshold

PORT MIRRORING 50 sessions, one or more source ports to one destination port

RATE LIMITS Input/Output Limits
Range configured per port

PORT TRUNKING Static trunks (Cisco EtherChannel compliant)
Dynamic trunks (Link Aggregation Control Protocol)

SPANNING TREE ALGORITHM Spanning Tree Protocol (STP, IEEE 802.1D-2004)
Rapid Spanning Tree Protocol (RSTP, IEEE 802.1D-2004)
Multiple Spanning Tree Protocol (MSTP, IEEE 802.1D-2004)

VLAN SUPPORT Up to 256 groups; port-based, protocol-based, tagged (802.1Q), private VLANs, voice VLANs, IP subnet, MAC-based, GVRP for automatic VLAN learning

CLASS OF SERVICE Supports four levels of priority
Strict, Shaped Deficit Weighted Round Robin, or strict-WRR queuing
Layer 3/4 priority mapping: IP DSCP

QUALITY OF SERVICE DiffServ (IPv4/v6) supports class maps, policy maps, and service policies

MULTICAST FILTERING IGMP Snooping (Layer 2)
Multicast VLAN Registration

ADDITIONAL FEATURES BOOTP Client
DHCP Client
DNS Client, Proxy
LLDP (Link Layer Discover Protocol)
RMON (Remote Monitoring, groups 1,2,3,9)
SMTP Email Alerts
SNMP (Simple Network Management Protocol)
SNTP (Simple Network Time Protocol)

MANAGEMENT FEATURES

IN-BAND MANAGEMENT Telnet, web-based HTTP or HTTPS, SNMP manager, or Secure Shell

**OUT-OF-BAND
MANAGEMENT** RS-232 DB-9 console port

SOFTWARE LOADING HTTP, FTP or TFTP in-band, or XModem out-of-band

SNMP Management access via MIB database
Trap management to specified hosts

RMON Groups 1, 2, 3, 9 (Statistics, History, Alarm, Event)

STANDARDS

IEEE 802.1AB Link Layer Discovery Protocol
IEEE 802.1D-2004 Spanning Tree Algorithm and traffic priorities
Spanning Tree Protocol
Rapid Spanning Tree Protocol
Multiple Spanning Tree Protocol
IEEE 802.1p Priority tags
IEEE 802.1Q VLAN
IEEE 802.1v Protocol-based VLANs
IEEE 802.1X Port Authentication
IEEE 802.3-2005
Ethernet, Fast Ethernet, Gigabit Ethernet
Link Aggregation Control Protocol (LACP)
Full-duplex flow control (ISO/IEC 8802-3)
IEEE 802.3ac VLAN tagging
DHCP Client (RFC 2131)
DHCPv6 Client (RFC 3315)
HTTPS
ICMP (RFC 792)
IGMP (RFC 1112)
IGMPv2 (RFC 2236)
IGMPv3 (RFC 3376) - partial support
IPv4 IGMP (RFC 3228)
RADIUS+ (RFC 2618)
RMON (RFC 2819 groups 1,2,3,9)
SNMP (RFC 1157)
SNMPv2c (RFC 1901, 2571)
SNMPv3 (RFC DRAFT 2273, 2576, 3410, 3411, 3413, 3414, 3415)
SNTP (RFC 2030)
SSH (Version 2.0)
TELNET (RFC 854, 855, 856)
TFTP (RFC 1350)

MANAGEMENT INFORMATION BASES

Bridge MIB (RFC 1493)
DHCP Option for Civic Addresses Configuration Information (RFC 4776)
Differentiated Services MIB (RFC 3289)
DNS Resolver MIB (RFC 1612)
Entity MIB (RFC 2737)
Ether-like MIB (RFC 2665)
Extended Bridge MIB (RFC 2674)

Extensible SNMP Agents MIB (RFC 2742)
Forwarding Table MIB (RFC 2096)
IGMP MIB (RFC 2933)
Interface Group MIB (RFC 2233)
Interfaces Evolution MIB (RFC 2863)
IP Multicasting related MIBs
IPV6-MIB (RFC 2065)
IPV6-ICMP-MIB (RFC 2066)
IPV6-TCP-MIB (RFC 2052)
IPV6-UDP-MIB (RFC2054)
Link Aggregation MIB (IEEE 802.3ad)
MAU MIB (RFC 3636)
MIB II (RFC 1213)
P-Bridge MIB (RFC 2674P)
Port Access Entity MIB (IEEE 802.1X)
Port Access Entity Equipment MIB
Power Ethernet MIB (RFC 3621)
Private MIB
Q-Bridge MIB (RFC 2674Q)
Quality of Service MIB
RADIUS Authentication Client MIB (RFC 2621)
RMON MIB (RFC 2819)
RMON II Probe Configuration Group (RFC 2021, partial implementation)
SNMP Community MIB (RFC 3584)
SNMP Framework MIB (RFC 3411)
SNMP-MPD MIB (RFC 3412)
SNMP Target MIB, SNMP Notification MIB (RFC 3413)
SNMP User-Based SM MIB (RFC 3414)
SNMP View Based ACM MIB (RFC 3415)
SNMPv2 IP MIB (RFC 2011)
TACACS+ Authentication Client MIB
TCP MIB (RFC 2012)
Trap (RFC 1215)
UDP MIB (RFC 2013)

PROBLEMS ACCESSING THE MANAGEMENT INTERFACE
Table 205: Troubleshooting Chart

Symptom	Action
Cannot connect using Telnet, web browser, or SNMP software	<ul style="list-style-type: none"> ◆ Be sure the switch is powered up. ◆ Check network cabling between the management station and the switch. ◆ Check that you have a valid network connection to the switch and that the port you are using has not been disabled. ◆ Be sure you have configured the VLAN interface through which the management station is connected with a valid IP address, subnet mask and default gateway. ◆ Be sure the management station has an IP address in the same subnet as the switch's IP interface to which it is connected. ◆ If you are trying to connect to the switch via the IP address for a tagged VLAN group, your management station, and the ports connecting intermediate switches in the network, must be configured with the appropriate tag. ◆ If you cannot connect using Telnet, you may have exceeded the maximum number of concurrent Telnet/SSH sessions permitted. Try connecting again at a later time.
Cannot connect using Secure Shell	<ul style="list-style-type: none"> ◆ If you cannot connect using SSH, you may have exceeded the maximum number of concurrent Telnet/SSH sessions permitted. Try connecting again at a later time. ◆ Be sure the control parameters for the SSH server are properly configured on the switch, and that the SSH client software is properly configured on the management station. ◆ Be sure you have generated both an RSA and DSA public key on the switch, exported this key to the SSH client, and enabled SSH service. ◆ Be sure you have set up an account on the switch for each SSH user, including user name, authentication level, and password. ◆ Be sure you have imported the client's public key to the switch (if public key authentication is used).
Cannot access the on-board configuration program via a serial port connection	<ul style="list-style-type: none"> ◆ Be sure you have set the terminal emulator program to VT100 compatible, 8 data bits, 1 stop bit, no parity, and the baud rate set to 115200 bps. ◆ Check that the null-modem serial cable conforms to the pin-out connections provided in the Installation Guide.
Forgot or lost the password	<ul style="list-style-type: none"> ◆ Contact your local distributor.

USING SYSTEM LOGS

If a fault does occur, refer to the Installation Guide to ensure that the problem you encountered is actually caused by the switch. If the problem appears to be caused by the switch, follow these steps:

1. Enable logging.
2. Set the error messages reported to include all categories.
3. Enable SNMP.
4. Enable SNMP traps.
5. Designate the SNMP host that is to receive the error messages.
6. Repeat the sequence of commands or other actions that lead up to the error.
7. Make a list of the commands or circumstances that led to the fault. Also make a list of any error messages displayed.
8. Set up your terminal emulation software so that it can capture all console output to a file. Then enter the "show tech-support" command to record all system settings in this file.
9. Contact your distributor's service engineer, and send a detailed description of the problem, along with the file used to record your system settings.

For example:

```
Console(config)#logging on
Console(config)#logging history flash 7
Console(config)#snmp-server host 192.168.1.23
:
```

This product includes copyrighted third-party software subject to the terms of the GNU General Public License (GPL), GNU Lesser General Public License (LGPL), or other related free software licenses. The GPL code used in this product is distributed WITHOUT ANY WARRANTY and is subject to the copyrights of one or more authors. For details, refer to the section "The GNU General Public License" below, or refer to the applicable license as included in the source-code archive.

THE GNU GENERAL PUBLIC LICENSE

GNU GENERAL PUBLIC LICENSE

Version 2, June 1991

Copyright (C) 1989, 1991 Free Software Foundation, Inc.
59 Temple Place, Suite 330, Boston, MA 02111-1307 USA

Everyone is permitted to copy and distribute verbatim copies of this license document, but changing it is not allowed.

Preamble

The licenses for most software are designed to take away your freedom to share and change it. By contrast, the GNU General Public License is intended to guarantee your freedom to share and change free software--to make sure the software is free for all its users. This General Public License applies to most of the Free Software Foundation's software and to any other program whose authors commit to using it. (Some other Free Software Foundation software is covered by the GNU Library General Public License instead.) You can apply it to your programs, too.

When we speak of free software, we are referring to freedom, not price. Our General Public Licenses are designed to make sure that you have the freedom to distribute copies of free software (and charge for this service if you wish), that you receive source code or can get it if you want it, that you can change the software or use pieces of it in new free programs; and that you know you can do these things.

To protect your rights, we need to make restrictions that forbid anyone to deny you these rights or to ask you to surrender the rights. These restrictions translate to certain responsibilities for you if you distribute copies of the software, or if you modify it.

For example, if you distribute copies of such a program, whether gratis or for a fee, you must give the recipients all the rights that you have. You must make sure that they, too, receive or can get the source code. And you must show them these terms so they know their rights.

We protect your rights with two steps: (1) copyright the software, and (2) offer you this license which gives you legal permission to copy, distribute and/or modify the software.

Also, for each author's protection and ours, we want to make certain that everyone understands that there is no warranty for this free software. If the software is modified by someone else and passed on, we want its recipients to know that what they have is not the original, so that any problems introduced by others will not reflect on the original authors' reputations.

Finally, any free program is threatened constantly by software patents. We wish to avoid the danger that redistributors of a free program will individually obtain patent licenses, in effect making the program proprietary. To prevent this, we have made it clear that any patent must be licensed for everyone's free use or not licensed at all.

The precise terms and conditions for copying, distribution and modification follow.

GNU GENERAL PUBLIC LICENSE TERMS AND CONDITIONS FOR COPYING, DISTRIBUTION AND MODIFICATION

1. This License applies to any program or other work which contains a notice placed by the copyright holder saying it may be distributed under the terms of this General Public License. The "Program", below, refers to any such program or work, and a "work based on the Program" means either the Program or any derivative work under copyright law: that is to say, a work containing the Program or a portion of it, either verbatim or with modifications and/or translated into another language. (Hereinafter, translation is included without limitation in the term "modification".) Each licensee is addressed as "you".

Activities other than copying, distribution and modification are not covered by this License; they are outside its scope. The act of running the Program is not restricted, and the output from the Program is covered only if its contents constitute a work based on the Program (independent of having been made by running the Program). Whether that is true depends on what the Program does.

2. You may copy and distribute verbatim copies of the Program's source code as you receive it, in any medium, provided that you conspicuously and appropriately publish on each copy an appropriate copyright notice and disclaimer of warranty; keep intact all the notices that refer to this License and to the absence of any warranty; and give any other recipients of the Program a copy of this License along with the Program.

You may charge a fee for the physical act of transferring a copy, and you may at your option offer warranty protection in exchange for a fee.

3. You may modify your copy or copies of the Program or any portion of it, thus forming a work based on the Program, and copy and distribute such modifications or work under the terms of Section 1 above, provided that you also meet all of these conditions:
 - a) You must cause the modified files to carry prominent notices stating that you changed the files and the date of any change.
 - b) You must cause any work that you distribute or publish, that in whole or in part contains or is derived from the Program or any part thereof, to be licensed as a whole at no charge to all third parties under the terms of this License.
 - c) If the modified program normally reads commands interactively when run, you must cause it, when started running for such interactive use in the most ordinary way, to print or display an announcement including an appropriate copyright notice and a notice that there is no warranty (or else, saying that you provide a warranty) and that users may redistribute the program under these conditions, and telling the user how to view a copy of this License. (Exception: if the Program itself is interactive but does not normally print such an announcement, your work based on the Program is not required to print an announcement.)

These requirements apply to the modified work as a whole. If identifiable sections of that work are not derived from the Program, and can be reasonably considered independent and separate works in themselves, then this License, and its terms, do not apply to those sections when you distribute them as separate works. But when you distribute the same sections as part of a whole which is a work based on the Program, the distribution of the whole must be on the terms of this License, whose permissions for other licensees extend to the entire whole, and thus to each and every part regardless of who wrote it.

Thus, it is not the intent of this section to claim rights or contest your rights to work written entirely by you; rather, the intent is to exercise the right to control the distribution of derivative or collective works based on the Program.

In addition, mere aggregation of another work not based on the Program with the Program (or with a work based on the Program) on a volume of a storage or distribution medium does not bring the other work under the scope of this License.

4. You may copy and distribute the Program (or a work based on it, under Section 2) in object code or executable form under the terms of Sections 1 and 2 above provided that you also do one of the following:
 - a) Accompany it with the complete corresponding machine-readable source code, which must be distributed under the terms of Sections 1 and 2 above on a medium customarily used for software interchange; or,

- b) Accompany it with a written offer, valid for at least three years, to give any third party, for a charge no more than your cost of physically performing source distribution, a complete machine-readable copy of the corresponding source code, to be distributed under the terms of Sections 1 and 2 above on a medium customarily used for software interchange; or,
- c) Accompany it with the information you received as to the offer to distribute corresponding source code. (This alternative is allowed only for noncommercial distribution and only if you received the program in object code or executable form with such an offer, in accord with Subsection b above.)

The source code for a work means the preferred form of the work for making modifications to it. For an executable work, complete source code means all the source code for all modules it contains, plus any associated interface definition files, plus the scripts used to control compilation and installation of the executable. However, as a special exception, the source code distributed need not include anything that is normally distributed (in either source or binary form) with the major components (compiler, kernel, and so on) of the operating system on which the executable runs, unless that component itself accompanies the executable.

If distribution of executable or object code is made by offering access to copy from a designated place, then offering equivalent access to copy the source code from the same place counts as distribution of the source code, even though third parties are not compelled to copy the source along with the object code.

- 5. You may not copy, modify, sublicense, or distribute the Program except as expressly provided under this License. Any attempt otherwise to copy, modify, sublicense or distribute the Program is void, and will automatically terminate your rights under this License. However, parties who have received copies, or rights, from you under this License will not have their licenses terminated so long as such parties remain in full compliance.
- 6. You are not required to accept this License, since you have not signed it. However, nothing else grants you permission to modify or distribute the Program or its derivative works. These actions are prohibited by law if you do not accept this License. Therefore, by modifying or distributing the Program (or any work based on the Program), you indicate your acceptance of this License to do so, and all its terms and conditions for copying, distributing or modifying the Program or works based on it.
- 7. Each time you redistribute the Program (or any work based on the Program), the recipient automatically receives a license from the original licensor to copy, distribute or modify the Program subject to these terms and conditions. You may not impose any further restrictions on the recipients' exercise of the rights granted herein. You are not responsible for enforcing compliance by third parties to this License.
- 8. If, as a consequence of a court judgment or allegation of patent infringement or for any other reason (not limited to patent issues), conditions are imposed on you (whether by court order, agreement or otherwise) that contradict the conditions of this License, they do not excuse you from the conditions of this License. If you cannot distribute so as to satisfy simultaneously your obligations under this License and any other pertinent obligations, then as a consequence you may not distribute the Program at all. For example, if a patent license would not permit royalty-free redistribution of the Program by all those who receive copies directly or indirectly through you, then the only way you could satisfy both it and this License would be to refrain entirely from distribution of the Program.

If any portion of this section is held invalid or unenforceable under any particular circumstance, the balance of the section is intended to apply and the section as a whole is intended to apply in other circumstances.

It is not the purpose of this section to induce you to infringe any patents or other property right claims or to contest validity of any such claims; this section has the sole purpose of protecting the integrity of the free software distribution system, which is implemented by public license practices. Many people have made generous contributions to the wide range of software distributed through that system in reliance on consistent application of that system; it is up to the author/donor to decide if he or she is willing to distribute software through any other system and a licensee cannot impose that choice.

This section is intended to make thoroughly clear what is believed to be a consequence of the rest of this License.

9. If the distribution and/or use of the Program is restricted in certain countries either by patents or by copyrighted interfaces, the original copyright holder who places the Program under this License may add an explicit geographical distribution limitation excluding those countries, so that distribution is permitted only in or among countries not thus excluded. In such case, this License incorporates the limitation as if written in the body of this License.
10. The Free Software Foundation may publish revised and/or new versions of the General Public License from time to time. Such new versions will be similar in spirit to the present version, but may differ in detail to address new problems or concerns.

Each version is given a distinguishing version number. If the Program specifies a version number of this License which applies to it and "any later version", you have the option of following the terms and conditions either of that version or of any later version published by the Free Software Foundation. If the Program does not specify a version number of this License, you may choose any version ever published by the Free Software Foundation.
11. If you wish to incorporate parts of the Program into other free programs whose distribution conditions are different, write to the author to ask for permission. For software which is copyrighted by the Free Software Foundation, write to the Free Software Foundation; we sometimes make exceptions for this. Our decision will be guided by the two goals of preserving the free status of all derivatives of our free software and of promoting the sharing and reuse of software generally.

NO WARRANTY

1. BECAUSE THE PROGRAM IS LICENSED FREE OF CHARGE, THERE IS NO WARRANTY FOR THE PROGRAM, TO THE EXTENT PERMITTED BY APPLICABLE LAW. EXCEPT WHEN OTHERWISE STATED IN WRITING THE COPYRIGHT HOLDERS AND/OR OTHER PARTIES PROVIDE THE PROGRAM "AS IS" WITHOUT WARRANTY OF ANY KIND, EITHER EXPRESSED OR IMPLIED, INCLUDING, BUT NOT LIMITED TO, THE IMPLIED WARRANTIES OF MERCHANTABILITY AND FITNESS FOR A PARTICULAR PURPOSE. THE ENTIRE RISK AS TO THE QUALITY AND PERFORMANCE OF THE PROGRAM IS WITH YOU. SHOULD THE PROGRAM PROVE DEFECTIVE, YOU ASSUME THE COST OF ALL NECESSARY SERVICING, REPAIR OR CORRECTION.
2. IN NO EVENT UNLESS REQUIRED BY APPLICABLE LAW OR AGREED TO IN WRITING WILL ANY COPYRIGHT HOLDER, OR ANY OTHER PARTY WHO MAY MODIFY AND/OR REDISTRIBUTE THE PROGRAM AS PERMITTED ABOVE, BE LIABLE TO YOU FOR DAMAGES, INCLUDING ANY GENERAL, SPECIAL, INCIDENTAL OR CONSEQUENTIAL DAMAGES ARISING OUT OF THE USE OR INABILITY TO USE THE PROGRAM (INCLUDING BUT NOT LIMITED TO LOSS OF DATA OR DATA BEING RENDERED INACCURATE OR LOSSES SUSTAINED BY YOU OR THIRD PARTIES OR A FAILURE OF THE PROGRAM TO OPERATE WITH ANY OTHER PROGRAMS), EVEN IF SUCH HOLDER OR OTHER PARTY HAS BEEN ADVISED OF THE POSSIBILITY OF SUCH DAMAGES.

END OF TERMS AND CONDITIONS

GLOSSARY

ACL Access Control List. ACLs can limit network traffic and restrict access to certain users or devices by checking each packet for certain IP or MAC (i.e., Layer 2) information.

ARP Address Resolution Protocol converts between IP addresses and MAC (hardware) addresses. ARP is used to locate the MAC address corresponding to a given IP address. This allows the switch to use IP addresses for routing decisions and the corresponding MAC addresses to forward packets from one hop to the next.

BOOTP Boot Protocol is used to provide bootup information for network devices, including IP address information, the address of the TFTP server that contains the devices system files, and the name of the boot file.

CFM Connectivity Fault Management provides fault monitoring for end-to-end connections within a designated service area by using continuity check messages which can detect faults in maintenance points, fault verification through loop back messages, and fault isolation with link trace messages.

CoS Class of Service is supported by prioritizing packets based on the required level of service, and then placing them in the appropriate output queue. Data is transmitted from the queues using weighted round-robin service to enforce priority service and prevent blockage of lower-level queues. Priority may be set according to the port default, the packet's priority bit (in the VLAN tag), TCP/UDP port number, IP Precedence bit, or DSCP priority bit.

DHCP Dynamic Host Control Protocol. Provides a framework for passing configuration information to hosts on a TCP/IP network. DHCP is based on the Bootstrap Protocol (BOOTP), adding the capability of automatic allocation of reusable network addresses and additional configuration options.

DHCP SNOOPING A technique used to enhance network security by snooping on DHCP server messages to track the physical location of hosts, ensure that hosts only use the IP addresses assigned to them, and ensure that only authorized DHCP servers are accessible.

- DIFFSERV** Differentiated Services provides quality of service on large networks by employing a well-defined set of building blocks from which a variety of aggregate forwarding behaviors may be built. Each packet carries information (DS byte) used by each hop to give it a particular forwarding treatment, or per-hop behavior, at each network node. DiffServ allocates different levels of service to users on the network with mechanisms such as traffic meters, shapers/droppers, packet markers at the boundaries of the network.
- DNS** Domain Name Service. A system used for translating host names for network nodes into IP addresses.
- DSCP** Differentiated Services Code Point Service. DSCP uses a six-bit tag to provide for up to 64 different forwarding behaviors. Based on network policies, different kinds of traffic can be marked for different kinds of forwarding. The DSCP bits are mapped to the Class of Service categories, and then into the output queues.
- EAPOL** Extensible Authentication Protocol over LAN. EAPOL is a client authentication protocol used by this switch to verify the network access rights for any device that is plugged into the switch. A user name and password is requested by the switch, and then passed to an authentication server (e.g., RADIUS) for verification. EAPOL is implemented as part of the IEEE 802.1X Port Authentication standard.
- ERPS** Ethernet Ring Protection Switching can be used to increase the availability and robustness of Ethernet rings, such as those used in Metropolitan Area Networks (MAN). ERPS provides Layer 2 loop avoidance and fast re-convergence in Layer 2 ring topologies, supporting up to 255 nodes in the ring structure. It can also function with IEEE 802.1ag to support link monitoring when non-participating devices exist within the Ethernet ring.
- EUI** Extended Universal Identifier is an address format used by IPv6 to identify the host portion of the network address. The interface identifier in EUI compatible addresses is based on the link-layer (MAC) address of an interface. Interface identifiers used in global unicast and other IPv6 address types are 64 bits long and may be constructed in the EUI-64 format. The modified EUI-64 format interface ID is derived from a 48-bit link-layer address by inserting the hexadecimal number FFFE between the upper three bytes (OUI field) and the lower 3 bytes (serial number) of the link layer address. To ensure that the chosen address is from a unique Ethernet MAC address, the 7th bit in the high-order byte is set to 1 (equivalent to the IEEE Global/Local bit) to indicate the uniqueness of the 48-bit address.

- GARP** Generic Attribute Registration Protocol. GARP is a protocol that can be used by endstations and switches to register and propagate multicast group membership information in a switched environment so that multicast data frames are propagated only to those parts of a switched LAN containing registered endstations. Formerly called Group Address Registration Protocol.
- GMRP** Generic Multicast Registration Protocol. GMRP allows network devices to register end stations with multicast groups. GMRP requires that any participating network devices or end stations comply with the IEEE 802.1p standard.
- GVRP** GARP VLAN Registration Protocol. Defines a way for switches to exchange VLAN information in order to register necessary VLAN members on ports along the Spanning Tree so that VLANs defined in each switch can work automatically over a Spanning Tree network.
- ICMP** Internet Control Message Protocol is a network layer protocol that reports errors in processing IP packets. ICMP is also used by routers to feed back information about better routing choices.
- IEEE 802.1D** Specifies a general method for the operation of MAC bridges, including the Spanning Tree Protocol.
- IEEE 802.1Q** VLAN Tagging—Defines Ethernet frame tags which carry VLAN information. It allows switches to assign endstations to different virtual LANs, and defines a standard way for VLANs to communicate across switched networks.
- IEEE 802.1P** An IEEE standard for providing quality of service (QoS) in Ethernet networks. The standard uses packet tags that define up to eight traffic classes and allows switches to transmit packets based on the tagged priority value.
- IEEE 802.1s** An IEEE standard for the Multiple Spanning Tree Protocol (MSTP) which provides independent spanning trees for VLAN groups.
- IEEE 802.1w** An IEEE standard for the Rapid Spanning Tree Protocol (RSTP) which reduces the convergence time for network topology changes to about 10% of that required by the older IEEE 802.1D STP standard. (Now incorporated in IEEE 802.1D-2004)

IEEE 802.1X Port Authentication controls access to the switch ports by requiring users to first enter a user ID and password for authentication.

IEEE 802.3AC Defines frame extensions for VLAN tagging.

IEEE 802.3X Defines Ethernet frame start/stop requests and timers used for flow control on full-duplex links. (Now incorporated in IEEE 802.3-2002)

IGMP Internet Group Management Protocol. A protocol through which hosts can register with their local router for multicast services. If there is more than one multicast switch/router on a given subnetwork, one of the devices is made the "querier" and assumes responsibility for keeping track of group membership.

IGMP QUERY On each subnetwork, one IGMP-capable device will act as the querier — that is, the device that asks all hosts to report on the IP multicast groups they wish to join or to which they already belong. The elected querier will be the device with the lowest IP address in the subnetwork.

IGMP PROXY Proxies multicast group membership information onto the upstream interface based on IGMP messages monitored on downstream interfaces, and forwards multicast traffic based on that information. There is no need for multicast routing protocols in a simple tree that uses IGMP Proxy.

IGMP SNOOPING Listening to IGMP Query and IGMP Report packets transferred between IP Multicast Routers and IP Multicast host groups to identify IP Multicast group members.

IN-BAND MANAGEMENT Management of the network from a station attached directly to the network.

IP MULTICAST FILTERING A process whereby this switch can pass multicast traffic along to participating hosts.

IP PRECEDENCE The Type of Service (ToS) octet in the IPv4 header includes three precedence bits defining eight different priority levels ranging from highest priority for network control packets to lowest priority for routine traffic. The eight values are mapped one-to-one to the Class of Service categories by default, but may be configured differently to suit the requirements for specific network applications.

LACP Link Aggregation Control Protocol. Allows ports to automatically negotiate a trunked link with LACP-configured ports on another device.

LAYER 2 Data Link layer in the ISO 7-Layer Data Communications Protocol. This is related directly to the hardware interface for network devices and passes on traffic based on MAC addresses.

LINK AGGREGATION *See Port Trunk.*

LLDP Link Layer Discovery Protocol is used to discover basic information about neighboring devices in the local broadcast domain by using periodic broadcasts to advertise information such as device identification, capabilities and configuration settings.

MD5 MD5 Message-Digest is an algorithm that is used to create digital signatures. It is intended for use with 32 bit machines and is safer than the MD4 algorithm, which has been broken. MD5 is a one-way hash function, meaning that it takes a message and converts it into a fixed string of digits, also called a message digest.

MIB Management Information Base. An acronym for Management Information Base. It is a set of database objects that contains information about a specific device.

MSTP Multiple Spanning Tree Protocol can provide an independent spanning tree for different VLANs. It simplifies network management, provides for even faster convergence than RSTP by limiting the size of each region, and prevents VLAN members from being segmented from the rest of the group.

MRD Multicast Router Discovery is a A protocol used by IGMP snooping and multicast routing devices to discover which interfaces are attached to multicast routers. This process allows IGMP-enabled devices to determine where to send multicast source and group membership messages.

MULTICAST SWITCHING A process whereby the switch filters incoming multicast frames for services for which no attached host has registered, or forwards them to all ports contained within the designated multicast VLAN group.

MVR Multicast VLAN Registration is a method of using a single network-wide multicast VLAN to transmit common services, such as television channels or video-on-demand, across a service-provider's network. MVR simplifies the configuration of multicast services by using a common VLAN for distribution, while still preserving security and data isolation for subscribers residing in both the MVR VLAN and other standard or private VLAN groups.

NTP Network Time Protocol provides the mechanisms to synchronize time across the network. The time servers operate in a hierarchical-master-slave configuration in order to synchronize local clocks within the subnet and to national time standards via wire or radio.

OAM Operation, Administration, and Maintenance provides remote management tools required to monitor and maintain the links to subscriber CPEs (Customer Premise Equipment). This section describes functions including enabling OAM for selected ports, loopback testing, and displaying remote device information.

OUT-OF-BAND MANAGEMENT Management of the network from a station not attached to the network.

PORT AUTHENTICATION *See IEEE 802.1X.*

PORT MIRRORING A method whereby data on a target port is mirrored to a monitor port for troubleshooting with a logic analyzer or RMON probe. This allows data on the target port to be studied unobstructively.

PORT TRUNK Defines a network link aggregation and trunking method which specifies how to create a single high-speed logical link that combines several lower-speed physical links.

QINQ QinQ tunneling is designed for service providers carrying traffic for multiple customers across their networks. It is used to maintain customer-specific VLAN and Layer 2 protocol configurations even when different customers use the same internal VLAN IDs.

QoS Quality of Service. QoS refers to the capability of a network to provide better service to selected traffic flows using features such as data prioritization, queuing, congestion avoidance and traffic shaping. These features effectively provide preferential treatment to specific flows either by raising the priority of one flow or limiting the priority of another flow.

- RADIUS** Remote Authentication Dial-in User Service. RADIUS is a logon authentication protocol that uses software running on a central server to control access to RADIUS-compliant devices on the network.
- RMON** Remote Monitoring. RMON provides comprehensive network monitoring capabilities. It eliminates the polling required in standard SNMP, and can set alarms on a variety of traffic conditions, including specific error types.
- RSTP** Rapid Spanning Tree Protocol. RSTP reduces the convergence time for network topology changes to about 10% of that required by the older IEEE 802.1D STP standard.
- SMTP** Simple Mail Transfer Protocol is a standard host-to-host mail transport protocol that operates over TCP, port 25.
- SNMP** Simple Network Management Protocol. The application protocol in the Internet suite of protocols which offers network management services.
- SNTP** Simple Network Time Protocol allows a device to set its internal clock based on periodic updates from a Network Time Protocol (NTP) server. Updates can be requested from a specific NTP server, or can be received via broadcasts sent by NTP servers.
- SSH** Secure Shell is a secure replacement for remote access functions, including Telnet. SSH can authenticate users with a cryptographic key, and encrypt data connections between management clients and the switch.
- STA** Spanning Tree Algorithm is a technology that checks your network for any loops. A loop can often occur in complicated or backup linked network systems. Spanning Tree detects and directs data along the shortest available path, maximizing the performance and efficiency of the network.
- TACACS+** Terminal Access Controller Access Control System Plus. TACACS+ is a logon authentication protocol that uses software running on a central server to control access to TACACS-compliant devices on the network.
- TCP/IP** Transmission Control Protocol/Internet Protocol. Protocol suite that includes TCP as the primary transport protocol, and IP as the network layer protocol.
- TELNET** Defines a remote communication facility for interfacing to a terminal device over TCP/IP.

- TFTP** Trivial File Transfer Protocol. A TCP/IP protocol commonly used for software downloads.
- UDP** User Datagram Protocol. UDP provides a datagram mode for packet-switched communications. It uses IP as the underlying transport mechanism to provide access to IP-like services. UDP packets are delivered just like IP packets – connection-less datagrams that may be discarded before reaching their targets. UDP is useful when TCP would be too complex, too slow, or just unnecessary.
- UTC** Universal Time Coordinate. UTC is a time scale that couples Greenwich Mean Time (based solely on the Earth’s rotation rate) with highly accurate atomic time. The UTC does not have daylight saving time.
- VLAN** Virtual LAN. A Virtual LAN is a collection of network nodes that share the same collision domain regardless of their physical location or connection point in the network. A VLAN serves as a logical workgroup with no physical barriers, and allows users to share information and resources as though located on the same LAN.
- XMODEM** A protocol used to transfer files between devices. Data is grouped in 128-byte blocks and error-corrected.

COMMAND LIST

A

aaa accounting commands 838
aaa accounting dot1x 839
aaa accounting exec 840
aaa accounting update 841
aaa authorization exec 842
aaa group server 843
absolute 783
access-list arp 989
access-list ip 970
access-list ipv6 977
access-list mac 983
accounting commands 844
accounting dot1x 844
accounting exec 845
alias 997
arp 1429
authentication enable 828
authentication login 829
authorization exec 845
auto-traffic-control 1063
auto-traffic-control action 1063
auto-traffic-control alarm-clear-
threshold 1064
auto-traffic-control alarm-fire-threshold
1065
auto-traffic-control apply-timer 1061
auto-traffic-control auto-control-release
1066
auto-traffic-control control-release
1067
auto-traffic-control release-timer 1062

B

banner configure 719
banner configure company 720
banner configure dc-power-info 721
banner configure department 721
banner configure equipment-info 722
banner configure equipment-location
723
banner configure ip-lan 723
banner configure ip-number 724
banner configure manager-info 725
banner configure mux 725
banner configure note 726
boot system 737
bridge-ext gvrp 1150

C

calendar set 781
capabilities 997
channel-group 1024
class 1212
class-map 1208
clear access-list hardware counters
992
clear arp-cache 1430
clear counters 1004
clear dns cache 1406
clear efm oam counters 1394
clear efm oam event-log 1394
clear erps statistics 1140
clear ethernet cfm ais mpid 1359
clear ethernet cfm errors 1371
clear ethernet cfm linktrace-cache
1380
clear ethernet cfm maintenance-points
remote 1370
clear host 1407
clear ip dhcp snooping binding 924
clear ip dhcp snooping database flash
924
clear ip igmp snooping groups dynamic
1242
clear ip igmp snooping statistics 1243
clear ip source-guard binding blocked
941
clear ipv6 dhcp snooping binding 933
clear ipv6 dhcp snooping database flash
934
clear ipv6 mld snooping groups dynamic
1269
clear ipv6 mld snooping statistics 1270
clear ipv6 nd snooping binding 1464
clear ipv6 nd snooping prefix 1465
clear ipv6 neighbors 1456
clear ipv6 traffic 1449
clear log 763
clear mac-address-table dynamic 1087
clear mrv groups dynamic 1293
clear mrv statistics 1293
clear mvr6 groups dynamic 1314
clear mvr6 statistics 1315
clear network-access 906
clear pppoe intermediate-agent
statistics 885
clock summer-time (date) 777
clock summer-time (predefined) 778

clock summer-time (recurring) 779
 clock timezone 780
 cluster 787
 cluster commander 787
 cluster ip-pool 788
 cluster member 789
 configure 713
 control-vlan 1122
 copy 738

D

databits 749
 delete 741
 delete public-key 858
 description 1209
 description 998
 dir 742
 disable 714
 discard 999
 disconnect 756
 dos-protection echo-charge 958
 dos-protection smurf 958
 dos-protection tcp-flooding 959
 dos-protection tcp-null-scan 959
 dos-protection tcp-syn-fin-scan 960
 dos-protection tcp-udp-port-zero 960
 dos-protection tcp-xmas-scan 961
 dos-protection udp-flooding 961
 dos-protection win-nuke 962
 dot1q-tunnel system-tunnel-control
 1166
 dot1x default 863
 dot1x eapol-pass-through 864
 dot1x identity profile 872
 dot1x intrusion-action 865
 dot1x max-reauth-req 866
 dot1x max-req 866
 dot1x max-start 872
 dot1x operation-mode 867
 dot1x pae supplicant 873
 dot1x port-control 868
 dot1x re-authenticate 871
 dot1x re-authentication 868
 dot1x system-auth-control 865
 dot1x timeout auth-period 874
 dot1x timeout held-period 874
 dot1x timeout quiet-period 869
 dot1x timeout re-authperiod 869
 dot1x timeout start-period 875
 dot1x timeout supp-timeout 870
 dot1x timeout tx-period 870

E

efm oam 1390
 efm oam critical-link-event 1390
 efm oam link-monitor frame 1391

efm oam link-monitor frame threshold
 1392
 efm oam link-monitor frame window
 1392
 efm oam mode 1393
 efm oam remote-loopback 1395
 efm oam remote-loopback test 1396
 enable 1123
 enable 711
 enable password 824
 end 715
 erps 1121
 erps clear 1140
 erps domain 1121
 erps forced-switch 1141
 erps manual-switch 1143
 ethernet cfm ais level 1350
 ethernet cfm ais ma 1351
 ethernet cfm ais period 1352
 ethernet cfm ais suppress alarm 1352
 ethernet cfm cc enable 1368
 ethernet cfm cc ma interval 1367
 ethernet cfm delay-measure two-way
 1386
 ethernet cfm domain 1353
 ethernet cfm enable 1355
 ethernet cfm linktrace 1379
 ethernet cfm linktrace cache 1376
 ethernet cfm linktrace cache hold-time
 1377
 ethernet cfm linktrace cache size 1378
 ethernet cfm loopback 1381
 ethernet cfm mep 1358
 ethernet cfm mep crosscheck 1375
 ethernet cfm mep crosscheck
 start-delay 1373
 ethernet cfm port-enable 1359
 exec-timeout 750
 exit 715

F

flowcontrol 1000

G

garp timer 1151
 guard-timer 1124

H

holdoff-timer 1124
 hostname 718

I

interface 996
 interface vlan 1157

ip access-group 975
 ip address 1422
 ip arp inspection 949
 ip arp inspection filter 950
 ip arp inspection limit 954
 ip arp inspection log-buffer logs 951
 ip arp inspection trust 954
 ip arp inspection validate 952
 ip arp inspection vlan 953
 ip default-gateway 1424
 ip dhcp client class-id 1412
 ip dhcp relay server 1417
 ip dhcp restart client 1413
 ip dhcp restart relay 1418
 ip dhcp snooping 916
 ip dhcp snooping database flash 925
 ip dhcp snooping information option 918
 ip dhcp snooping information option circuit-id 922
 ip dhcp snooping information policy 919
 ip dhcp snooping limit rate 920
 ip dhcp snooping trust 923
 ip dhcp snooping verify mac-address 920
 ip dhcp snooping vlan 921
 ip domain-list 1401
 ip domain-lookup 1402
 ip domain-name 1403
 ip host 1404
 ip http port 847
 ip http secure-port 848
 ip http secure-server 849
 ip http server 848
 ip igmp authentication 1253
 ip igmp filter (Global Configuration) 1251
 ip igmp filter (Interface Configuration) 1255
 ip igmp max-groups 1255
 ip igmp max-groups action 1256
 ip igmp profile 1251
 ip igmp query-drop 1257
 ip igmp snooping 1227
 ip igmp snooping priority 1228
 ip igmp snooping proxy-reporting 1228
 ip igmp snooping querier 1229
 ip igmp snooping router-alert-option-check 1229
 ip igmp snooping router-port-expire-time 1230
 ip igmp snooping tcn-flood 1231
 ip igmp snooping tcn-query-solicit 1232
 ip igmp snooping unregistered-data-flood 1232
 ip igmp snooping unsolicited-report-interval 1233
 ip igmp snooping version 1234
 ip igmp snooping version-exclusive 1234
 ip igmp snooping vlan general-query-suppression 1235
 ip igmp snooping vlan last-memb-query-count 1237
 ip igmp snooping vlan last-memb-query-intvl 1237
 ip igmp snooping vlan mrd 1238
 ip igmp snooping vlan mrouter 1249
 ip igmp snooping vlan proxy-address 1239
 ip igmp snooping vlan query-interval 1240
 ip igmp snooping vlan static 1242
 ip igmp snooping vlan immediate-leave 1236
 ip igmp snooping vlan query-resp-intvl 1241
 ip multicast-data-drop 1257
 ip name-server 1405
 ip proxy-arp 1430
 ip route 1468
 ip source-guard 938
 ip source-guard binding 936
 ip source-guard max-binding 939
 ip source-guard mode 940
 ip ssh authentication-retries 856
 ip ssh crypto host-key generate 858
 ip ssh crypto zeroize 859
 ip ssh save host-key 860
 ip ssh server 856
 ip ssh server-key size 857
 ip ssh timeout 857
 ip sw-route 1469
 ip telnet max-sessions 851
 ip telnet port 851
 ip telnet server 852
 ip tftp retry 746
 ip tftp timeout 747
 ipv6 access-group 981
 ipv6 address 1434
 ipv6 address autoconfig 1435
 ipv6 address eui-64 1436
 ipv6 address link-local 1438
 ipv6 default-gateway 1433
 ipv6 dhcp client rapid-commit vlan 1414
 ipv6 dhcp restart client vlan 1415
 ipv6 dhcp snooping 927
 ipv6 dhcp snooping max-binding 932
 ipv6 dhcp snooping option remote-id 929
 ipv6 dhcp snooping option remote-id policy 930
 ipv6 dhcp snooping trust 932
 ipv6 dhcp snooping vlan 931
 ipv6 enable 1439

- ipv6 host 1406
 - ipv6 mld filter (Global Configuration) 1273
 - ipv6 mld filter (Interface Configuration) 1275
 - ipv6 mld max-groups 1276
 - ipv6 mld max-groups action 1277
 - ipv6 mld profile 1274
 - ipv6 mld query-drop 1277
 - ipv6 mld snooping 1263
 - ipv6 mld snooping querier 1263
 - ipv6 mld snooping query-interval 1264
 - ipv6 mld snooping query-max-response-time 1265
 - ipv6 mld snooping robustness 1265
 - ipv6 mld snooping router-port-expire-time 1266
 - ipv6 mld snooping unknown-multicast mode 1266
 - ipv6 mld snooping version 1267
 - ipv6 mld snooping vlan immediate-leave 1267
 - ipv6 mld snooping vlan mrouter 1268
 - ipv6 mld snooping vlan static 1269
 - ipv6 mtu 1441
 - ipv6 multicast-data-drop 1278
 - ipv6 nd dad attempts 1452
 - ipv6 nd ns-interval 1453
 - ipv6 nd rguard 1454
 - ipv6 nd reachable-time 1455
 - ipv6 nd snooping 1459
 - ipv6 nd snooping auto-detect 1461
 - ipv6 nd snooping auto-detect retransmit count 1461
 - ipv6 nd snooping auto-detect retransmit interval 1462
 - ipv6 nd snooping max-binding 1463
 - ipv6 nd snooping prefix timeout 1463
 - ipv6 nd snooping trust 1464
 - ipv6 source-guard 945
 - ipv6 source-guard binding 943
 - ipv6 source-guard max-binding 946
- J**
- jumbo frame 735
- L**
- l2protocol-tunnel tunnel-dmac 1172
 - lACP 1024
 - lACP admin-key (Ethernet Interface) 1026
 - lACP admin-key (Port Channel) 1028
 - lACP port-priority 1027
 - lACP system-priority 1028
 - lACP timeout 1029
 - line 749
- lldp 1325
 - lldp admin-status 1329
 - lldp basic-tlv management-ip-address 1329
 - lldp basic-tlv port-description 1330
 - lldp basic-tlv system-capabilities 1331
 - lldp basic-tlv system-description 1331
 - lldp basic-tlv system-name 1332
 - lldp dot1-tlv proto-ident 1332
 - lldp dot1-tlv proto-vid 1333
 - lldp dot1-tlv pvid 1333
 - lldp dot1-tlv vlan-name 1334
 - lldp dot3-tlv link-aggr 1334
 - lldp dot3-tlv mac-phy 1335
 - lldp dot3-tlv max-frame 1335
 - lldp dot3-tlv poe 1336
 - lldp holdtime-multiplier 1325
 - lldp med-fast-start-count 1326
 - lldp med-location civic-addr 1336
 - lldp med-notification 1338
 - lldp med-tlv ext-poe 1339
 - lldp med-tlv inventory 1339
 - lldp med-tlv location 1340
 - lldp med-tlv med-cap 1340
 - lldp med-tlv network-policy 1341
 - lldp notification 1341
 - lldp notification-interval 1326
 - lldp refresh-interval 1327
 - lldp reinit-delay 1327
 - lldp tx-delay 1328
 - logging facility 759
 - logging history 760
 - logging host 761
 - logging on 761
 - logging sendmail 766
 - logging sendmail destination-email 768
 - logging sendmail host 766
 - logging sendmail level 767
 - logging sendmail source-email 768
 - logging trap 762
 - login 751
 - loopback detection trap 1076
 - loopback-detection 1074
 - loopback-detection action 1074
 - loopback-detection recover-time 1075
 - loopback-detection release 1077
 - loopback-detection transmit-interval 1076
- M**
- ma index name 1356
 - ma index name-format 1357
 - mac access-group 987
 - mac-address-table aging-time 1085
 - mac-address-table static 1086
 - mac-authentication intrusion-action 905

mac-authentication max-mac-count 906
 mac-authentication reauth-time 898
 mac-learning 890
 mac-vlan 1185
 major-domain 1125
 management 878
 match 1210
 max-hops 1100
 media-type 1001
 meg-level 1126
 memory 813
 mep archive-hold-time 1370
 mep crosscheck mpid 1374
 mep fault-notify alarm-time 1382
 mep fault-notify lowest-priority 1383
 mep fault-notify reset-time 1385
 mep-monitor 1126
 mst priority 1100
 mst vlan 1101
 mvr 1282
 mvr associated-profile 1283
 mvr domain 1283
 mvr immediate-leave 1290
 mvr priority 1284
 mvr profile 1284
 mvr proxy-query-interval 1285
 mvr proxy-switching 1286
 mvr robustness-value 1287
 mvr source-port-mode dynamic 1288
 mvr type 1291
 mvr upstream-source-ip 1288
 mvr vlan 1289
 mvr vlan group 1292
 mvr6 associated-profile 1304
 mvr6 domain 1305
 mvr6 immediate-leave 1311
 mvr6 priority 1305
 mvr6 profile 1306
 mvr6 proxy-query-interval 1307
 mvr6 proxy-switching 1307
 mvr6 robustness-value 1309
 mvr6 source-port-mode dynamic 1309
 mvr6 type 1312
 mvr6 upstream-source-ip 1310
 mvr6 vlan 1311
 mvr6 vlan group 1313

N

name 1102
 negotiation 1001
 network-access aging 896
 network-access dynamic-qos 898
 network-access dynamic-vlan 899
 network-access guest-vlan 900
 network-access link-detection 901
 network-access link-detection link-down 901

network-access link-detection link-up 902
 network-access link-detection link-up-down 902
 network-access mac-filter 897
 network-access max-mac-count 903
 network-access mode mac-authentication 904
 network-access port-mac-filter 905
 nlm 810
 no rspan session 1053
 node-id 1127
 non-erps-dev-protect 1128
 non-revertive 1129
 ntp authenticate 773
 ntp authentication-key 774
 ntp client 774
 ntp server 775

P

parity 752
 password 752
 password-thresh 753
 periodic 784
 permit, deny 1252
 permit, deny 1274
 permit, deny (ARP ACL) 990
 permit, deny (Extended IPv6 ACL) 979
 permit, deny (Extended IPv4 ACL) 972
 permit, deny (MAC ACL) 984
 permit, deny (Standard IPv6 ACL) 978
 permit, deny (Standard IP ACL) 971
 ping 1427
 ping6 1449
 police flow 1213
 police srtcm-color 1215
 police trtcm-color 1217
 policy-map 1211
 port channel load-balance 1022
 port monitor 1045
 port security 891
 port security mac-address-as-permanent 893
 power inline 1037
 power inline compatible 1035
 power inline maximum allocation 1038
 power inline priority 1039
 power inline time-range 1040
 power mainpower maximum allocation 1036
 power-save 1019
 pppoe intermediate-agent 881
 pppoe intermediate-agent format-type 881
 pppoe intermediate-agent port-enable 882
 pppoe intermediate-agent port-format-type 883

pppoe intermediate-agent trust 884
 pppoe intermediate-agent vendor-tag
 strip 884
 privilege 827
 process cpu 814
 prompt 709
 propagate-tc 1133
 protocol-vlan protocol-group
 (Configuring Groups) 1179
 protocol-vlan protocol-group
 (Configuring Interfaces) 1180

Q

qos map cos-dscp 1200
 qos map dscp-mutation 1202
 qos map phb-queue 1203
 qos map trust-mode 1204
 queue mode 1196
 queue weight 1197
 quit 712

R

radius-server acct-port 830
 radius-server auth-port 831
 radius-server host 831
 radius-server key 832
 radius-server retransmit 833
 radius-server timeout 833
 range 1252
 range 1275
 raps-def-mac 1134
 raps-without-vc 1134
 rate-limit 1056
 rcommand 789
 reload (Global Configuration) 710
 reload (Privileged Exec) 714
 rename 1211
 revision 1102
 ring-port 1136
 rmon alarm 816
 rmon collection history 818
 rmon collection rmon1 819
 rmon event 817
 rpl neighbor 1137
 rpl owner 1138
 rspan destination 1051
 rspan remote vlan 1052
 rspan source 1050

S

server 843
 service-policy 1222
 set cos 1219
 set ip dscp 1220
 set phb 1221

show access-group 992
 show access-list 993
 show access-list arp 991
 show access-list tcam-utilization 728
 show accounting 846
 show arp 1431
 show auto-traffic-control 1071
 show auto-traffic-control interface
 1072
 show banner 727
 show bridge-ext 1153
 show cable-diagnostics 1018
 show calendar 782
 show class-map 1223
 show cluster 790
 show cluster candidates 791
 show cluster members 790
 show discard 1004
 show dns 1407
 show dns cache 1408
 show dos-protection 962
 show dot1q-tunnel 1171
 show dot1x 875
 show efm oam counters interface
 1397
 show efm oam event-log interface
 1397
 show efm oam remote-loopback
 interface 1399
 show efm oam status interface 1399
 show efm oam status remote interface
 1400
 show erps 1145
 show ethernet cfm configuration 1360
 show ethernet cfm errors 1372
 show ethernet cfm fault-notify-
 generator 1385
 show ethernet cfm linktrace-cache
 1380
 show ethernet cfm ma 1362
 show ethernet cfm maintenance-points
 local 1363
 show ethernet cfm maintenance-points
 local detail mep 1364
 show ethernet cfm maintenance-points
 remote crosscheck 1376
 show ethernet cfm maintenance-points
 remote detail 1365
 show ethernet cfm md 1362
 show garp timer 1153
 show gvrp configuration 1154
 show history 712
 show hosts 1408
 show interfaces brief 1005
 show interfaces counters 1005
 show interfaces protocol-vlan
 protocol-group 1181
 show interfaces status 1007
 show interfaces switchport 1008

show interfaces transceiver 1015
 show interfaces transceiver-threshold 1016
 show ip access-group 975
 show ip access-list 976
 show ip arp inspection configuration 955
 show ip arp inspection interface 955
 show ip arp inspection log 956
 show ip arp inspection statistics 956
 show ip arp inspection vlan 956
 show ip dhcp snooping 925
 show ip dhcp snooping binding 926
 show ip igmp authentication 1258
 show ip igmp filter 1258
 show ip igmp profile 1259
 show ip igmp query-drop 1260
 show ip igmp snooping 1243
 show ip igmp snooping group 1244
 show ip igmp snooping mrouter 1245
 show ip igmp snooping statistics 1246
 show ip igmp throttle interface 1260
 show ip interface 1425
 show ip multicast-data-drop 1261
 show ip route 1469
 show ip route database 1470
 show ip route summary 1471
 show ip source-guard 941
 show ip source-guard binding 942
 show ip ssh 860
 show ip telnet 852
 show ip tftp 747
 show ip traffic 1425
 show ipv6 access-group 981
 show ipv6 access-list 982
 show ipv6 default-gateway 1442
 show ipv6 dhcp duid 1416
 show ipv6 dhcp snooping 934
 show ipv6 dhcp snooping binding 935
 show ipv6 dhcp snooping statistics 935
 show ipv6 dhcp vlan 1417
 show ipv6 interface 1442
 show ipv6 mld filter 1278
 show ipv6 mld profile 1279
 show ipv6 mld query-drop 1280
 show ipv6 mld snooping 1270
 show ipv6 mld snooping group 1271
 show ipv6 mld snooping group source-list 1271
 show ipv6 mld snooping mrouter 1272
 show ipv6 mld throttle interface 1280
 show ipv6 mtu 1444
 show ipv6 nd rguard 1456
 show ipv6 nd snooping 1465
 show ipv6 nd snooping binding 1466
 show ipv6 nd snooping prefix 1466
 show ipv6 neighbors 1457
 show ipv6 source-guard 947
 show ipv6 source-guard binding 948
 show ipv6 traffic 1445
 show l2protocol-tunnel 1175
 show lacp 1030
 show line 758
 show lldp config 1342
 show lldp info local-device 1343
 show lldp info remote-device 1344
 show lldp info statistics 1346
 show log 763
 show logging 764
 show logging sendmail 769
 show loopback-detection 1077
 show mac access-group 988
 show mac access-list 988
 show mac-address-table 1087
 show mac-address-table aging-time 1088
 show mac-address-table count 1089
 show mac-vlan 1186
 show management 879
 show memory 728
 show mvr 1293
 show mvr associated-profile 1295
 show mvr interface 1295
 show mvr members 1296
 show mvr profile 1298
 show mvr statistics 1298
 show mvr6 1315
 show mvr6 associated-profile 1316
 show mvr6 interface 1317
 show mvr6 members 1318
 show mvr6 profile 1319
 show mvr6 statistics 1320
 show network-access 907
 show network-access mac-address-table 908
 show network-access mac-filter 909
 show nlm oper-status 812
 show ntp 776
 show policy-map 1223
 show policy-map interface 1224
 show port monitor 1047
 show port security 893
 show port-channel load-balance 1033
 show power inline status 1041
 show power inline time-range 1042
 show power mainpower 1042
 show power-save 1020
 show pppoe intermediate-agent info 885
 show pppoe intermediate-agent statistics 886
 show privilege 827
 show process cpu 729
 show protocol-vlan protocol-group 1181
 show public-key 861
 show qos map cos-dscp 1205
 show qos map dscp-mutation 1205

speed 754
 speed-duplex 1002
 stopbits 755
 subnet-vlan 1183
 switchport acceptable-frame-types 1158
 switchport allowed vlan 1159
 switchport dot1q-tunnel mode 1167
 switchport dot1q-tunnel service match cvid 1168
 switchport dot1q-tunnel tpid 1170
 switchport forbidden vlan 1152
 switchport gvrp 1152
 switchport ingress-filtering 1160
 switchport l2protocol-tunnel 1175
 switchport mode 1161
 switchport native vlan 1161
 switchport packet-rate 1057
 switchport priority default 1198
 switchport vlan-translation 1176
 switchport voice vlan priority 1190
 switchport voice vlan rule 1191
 switchport voice vlan security 1192
 switchport voice vlan 1190

T

tacacs-server host 835
 tacacs-server key 835
 tacacs-server port 836
 tacacs-server retransmit 836
 tacacs-server timeout 837
 terminal 757
 test cable-diagnostics 1017
 timeout login response 756
 time-range 783
 traceroute 1426
 traceroute6 1450
 traffic-segmentation 963
 traffic-segmentation session 964
 traffic-segmentation uplink/downlink 965

traffic-segmentation uplink-to-uplink 966
 transceiver-monitor 1009
 transceiver-threshold current 1010
 transceiver-threshold rx-power 1011
 transceiver-threshold temperature 1012
 transceiver-threshold tx-power 1013
 transceiver-threshold voltage 1014
 transceiver-threshold-auto 1010

U

udd aggressive 1080
 udd message-interval 1079
 udd port 1081
 upgrade opcode auto 743
 upgrade opcode path 744
 upgrade opcode reload 745
 username 825

V

version 1138
 vlan 1156
 vlan database 1155
 vlan-trunking 1162
 voice vlan 1187
 voice vlan aging 1188
 voice vlan mac-address 1189

W

watchdog software 735
 web-auth 912
 web-auth login-attempts 910
 web-auth quiet-period 911
 web-auth re-authenticate (IP) 913
 web-auth re-authenticate (Port) 913
 web-auth session-timeout 911
 web-auth system-auth-control 912
 whichboot 743
 wtr-timer 1139

INDEX

NUMERICS

- 802.1Q tunnel 212, 1165
 - access 219, 1167
 - configuration, guidelines 215, 1165
 - configuration, limitations 215, 1166
 - CVID to SVID map 217, 1168
 - description 212
 - ethernet type 216, 1170
 - interface configuration 219, 1167–1170
 - mode selection 219, 1167
 - status, configuring 216, 1166
 - TPID 216, 1170
 - uplink 219, 1167
- 802.1X
 - authenticator, configuring 390, 865–871
 - global settings 389, 863–865
 - port authentication 387, 862, 865
 - port authentication accounting 318, 844
 - supplicant, configuring 394, 872–875

A

- AAA
 - accounting 802.1X port settings 318, 844
 - accounting exec command privileges 318, 319, 323, 840, 844
 - accounting exec settings 318, 323, 845
 - accounting summary 319, 846
 - accounting update 318, 841
 - accounting, configuring 317, 838
 - authorization & accounting 310, 838
 - authorization exec settings 842, 845
 - authorization method 324, 845
 - authorization settings 323, 842
 - authorization summary 325, 846
 - RADIUS group settings 318, 843
 - TACACS+ group settings 318, 843
- acceptable frame type 206, 1158
- Access Control List *See* ACL
- ACL 352, 969
 - ARP 358, 369, 989
 - binding to a port 371, 975
 - IPv4 Extended 357, 360, 969, 972
 - IPv4 Standard 357, 359, 969, 971
 - IPv6 Extended 357, 365, 976, 979
 - IPv6 Standard 357, 363, 976, 978
 - MAC 358, 367, 983
 - time range 353, 782
- Address Resolution Protocol *See* ARP

- address table 231, 1085
 - aging time 234, 1085
 - aging time, displaying 234, 1088
 - aging time, setting 234, 1085
- administrative users, displaying 733
- ARP
 - ACL 369, 378, 950
 - configuration 686, 1429
 - description 686
 - proxy 686, 1430
 - statistics 690
- ARP inspection 375, 948
 - ACL filter 378, 950
 - additional validation criteria 377, 952
 - ARP ACL 379, 989
 - enabling globally 377, 949
 - enabling per VLAN 379, 953
 - trusted ports 380, 954
- ATC 266, 1058
 - control response 269, 1063
 - functional limitations 267, 1061
 - limiting traffic rates 266, 1060
 - shutting down a port 267, 1061
 - thresholds 269, 1064, 1065
 - timers 268, 1061, 1062
 - usage 266, 1060
- authentication
 - MAC address authentication 331, 895, 904
 - MAC, configuring ports 334, 895
 - network access 331, 895, 904
 - public key, SSH 346, 855
 - web 328, 912
 - web authentication port information, displaying 330, 914
 - web authentication, configuring ports 330, 912
 - web authentication, re-authenticating address 330, 913
 - web authentication, re-authenticating ports 330, 913
 - web, configuring 329, 912
- Automatic Traffic Control *See* ATC

B

- BOOTP 640, 1422
- BPDU 240
 - filter 253, 1103
 - flooding when STA disabled on VLAN 245, 1112
 - flooding when STA globally disabled 245, 1099
 - guard 253, 1104

- ignoring superior BPDUs 252, 1113
- selecting protocol based on message format 253, 1115
- shut down port on receipt 253, 1104

bridge extension capabilities, displaying 127, 1153

broadcast storm, threshold 263, 264, 1057

C

cable diagnostics 174, 1017

canonical format indicator 283

CDP, discard 999

CFM

- basic operations 522
- continuity check errors 555, 1371, 1372
- continuity check messages 510, 520, 522, 523, 1128, 1347, 1367, 1368
- cross-check errors 1369, 1373, 1375
- cross-check message 520, 523, 1347, 1373, 1375, 1376
- cross-check start delay 524, 1373
- delay measure 544, 1386
- description 520
- domain service access point 520, 532, 537, 1354
- fault isolation 520, 1347, 1379
- fault notification 520, 554, 1347, 1382, 1383, 1385
- fault notification generator 523, 529, 554, 1383, 1385
- fault verification 520, 1347
- link trace cache 552, 1377, 1378, 1380
- link trace message 520, 522, 540, 1347, 1376, 1377, 1379
- loop back messages 520, 522, 542, 1347, 1381
- maintenance association 520, 532, 1347, 1356, 1362
- maintenance domain 520, 521, 527, 1347, 1353, 1362
- maintenance end point 521, 523, 528, 533, 537, 546, 547, 1355, 1358, 1363
- maintenance intermediate point 521, 528, 548, 1353, 1354, 1356, 1363
- maintenance level 521, 522, 1353
- maintenance point 520, 1347, 1363
- MEP archive 530, 1370
- MEP direction 537, 1358
- remote maintenance end point 523, 532, 538, 547, 549, 550, 1364, 1365, 1370, 1374
- service instance 520, 522, 1356
- SNMP traps 525, 1369, 1373

class map

- description 1209
- DiffServ 288, 1208

Class of Service *See* CoS

CLI

- command modes 702
- showing commands 700

clustering switches, management access 490, 787

command line interface *See* CLI

committed burst size, QoS policy 295, 296, 297, 1213, 1215, 1217

committed information rate, QoS policy 295, 296, 297, 1213, 1215, 1217

community string 97, 466, 795

configuration file, DHCP download reference 95

configuration files, restoring defaults 129, 736

configuration settings

- restoring 99, 131, 132, 736, 738
- saving 99, 131, 736, 738

Connectivity Fault Management *See* CFM

console port, required connections 86

continuity check errors, CFM 555, 1371, 1372

continuity check messages, CFM 510, 520, 522, 523, 1128, 1347, 1367, 1368

CoS 273, 1204

- configuring 273, 1195
- default mapping to internal values 283, 1201
- enabling 280, 1204
- layer 3/4 priorities 279, 1200
- priorities, mapping to internal values 283, 1200
- queue mapping 277, 1203
- queue mode 274, 1196
- queue weights, assigning 275, 1197

CoS/CFI to PHB/drop precedence 283, 1200

CPU

- status 148, 729
- utilization, setting trap 814
- utilization, showing 148, 729

cross-check errors, CFM 1369, 1373, 1375

cross-check message, CFM 520, 523, 1347, 1373, 1375, 1376

cross-check start delay, CFM 524, 1373

CVLAN to SPVLAN map 217, 1168

D

default IPv4 gateway, configuration 1424

default IPv6 gateway, configuration 644, 1433

default priority, ingress port 273, 1198

default settings, system 82

delay measure, CFM 544, 1386

DHCPv4 640, 669, 1422

- class identifier 670, 1412
- client 640, 1411, 1422
- client identifier 669, 670, 1412
- dynamic configuration 92
- relay server 671, 1417
- relay service, enabling 672, 1418

DHCPv4 snooping 412, 915

- enabling 415, 916
- global configuration 415, 916
- information option 415, 918
- information option policy 415, 919
- information option, enabling 415, 918
- option 82 information, circuit-id 418, 922
- policy selection 415, 919
- specifying trusted interfaces 417, 923
- verifying MAC addresses 415, 920

- VLAN configuration 417, 921
 - DHCPv6 snooping 926
 - enabling 927
 - global configuration 927
 - remote ID 929
 - remote ID policy 930
 - specifying trusted interfaces 932
 - VLAN configuration 931
 - Differentiated Code Point Service *See* DSCP
 - Differentiated Services *See* DiffServ
 - DiffServ 287, 1207
 - binding policy to interface 301, 1222
 - class map 288, 1208, 1212
 - class map, description 1209
 - classifying QoS traffic 288, 1210
 - color aware, srTCM 296, 1215
 - color aware, trTCM 297, 1217
 - color blind, srTCM 296, 1215
 - color blind, trTCM 297, 1217
 - committed burst size 295, 296, 297, 1213, 1215, 1217
 - committed information rate 295, 296, 297, 1213, 1215, 1217
 - configuring 287, 1207
 - conforming traffic, configuring response 295, 1213, 1215, 1217
 - description 1209
 - excess burst size 296, 1215
 - metering, configuring 291, 292, 293, 1213
 - peak burst size 297, 1217
 - peak information rate 297, 1217
 - policy map 291, 1211
 - policy map, description 289, 294, 1209
 - QoS policy 291, 1211
 - service policy 301, 1222
 - setting CoS for matching packets 295, 1219
 - setting IP DSCP for matching packets 295, 1220
 - setting PHB for matching packets 295, 1221
 - single-rate, three-color meter 292, 296, 1215
 - srTCM metering 292, 296, 1215
 - traffic between CIR and BE, configuring response 296, 1215
 - traffic between CIR and PIR, configuring response 297, 1217
 - trTCM metering 297, 1217
 - two-rate, three-color meter 293, 1217
 - violating traffic, configuring response 298, 1213, 1215, 1217
 - DNS
 - default domain name 663, 1403
 - displaying the cache 668, 1408
 - domain name list 663, 1404
 - enabling lookup 663, 1402
 - name server list 663, 1405
 - static entries, IPv4 667, 1404
 - static entries, IPv6 1406
 - Domain Name Service *See* DNS
 - domain service access point, CFM 520, 532, 537, 1354
 - DoS protection 399, 957
 - downloading software 129, 738
 - automatically 133, 743
 - using FTP or TFTP 133, 738
 - drop precedence
 - CoS priority mapping 284, 1200
 - DSCP ingress map 282, 1202
 - DSA encryption 348, 350, 858
 - DSCP 279, 1204
 - enabling 280, 1204
 - mapping to internal values 281, 1202
 - DSCP ingress map, drop precedence 282, 1202
 - DSCP to PHB/drop precedence 282, 1202
 - dynamic addresses
 - clearing 236, 1087
 - displaying 235, 1087
 - Dynamic Host Configuration Protocol *See* DHCPv4
 - dynamic QoS assignment 332, 335, 898
 - dynamic VLAN assignment 331, 335, 899
- ## E
- edge port, STA 252, 255, 1106
 - encryption
 - DSA 348, 350, 858
 - RSA 348, 350, 858
 - engine ID 456, 457, 803
 - ERPS
 - configuration guidelines 498, 1120
 - control VLAN 503, 1122
 - domain configuration 500, 1121
 - domain, enabling 502, 1123
 - global configuration 499, 1121
 - guard timer 511, 1124
 - hold-off timer 511, 1124
 - major domain 508, 1125
 - MEG level 503, 1126
 - node identifier 508, 1127
 - non-compliant device protection 510, 1128
 - propagate topology change 510, 1133
 - ring configuration 500, 1121
 - ring port, east interface 501, 1136
 - ring port, west interface 501, 1136
 - ring, enabling 502, 1123
 - RPL owner 503, 1138
 - secondary ring 508, 1125
 - status, displaying 515, 1145
 - wait-to-restore timer 512, 1139
 - WTR timer 512, 1139
 - Ethernet Ring Protection Switching *See* ERPS
 - event logging 422, 759
 - excess burst size, QoS policy 296, 1215, 1217
 - exec command privileges, accounting 318, 319, 323, 840, 844
 - exec settings
 - accounting 318, 845
 - authorization 323, 842, 845

F

fault isolation, CFM 520, 1347, 1379
 fault notification generator, CFM 523, 529, 554,
 1383, 1385
 fault notification, CFM 520, 554, 1347, 1382, 1383,
 1385
 fault verification, CFM 520, 1347
 FIB, description 1469
 firmware
 displaying version 125, 734
 upgrading 129, 738
 upgrading automatically 133, 743
 upgrading with FTP or TFP 133, 738
 version, displaying 125, 734
 forwarding information base See FIB

G

GARP VLAN Registration Protocol See GVRP
 gateway, IPv4 default 1424
 gateway, IPv6 default 644, 1433
 general security measures 309, 889
 GNU license 1481
 GVRP
 enabling 209, 1150
 global setting 209, 1150
 interface configuration 209, 1152

H

hardware version, displaying 125, 734
 HTTP, web server 848
 HTTPS 341, 342, 849
 configuring 341, 849
 replacing SSL certificate 342, 738
 secure-site certificate 342, 738
 UDP port, configuring 342, 848
 HTTPS, secure server 341, 849

I

IEEE 802.1D 239, 1095
 IEEE 802.1s 239, 1095
 IEEE 802.1w 239, 1095
 IEEE 802.1X 387, 862, 865
 IGMP
 authentication, RADIUS 1253
 filter profiles, binding to interface 593, 1255
 filter profiles, configuration 591, 1251
 filter, interface configuration 593, 1253–1257
 filter, parameters 591, 1252
 filtering & throttling 590, 1250
 filtering & throttling, configuring profile 591,
 1251–1252
 filtering & throttling, creating profile 591, 1251
 filtering & throttling, enabling 590, 1251
 filtering & throttling, interface configuration 593,
 1253–1257
 filtering & throttling, status 590, 1251

filtering, configuring profile 591, 1251–1252
 filtering, creating profile 591, 1251
 filtering, group range 591, 1252
 groups, displaying 577, 1244
 Layer 2 568, 1226
 query 568, 570, 1229
 query, enabling 573
 services, displaying 585, 1244
 snooping 568, 1227
 snooping & query, parameters 570, 1226
 snooping, configuring 570, 1226
 snooping, enabling 571, 1251
 snooping, immediate leave 580, 1236
 IGMP snooping
 configuring 578, 1226
 enabling per interface 578, 580, 1227
 forwarding entries 585, 1244
 forwarding priority 573, 1228
 immediate leave, status 580, 1236
 interface attached to multicast router 576, 1245,
 1249
 last leave 570
 last member query count 582, 1237
 last member query interval 582, 1237
 proxy address 582, 1239
 proxy query address 582, 1239
 proxy query interval 581, 1240
 proxy query response interval 582, 1241
 proxy reporting 571, 581, 1228
 querier timeout 573, 1230
 querier, enabling 573
 query interval 581, 1240
 query response interval 582, 1241
 query suppression 570
 router port expire time 573, 1230
 static host interface 570, 1242
 static multicast routing 574, 1249
 static port assignment 576, 1242
 static router interface 569, 1249
 static router port, configuring 574, 1249
 statistics, displaying 586, 1246
 TCN flood 571, 1231
 unregistered data flooding 572, 1232
 version exclusive 573, 1234
 version for interface, setting 581, 1234
 version, setting 573, 1234
 with proxy reporting 570, 1228
 immediate leave
 IGMP snooping 580, 1236
 MLD snooping 597, 1267
 importing user public keys 350, 738
 ingress filtering 206, 1160
 IP address, setting 639, 1421
 IP filter, for management access 383, 878
 IP routing 679, 1467
 configuring interfaces 682
 unicast protocols 682, 1467
 IP statistics 1425

- IPv4 address
 - BOOTP/DHCP 640, 1413, 1422
 - dynamic configuration 92
 - manual configuration 89
 - setting 89, 639, 1422
 - IPv4 source guard
 - configuring static entries 403, 936
 - setting filter criteria 401, 938
 - setting maximum bindings 402, 939, 940
 - IPv6
 - displaying neighbors 654, 1457
 - duplicate address detection 646, 654, 1452, 1457
 - enabling 646, 1439
 - MTU 646, 1441
 - router advertisements, blocking 648, 1454
 - statistics 655, 1445
 - IPv6 address
 - dynamic configuration (global unicast) 93, 651, 1435
 - dynamic configuration (link-local) 93, 646, 1439
 - EUI format 651, 1437
 - EUI-64 setting 651, 1436, 1437
 - explicit configuration 646, 1439
 - global unicast 651, 1434
 - link-local 652, 1435, 1438
 - manual configuration (global unicast) 90, 651, 1434
 - manual configuration (link-local) 90, 652, 1438
 - setting 89, 643, 1434
 - IPv6 source guard
 - configuring static entries 409, 943
 - setting filter criteria 407, 945
 - setting maximum bindings 408, 946
- J**
- jumbo frame 126, 735
- K**
- key
 - SSH - private 344, 853
 - SSH - public 344, 853
 - user public, importing 350, 738
 - key pair
 - host, generating 348, 858
 - host, SSH 344, 853
- L**
- LACP
 - configuration 179, 1021
 - group attributes, configuring 184, 1028
 - group members, configuring 181, 1024–1028
 - local parameters 187, 1030
 - partner parameters 188, 1030
 - protocol message statistics 185, 1030
 - protocol parameters 179, 1021
 - timeout, for LACPDU 180, 1029
 - last member query count, IGMP snooping 582, 1237
 - last member query interval, IGMP snooping 582, 1237
 - layer 2, protocol tunnel 1175
 - license information, GNU 1481
 - Link Layer Discovery Protocol - Media Endpoint Discovery See LLDP-MED
 - Link Layer Discovery Protocol See LLDP
 - link trace cache, CFM 552, 1377, 1378, 1380
 - link trace message, CFM 520, 522, 540, 1347, 1376, 1377, 1379
 - link type, STA 251, 255, 1107
 - LLDP 427, 1323
 - device statistics details, displaying 448, 1346
 - device statistics, displaying 446, 1346
 - display device information 435, 438, 1344
 - displaying remote information 438, 1344
 - interface attributes, configuring 429, 1329–1341
 - local device information, displaying 435, 1343
 - message attributes 429, 1323
 - message statistics 446, 1346
 - remote information, displaying 445, 446, 1344
 - remote port information, displaying 438, 1344
 - timing attributes, configuring 427, 1325–1328
 - TLV 427, 430
 - TLV, 802.1 430, 1332–1334
 - TLV, 802.3 431, 1334–1336
 - TLV, basic 430, 1329–1332
 - TLV, management address 430, 1329
 - TLV, port description 430, 1330
 - TLV, system capabilities 430, 1331
 - TLV, system description 430, 1331
 - TLV, system name 430, 1332
 - LLDP-MED 427, 1323
 - notification, status 430, 1338
 - TLV 431, 1323
 - TLV, extended PoE 431, 1339
 - TLV, inventory 431, 1339
 - TLV, location 431, 1336, 1340
 - TLV, MED capabilities 431, 1340
 - TLV, network policy 431, 1341
 - TLV, PoE 431, 1339
 - load balance, trunk 189, 1022
 - local engine ID 456, 803
 - logging
 - messages, displaying 423, 763
 - syslog traps 424, 762
 - to syslog servers 424, 761
 - log-in, web interface 104
 - logon authentication 326, 823
 - encryption keys 314, 832
 - RADIUS client 313, 830
 - RADIUS server 313, 830
 - sequence 311, 828, 829
 - settings 312, 829
 - TACACS+ client 312, 834
 - TACACS+ server 312, 834
 - logon authentication, settings 314, 830, 834

logon banner, configuring 718
 loop back messages, CFM 520, 522, 542, 1347, 1381
 loopback detection, non-STA 1073
 loopback detection, STA 242, 1107

M

MAC address authentication 331, 895
 ports, configuring 334, 895, 904
 reauthentication 334, 898
 MAC address learning 231, 890
 MAC address, mirroring 237, 1045
 main menu, web interface 106
 maintenance association, CFM 520, 532, 1347, 1356, 1362
 maintenance domain, CFM 520, 521, 527, 1347, 1353, 1362
 maintenance end point, CFM 521, 523, 528, 533, 537, 546, 547, 1355, 1358, 1363
 maintenance intermediate point, CFM 521, 528, 548, 1353, 1354, 1356, 1363
 maintenance level, CFM 521, 522, 1353
 maintenance point, CFM 520, 1347, 1363
 management access, filtering per address 383, 878
 management access, IP filter 383, 878
 Management Information Bases (MIBs) 1477
 matching class settings, classifying QoS traffic 289, 1210
 media-type 156, 1001
 memory
 status 149, 728
 utilization, showing 149, 728
 memory utilization, setting trap 813
 MEP archive, CFM 530, 1370
 mirror port
 configuring 160, 1045
 configuring local traffic 160, 1045
 configuring remote traffic 162, 1048
 mirror trunk
 configuring 160, 1045
 configuring local traffic 1045
 MLD
 filter profiles for IPv6, configuration 1274
 filtering & throttling for IPv6, configuring profile 1274, 1275
 filtering & throttling for IPv6, creating profile 1274
 filtering & throttling for IPv6, enabling 1273
 filtering & throttling for IPv6, interface configuration 1275–1277
 filtering & throttling for IPv6, status 1273
 query 595
 MLD snooping 595, 1262
 configuring 595, 1262
 enabling 596, 1263
 groups, displaying 601, 602
 immediate leave 597, 1267
 immediate leave, status 597, 1267
 interface attached to multicast router 598, 599

 multicast static router port 598, 1268
 querier 596, 1263
 querier, enabling 596, 1263
 query interval 596, 1264
 query, maximum response time 596, 1265
 robustness value 596, 1265
 static port assignment 600, 1269
 static router port 598, 1268
 unknown multicast, handling 596, 1266
 version 596, 1267
 MSTP 239, 257, 1095
 global settings, configuring 243, 257, 1091
 global settings, displaying 249, 1116
 interface settings, configuring 250, 261, 1092
 interface settings, displaying 262, 1116
 max hop count 247, 1100
 path cost 261, 1110
 port priority 1111
 region name 247, 1102
 region revision 247, 1102
 MTU for IPv6 646, 1441
 multicast filtering 567, 1225
 enabling IGMP snooping 571, 580, 1227, 1251
 enabling IGMP snooping per interface 578, 1227
 enabling MLD snooping 596, 1263
 router configuration 574, 1249
 multicast groups 577, 585, 601, 1244
 displaying 577, 585, 601, 1244
 static 576, 577, 600, 601, 1242, 1244
 multicast router discovery 579, 1238
 multicast router port, displaying 576, 599, 1245
 multicast services
 configuring 576, 600, 1242
 displaying 577, 601, 1244
 multicast static router port 574, 1249
 configuring 574, 1249
 configuring for MLD snooping 598, 1268
 multicast storm, threshold 265, 1057
 Multicast VLAN Registration See MVR
 multicast, block on specified ports 584, 1257
 multicast, filtering and throttling 590, 1251
 multicast, filtering and throttling for IPv6 1273
 MVR
 assigning static multicast groups 614, 630, 1284, 1292
 configuring 607, 1281, 1289
 description 603
 interface status, configuring 611, 1290–1292
 interface status, displaying 613, 1293
 IP for control packets sent upstream 608, 1288
 proxy switching 605, 1286
 receiver groups, displaying 1296
 robust value for proxy switching 605, 1287
 setting interface type 612, 1291
 setting multicast domain 607, 612, 1283
 setting multicast groups 607, 608, 1282, 1284
 setting multicast priority 607, 1284, 1305
 specifying a domain 607, 612, 1283
 specifying a VLAN 607, 1282, 1289

- specifying priority 607, 1284, 1305
- static binding 614, 1284, 1292
- static binding, group to port 614, 1292
- statistics, displaying 617, 1298
- using immediate leave 613, 1290

MVR6

- assigning static multicast groups 630, 1306, 1313
- configuring 624, 1303, 1311
- interface status, configuring 628, 1311–1313
- interface status, displaying 630, 1317
- IP for control packets sent upstream 624, 1310
- proxy switching 622, 1307
- receiver groups, displaying 632, 1318
- robust value for proxy switching 622, 1309
- setting interface type 629, 1312
- setting multicast domain 629, 1305
- setting multicast groups 625, 1306
- setting multicast priority 173, 624, 1305
- specifying a domain 629, 1305
- specifying a VLAN 624, 1311
- specifying priority 173, 624, 1305
- static binding 630, 1306, 1313
- static binding, group to port 630, 1313
- statistics, displaying 633, 1320
- using immediate leave 629, 1311

N

ND snooping

- automatic validation 1461–1462
- enabling 1459
- max bindings 1463
- trusted interface 1464

Neighbor Discovery Snooping See ND snooping
network access

- authentication 331, 895
- dynamic QoS assignment 335, 898
- dynamic VLAN assignment 335, 899
- guest VLAN 335, 900
- MAC address filter 335, 897
- port configuration 334, 904
- reauthentication 334, 898
- secure MAC filter, displaying 909
- secure MAC information 339
- secure MAC information, displaying 908

NTP

- authentication keys, specifying 142, 774
- client, enabling 139, 774
- specifying servers 141, 775

NTP, setting the system clock 141, 773–776

O

OAM

- active mode 557, 1393
- displaying settings and status 556, 1397–1400
- enabling on switch ports 556, 1390

- errored frame link events 1391–1392
- event log, displaying 560, 1397
- message statistics, displaying 559, 1397
- mode selection 557, 1393
- passive mode 557, 1393
- remote device information, displaying 561, 1400
- remote loop back test 562, 1396
- setting to active mode 557, 1393
- setting to passive mode 557, 1393

Operations, Administration and Maintenance See OAM

P

- password, line 752
- passwords 88, 824
 - administrator setting 326, 825
- path cost 255, 1105
 - method 245, 1097
 - STA 251, 255, 1097, 1105
- peak burst size, QoS policy 297, 1217
- peak information rate, QoS policy 297, 1217
- per-hop behavior, DSCP ingress map 281, 1202
- policing traffic, QoS policy 291, 295
- policy map
 - description 294, 1209
 - DiffServ 291, 1211
- port authentication 387, 862, 865
- port power
 - displaying status 452, 1041
 - inline 450, 1037
 - inline status 452, 1041
 - maximum allocation 450, 1038
 - priority 452, 1039
 - showing main power 452
 - time range 782, 1040
- port priority
 - configuring 273, 1195
 - default ingress 273, 1198
 - STA 251, 1112
- port security, configuring 385, 890
- ports
 - autonegotiation 157, 1001
 - broadcast storm threshold 263, 264, 1057
 - capabilities 157, 997
 - configuring 156, 995
 - discard CDP/PVST 999
 - duplex mode 157, 1002
 - flow control 157, 1000
 - forced selection on combo ports 156, 1001
 - mirroring 160, 1045
 - mirroring local traffic 160, 1045
 - mirroring remote traffic 162, 1048
 - multicast storm threshold 265, 1057
 - speed 157, 1002
 - statistics 166, 1005
 - transceiver threshold, auto-set 172, 1010
 - transceiver threshold, current 1010
 - transceiver threshold, RX power 173, 1011

- transceiver threshold, temperature 173, 1012
- transceiver threshold, trap 172, 1009
- transceiver threshold, TX power 173, 1013
- transceiver threshold, voltage 173, 1014
- unknown unicast storm threshold 265, 1057
- power budgets
 - port 450, 1038
 - port priority 452, 1039
- power savings
 - configuring 191, 1019
 - enabling per port 191, 1019
- PPPoE 672–677, 880–886
- priority, default port ingress 273, 1198
- private key, SSH 344, 853
- privilege level, defining per command 827
- problems, troubleshooting 1479
- protocol migration 253, 1115
- protocol tunnel, layer 2 1175
- protocol VLANs 220, 1178
 - configuring 221, 1178
 - configuring groups 221, 1179
 - configuring interfaces 222, 1180
 - group configuration 221, 1179
 - interface configuration 222, 1180
- proxy address, IGMP snooping 582, 1239
- proxy ARP 686, 1430
- proxy query address, IGMP snooping 582, 1239
- proxy query interval, IGMP snooping 581, 1240
- proxy query response interval, IGMP snooping 582, 1241
- proxy reporting, IGMP snooping 581, 1228
- public key, SSH 344, 853
- PVID, port native VLAN 205, 1161
- PVST, discard 999

Q

- QinQ Tunneling *See* 802.1Q tunnel
- QoS 287, 1207
 - configuration guidelines 288, 1208
 - configuring 287, 1207
 - CoS/CFI to PHB/drop precedence 283, 1200
 - DSCP to PHB/drop precedence 281, 1202
 - dynamic assignment 335, 898
 - matching class settings 289, 1210
 - PHB to queue 277, 1203
 - selecting DSCP, CoS 280, 1204
- QoS policy
 - committed burst size 295, 296, 297, 1213, 1215, 1217
 - excess burst size 296, 1215
 - peak burst size 297, 1217
 - policing flow 291, 295
 - srTCM 292, 1215
 - srTCM police meter 296, 1215
 - trTCM 293, 1217
 - trTCM police meter 297, 1217
- QoS policy, committed information rate 295, 296, 297, 1213, 1215, 1217

- QoS policy, peak information rate 297, 1217
- Quality of Service *See* QoS
- query interval, IGMP snooping 581, 1240
- query response interval, IGMP snooping 582, 1241
- queue mode, setting 274, 1196
- queue weight, assigning to CoS 275, 1197

R

- RADIUS
 - logon authentication 313, 830
 - settings 313, 830
- rate limit
 - port 263, 1056
 - setting 263, 1055
- remote engine ID 457, 803
- remote logging 424, 762
- remote maintenance end point, CFM 523, 532, 538, 547, 549, 550, 1364, 1365, 1370, 1374
- Remote Monitoring *See* RMON
- rename, DiffServ 1211
- restarting the system 150, 710, 714, 715
 - at scheduled times 150, 710
- RMON 480, 815
 - alarm, displaying settings 483, 820
 - alarm, setting thresholds 481, 816
 - commands 815
 - event settings, displaying 485, 820
 - response to alarm setting 483, 817
 - statistics history, collection 485, 818
 - statistics history, displaying 487, 820
 - statistics, collection 488, 819
 - statistics, displaying 489, 821
- root guard 252, 1113
- routing information base, description 1470
- routing table, displaying 693, 1469
- RSA encryption 348, 350, 858
- RSTP 239, 1095
 - global settings, configuring 243, 1095
 - global settings, displaying 249, 1116
 - interface settings, configuring 250, 1103–1114
 - interface settings, displaying 254, 1116
- running configuration files, displaying 729

S

- secure shell 344, 853
 - configuration 344, 853
- security, general measures 309, 889
- serial port, configuring 145, 748
- service instance, CFM 520, 522, 1356
- Simple Mail Transfer Protocol *See* SMTP
- Simple Network Management Protocol *See* SNMP
- single rate three color meter *See* srTCM
- SMTP
 - event handling 425, 766
 - sending log events 425, 766

- SNMP 452, 793
 - community string 466, 795
 - enabling traps 472, 798
 - filtering IP addresses 383, 878
 - global settings, configuring 454, 795
 - trap manager 472, 799
 - traps, CFM 525, 1369, 1373
 - users, configuring 467, 469
 - SNMPv3 803–805
 - engine ID 456, 457, 803
 - engine identifier, local 456, 803
 - engine identifier, remote 457, 803
 - groups 461, 804
 - local users, configuring 467, 805
 - remote users, configuring 469, 805
 - user configuration 467, 469, 805
 - views 458, 806
 - SNTP
 - setting the system clock 138, 770–772
 - specifying servers 140, 772
 - software
 - displaying version 125, 734
 - downloading 129, 738
 - version, displaying 125, 734
 - Spanning Tree Protocol *See* STA
 - specifications, software 1475
 - srTCM
 - police meter 296, 1215
 - QoS policy 292, 1215
 - SSH 344, 853
 - authentication retries 347, 856
 - authentication, public key 855
 - configuring 344, 853
 - downloading public keys for clients 350, 738
 - generating host key pair 348, 858
 - server, configuring 347, 856
 - timeout 347, 857
 - SSL, replacing certificate 342
 - STA 239, 1091
 - BPDU filter 253, 1103
 - BPDU flooding 245, 250, 1112
 - BPDU shutdown 253, 1104
 - cisco-prestandard, setting compatibility 1093
 - detecting loopbacks 242, 1107
 - edge port 252, 255, 1106
 - forward delay 246, 1093
 - global settings, configuring 243, 1092–1099
 - global settings, displaying 249, 1116
 - hello time 246, 1094
 - interface settings, configuring 250, 1103–1114
 - interface settings, displaying 254, 1116
 - link type 251, 255, 1107
 - loopback detection 242, 1107
 - maximum age 246, 1095
 - MSTP interface settings, configuring 261, 1110, 1111
 - MSTP path cost 261, 1110
 - MSTP port priority 1111
 - path cost 251, 255, 1097, 1105
 - path cost method 245, 1097
 - port priority 251, 1112
 - port/trunk loopback detection 242, 1107
 - protocol migration 253, 1115
 - transmission limit 246, 1099
 - standards, IEEE 1477
 - startup files
 - creating 129, 738
 - displaying 129, 731, 743
 - setting 129, 737
 - static addresses, setting 233, 1086
 - static routes, configuring 691, 1468
 - statistics
 - ARP 690
 - ICMP 1425
 - IP 1425
 - TCP 1425
 - UDP 1425
 - statistics, port 166, 1005
 - STP 244, 1095
 - Also see* STA
 - summary, accounting 319, 846
 - summer time, setting 777–779
 - switch clustering, for management 490, 786
 - switch settings
 - restoring 131, 736
 - saving 131, 736
 - system clock
 - setting 137, 769
 - setting manually 137, 781
 - setting the time zone 144, 780
 - setting with NTP 141, 773–776
 - setting with SNTP 138, 770–772
 - summer time 777–779
 - system logs 422, 761
 - system software, downloading from server 129, 738
- ## T
- TACACS+
 - logon authentication 312, 834
 - logon authentication, encryption keys 315, 835
 - settings 314, 834
 - TCN
 - flood 571, 1231
 - general query solicitation 572, 1232
 - Telnet
 - configuring 147, 850
 - server, enabling 147, 852
 - telnet connection, configuring 146, 748
 - terminal, configuration settings 757
 - TFTP
 - retry count 746
 - timeout 747
 - time range, ACL 353, 782
 - time range, PoE 782, 1040
 - time zone, setting 144, 780
 - time, setting 137, 769
 - TPID 216, 1170

- trace route 684, 1426, 1450
 - traffic segmentation 193, 963
 - assigning ports 193, 963, 964, 965
 - enabling 193, 963, 964, 965
 - sessions, assigning ports 195, 963, 964, 965
 - sessions, creating 194, 963, 964, 965
 - transceiver data, displaying 170, 1015
 - transceiver thresholds
 - configuring 172, 1009
 - displaying 172, 1009, 1016
 - trap manager 98, 472, 799
 - troubleshooting 1479
 - trTCM
 - police meter 297, 1217
 - QoS policy 293, 1217
 - trunk
 - configuration 176, 1021
 - LACP 179, 1021, 1024
 - load balance 189, 1022
 - load balancing 1022
 - static 177, 1024
 - trunks
 - mirroring 160, 1045
 - mirroring local traffic 160, 1045
 - mirroring remote traffic 162, 1048
 - tunneling unknown VLANs, VLAN trunking 196, 1162
 - two rate three color meter *See* trTCM
 - Type Length Value
 - See* LLDP TLV
- ## U
- unicast routing 1467
 - unidirectional link detection 1079
 - unknown unicast storm, threshold 265, 1057
 - unregistered data flooding, IGMP snooping 572, 1232
 - upgrading software 129, 738, 743
 - user account 326, 824, 825
 - user password 326, 824, 825
- ## V
- VLAN
 - L3 interface, setting type 203, 1157
 - VLAN trunking 196, 1162
 - VLANs 199–229, 1149–1192
 - 802.1Q tunnel mode 219, 1167
 - acceptable frame type 206, 1158
 - adding static members 205, 1159
 - basic information, displaying 127, 1153
 - configuring port members, by interface 1158–1161
 - configuring port members, VLAN index 207
 - creating 202, 1156
 - description 199
 - displaying port members 207, 1164
 - displaying port members by interface 208
 - displaying port members by interface range 208
 - displaying port members by VLAN index 207
 - dynamic assignment 335, 899
 - egress mode 205, 1161
 - ingress filtering 206, 1160
 - interface configuration 205, 1158–1162
 - IP subnet-based 225, 1182
 - MAC-based 227, 1184
 - mirroring 229, 1045
 - port members, displaying 207, 1164
 - protocol 220, 1178
 - protocol, configuring 221, 1178
 - protocol, configuring groups 221, 1179
 - protocol, configuring interfaces 222, 1180
 - protocol, group configuration 221, 1179
 - protocol, interface configuration 222, 1180
 - PVID 205, 1161
 - tag swapping 1176
 - tunneling unknown groups 196, 1162
 - voice 303, 1186
 - voice VLANs 303, 1186
 - detecting VoIP devices 304, 1187
 - enabling for ports 307, 1190–1192
 - identifying client devices 305, 1189
 - VoIP traffic 303, 1186
 - ports, configuring 306, 1190–1192
 - telephony OUI, configuring 305, 1189
 - voice VLAN, configuring 304, 1186
 - VoIP, detecting devices 307, 1191
- ## W
- web authentication 328, 912
 - address, re-authenticating 330, 913
 - configuring 329, 912
 - configuring ports 330, 912
 - port information, displaying 330, 331, 914
 - ports, configuring 330, 912
 - ports, re-authenticating 330, 913
 - web interface
 - access requirements 103
 - configuration buttons 105
 - home page 104
 - menu list 106
 - panel display 105

ECS4110-28T
ECS4110-28P
ECS4110-52T
ECS4110-52P

E072014/ST-R02
150200000929A